

## Engine/Cooling/Clutch

## Engine mount

11-14 180 0004

MEM0254

## Notes

Rear  
Rubber-Metal Mount

Inner Diameter [mm]

10

Outer Diameter [mm]

70



## References

Citroën 1809.21

Fiat 9613305380

Lancia 9613305380

Peugeot 1809.29

Citroën 1809.29

Fiat 9637053480

Peugeot 1809.21

## Application info

Citroën Berlingo I (07/96-12/11)

Citroën C5 I / C5 II (03/01--)

Citroën C8 (06/02--)

Citroën Jumpy I (06/94-12/06)

Citroën XM (05/89-10/00)

Citroën Xsara (04/97-03/10)

Citroën ZX (03/91-07/99)

Fiat Scudo II (270) (01/07--)

Fiat Ulysse II (179) (08/02-06/11)

Lancia Zeta (05/95-10/03)

Peugeot 306 (01/93-10/03)

Peugeot 405 (01/87-12/99)

Peugeot 407 (02/04--)

Peugeot 607 (01/00--)

Peugeot 807 (06/02--)

Peugeot Expert II (01/07--)

Peugeot Partner II (04/08--)

Citroën C15 / Visa (09/78-10/06)

Citroën C5 III (RD\_, TD\_) (02/08--)

Citroën Evasion (03/94-10/02)

Citroën Jumpy II (01/07--)

Citroën Xantia (03/93-04/03)

Citroën Xsara Picasso (09/99-06/12)

Fiat Scudo I (220) (02/96-12/06)

Fiat Ulysse I (220) (06/94-08/02)

Lancia Phedra (09/02-11/10)

Peugeot 206 (08/98--)

Peugeot 307 (08/00-12/12)

Peugeot 406 (08/95-02/05)

Peugeot 605 (06/89-09/99)

Peugeot 806 (06/94-02/03)

Peugeot Expert I (07/95-03/08)

Peugeot Partner I (05/96--)

## Steering

## Axial rod

016 030 0001/HD

MAR0484HD

## Notes

Carbon Neutral  
 Front Axle Left  
 Front Axle Right

Length [mm]

246

Required quantity

2

Thread Size 1

M16x1,5

Thread Size 2

M14x1,5

reinforced version

replacement in pairs recommended



## References

Mercedes-Benz 210 338 04 15

Mercedes-Benz A 210 338 04 15

## Application info

Mercedes-Benz BM 210 (E-Class) (06/95-08/03)

## Axial rod

016 030 6338

MAR0001

## Notes

Front Axle Left  
 Front Axle Right

Length [mm]

246

Required quantity

2

Thread Size 1

M16x1,5

Thread Size 2

M14x1,5

replacement in pairs recommended



## References

Mercedes-Benz 210 338 04 15

Mercedes-Benz A 210 338 04 15

## Application info

Mercedes-Benz BM 210 (E-Class) (06/95-08/03)

**Axial rod**

016 031 0001

MAR0003

**Notes**

Front Axle Left  
Front Axle Right

Length [mm] 213  
Required quantity 2  
Thread Size 1 M14x1,5  
Thread Size 2 M12x1,5  
replacement in pairs recommended

**References**

Mercedes-Benz 168 330 13 35

Mercedes-Benz A 168 330 13 35

**Application info**

Mercedes-Benz BM 168 (A-Class) (07/97-08/05)

**Axial rod**

016 031 0002

MAR0004

**Notes**

Front Axle Left  
Front Axle Right

Length [mm] 240  
Required quantity 2  
Thread Size 1 M16x1,5  
Thread Size 2 M14x1,5  
replacement in pairs recommended

**References**

Mercedes-Benz 211 330 29 03

Mercedes-Benz 211 338 00 15

Mercedes-Benz 220 338 07 15

Mercedes-Benz 230 338 00 15

Mercedes-Benz A 211 330 29 03

Mercedes-Benz A 211 338 00 15

Mercedes-Benz A 220 338 07 15

Mercedes-Benz A 230 338 00 15

Mercedes-Benz (BBDC) 230 338 00 15

Mercedes-Benz (BBDC) A 230 338 00 15

**Application info**

Mercedes-Benz BM 203 (C-Class) (05/00-06/11)

Mercedes-Benz BM 209 (CLK) (05/02-03/10)



Mercedes-Benz BM 211 (E-Class) (03/02-07/09)

Mercedes-Benz BM 215 (S-Class) (03/99-12/06)



Mercedes-Benz BM 219 (CLS) (10/04-02/11)





Mercedes-Benz BM 220 (S-Class) (09/98-08/05)

Mercedes-Benz BM 230 (SL) (10/01-01/12)

Axial rod		016 031 0004	MAR0006
<b>Notes</b>  Front Axle Left Front Axle Right  Length [mm] 205 Required quantity 2 Thread Size 1 M14x1,5 replacement in pairs recommended			
<b>References</b> Mercedes-Benz 169 330 08 03 Mercedes-Benz A 169 330 08 03		Mercedes-Benz 169 330 09 03 Mercedes-Benz A 169 330 09 03	
<b>Application info</b> Mercedes-Benz BM 169 (A-Class) (09/04-06/12)		Mercedes-Benz BM 245 (B-Class) (03/05-11/11)	
Axial rod		016 031 0006	MAR0007
<b>Notes</b>  Front Axle Left Front Axle Right  Length [mm] 288 Required quantity 2 Thread Size 1 M16x1,5 Thread Size 2 M16x1,5 replacement in pairs recommended			
<b>References</b> MERCEDES-BENZ (FJDA) 639 460 02 55 Mercedes-Benz 639 460 00 55 Mercedes-Benz A 639 460 00 55		MERCEDES-BENZ (FJDA) A 639 460 02 55 Mercedes-Benz 639 460 02 55 Mercedes-Benz A 639 460 02 55	
<b>Application info</b> Mercedes-Benz BM 639 (Vito / Viano) (08/03-- )			



Axial rod		016 031 0008	MAR0008
<b>Notes</b>  Front Axle Left Front Axle Right  Length [mm] 204 Required quantity 2 Thread Size 1 M16x1,5 Thread Size 2 M14x1,5 replacement in pairs recommended			
<b>References</b> Mercedes-Benz 164 460 00 05		Mercedes-Benz A 164 460 00 05	
<b>Application info</b> Mercedes-Benz BM 164 (GL-Class) (09/06-12/12) Mercedes-Benz BM 251 (R-Class) (08/05-10/17)		Mercedes-Benz BM 164 (M-Class) (02/05-12/12) Mercedes-Benz BM 463 (G-Class) (09/89-- )	
Axial rod		016 031 0009	MAR0009
<b>Notes</b>  Front Axle Left Front Axle Right  Length [mm] 257 Required quantity 2 Thread Size 1 M16x1,5 Thread Size 2 M14x1,5 replacement in pairs recommended			
<b>References</b> Mercedes-Benz 204 338 00 15 Mercedes-Benz 207 338 00 15 Mercedes-Benz A 204 338 04 15 Mercedes-Benz (BBDC) 204 338 00 15 Mercedes-Benz (BBDC) 207 338 00 15 Mercedes-Benz (BBDC) A 204 338 04 15		Mercedes-Benz 204 338 04 15 Mercedes-Benz A 204 338 00 15 Mercedes-Benz A 207 338 00 15 Mercedes-Benz (BBDC) 204 338 04 15 Mercedes-Benz (BBDC) A 204 338 00 15 Mercedes-Benz (BBDC) A 207 338 00 15	
<b>Application info</b> Mercedes-Benz BM 204 (C-Class) (01/07-- )		Mercedes-Benz BM 207 (E-Class) (01/09-12/16)	

Axial rod		016 031 0010	MAR0010
<b>Notes</b>  Front Axle Left Front Axle Right  Length [mm] 260 Required quantity 2 Thread Size 1 M16x1,5 Thread Size 2 M14x1,5 replacement in pairs recommended		 	
<b>References</b> Mercedes-Benz 221 330 16 03		Mercedes-Benz A 221 330 16 03	
<b>Application info</b> Mercedes-Benz BM 216 (S-Class) (05/06-12/13)		Mercedes-Benz BM 221 (S-Class) (09/05-12/13)	
Axial rod		016 031 0011	MAR0011
<b>Notes</b>  Front Axle Left Front Axle Right  Length [mm] 254 Required quantity 2 Thread Size 1 M16x1,5 Thread Size 2 M14x1,5 replacement in pairs recommended		 	
<b>References</b> Mercedes-Benz 212 330 20 00 Mercedes-Benz A 212 330 20 00 Mercedes-Benz (BBDC) 212 330 20 00 Mercedes-Benz (BBDC) A 212 330 20 00		Mercedes-Benz 212 330 21 03 Mercedes-Benz A 212 330 21 03 Mercedes-Benz (BBDC) 212 330 21 03 Mercedes-Benz (BBDC) A 212 330 21 03	
<b>Application info</b> Mercedes-Benz BM 212 (E-Class) (01/09-12/16)			

**Axial rod****016 031 0012****MAR0012****Notes**Front Axle Left  
Front Axle Right

Length [mm]

223

Required quantity

2

Thread Size 1

M14x1,5

Thread Size 2

M14x1,5

replacement in pairs recommended

**References**

Mercedes-Benz 246 338 00 00

Mercedes-Benz A 246 338 00 00

Mercedes-Benz (BBDC) 246 338 00 00

Mercedes-Benz (BBDC) A 246 338 00 00

**Application info**

Mercedes-Benz BM 117 (CLA) (01/13-03/19)

Mercedes-Benz BM 156 (GLA-Class) (12/13--)

Mercedes-Benz BM 176 (A-Class) (06/12-05/18)

Mercedes-Benz BM 246 (B-Class) (10/11-12/18)

**Axial rod****016 031 0013****MAR0373****Notes**Front Axle Left  
Front Axle Right

Length [mm]

244

Required quantity

2

Thread Size 1

M16x1,5

Thread Size 2

M14x1,5

replacement in pairs recommended

**References**

Mercedes-Benz 204 338 03 15

Mercedes-Benz 204 338 05 15

Mercedes-Benz A 204 338 03 15

Mercedes-Benz A 204 338 05 15

Mercedes-Benz (BBDC) 204 338 05 15

Mercedes-Benz (BBDC) A 204 338 05 15

**Application info**

Mercedes-Benz BM 204 (C-Class) (01/07--)

Mercedes-Benz BM 204 (GLK-Class) (06/08-12/15)



Mercedes-Benz BM 207 (E-Class) (01/09-12/16)





Mercedes-Benz BM 212 (E-Class) (01/09-12/16)

Mercedes-Benz BM 216 (S-Class) (05/06-12/13)

Mercedes-Benz BM 221 (S-Class) (09/05-12/13)

Mercedes-Benz BM 222 (S-Class) (05/13--)

Axial rod		016 031 0014	MAR0482
<b>Notes</b>  Front Axle Left Front Axle Right  Length [mm] 270 Required quantity 2 Thread Size 1 M16x1,5 Thread Size 2 M16x1,5 replacement in pairs recommended			
<b>References</b> Mercedes-Benz 166 338 03 15		Mercedes-Benz A 166 338 03 15	
<b>Application info</b> Mercedes-Benz BM 166 (GL) (07/12-12/15) Mercedes-Benz BM 166 (GLS) (11/15-04/19)		Mercedes-Benz BM 166 (GLE) (03/15-10/19) Mercedes-Benz BM 166 (M-Class) (06/11-12/15)	
Axial rod		016 031 0015	MAR0481
<b>Notes</b>  Front Axle Left Front Axle Right  Length [mm] 270 Required quantity 2 Thread Size 1 M16x1,5 Thread Size 2 M14x1,5 replacement in pairs recommended			
<b>References</b> Mercedes-Benz 204 338 06 15		Mercedes-Benz A 204 338 06 15	
<b>Application info</b> Mercedes-Benz BM 172 (SLC) (01/16--) Mercedes-Benz BM 204 (C-Class) (01/07--)		Mercedes-Benz BM 172 (SLK) (01/11--)	

Axial rod		016 031 0016	MAR0471
<b>Notes</b>  Front Axle Left Front Axle Right  Length [mm] 293 Required quantity 2 Thread Size 1 M16x1,5 Thread Size 2 M16X1,5 replacement in pairs recommended		 	
<b>References</b> Mercedes-Benz 222 330 71 00		Mercedes-Benz A 222 330 71 00	
<b>Application info</b> Mercedes-Benz BM 217 (S-Class) (12/15-- )		Mercedes-Benz BM 222 (S-Class) (05/13-- )	
Axial rod		016 031 0017	MAR0483
<b>Notes</b>  Front Axle Left Front Axle Right  Length [mm] 257 Required quantity 2 Thread Size 1 16x1,5 Thread Size 2 14x1,5 replacement in pairs recommended		 	
<b>References</b> Mercedes-Benz 231 330 12 00 Trade number N/A		Mercedes-Benz A 231 330 12 00	
<b>Application info</b> Mercedes-Benz BM 231 (SL) (01/12-- )			

**Axial rod****016 031 0018****MAR0477****Notes**

Front Axle Left  
Front Axle Right

Length [mm] 245  
Required quantity 2  
Thread Size 1 M16X1,5  
Thread Size 2 M14X1,5  
replacement in pairs recommended

**References**

Mercedes-Benz 205 460 08 05

Mercedes-Benz (BBDC) 205 460 08 05

Mercedes-Benz A 205 460 08 05

Mercedes-Benz (BBDC) A 205 460 08 05

**Application info**

Mercedes-Benz BM 205 (C-Class) (12/13--)

Mercedes-Benz BM 238 (E-Class) (06/17--)

Mercedes-Benz BM 213 (E-Class) (01/16--)

Mercedes-Benz BM 257 (CLS-Class) (12/17--)

**Axial rod****016 031 0020/HD****MAR0485HD****Notes**

Carbon Neutral  
Front Axle Left  
Front Axle Right

Length [mm] 265  
Required quantity 2  
Thread Size 1 M16x1,5  
Thread Size 2 M14x1,5  
reinforced version  
replacement in pairs recommended

**References**

Mercedes-Benz 171 338 00 15

Mercedes-Benz A 171 338 00 15

**Application info**

Mercedes-Benz BM 171 (SLK) (03/04-12/11)

## Axial rod

016 031 0021

MAR0589

## Notes

Front Axle Left  
Front Axle Right

Length [mm] 239  
Required quantity 2  
Thread Size 1 M16X1,5  
Thread Size 2 M14X1,5  
replacement in pairs recommended



## References

Mercedes-Benz 205 460 04 05  
Mercedes-Benz A 205 460 04 05  
Mercedes-Benz (BBDC) 205 460 04 05

Mercedes-Benz 205 460 48 02  
Mercedes-Benz A 205 460 48 02  
Mercedes-Benz (BBDC) A 205 460 04 05

## Application info

Mercedes-Benz BM 205 (C-Class) (12/13--)  
Mercedes-Benz BM 238 (E-Class) (06/17--)  
Mercedes-Benz BM 257 (CLS-Class) (12/17--)

Mercedes-Benz BM 213 (E-Class) (01/16--)  
Mercedes-Benz BM 253 (GLC) (06/15--)  
Mercedes-Benz BM 293 (EQC) (05/19--)

## Axial rod

016 031 0022

MAR0590

## Notes

Front Axle Left  
Front Axle Right

Length [mm] 246  
Required quantity 2  
Thread Size 1 M16x1,5  
Thread Size 2 M16x1,5  
replacement in pairs recommended



## References

MERCEDES-BENZ (FJDA) 447 460 00 55  
Mercedes-Benz 447 460 00 55

MERCEDES-BENZ (FJDA) A 447 460 00 55  
Mercedes-Benz A 447 460 00 55

## Application info

Mercedes-Benz BM 447 (V-Class) (03/14--)

Mercedes-Benz BM 447 (Vito) (10/14--)

**Axial rod****016 031 0023****MAR0594****Notes**

Front Axle Left  
Front Axle Right

Length [mm] 232  
Required quantity 2  
Thread Size 1 M16x1,5  
Thread Size 2 M14x1,5  
replacement in pairs recommended

**References**

Mercedes-Benz 212 330 28 03  
Mercedes-Benz (BBDC) 212 330 28 03

Mercedes-Benz A 212 330 28 03  
Mercedes-Benz (BBDC) A 212 330 28 03

**Application info**

Mercedes-Benz BM 204 (GLK-Class) (06/08-12/15)  
Mercedes-Benz BM 212 (E-Class) (01/09-12/16)  
Mercedes-Benz BM 218 (CLS) (01/11-12/17)

Mercedes-Benz BM 207 (E-Class) (01/09-12/16)  
Mercedes-Benz BM 217 (S-Class) (12/15--)  
Mercedes-Benz BM 222 (S-Class) (05/13--)

**Axial rod****016 031 0024****MAR0595****Notes**

Front Axle Left  
Front Axle Right

Length [mm] 246  
Required quantity 2  
Thread Size 1 M16x1,5  
Thread Size 2 M14x1,5  
replacement in pairs recommended

**References**

Mercedes-Benz 207 330 05 00  
Mercedes-Benz (BBDC) 207 330 05 00



Mercedes-Benz A 207 330 05 00  
Mercedes-Benz (BBDC) A 207 330 05 00

**Application info**

Mercedes-Benz BM 204 (C-Class) (01/07--)

Mercedes-Benz BM 207 (E-Class) (01/09-12/16)



Axial rod		016 031 0025	MAR0631
<b>Notes</b>  Front Axle Left Front Axle Right  Length [mm] 218 Required quantity 2 Thread Size 1 M14x1,5 Thread Size 2 M14x1,5 replacement in pairs recommended			
<b>References</b> Mercedes-Benz 247 338 00 00		Mercedes-Benz A 247 338 00 00	
<b>Application info</b> Mercedes-Benz BM 118 (CLA) (03/19--) Mercedes-Benz BM 243 (EQA) (02/21--) Mercedes-Benz BM 247 (GLA-Class) (02/20--)		Mercedes-Benz BM 177 (A-Class) (03/18--) Mercedes-Benz BM 243 (EQB) (12/21--)	
Axial rod		016 031 0026	MAR0632
<b>Notes</b>  Front Axle Left Front Axle Right  Length [mm] 202 Required quantity 2 Thread Size 1 M14x1,5 Thread Size 2 M14x1,5 replacement in pairs recommended			
<b>References</b> Mercedes-Benz 177 338 00 00 Mercedes-Benz (BBDC) 177 338 00 00		Mercedes-Benz A 177 338 00 00 Mercedes-Benz (BBDC) A 177 338 00 00	
<b>Application info</b> Mercedes-Benz BM 177 (A-Class) (03/18--)		Mercedes-Benz BM 247 (B-Class) (12/18--)	

**Axial rod**

016 031 0027/HD

MAR0652HD

**Notes**

Carbon Neutral  
 Front Axle Left  
 Front Axle Right

Length [mm]

316.5

Required quantity

2

Thread Size 1

M16x1,5

Thread Size 2

M16x1,5

reinforced version

replacement in pairs recommended

**References**

Mercedes-Benz 907 460 63 00

Mercedes-Benz A 907 460 63 00

**Application info**

Mercedes-Benz BM 907 / 910 (Sprinter III) (02/18--)

**Axial rod**

016 031 0028/HD

MAR0653HD

**Notes**

Carbon Neutral  
 Front Axle Left  
 Front Axle Right

Length [mm]

238

Required quantity

2

Thread Size 1

M16x1,5

Thread Size 2

M16x1,5

replacement in pairs recommended

**References**

Mercedes-Benz 910 460 62 00

Mercedes-Benz A 910 460 62 00

**Application info**

Mercedes-Benz BM 907 / 910 (Sprinter III) (02/18--)

**Axial rod**

036 030 0017

MAR0013

**Notes**

Front Axle Left  
Front Axle Right

Length [mm] 335  
Required quantity 2  
Thread Size 1 M16x1,5  
Thread Size 2 M16x1,5  
replacement in pairs recommended

**References**

Mercedes-Benz 638 460 00 55  
Mercedes-Benz 638 460 02 55  
Mercedes-Benz A 638 460 02 05

Mercedes-Benz 638 460 02 05  
Mercedes-Benz A 638 460 00 55  
Mercedes-Benz A 638 460 02 55

**Application info**

Mercedes-Benz BM 638 (V-Class / Vito) (02/96-07/03)

**Axial rod**

036 030 0021

MAR0014

**Notes**

Front Axle Left  
Front Axle Right

Length [mm] 382  
Required quantity 2  
Thread Size 1 M16x1,5  
Thread Size 2 M16x1,5  
replacement in pairs recommended

**References**



Mercedes-Benz 901 460 01 55  
Mercedes-Benz 901 460 02 55  
Mercedes-Benz A 901 460 01 55  
Mercedes-Benz A 901 460 02 55  
Volkswagen 2D0 422 803

Mercedes-Benz 901 460 02 05  
Mercedes-Benz 901 460 04 55  
Mercedes-Benz A 901 460 02 05  
Mercedes-Benz A 901 460 04 55

**Application info**

Mercedes-Benz BM 901 / 902 (Sprinter I) (01/95-05/06)  
Mercedes-Benz BM 904 (Sprinter I) (02/95-05/12)  
Volkswagen LT II (04/96-07/06)

Mercedes-Benz BM 903 (Sprinter I) (01/95-05/12)  
Mercedes-Benz BM 909 (Sprinter) (09/13--)

Axial rod		11-16 030 0001	MAR0015
<b>Notes</b>  Front Axle Left Front Axle Right  Length [mm] 338 Required quantity 2 Thread Size 1 M12x1 Thread Size 2 M14x1,5 replacement in pairs recommended			
<b>References</b> CITROËN (DF-PSA) 3812.C0 Citroën 3812.C0 Citroën 3812.C6 Citroën 3812.E4 Citroën 96 048 214 Peugeot 3812.C0 Peugeot 3812.C6 Peugeot 3812.E4 Peugeot (DF-PSA) 3812.C0			
<b>Application info</b> Citroën Berlingo I (07/96-12/11) Citroën Xsara (04/97-03/10) Citroën Xsara Picasso (09/99-06/12) Citroën ZX (03/91-07/99) Peugeot Partner I (05/96--) Peugeot Partner II (04/08--)			
Axial rod		11-16 030 0008/HD	MAR0486HD
<b>Notes</b>  Carbon Neutral Front Axle Left Front Axle Right  Length [mm] 315 Required quantity 2 Thread Size 1 M16x1,5 Thread Size 2 M16x1,5 reinforced version replacement in pairs recommended			
<b>References</b> Citroën 14 716 540 80 Citroën 4018.A4 Fiat 9945836 Peugeot 4018.A4			

**Application info**

Citroën Jumper I (02/94-08/02)

Fiat Ducato (230) (03/94-05/05)

Peugeot Boxer I (03/94-08/05)

Citroën Jumper II (02/02--)

Fiat Ducato (244) (04/02--)

Peugeot Boxer II (12/01--)

**Axial rod**

11-16 030 5749

MAR0016

**Notes**Front Axle Left  
Front Axle Right

Length [mm]

314

Required quantity

2

Thread Size 1

M12x1

Thread Size 2

M14x1,5

replacement in pairs recommended

**References**

Citroën 16 109 385 80

Peugeot 16 10 938 580

Peugeot 3812.52

Peugeot 3812.94

Citroën 96 136 394

Peugeot 3812.25

Peugeot 3812.65

Peugeot 3812.97

**Application info**

Citroën C15 / Visa (09/78-10/06)

Peugeot 205 (02/83-12/00)

Citroën Xantia (03/93-04/03)

Peugeot 309 (10/85-12/93)

**Axial rod**

11-16 030 6907

MAR0017

**Notes**Front Axle Left  
Front Axle Right

Length [mm]

355

Required quantity

2

Thread Size 1

M12x1

Thread Size 2

M14x1,5

replacement in pairs recommended

**References**

Peugeot 16 07 293 080

Peugeot 3812.92

**Application info**

Peugeot 306 (01/93-10/03)

**Axial rod**

11-16 030 7528

MAR0018

**Notes**

Front Axle Left  
Front Axle Right

Length [mm] 315  
Required quantity 2  
Thread Size 1 M16x1,5  
Thread Size 2 M16x1,5  
replacement in pairs recommended

**References**

Citroën 14 716 540 80  
Citroën 4018.A4  
Peugeot 16 07 292 780

Citroën 16 072 927 80  
Fiat 9945836  
Peugeot 4018.A4

**Application info**

Citroën Jumper I (02/94-08/02)  
Fiat Ducato (230) (03/94-05/05)  
Peugeot Boxer I (03/94-08/05)

Citroën Jumper II (02/02--)  
Fiat Ducato (244) (04/02--)  
Peugeot Boxer II (12/01--)

**Axial rod**

11-16 031 0000

MAR0019

**Notes**

Front Axle Left  
Front Axle Right  
for vehicles with power steering



Length [mm] 300  
Required quantity 2  
Thread Size 1 M16x1,5  
Thread Size 2 M16x1,5  
replacement in pairs recommended





**References**

Peugeot 3812.C4



**Application info**





Peugeot 406 (08/95-02/05)





Axial rod		11-16 031 0001	MAR0020
<b>Notes</b>  Front Axle Left Front Axle Right for vehicles with power steering  Length [mm] 300 Required quantity 2 Thread Size 1 M14x1,5 Thread Size 2 M14x1,5 replacement in pairs recommended			
<b>References</b> Peugeot 3812.C5			
<b>Application info</b> Peugeot 206 (08/98--)			
Axial rod		11-16 031 0007	MAR0022
<b>Notes</b>  Front Axle Left Front Axle Right  Length [mm] 212 Required quantity 2 Thread Size 1 M12x1 Thread Size 2 M16x1,5 replacement in pairs recommended			
<b>References</b> Citroën 3812.E8 Peugeot 3812.E8			
<b>Application info</b> Citroën C3 Picasso (02/09--) Peugeot 207 (02/06--)			



Axial rod		11-16 031 0008	MAR0023
<b>Notes</b>  Front Axle Left Front Axle Right  Length [mm] 122 Required quantity 2 Thread Size 1 M16x1,5 Thread Size 2 M14x1,5 replacement in pairs recommended		  	
<b>References</b> Citroën 3812.E3 Peugeot 3812.E3		Citroën 3812.E7 Peugeot 3812.E7	
<b>Application info</b> Citroën C6 (09/05-12/12)		Peugeot 407 (02/04--)	
Axial rod		11-16 031 0009	MAR0024
<b>Notes</b>  Front Axle Left Front Axle Right  Length [mm] 235 Required quantity 2 Thread Size 1 M12x1 Thread Size 2 M14x1,5 replacement in pairs recommended		  	
<b>References</b> Citroën 3812.E1		Peugeot 3812.E1	
<b>Application info</b> Citroën C2 / C3 I / Pluriel (02/02--)		Peugeot 1007 (04/05--)	



Axial rod		11-16 031 0010	MAR0025
<b>Notes</b>  Front Axle Left Front Axle Right  Length [mm] 295 Required quantity 2 Thread Size 1 M16x1,5 Thread Size 2 M16x1,5 replacement in pairs recommended			
<b>References</b> Peugeot 3812.C7			
<b>Application info</b> Peugeot 607 (01/00--)			
Axial rod		11-16 031 0011/HD	MAR0487HD
<b>Notes</b>  Carbon Neutral Front Axle Left Front Axle Right  Length [mm] 235 Required quantity 2 Thread Size 1 M12x1 Thread Size 2 M14x1,5 reinforced version replacement in pairs recommended			
<b>References</b> Citroën 3812.E1 Peugeot 3812.E1			
<b>Application info</b> Citroën C2 / C3 I / Pluriel (02/02--) Peugeot 1007 (04/05--)			

Axial rod		11-16 031 0012/HD	MAR0488HD
<b>Notes</b>  Carbon Neutral Front Axle Left Front Axle Right  Length [mm] 255 Required quantity 2 Thread Size 1 M16x1,5 Thread Size 2 M16x1,5 reinforced version replacement in pairs recommended		  	
<b>References</b> Citroën 4001 A1 Citroën 4001 E5 Fiat 1359226080 Peugeot 4001 A1 Peugeot 4001 E5		Citroën 4001 E4 Fiat 1359225080 Fiat 1359227080 Peugeot 4001 E4	
<b>Application info</b> Citroën Jumper III (04/06--) Peugeot Boxer III (09/05--)		Fiat Ducato (250) (07/06--)	
Axial rod		11-16 031 0013/HD	MAR0489HD
<b>Notes</b>  Carbon Neutral Front Axle Left Front Axle Right  Length [mm] 345 Required quantity 2 Thread Size 1 M14x1,5 Thread Size 2 M14x1,5 reinforced version replacement in pairs recommended		  	
<b>References</b> Citroën 3812.F1 Peugeot 3812.F1		Mitsubishi 4422A012	
<b>Application info</b> Citroën C-Crosser (02/07--) Mitsubishi Outlander II (11/06-12/12)		Mitsubishi Lancer VIII (03/07--) Peugeot 4007 (02/07-03/13)	

Axial rod		11-16 031 0014/HD	MAR0490HD
<b>Notes</b>  Carbon Neutral Front Axle Left Front Axle Right  Length [mm] 225 Required quantity 2 Thread Size 1 M12x1 Thread Size 2 M14x1,5 reinforced version replacement in pairs recommended		 	
<b>References</b> Citroën 16 080 253 80		Peugeot 16 08 025 380	
<b>Application info</b> Citroën C4 Cactus (09/14--) Peugeot 208 I (03/12--)		Peugeot 2008 I (03/13--)	
Axial rod		11-16 031 0015	MAR0026
<b>Notes</b>  Front Axle Left Front Axle Right  Length [mm] 320 Required quantity 2 Thread Size 1 M14x1,5 Thread Size 2 M14x1,5 replacement in pairs recommended		 	
<b>References</b> CITROËN (DF-PSA) 3812.E0 Peugeot 3812.E0		Citroën 3812.E0 Peugeot (DF-PSA) 3812.E0	
<b>Application info</b> Citroën C4 I / Coupe / Grand Picasso / Picasso / Stufenheck (11/04--) Peugeot 307 (08/00-12/12)			

Axial rod		11-16 031 0017	MAR0028
<b>Notes</b>  Front Axle Left Front Axle Right for vehicles with power steering  Length [mm] 192 Required quantity 2 Thread Size 1 M12x1 Thread Size 2 M16x1,5 replacement in pairs recommended			
<b>References</b> Citroën 3812.A6		Peugeot 3812.A6	
<b>Application info</b> Citroën XM (05/89-10/00) Peugeot 605 (06/89-09/99)		Citroën Xantia (03/93-04/03) Peugeot 607 (01/00--)	
Axial rod		11-16 031 0019	MAR0029
<b>Notes</b>  Front Axle Left Front Axle Right  Length [mm] 341 Required quantity 2 Thread Size 1 M14x1,5 Thread Size 2 M14x1,5 replacement in pairs recommended			
<b>References</b> CITROËN (DF-PSA) 3812.E5 Citroën 3812.E5 Peugeot 3812.E5		Citroën 16 072 917 80 Peugeot 16 07 291 780 Peugeot (DF-PSA) 3812.E5	
<b>Application info</b> Citroën C4 I / Coupe / Grand Picasso / Picasso / Stufenheck (11/04--)		Peugeot 307 (08/00-12/12)	

## Axial rod

11-16 031 0020

MAR0030

## Notes

Front Axle Left  
Front Axle Right

Length [mm] 305  
Required quantity 2  
Thread Size 1 M16x1,5  
Thread Size 2 M14x1,5  
replacement in pairs recommended



## References

Citroën 3812.F0  
Fiat 1400931580  
Fiat 1401381380  
Peugeot 3812.F0

Fiat 1400931480  
Fiat 1401381280  
Fiat 1497550080  
Toyota SU001-A2961

## Application info

Citroën C8 (06/02--)  
Fiat Scudo II (270) (01/07--)  
Peugeot Expert II (01/07--)

Citroën Jumpy II (01/07--)  
Peugeot 807 (06/02--)  
Toyota Proace I (06/13-03/16)

## Axial rod

11-16 031 0021

MAR0031

## Notes

Front Axle Left  
Front Axle Right

Length [mm] 271  
Required quantity 2  
Thread Size 1 M14x1,5  
Thread Size 2 M14x1,5  
replacement in pairs recommended



## References

Citroën 3812.F2  
Peugeot 3812.F2



DS 3812 F2

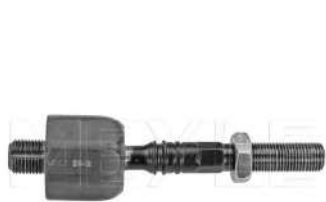

## Application info

Citroën C4 II / DS4 (02/09--)  
Peugeot 3008 I (05/09-12/17)  
Peugeot 5008 I (06/09-03/17)



DS DS 4 I (07/15-12/18)  
Peugeot 308 I (09/07--)

Axial rod		11-16 031 0022	MAR0032
<b>Notes</b>  Front Axle Left Front Axle Right  Length [mm] 255 Required quantity 2 Thread Size 1 M16x1,5 Thread Size 2 M16x1,5 replacement in pairs recommended			
<b>References</b> Citroën 4001.A1 Citroën 4001.E4 Citroën 4001.E5 Fiat 1359225080 Fiat 1359226080 Fiat 1359227080 Peugeot 4001.A1 Peugeot 4001.E4 Peugeot 4001.E5			
<b>Application info</b> Citroën Jumper III (04/06--) Peugeot Boxer III (09/05--) Fiat Ducato (250) (07/06--)			
Axial rod		11-16 031 0023	MAR0033
<b>Notes</b>  Front Axle Left Front Axle Right  Length [mm] 129 Required quantity 2 Thread Size 1 M16x1,5 Thread Size 2 M14x1,5 replacement in pairs recommended			
<b>References</b> Citroën 3812.F3 Peugeot 3812.F3			
<b>Application info</b> Citroën C5 III (RD_, TD_) (02/08--) Peugeot 508 I (11/10--)			

Axial rod		11-16 031 0024	MAR0034
<b>Notes</b>  Front Axle Left Front Axle Right  Length [mm] 260 Required quantity 2 Thread Size 1 M14x1,5 Thread Size 2 M14x1,5 replacement in pairs recommended			
<b>References</b> Citroën 3812.F4 Peugeot 3812.F4			
<b>Application info</b> Citroën Berlingo II (04/08--) Peugeot Partner II (04/08--)			
Axial rod		11-16 031 0025	MAR0035
<b>Notes</b>  Front Axle Left Front Axle Right  Length [mm] 310 Required quantity 2 Thread Size 1 M14x1,5 Thread Size 2 M16x1,5 replacement in pairs recommended			
<b>References</b> Citroën 16 109 359 80 Citroën 3812.E9			
<b>Application info</b> Citroën C4 I / Coupe / Grand Picasso / Picasso / Stufenheck (11/04--)			

Axial rod		11-16 031 0026	MAR0036
<b>Notes</b>  Front Axle Left Front Axle Right  Length [mm] 225 Required quantity 2 Thread Size 1 M14x1,5 Thread Size 2 M12x1,25 replacement in pairs recommended			
<b>References</b> Citroën 4001.33 Peugeot 4001.33 Toyota 45500-0H010			
<b>Application info</b> Citroën C1 (06/05-09/14) Peugeot 107 (06/05-05/14) Toyota Aygo I (02/05-05/14)			
Axial rod		11-16 031 0028	MAR0038
<b>Notes</b>  Front Axle Left Front Axle Right  Length [mm] 205 Required quantity 2 Thread Size 1 M16x1,5 Thread Size 2 M14x1,5 replacement in pairs recommended			
<b>References</b> Peugeot 16 07 142 380 Peugeot 3812.G3			
<b>Application info</b> Peugeot 508 I (11/10--)			



<b>Axial rod</b>		<b>11-16 031 0030</b>	<b>MAR0039</b>
<b>Notes</b>  Front Axle Left Front Axle Right  Length [mm] 390 Required quantity 2 Thread Size 1 M14x1,5 Thread Size 2 M14x1,5 replacement in pairs recommended			
<b>References</b> Citroën 16 109 425 80 DS 3812 F7 Peugeot 3812.F7 Citroën 3812.F7 Peugeot 16 10 942 580			
<b>Application info</b> Citroën DS5 (09/11-07/15) Peugeot RCZ (03/10-12/15) DS DS 5 (04/15-12/18)			
<b>Axial rod</b>		<b>11-16 031 0031</b>	<b>MAR0040</b>
<b>Notes</b>  Front Axle Left Front Axle Right  Length [mm] 225 Required quantity 2 Thread Size 1 M12x1 Thread Size 2 M14x1,5 replacement in pairs recommended			
<b>References</b> Citroën 16 080 253 80 Peugeot 16 08 025 380			
<b>Application info</b> Citroën C4 Cactus (09/14--) Peugeot 208 I (03/12--) Peugeot 2008 I (03/13--)			

**Axial rod**

11-16 031 0032

MAR0374

**Notes**

Front Axle Left  
Front Axle Right

Length [mm] 342

Required quantity 2

Thread Size 1 M14x1.5

Thread Size 2 M14X1.5

replacement in pairs recommended

**References**

Citroën 16 085 321 80

Mitsubishi 4422A076

Mitsubishi 4422A058

Peugeot 16 085 321 80

**Application info**

Citroën C4 AIRCROSS (08/10--)

Mitsubishi Lancer VIII (03/07--)

Peugeot 4008 (05/12--)

Mitsubishi ASX I (11/09--)

Mitsubishi Outlander III (11/10--)

**Axial rod**

11-16 031 0034/HD

MAR0491HD

**Notes**

Carbon Neutral  
Front Axle Left  
Front Axle Right

Length [mm] 225

Required quantity 2

Thread Size 1 M14x1,5

Thread Size 2 M12x1,25

reinforced version

replacement in pairs recommended

**References**

Citroën 4001.33

Toyota 45500-0H010

Peugeot 4001.33

**Application info**

Citroën C1 (06/05-09/14)

Toyota Aygo I (02/05-05/14)

Peugeot 107 (06/05-05/14)

## Axial rod

11-16 031 0035/HD

MAR0565HD

## Notes

Carbon Neutral  
Front Axle Left  
Front Axle Right

Length [mm]

264

Required quantity

2

Thread Size 1

M16x1,5

Thread Size 2

M14x1,5

reinforced version

replacement in pairs recommended



## References

Citroën 98 203 402 80

Opel 98 20 340 280

Peugeot 98 20 340 280

Toyota SU001-A7257

## Application info

Citroën Jumpy III (04/16--)

Citroën Spacetourer (04/16--)

Opel Vivaro C (03/19--)

Peugeot Expert III (04/16--)

Peugeot Traveller (04/16--)

Toyota Proace II (02/16--)

## Axial rod

11-16 031 0036

MAR0586

## Notes

Front Axle Left  
Front Axle Right

Length [mm]

229

Required quantity

2

Thread Size 1

M14x1,5

Thread Size 2

M14x1,5

replacement in pairs recommended



## References

Citroën 16 231 408 80

DS 16 231 408 80

## Application info

Citroën C3 II (09/09--)

Citroën C3 III (07/16--)

DS DS 3 (04/15-07/19)

**Axial rod**

11-16 031 0037/HD

MAR0584HD

**Notes**

Carbon Neutral  
 Front Axle Left  
 Front Axle Right

Length [mm]

204

Required quantity

2

Thread Size 1

M14x1,5

Thread Size 2

M14x1,5

reinforced version

replacement in pairs recommended

**References**

Citroën 16 112 423 80

Opel 16 112 423 80

Peugeot 16 11 242 380

Vauxhall 16 112 423 80

**Application info**

Citroën Berlingo III (06/18--)

Opel Combo E (K9) (06/18--)

Peugeot 308 I (09/07--)

Peugeot 308 II (09/13--)

Peugeot Rifter (09/18--)

Vauxhall Combo Mk IV (06/18--)

**Axial rod**

11-16 031 0039

MAR0655

**Notes**

Front Axle Left  
 Front Axle Right

Length [mm]

201

Required quantity

2

Thread Size 1

M14x1,5

Thread Size 2

M14x1,5

replacement in pairs recommended

**References**

Citroën 16 488 366 80

Citroën 16 488 367 80

Opel 16 488 367 80

Peugeot 16 48 836 680



Peugeot 16 48 836 780

**Application info**

Citroën Berlingo III (06/18--)

Opel Combo E (K9) (06/18--)

Peugeot Rifter (09/18--)

Axial rod		116 030 0002	MAR0041
<b>Notes</b>  Front Axle Left Front Axle Right for vehicles with power steering  Length [mm] 320 Required quantity 2 Thread Size 1 M14x1,5 Thread Size 2 M14x1,5 replacement in pairs recommended			
<b>References</b> Seat 6K0 422 803 B Seat 6K0 422 804 B Volkswagen 6K0 422 803 B Volkswagen 6K0 422 804 B		Seat 6K0 422 803 E Seat 6K0 422 804 E Volkswagen 6K0 422 803 E Volkswagen 6K0 422 804 E	
<b>Application info</b> Seat Ibiza II / Cordoba I / Inca (6K_) (02/93-11/03) Volkswagen Polo (6K_) (01/95-11/09)		Volkswagen Caddy II (9K9, 9K9B, 9U7) (11/95-06/09) Volkswagen Polo Playa (01/95-11/09)	
Axial rod		116 030 3235	MAR0043
<b>Notes</b>  Front Axle Left Front Axle Right for vehicles without power steering  Length [mm] 340 Required quantity 2 Thread Size 1 M22x1,5 Thread Size 2 M14x1,5 replacement in pairs recommended			
<b>References</b> Volkswagen 171 419 804 Volkswagen 171 419 821 A		Volkswagen 171 419 821	
<b>Application info</b> Volkswagen Caddy I (14) (08/79-07/92) Volkswagen Jetta I (16) (08/78-12/87) Volkswagen Scirocco II (53B) (08/80-07/92)		Volkswagen Golf I (17, 155) (04/74-08/93) Volkswagen Scirocco I (53) (02/74-07/80)	

**Axial rod****116 030 4680****MAR0046****Notes**

Front Axle Left  
Front Axle Right

Length [mm] 128  
Required quantity 2  
Thread Size 1 M16x1,5  
Thread Size 2 M14x1,5  
replacement in pairs recommended

**References**

Audi 4B0 419 821 G	Audi 4D0 419 821 Q
Audi 4D0 422 821	Audi 4D0 422 821 A
Audi 8E0 419 801 B	Audi 8E0 422 821
Audi 8E0 422 821 B	Audi 8E0 422 821 C
Audi 8E0 422 821 D	Audi (FAW) 4D0 422 821 A
Audi (FAW) 8E0 422 821	Audi (FAW) 8E0 422 821 C
Seat 8E0 422 821 C	Skoda 4B0 419 801 M
Volkswagen 4D0 422 821 A	Volkswagen (SVW) 4D0 422 821 A

**Application info**

Audi A4 Cabriolet (8H_) (01/02-12/09)	Audi A4 I (8D_) (11/94-12/02)
Audi A4 II (8E_) (02/00-12/05)	Audi A4 III (8E_) (11/04-06/08)
Audi A6 II (4B, C5) (01/97-12/05)	Audi A6 III (4F2, 4FH, 4F5) (04/04-08/11)
Audi A8 I (4D_) (03/94-12/05)	Audi Allroad (4BH) (05/00-08/05)
Seat Exeo (3R) (12/08-05/13)	Skoda Superb I (3U) (12/01-03/08)
Volkswagen Passat (3B_) (08/96-12/05)	

**Axial rod****116 030 7159****MAR0050****Notes**

Front Axle Left  
Front Axle Right  
for vehicles with power steering

Length [mm] 355  
Manufacturer Restriction TRW  
Required quantity 2  
Thread Size 1 M14x1,5  
Thread Size 2 M14x1,5  
replacement in pairs recommended



**References**

Volkswagen 357 422 803

Volkswagen 357 422 804

**Application info**

Volkswagen Passat (35l) (02/88-12/97)

**Axial rod**

116 030 7181

MAR0051

**Notes**

Front Axle Left  
 Front Axle Right  
 for vehicles without power steering

Length [mm]

381

Required quantity

2

Thread Size 1

M22x1,5

Thread Size 2

M14x1,5

replacement in pairs recommended

**References**

Volkswagen 1H0 419 803

Volkswagen 1H0 419 803 A

Volkswagen 1H0 419 804

Volkswagen 1H0 419 804 A

Volkswagen 1H0 419 821 A

**Application info**

Volkswagen Golf III (1H1, 1H5, 1E7) (10/89-12/02)

Volkswagen Vento (11/91-09/98)

**Axial rod**

116 030 7184

MAR0052

**Notes**

Front Axle Left  
 Front Axle Right  
 for vehicles with power steering

Length [mm]

369

Manufacturer Restriction

TRW

Required quantity

2

Thread Size 1

M14x1,5

Thread Size 2

M14x1,5

replacement in pairs recommended

**References**

Seat 1H0 422 804 A

Volkswagen 1H0 422 803

Volkswagen 1H0 422 803 A

Volkswagen 1H0 422 804

Volkswagen 1H0 422 804 A

Volkswagen 1H0 422 807

Volkswagen 1H0 422 807 D

**Application info**

Seat Toledo I (1L\_) (01/91-10/99)

Volkswagen Golf III (1H1, 1H5, 1E7) (10/89-12/02)

Volkswagen Corrado (53I) (08/87-12/95)

Volkswagen Vento (11/91-09/98)

**Axial rod****116 030 7185****MAR0053****Notes**

Front Axle Left  
 Front Axle Right  
 for vehicles with power steering

Length [mm]

363

Manufacturer Restriction

ZF

Required quantity

2

Thread Size 1

M14x1,5

Thread Size 2

M14x1,5

replacement in pairs recommended

**References**

Volkswagen 191 422 821 C

Volkswagen 1H0 422 804 B

Volkswagen 1H0 422 821 C

Volkswagen 1H0 422 803 B

Volkswagen 1H0 422 821 B

**Application info**

Volkswagen Corrado (53I) (08/87-12/95)

Volkswagen Vento (11/91-09/98)

Volkswagen Golf III (1H1, 1H5, 1E7) (10/89-12/02)

**Axial rod****116 030 8200****MAR0055****Notes**

Length [mm]

294

Required quantity

2

Thread Size 1

M14x1,5

Thread Size 2

M16x1,5

replacement in pairs recommended

**References**

Volkswagen 701 419 804 C

Volkswagen 701 419 810 B

Volkswagen 701 419 821 C

Volkswagen 701 419 810 A

Volkswagen 701 419 821

Volkswagen 702 419 803 A

**Application info**

Volkswagen Transporter IV (07/90-06/03)



**Axial rod**

116 030 8254

MAR0056

**Notes**

Front Axle Left  
 Front Axle Right  
 for vehicles with power steering

Length [mm] 182  
 Required quantity 2  
 Thread Size 1 M14x1,5  
 Thread Size 2 M14x1,5  
 replacement in pairs recommended

**References**

Ford 1 001 395	Ford 1 001 396
Ford 1 020 496	Ford 1 092 376
Ford 1 092 382	Ford 1 121 508
Ford 1 233 552	Ford 1 233 553
Ford 7 200 944	Ford 7 398 676
Ford 95VW-3280-AC	Ford 95VW-3280-AD
Ford 95VW-3280-AE	Ford 95VW-3280-AF
Ford 95VW-3280-AG	Ford 95VW-3280-AH
Ford 95VW-3281-AH	Ford YM21-3280-AA
Ford YM21-3280-AB	Ford YM21-3281-AB
Seat 7M0 422 807 G	Seat 7M3 422 803
Seat 7M3 422 803 A	Seat 7M3 422 804
Seat 7M3 422 804 A	Volkswagen 7M0 422 807 G
Volkswagen 7M3 422 803	Volkswagen 7M3 422 803 A
Volkswagen 7M3 422 804	Volkswagen 7M3 422 804 A

**Application info**

Ford Galaxy I (03/95-05/06)      Seat Alhambra I (7V8, 7V9) (03/96-03/10)  
 Volkswagen Sharan (7M) (05/95-03/10)

**Axial rod**

116 030 8275

MAR0059

**Notes**

Front Axle Left  
 Front Axle Right  
 for vehicles with power steering

Length [mm] 308  
 Required quantity 2  
 Thread Size 1 M14x1,5  
 Thread Size 2 M14x1,5  
 replacement in pairs recommended



**References**

Seat 6N0 422 803 A  
Volkswagen 6N0 422 803 A

Seat 6N0 422 804 A  
Volkswagen 6N0 422 804 A

**Application info**

Seat Arosa (6H) (05/97-06/04)

Volkswagen Polo (6N\_) (09/94-10/01)

**Axial rod****116 030 8286****MAR0061****Notes**

Front Axle Left  
Front Axle Right  
for vehicles with power steering

Length [mm] 339  
Manufacturer Restriction ZF  
Required quantity 2  
Thread Size 1 M16x1,5  
Thread Size 2 M14x1,5  
replacement in pairs recommended

**References**

Audi 1J0 422 803  
Audi 1J0 422 804  
Skoda 1J0 422 803 A  
Volkswagen 1J0 422 803 A

Audi 1J0 422 803 A  
Audi 1J0 422 804 A  
Skoda 1J0 422 804 A  
Volkswagen 1J0 422 804 A

**Application info**

Audi A3 I (8L\_) (09/96-09/06)  
Volkswagen Golf IV (1J1, 1J5) (08/97-06/14)

Skoda Octavia I (1U\_) (09/96-12/10)  
Volkswagen New Beetle (1Y7, 9C1, 1C1) (01/98-12/11)

**Axial rod****116 030 8504****MAR0064****Notes**

Front Axle Left  
Front Axle Right  
for vehicles with power steering

Length [mm] 319  
Manufacturer Restriction ZF  
Required quantity 2  
Thread Size 1 M16x1,5  
Thread Size 2 M14x1,5  
replacement in pairs recommended



**References**

Audi 1J0 422 803 B	Audi 1J0 422 804 B
Seat 1J0 422 803 B	Seat 1J0 422 803 E
Seat 1J0 422 804 B	Seat 1J0 422 804 E
Skoda 1J0 422 803 H	Skoda 1J0 422 804 H
Volkswagen 1J0 422 803 E	Volkswagen 1J0 422 803 H
Volkswagen 1J0 422 804 E	Volkswagen 1J0 422 804 H
Volkswagen (FAW) 1J0 422 803 B	Volkswagen (FAW) 1J0 422 803 H
Volkswagen (FAW) 1J0 422 804 B	Volkswagen (FAW) 1J0 422 804 H
Volkswagen (FAW) 1JD 422 803	Volkswagen (FAW) 1JD 422 804
Volkswagen (FAW) L1JD 422 803	Volkswagen (FAW) L1JD 422 804
Volkswagen (SVW) 1JD 422 803	Volkswagen (SVW) 1JD 422 804

**Application info**

Audi A3 I (8L_) (09/96-09/06)	Seat Leon I / Toledo II (1M_) (10/98-06/06)
Skoda Octavia I (1U_) (09/96-12/10)	Volkswagen Bora (1J2, 1J6) (10/98-12/13)
Volkswagen Golf IV (1J1, 1J5) (08/97-06/14)	Volkswagen Jetta City (09/06-12/09)
Volkswagen New Beetle (1Y7, 9C1, 1C1) (01/98-12/11)	

**Axial rod****116 031 0000****MAR0065****Notes**

	Front Axle Left
	Front Axle Right
Length [mm]	310
Required quantity	2
Thread Size 1	M16x1,5
Thread Size 2	M16x1,5
replacement in pairs recommended	

**References**

Audi 1K0 423 810 A	Audi (FAW) 1K0 423 810 A
Seat 1K0 423 810 A	Skoda 1K0 423 810 A
Skoda (SVW) 1K0 423 810 A	Volkswagen 1K0 423 810 A
Volkswagen 1K0 423 821 C	Volkswagen (FAW) 1K0 423 810 A
Volkswagen (SVW) 1K0 423 810 A	

**Application info**

Audi A3 II (8P_) (05/03-12/15)	Audi A3 III (8V_) (04/12--)
Audi Q2 (06/16--)	Audi Q3 I (8U_) (06/11-12/18)
Seat Alhambra II (710) (06/10--)	Seat Leon I / Toledo II (1M_) (10/98-06/06)
Seat Leon II / Toledo III / Altea (1P_ ,5P_) (03/04--)	Seat Leon III (5F_) (09/12--)
Skoda Octavia II (1Z_) (02/04-06/13)	Skoda Octavia III (5E_) (11/12--)
Skoda Superb II (3T) (03/08-05/15)	Skoda Yeti (5L) (05/09-12/17)
Volkswagen CC (11/11-12/16)	Volkswagen Caddy III (2KA, 2KB) (03/04-05/15)
Volkswagen Caddy IV (SA_) (05/15--)	Volkswagen Eos (03/06-08/15)
Volkswagen Golf V (1K1, 1K5, 5M1) (10/03-08/14)	Volkswagen Golf VI (5K1, 517, AJ5) (10/08-05/16)
Volkswagen Golf VII (5G1,BA5) (08/12--)	Volkswagen Jetta III (1K2) (09/04-12/13)
Volkswagen Jetta IV (162) (01/08--)	Volkswagen Jetta VII (BU3) (12/17--)
Volkswagen Passat (362, 365) (08/10-12/15)	Volkswagen Passat (3C_) (03/05-01/12)
Volkswagen Scirocco III (137) (05/08-11/17)	Volkswagen Sharan (7N) (05/10--)
Volkswagen T-Roc (A11) (07/17--)	Volkswagen Tiguan I (5N) (09/07-07/18)
Volkswagen Touran I (1T1/2/3) (02/03-05/15)	

**Axial rod****116 031 0004****MAR0068****Notes**

Front Axle Left  
Front Axle Right

Length [mm]	177
Required quantity	2
Thread Size 1	M16x1,5
Thread Size 2	M16x1,5
replacement in pairs recommended	

**References**

Volkswagen 7E0 419 803	Volkswagen 7E0 419 804
Volkswagen 7H0 419 803 B	Volkswagen 7H0 419 803 C
Volkswagen 7H0 419 803 D	Volkswagen 7H0 419 803 E
Volkswagen 7H0 419 803 F	Volkswagen 7H0 419 804 B
Volkswagen 7H0 419 804 C	Volkswagen 7H0 419 804 D
Volkswagen 7H0 419 804 E	Volkswagen 7H0 419 804 F

**Application info**

Volkswagen Transporter V (04/03-08/15)	Volkswagen Transporter VI (04/15--)
--	-------------------------------------

**Axial rod**

116 031 0005

MAR0069

**Notes**

Front Axle Left  
Front Axle Right

Length [mm] 156  
Required quantity 2  
Thread Size 1 M16x1,5  
Thread Size 2 M14x1,5  
replacement in pairs recommended

**References**

Audi 4F0 422 821

Audi 4F0 422 821 D

Audi (FAW) 4F0 422 821 D

**Application info**

Audi A6 III (4F2, 4FH, 4F5) (04/04-08/11)

**Axial rod**

116 031 0006

MAR0070

**Notes**

Front Axle Left  
Front Axle Right  
for vehicles with power steering

Length [mm] 297  
Manufacturer Restriction TRW  
Required quantity 2  
Thread Size 1 M14x1,5  
Thread Size 2 M14x1,5  
replacement in pairs recommended

**References**

Seat 6Q0 423 803 E

Seat 6Q0 423 803 P

Seat 6Q0 423 804 E

Seat 6Q0 423 804 P

Skoda 6Q0 423 803 E

Skoda 6Q0 423 803 P

Skoda 6Q0 423 804 E

Skoda 6Q0 423 804 P

Skoda (SVW) 6Q0 423 803 P

Skoda (SVW) 6Q0 423 804 P

Volkswagen 6Q0 423 803 E

Volkswagen 6Q0 423 803 P

Volkswagen 6Q0 423 804 E

Volkswagen 6Q0 423 804 P

Volkswagen 6RG 423 810 A

Volkswagen (SVW) 6Q0 423 802 E

Volkswagen (SVW) 6Q0 423 804 E

**Application info**

Seat Ibiza III / Cordoba II (6L\_) (02/02-11/09)  
 Skoda Fabia II (54\_) (12/06-12/14)  
 Volkswagen Fox/Lupo (Z51) (08/03--)  
 Volkswagen Polo Vivo (6S1, 6S3) (02/10-09/17)

Skoda Fabia I (6Y\_) (08/99-03/08)  
 Skoda Roomster (03/06-05/15)  
 Volkswagen Polo (9N\_) (10/01--)

**Axial rod****116 031 0007****MAR0071****Notes**

Front Axle Left  
 Front Axle Right  
 for vehicles without power steering

Length [mm] 318  
 Required quantity 2  
 Thread Size 1 M22x1,5  
 Thread Size 2 M14x1,5  
 replacement in pairs recommended

**References**

Seat 6X0 419 803 A  
 Volkswagen 6X0 419 803 A

Seat 6X0 419 804 A  
 Volkswagen 6X0 419 804 A

**Application info**

Seat Arosa (6H) (05/97-06/04)  
 Volkswagen Polo (6N\_) (09/94-10/01)

Volkswagen Lupo (09/98-07/05)

**Axial rod****116 031 0008****MAR0072****Notes**

Front Axle Left  
 Front Axle Right

Length [mm] 314  
 Required quantity 2  
 Thread Size 1 M14x1,5  
 Thread Size 2 M14x1,5  
 replacement in pairs recommended



**References**

Audi 6R0 423 803 B	Audi 6R0 423 803 C
Audi 6R0 423 803 D	Audi 6R0 423 804 B
Audi 6R0 423 804 C	Audi 6R0 423 804 D
Audi 8Z0 423 803 F	Audi 8Z0 423 804 F
Seat 6R0 423 803	Seat 6R0 423 803 A
Seat 6R0 423 803 C	Seat 6R0 423 804
Seat 6R0 423 804 A	Seat 6R0 423 804 C
Skoda 6R0 423 803 A	Skoda 6R0 423 804 A
Volkswagen 6R0 423 803 A	Volkswagen 6R0 423 803 B
Volkswagen 6R0 423 803 C	Volkswagen 6R0 423 803 D
Volkswagen 6R0 423 804 A	Volkswagen 6R0 423 804 B
Volkswagen 6R0 423 804 C	Volkswagen 6R0 423 804 D

**Application info**

Audi A1 I (8X_) (05/10-10/18)	Audi A2 (8Z0) (02/00-08/05)
Seat Ibiza IV (6J_ ,6P_) (03/08-12/18)	Seat Toledo IV (KG3) (07/12-04/19)
Skoda Rapid II (N_) (07/12-12/19)	Volkswagen Polo (6R_) (03/09--)

**Axial rod****116 031 0009****MAR0073****Notes**

	Front Axle Left
	Front Axle Right
Length [mm]	127
Required quantity	2
Thread Size 1	M16x1,5
Thread Size 2	M16x1,5
replacement in pairs recommended	

**References**

Audi 4E0 419 821	Audi 4E0 419 821 A
Audi (FAW) 4E0 419 821 A	Volkswagen 4E0 419 801 C
Volkswagen 4E0 419 801 D	Volkswagen 4E0 419 801 E

**Application info**

Audi A8 II (4E_) (10/02-12/10)	Volkswagen Phaeton (3D) (04/02-03/16)
--------------------------------	---------------------------------------

**Axial rod**

116 031 0012

MAR0076

**Notes**

Front Axle Left  
 Front Axle Right  
 for vehicles with power steering

Length [mm] 297  
 Manufacturer Restriction TRW  
 Required quantity 2  
 Thread Size 1 M14x1,5  
 Thread Size 2 M14x1,5  
 replacement in pairs recommended

**References**

Skoda 6Q0 423 803 B  
 Volkswagen 6Q0 423 803 B  
 Volkswagen (SVW) 6Q0 423 803 B

Skoda 6Q0 423 804 B  
 Volkswagen 6Q0 423 804 B  
 Volkswagen (SVW) 6Q0 423 804 B

**Application info**

Skoda Fabia I (6Y\_) (08/99-03/08)

Volkswagen Polo (9N\_) (10/01--)

**Axial rod**

116 031 0013

MAR0077

**Notes**

Front Axle Left  
 Front Axle Right

Length [mm] 400  
 Required quantity 2  
 Thread Size 1 M18x1,5  
 Thread Size 2 M16x1,5  
 replacement in pairs recommended

**References**

Mercedes-Benz 906 460 00 55  
 Mercedes-Benz A 906 460 00 55  
 Volkswagen 2E0 713 491

Mercedes-Benz 906 460 01 55  
 Mercedes-Benz A 906 460 01 55

**Application info**

Mercedes-Benz BM 906 (Sprinter II) (06/06--)  
 Volkswagen Crafter I (2E) (04/06-12/16)

Mercedes-Benz BM 907 / 910 (Sprinter III) (02/18--)



**Axial rod****116 031 0014****MAR0375****Notes**Front Axle Left  
Front Axle Right

Length [mm]

330

Required quantity

2

Thread Size 1

M16x1,5

Thread Size 2

M16x1,5

replacement in pairs recommended

**References**

Audi 5Q0 423 810

Seat 561 423 810

Seat 5Q0 423 810

Skoda 561 423 810

Skoda 5Q0 423 810

Volkswagen 561 423 810

Volkswagen 5Q0 423 810

**Application info**

Audi Q3 II (F3\_) (07/18--)

Seat Ateca (04/16--)

Seat Tarraco (09/18--)

Skoda Karoq (07/17--)

Skoda Kodiaq I (10/16--)

Skoda Superb III (3V\_) (03/15--)

Volkswagen Arteon (03/17--)

Volkswagen Beetle (5C1) (04/11-07/19)

Volkswagen Passat (A32) (01/11--)

Volkswagen Passat (B8) (08/14--)

Volkswagen Taos (CL1, CQ1) (10/20--)

Volkswagen Tiguan II (AD1, BW2) (01/16--)

Volkswagen Touran II (5T1) (05/15--)

**Axial rod****116 031 0015****MAR0394****Notes**Front Axle Left  
Front Axle Right

Length [mm]

313

Required quantity

2

Thread Size 1

M14x1,5

Thread Size 2

M14X1,5

replacement in pairs recommended



**References**

Audi 6C0 423 810 B  
 Seat 6C0 423 810 B  
 Skoda 6C0 423 810 A  
 Skoda 6C0 423 810 C  
 Volkswagen 6C0 423 810 B

Audi 6C0 423 810 C  
 Seat 6C0 423 810 C  
 Skoda 6C0 423 810 B  
 Volkswagen 6C0 423 810 A  
 Volkswagen 6C0 423 810 C

**Application info**

Audi A1 I (8X\_) (05/10-10/18)  
 Seat Toledo IV (KG3) (07/12-04/19)  
 Skoda Rapid II (N\_) (07/12-12/19)

Seat Ibiza IV (6J\_ ,6P\_) (03/08-12/18)  
 Skoda Fabia III (NJ\_) (08/14--)  
 Volkswagen Polo (6R\_) (03/09--)

**Axial rod****116 031 0016****MAR0078****Notes**

Front Axle Left  
 Front Axle Right

Length [mm] 288  
 Required quantity 2  
 Thread Size 1 M16x1,5  
 Thread Size 2 M16x1,5  
 replacement in pairs recommended

**References**

Audi 7L0 422 803 C  
 Audi 7L0 422 804 C  
 Porsche 955 347 031 020  
 Porsche 955 347 032 50  
 Volkswagen 2H0 419 804  
 Volkswagen 7L0 422 803 C  
 Volkswagen 7L0 422 804 B  
 Volkswagen 7L0 422 804 D

Audi 7L0 422 803 D  
 Audi 7L0 422 804 D  
 Porsche 955 347 031 021  
 Volkswagen 2H0 419 803  
 Volkswagen 7L0 422 803 B  
 Volkswagen 7L0 422 803 D  
 Volkswagen 7L0 422 804 C

**Application info**

Audi Q7 I (4L\_) (03/06-01/16)  
 Volkswagen Amarok I (09/10--)  
 Volkswagen Touareg II (7P5) (01/10-12/18)

Porsche Cayenne I (955) (09/02-12/10)  
 Volkswagen Touareg I (7LA, 7L6 ,7L7) (10/02-01/13)

## Axial rod

116 031 0017/HD

MAR0492HD

## Notes

Carbon Neutral  
 Front Axle Left  
 Front Axle Right  
 for vehicles with power steering

Length [mm]

297

Manufacturer Restriction

TRW

Required quantity

2

Thread Size 1

M14x1,5

Thread Size 2

M14x1,5

reinforced version

replacement in pairs recommended



## References

Seat 6Q0 423 803 E

Seat 6Q0 423 804 E

Seat 6RG 423 810 A

Skoda 6Q0 423 803 P

Skoda 6Q0 423 804 P

Skoda (SVW) 6Q0 423 803 P

Volkswagen 6Q0 423 803 E

Volkswagen 6Q0 423 804 E

Volkswagen 6RG 423 810 A

Volkswagen (SVW) 6Q0 423 804 E

Seat 6Q0 423 803 P

Seat 6Q0 423 804 P

Skoda 6Q0 423 803 E

Skoda 6Q0 423 804 E

Skoda 6RG 423 810 A

Skoda (SVW) 6Q0 423 804 P

Volkswagen 6Q0 423 803 P

Volkswagen 6Q0 423 804 P

Volkswagen (SVW) 6Q0 423 803 E

## Application info

Seat Ibiza III / Cordoba II (6L\_) (02/02-11/09)

Skoda Fabia II (54\_) (12/06-12/14)

Volkswagen Fox/Lupo (Z51) (08/03--)

Skoda Fabia I (6Y\_) (08/99-03/08)

Skoda Roomster (03/06-05/15)

Volkswagen Polo (9N\_) (10/01--)

## Axial rod

116 031 0019/HD

MAR0494HD

## Notes

Carbon Neutral  
 Front Axle Left  
 Front Axle Right

Length [mm]

400

Required quantity

2

Thread Size 1

M18x1,5

Thread Size 2

M16x1,5

reinforced version

replacement in pairs recommended



**References**

Mercedes-Benz 906 460 00 55  
 Mercedes-Benz A 906 460 00 55  
 Volkswagen 2E0 713 491

Mercedes-Benz 906 460 01 55  
 Mercedes-Benz A 906 460 01 55

**Application info**

Mercedes-Benz BM 906 (Sprinter II) (06/06--)  
 Volkswagen Crafter I (2E) (04/06-12/16)

Mercedes-Benz BM 907 / 910 (Sprinter III) (02/18--)

**Axial rod**

116 031 0020

MAR0079

**Notes**

Front Axle Left  
 Front Axle Right  
 Length [mm] 306  
 Required quantity 2  
 Thread Size 1 M14x1,5  
 Thread Size 2 M14x1,5  
 replacement in pairs recommended



**References**

Seat 1S0 423 810 A  
 Volkswagen 1S0 423 810 A

Skoda 1S0 423 810 A

**Application info**

Seat Mii (10/11--)  
 Volkswagen UP (08/11--)

Skoda Citigo (10/11--)

**Axial rod**

116 031 0021

MAR0080

**Notes**

Front Axle Left  
 Front Axle Right  
 for vehicles without power steering  
 Length [mm] 305  
 Required quantity 2  
 Thread Size 1 M14x1,5  
 Thread Size 2 M14x1,5  
 replacement in pairs recommended



**References**

Skoda 6Q0 419 803 F  
 Volkswagen 6Q0 419 803 F

Skoda 6Q0 419 804 F  
 Volkswagen 6Q0 419 804 F

**Application info**

Skoda Fabia I (6Y\_) (08/99-03/08)

Volkswagen Fox/Lupo (Z51) (08/03--)

Volkswagen Polo (9N\_) (10/01--)

**Axial rod**

116 031 0022

MAR0081

**Notes**

Front Axle Left  
 Front Axle Right  
 for vehicles with power steering

Length [mm] 360

Manufacturer Restriction ZF

Required quantity 2

Thread Size 1 M16x1,5

Thread Size 2 M16x1,5

replacement in pairs recommended

**References**

Audi 8N0 422 803 C

Audi 8N0 422 803 D

Audi 8N0 422 804 C

Audi 8N0 422 804 D

Audi 8N0 422 807 A

Audi 8N0 422 807 C

Seat 8N0 422 803 D

Seat 8N0 422 804 D

Volkswagen 8N0 422 803 C

Volkswagen 8N0 422 803 D

Volkswagen 8N0 422 804 C

Volkswagen 8N0 422 804 D

**Application info**

Audi A3 I (8L\_) (09/96-09/06)

Audi TT I (8N\_) (10/98-12/06)

Seat Leon I / Toledo II (1M\_) (10/98-06/06)

Volkswagen Golf IV (1J1, 1J5) (08/97-06/14)

Volkswagen New Beetle (1Y7, 9C1, 1C1) (01/98-12/11)

**Axial rod**

116 031 0023

MAR0082

**Notes**

Front Axle Left  
 Front Axle Right

Length [mm] 226

Required quantity 2

Thread Size 1 M16x1,5

Thread Size 2 M16x1,5

replacement in pairs recommended



**References**

Audi 4H0 422 810  
 Audi 8J0 423 810  
 Audi (FAW) 8J0 423 810

Audi 4H0 422 810 A  
 Audi (FAW) 4H0 422 810 A

**Application info**

Audi A4 IV (8K\_) (08/07-05/16)  
 Audi A8 III (4H\_) (11/09-01/18)  
 Audi TT II (8J\_) (07/06-01/15)

Audi A5 I (8F\_ , 8T\_) (06/07-01/17)  
 Audi Q5 I (8R\_) (11/08-12/17)

**Axial rod****116 031 0024****MAR0083****Notes**

Front Axle Left  
 Front Axle Right

Length [mm] 159  
 Required quantity 2  
 Thread Size 1 M16x1,5  
 Thread Size 2 M16x1,5  
 replacement in pairs recommended

**References**

Mercedes-Benz 163 338 02 15  
 Mercedes-Benz A 163 338 02 15

Mercedes-Benz 163 460 00 05  
 Mercedes-Benz A 163 460 00 05

**Application info**

Mercedes-Benz BM 163 (M-Class) (02/98-07/05)

**Axial rod****116 031 0027****MAR0084****Notes**

Front Axle Left  
 Front Axle Right  
 for vehicles with power steering

Length [mm] 317  
 Required quantity 2  
 Thread Size 1 M14x1,5  
 Thread Size 2 M14X1,5  
 replacement in pairs recommended

**References**

Volkswagen 155 422 803  
 Volkswagen 175 422 803

Volkswagen 155 422 803 A

**Application info**

Volkswagen Golf I (17, 155) (04/74-08/93)

Volkswagen Scirocco II (53B) (08/80-07/92)

Volkswagen Jetta I (16) (08/78-12/87)

**Axial rod**

116 031 0028

MAR0085

**Notes**Front Axle Left  
Front Axle Right

Length [mm]

236

Required quantity

2

Thread Size 1

M16x1,5

Thread Size 2

M16x1,5

replacement in pairs recommended

**References**

Audi 4G0 423 810

Audi (FAW) 4G0 423 810 A

Porsche 4G0 423 810 A

Audi 4G0 423 810 A

Porsche 4G0 423 810

Volkswagen (SVW) 4G0 423 810 A

**Application info**

Audi A6 IV (4G2, 4G5, C7) (11/10-09/18)

Audi A8 III (4H\_) (11/09-01/18)

Porsche Macan (95B) (02/14--)

Audi A7 I Sportback (4G\_) (07/10-05/18)

Audi Q5 I (8R\_) (11/08-12/17)

**Axial rod**

116 031 0029/HD

MAR0495HD

**Notes**Carbon Neutral  
Front Axle Left  
Front Axle Right

Length [mm]

314

Required quantity

2

Thread Size 1

M14x1,5

Thread Size 2

M14x1,5

reinforced version

replacement in pairs recommended



**References**

Audi 6R0 423 803 B	Audi 6R0 423 803 C
Audi 6R0 423 803 D	Audi 6R0 423 804 B
Audi 6R0 423 804 C	Audi 6R0 423 804 D
Audi 8Z0 423 803 F	Audi 8Z0 423 804 F
Seat 6R0 423 803	Seat 6R0 423 803 A
Seat 6R0 423 803 C	Seat 6R0 423 804
Seat 6R0 423 804 A	Seat 6R0 423 804 C
Skoda 6R0 423 803 A	Skoda 6R0 423 804 A
Volkswagen 6R0 423 803 A	Volkswagen 6R0 423 803 B
Volkswagen 6R0 423 803 C	Volkswagen 6R0 423 803 D
Volkswagen 6R0 423 804 A	Volkswagen 6R0 423 804 B
Volkswagen 6R0 423 804 C	Volkswagen 6R0 423 804 D

**Application info**

Audi A1 I (8X_) (05/10-10/18)	Audi A2 (8Z0) (02/00-08/05)
Seat Ibiza IV (6J_ ,6P_) (03/08-12/18)	Seat Toledo IV (KG3) (07/12-04/19)
Skoda Rapid II (N_) (07/12-12/19)	Volkswagen Polo (6R_) (03/09--)

**Axial rod****116 031 0030****MAR0553****Notes**

	Front Axle Left
	Front Axle Right
Length [mm]	217
Required quantity	2
Thread Size 1	M16x1,5
Thread Size 2	M16x1,5
replacement in pairs recommended	

**References**

Audi 8W0 423 810	Audi 8W0 423 810 A
Audi (FAW) 8W0 423 810	

**Application info**

Audi A4 V (8W_) (05/15--)	Audi A5 II (F5_) (06/16--)
---------------------------	----------------------------





## Axial rod

116 031 0033/HD

MAR0572HD

## Notes

Carbon Neutral  
Front Axle Left  
Front Axle Right

Length [mm]

310

Required quantity

2

Thread Size 1

M14x1,5

Thread Size 2

M16x1,5

reinforced version

replacement in pairs recommended



## References

Audi 2Q0 423 810 D

Seat 2Q0 423 810 D

Skoda 2Q0 423 810 D

Volkswagen 2Q0 423 810 D

## Application info

Audi A1 II (GB\_) (07/18--)

Seat Arona (KJ7) (07/17--)

Seat Ibiza V (KJ1) (01/17--)

Skoda Fabia IV (PJ3) (06/21--)

Skoda Kamiq (07/19--)

Skoda Scala (02/19--)

Volkswagen Nivus / Taigo (11/21--)

Volkswagen Polo (AW1) (06/17--)

Volkswagen T-Cross (12/18--)

## Axial rod

116 031 0034

MAR0599

## Notes

Front Axle Left  
Front Axle Right

Length [mm]

212

Required quantity

2

Thread Size 1

M16x1,5

Thread Size 2

M16x1,5

replacement in pairs recommended



## References

Audi 8S0 423 810 A

Audi 8S0 423 810 B

## Application info

Audi TT III (8S\_) (07/14--)

**Axial rod**

116 031 0035

MAR0642

**Notes**

Front Axle Left  
Front Axle Right

Length [mm] 269  
Required quantity 2  
Thread Size 1 M16x1,5  
Thread Size 2 M14x1,5  
replacement in pairs recommended

**References**

Audi 420 422 821 A

**Application info**

Audi R8 I (42\_) (04/07-07/15)

**Axial rod**

116 031 0036

MAR0661

**Notes**

Front Axle Left  
Front Axle Right

Length [mm] 413  
Required quantity 2  
Thread Size 1 M16x1,5  
Thread Size 2 M16x1,5  
replacement in pairs recommended

**References**

Audi 1EA 423 810 C

Skoda 1EA 423 810 C

Volkswagen 1EA 423 810 C

**Application info**



Audi Q4 (F4\_) (03/21--)

Skoda Enyaq iV (5A\_) (10/20--)

Volkswagen ID.4 (E21) (05/20--)

Volkswagen ID.5 (E39) (07/21--)

Volkswagen ID.7 (06/23--)

Axial rod		116 031 0037	MAR0663
<b>Notes</b>  Front Axle Left Front Axle Right  Length [mm] 392 Required quantity 2 Thread Size 1 M16x1,5 Thread Size 2 M16x1,5 replacement in pairs recommended			
<b>References</b> CUPRA 1EA 423 810 B		Volkswagen 1EA 423 810 B	
<b>Application info</b> CUPRA BORN (K11) (08/21-- )		Volkswagen ID.3 (E11_) (11/19-- )	
Axial rod		116 031 0038	MAR0659
<b>Notes</b>  Front Axle Left Front Axle Right  Length [mm] 305 Required quantity 2 Thread Size 1 M16x1,5 Thread Size 2 M16x1,5 replacement in pairs recommended			
<b>References</b> Audi 5WA 423 810 C Seat 5WA 423 810 C Volkswagen 5WA 423 810 C		CUPRA 5WA 423 810 C Skoda 5WA 423 810 C	
<b>Application info</b> Audi A3 IV (8Y_) (11/19-- ) Seat Leon IV (KL_) (11/19-- ) Volkswagen Golf VIII (CB1) (07/19-- )		Audi Q2 (06/16-- ) Skoda Octavia IV (NX_) (11/19-- ) Volkswagen T-Roc (A11) (07/17-- )	

**Axial rod**

116 031 0039

MAR0662

**Notes**

Front Axle Left  
Front Axle Right

Length [mm] 327  
Required quantity 2  
Thread Size 1 M16x1,5  
Thread Size 2 M16x1,5  
replacement in pairs recommended

**References**

Audi 5WA 423 810 F  
Skoda 5WA 423 810 F

Seat 5WA 423 810 F  
Volkswagen 5WA 423 810 F

**Application info**

Audi Q3 II (F3\_) (07/18--)  
Skoda Kodiaq I (10/16--)  
Volkswagen Tiguan III (CT1) (09/23--)

Seat Tarraco (09/18--)  
Volkswagen Tiguan II (AD1, BW2) (01/16--)

**Axial rod**

116 031 0040

MAR0660

**Notes**

Front Axle Left  
Front Axle Right

Length [mm] 329  
Required quantity 2  
Thread Size 1 M16x1,5  
Thread Size 2 M16x1,5  
replacement in pairs recommended

**References**

CUPRA 5WA 423 810 D  
Ford VWN3CA3280AA  
Skoda 5WA 423 810 D

Ford 2 560 580  
Seat 5WA 423 810 D  
Volkswagen 5WA 423 810 D

**Application info**

CUPRA ATECA (KH7\_KHP) (09/18--)  
Seat Ateca (04/16--)  
Volkswagen Caddy V (SBB, SBJ) (09/20--)  
Volkswagen Taos (CL1, CQ1) (10/20--)

CUPRA FORMENTOR (KM\_) (07/20--)  
Volkswagen Arteon (03/17--)  
Volkswagen Passat (B8) (08/14--)



**Drag link**

016 040 0001

MDL0001

**Notes**Centre  
Guide Rod

Length [mm]

1336

Required quantity

1

Thread Size 1

M12x1,5

Thread Size 2

M12x1,5

**References**

Mercedes-Benz 202 460 05 05

Mercedes-Benz A 202 460 05 05

**Application info**

Mercedes-Benz BM 202 (C-Class) (03/93-03/01)

Mercedes-Benz BM 208 (CLK) (06/97-12/03)

**Drag link**

016 040 0129

MDL0002

**Notes**Centre  
Guide Rod

Length [mm]

520

Required quantity

1

Thread Size 1

M12x1,5

Thread Size 2

M12x1,5

**References**

Mercedes-Benz 129 460 04 05

Mercedes-Benz A 129 460 04 05

**Application info**

Mercedes-Benz BM 129 (SL) (03/89-09/04)

**Drag link**

016 040 3100

MDL0003

**Notes**Centre  
Push Rod

Length [mm]

490

Required quantity

1

Thread Size 1

M10x1

Thread Size 2

M10x1

**References**

Mercedes-Benz 201 460 14 05

Mercedes-Benz 201 460 15 05

Mercedes-Benz A 201 460 14 05

Mercedes-Benz A 201 460 15 05

**Application info**

Mercedes-Benz BM 201 ( 190) (10/82-08/93)

**Drag link**

016 040 6059

MDL0004

**Notes**Centre  
Guide Rod

Length [mm]

472

Required quantity

1

Thread Size 1

M10x1

Thread Size 2

M10x1

**References**

Mercedes-Benz 107 460 05 05

Mercedes-Benz 107 460 06 05



Mercedes-Benz A 107 460 05 05

Mercedes-Benz A 107 460 06 05

**Application info**

Mercedes-Benz BM 107 (SL) (05/71-12/89)



Drag link		016 040 6066	MDL0008
<b>Notes</b>  Centre Guide Rod for left-hand drive vehicles  Length [mm] 477 Required quantity 1 Thread Size 1 M10x1 Thread Size 2 M10x1			
<b>References</b> Mercedes-Benz 126 460 06 05 Mercedes-Benz 126 460 08 05 Mercedes-Benz A 126 460 06 05 Mercedes-Benz A 126 460 08 05			
<b>Application info</b> Mercedes-Benz BM 126 (S-Class) (10/79-06/91)			
Drag link		016 040 6329	MDL0014
<b>Notes</b>  Centre Guide Rod  Length [mm] 1300 Required quantity 1 Thread Size 1 2x M12x1,5 Thread Size 2 2x M12x1,5			
<b>References</b> Mercedes-Benz 202 460 04 05 Mercedes-Benz A 202 460 04 05			
<b>Application info</b> Mercedes-Benz BM 202 (C-Class) (03/93-03/01) Mercedes-Benz BM 208 (CLK) (06/97-12/03)			

**Drag link**

036 030 0013

MDL0021

**Notes**Centre  
Guide Rod

Cone Size [mm]

21

Length [mm]

640

Pipe Diameter [mm]

30

Required quantity

1

Thread Size 1

M18x1,5

Thread Size 2

M18x1,5

**References**

Mercedes-Benz 631 330 05 35

Mercedes-Benz 631 330 06 03

Mercedes-Benz A 631 330 05 35

Mercedes-Benz A 631 330 06 03

**Application info**

Mercedes-Benz BM 631 (02/88-04/96)

**Repair kit, tie rod axial rod**

116 031 0013/S

MSX0073

**Notes**Front Axle Left  
Front Axle Right

Required quantity

2

**References**

Mercedes-Benz 906 460 00 55

Mercedes-Benz A 906 460 00 55

Volkswagen 2E0 713 491

**Application info**

Mercedes-Benz BM 906 (Sprinter II) (06/06--)

Volkswagen Crafter I (2E) (04/06-12/16)

**Tie rod assembly****016 030 6320****MTA0010****Notes**

Front Axle Left  
Front Axle Right

Required quantity

2

Thread Size 1

M12x1,5

Thread Size 2

M12x1,5

replacement in pairs recommended

**References**

Mercedes-Benz 140 330 00 03

Mercedes-Benz 140 330 01 03

Mercedes-Benz A 140 330 00 03

Mercedes-Benz A 140 330 01 03

**Application info**

Mercedes-Benz BM 140 (S-Class) (02/91-12/99)

**Tie rod assembly****036 030 0033****MTA0018****Notes**

Front Axle Left  
Front Axle Right

Required quantity

2

Thread Size 1

M16x1,5

Thread Size 2

M16x1,5

replacement in pairs recommended

**References**

Mercedes-Benz 901 460 02 05

Mercedes-Benz A 901 460 02 05

Volkswagen 2D0 422 803

**Application info**

Mercedes-Benz BM 901 / 902 (Sprinter I) (01/95-05/06)

Mercedes-Benz BM 903 (Sprinter I) (01/95-05/12)

Mercedes-Benz BM 904 (Sprinter I) (02/95-05/12)

Mercedes-Benz BM 909 (Sprinter) (09/13--)

Volkswagen LT II (04/96-07/06)

**Tie rod assembly****036 040 0019****MTA0024****Notes**

	Front Axle Left
	Front Axle Right
Required quantity	2
Thread Size 1	M14x1,5
Thread Size 2	M16x1,5
replacement in pairs recommended	

**References**

Mercedes-Benz 638 460 02 05

Mercedes-Benz A 638 460 02 05

**Application info**

Mercedes-Benz BM 638 (V-Class / Vito) (02/96-07/03)

**Tie rod assembly****116 030 0003****MTA0029****Notes**

	Front Axle Right
	for vehicles with power steering
Manufacturer Restriction	ZF
Paired article number	116 030 0004   MTA0030
Required quantity	1
Thread Size 1	M12x1,5
Thread Size 2	M16x1,5
replacement in pairs recommended	

**References**

Audi 8N0 422 804 A

Audi 8N0 422 804 D

Seat 8N0 422 804 D

Volkswagen 8N0 422 804 C

Volkswagen 8N0 422 804 D

**Application info**

Audi A3 I (8L\_) (09/96-09/06)



Audi TT I (8N\_) (10/98-12/06)

Seat Leon I / Toledo II (1M\_) (10/98-06/06)

Volkswagen Golf IV (1J1, 1J5) (08/97-06/14)

Volkswagen New Beetle (1Y7, 9C1, 1C1) (01/98-12/11)



Tie rod assembly		116 030 0010	MTA0032
<b>Notes</b>  Front Axle Left for vehicles with power steering  Manufacturer Restriction TRW Paired article number 116 030 0011   MTA0033 Required quantity 1 Thread Size 1 M12x1,5 Thread Size 2 M14x1,5 replacement in pairs recommended			
<b>References</b> Skoda 6Q0 423 803 B Volkswagen 6Q0 423 803 B Volkswagen (SVW) 6Q0 423 803 B			
<b>Application info</b> Skoda Fabia I (6Y_) (08/99-03/08) Volkswagen Polo (9N_) (10/01-- )			
Tie rod assembly		116 030 0011	MTA0033
<b>Notes</b>  Front Axle Right for vehicles with power steering  Manufacturer Restriction TRW Paired article number 116 030 0010   MTA0032 Required quantity 1 Thread Size 1 M12x1,5 Thread Size 2 M14x1,5 replacement in pairs recommended			
<b>References</b> Skoda 6Q0 423 804 B Volkswagen 6Q0 423 804 B Volkswagen (SVW) 6Q0 423 804 B			
<b>Application info</b> Skoda Fabia I (6Y_) (08/99-03/08) Volkswagen Polo (9N_) (10/01-- )			

## Tie rod assembly

116 030 0013

MTA0034

## Notes

Front Axle Left

Paired article number 116 030 0014 | MTA0035

Required quantity 1

Thread Size 1 M14x1,5

Thread Size 2 M16x1,5

replacement in pairs recommended



## References

Audi 7L0 422 803 D

Porsche 955 347 031 21

Volkswagen 2H0 419 804

Volkswagen 7L0 422 803 C

Porsche 955 347 031 20

Porsche 955 347 031 22

Volkswagen 7L0 422 803 B

Volkswagen 7L0 422 803 D

## Application info

Audi Q7 I (4L\_) (03/06-01/16)

Porsche Cayenne II (92A) (06/10--)

Volkswagen Amarok II (T1\_) (09/22--)

Volkswagen Touareg II (7P5) (01/10-12/18)

Porsche Cayenne I (955) (09/02-12/10)

Volkswagen Amarok I (09/10--)

Volkswagen Touareg I (7LA, 7L6, 7L7) (10/02-01/13)

## Tie rod assembly

116 030 0014

MTA0035

## Notes

Front Axle Right

Paired article number 116 030 0013 | MTA0034

Required quantity 1

Thread Size 1 M14x1,5

Thread Size 2 M16x1,5

replacement in pairs recommended



## References

Audi 7L0 422 804 D

Porsche 955 347 032 21

Volkswagen 2H0 419 803

Volkswagen 7L0 422 804 C

Porsche 955 347 032 20

Porsche 955 347 032 22

Volkswagen 7L0 422 804 B

Volkswagen 7L0 422 804 D

**Application info**

Audi Q7 I (4L\_) (03/06-01/16)

Porsche Cayenne II (92A) (06/10--)

Volkswagen Touareg I (7LA, 7L6, 7L7) (10/02-01/13)

Porsche Cayenne I (955) (09/02-12/10)

Volkswagen Amarok I (09/10--)

Volkswagen Touareg II (7P5) (01/10-12/18)

**Tie rod assembly****116 030 0015****MTA0036****Notes**

Front Axle Left

Paired article number 116 030 0016 | MTA0037

Required quantity 1

Thread Size 1 M14x1,5

Thread Size 2 M16x1,5

replacement in pairs recommended

**References**

Volkswagen 7E0 419 803

Volkswagen 7H0 419 803 C

Volkswagen 7H0 419 803 E

Volkswagen 7H0 422 807 A

Volkswagen 7H0 419 803 B

Volkswagen 7H0 419 803 D

Volkswagen 7H0 419 803 F

**Application info**

Volkswagen Transporter V (04/03-08/15)

Volkswagen Transporter VI (04/15--)

**Tie rod assembly****116 030 0016****MTA0037****Notes**

Front Axle Right

Paired article number 116 030 0015 | MTA0036

Required quantity 1

Thread Size 1 M14x1,5

Thread Size 2 M15x1,5

replacement in pairs recommended

**References**

Volkswagen 7E0 419 804

Volkswagen 7H0 419 804 C

Volkswagen 7H0 419 804 E

Volkswagen 7H0 422 807 A

Volkswagen 7H0 419 804 B

Volkswagen 7H0 419 804 D

Volkswagen 7H0 419 804 F



**Application info**

Volkswagen Transporter V (04/03-08/15)

Volkswagen Transporter VI (04/15--)

**Tie rod assembly****116 030 0018****MTA0038****Notes**

Front Axle Left

Paired article number 116 030 0019 | MTA0039

Required quantity 1

Thread Size 1 M12x1,5

Thread Size 2 M16x1,5

replacement in pairs recommended

**References**

Audi 1K0 423 810 A

Audi 1K0 423 811 J

Seat 1K0 423 810 A

Seat 1K0 423 811 J

Skoda 1K0 423 803 C

Skoda (SVW) 1K0 423 810 A

Volkswagen 1K0 423 810 A

Volkswagen 1K0 423 811 K

Volkswagen (FAW) 1K0 423 811 E

Volkswagen (SVW) 1K0 423 810 A

Audi 1K0 423 811 G

Audi (FAW) 1K0 423 811 G

Seat 1K0 423 811 G

Seat 1K0 423 811 K

Skoda 1K0 423 811 G

Volkswagen 1K0 423 803 C

Volkswagen 1K0 423 811 G

Volkswagen (FAW) 1K0 423 810 A

Volkswagen (FAW) 1K0 423 811 G

Volkswagen (SVW) 1K0 423 811 G

**Application info**

Audi A3 II (8P\_) (05/03-12/15)

Audi A3 IV (8Y\_) (11/19--)

Audi Q3 I (8U\_) (06/11-12/18)

Seat Leon II / Toledo III / Altea (1P\_ ,5P\_) (03/04--)

Skoda Octavia IV (NX\_) (11/19--)

Skoda Yeti (5L) (05/09-12/17)

Volkswagen Caddy III (2KA, 2KB) (03/04-05/15)

Volkswagen Eos (03/06-08/15)

Volkswagen Golf VI (5K1, 517, AJ5) (10/08-05/16)

Volkswagen Golf VIII (CB1) (07/19--)

Volkswagen Jetta IV (162) (01/08--)

Volkswagen Passat (3C\_) (03/05-01/12)

Volkswagen Sharan (7N) (05/10--)

Volkswagen Touran I ( 1T1/2/3) (02/03-05/15)

Audi A3 III (8V\_) (04/12--)

Audi Q2 (06/16--)

Seat Alhambra II (710) (06/10--)

Skoda Octavia II (1Z\_) (02/04-06/13)

Skoda Superb II (3T) (03/08-05/15)

Volkswagen CC (11/11-12/16)

Volkswagen Caddy IV (SA\_) (05/15--)

Volkswagen Golf V (1K1, 1K5, 5M1) (10/03-08/14)

Volkswagen Golf VII (5G1,BA5) (08/12--)

Volkswagen Jetta III (1K2) (09/04-12/13)

Volkswagen Passat (362, 365) (08/10-12/15)

Volkswagen Scirocco III (137) (05/08-11/17)

Volkswagen Tiguan I (5N ) (09/07-07/18)

## Tie rod assembly

116 030 0019

MTA0039

## Notes

Front Axle Right

Paired article number 116 030 0018 | MTA0038

Required quantity 1

Thread Size 1 M12x1,5

Thread Size 2 M16x1,5

replacement in pairs recommended



## References

Audi 1K0 423 810 A

Audi 1K0 423 812 J

Seat 1K0 423 812 G

Seat 1K0 423 812 K

Skoda 1K0 423 804 C

Skoda (SVW) 1K0 423 810 A

Volkswagen 1K0 423 810 A

Volkswagen 1K0 423 812 K

Volkswagen (FAW) 1K0 423 812 G

Volkswagen (SVW) 1K0 423 812 G

Audi 1K0 423 812 G

Audi (FAW) 1K0 423 812 G

Seat 1K0 423 812 J

Seat 1K0 823 810 A

Skoda 1K0 423 812 G

Volkswagen 1K0 423 804 C

Volkswagen 1K0 423 812 G

Volkswagen (FAW) 1K0 423 810 A

Volkswagen (SVW) 1K0 423 810 A

## Application info

Audi A3 II (8P\_) (05/03-12/15)

Audi A3 IV (8Y\_) (11/19--)

Audi Q3 I (8U\_) (06/11-12/18)

Seat Leon II / Toledo III / Altea (1P\_ ,5P\_) (03/04--)

Skoda Octavia IV (NX\_) (11/19--)

Skoda Yeti (5L) (05/09-12/17)

Volkswagen Caddy III (2KA, 2KB) (03/04-05/15)

Volkswagen Eos (03/06-08/15)

Volkswagen Golf VI (5K1, 517, AJ5) (10/08-05/16)

Volkswagen Golf VIII (CB1) (07/19--)

Volkswagen Jetta IV (162) (01/08--)

Volkswagen Passat (3C\_) (03/05-01/12)

Volkswagen Sharan (7N) (05/10--)

Volkswagen Touran I (1T1/2/3) (02/03-05/15)

Audi A3 III (8V\_) (04/12--)

Audi Q2 (06/16--)

Seat Alhambra II (710) (06/10--)

Skoda Octavia II (1Z\_) (02/04-06/13)

Skoda Superb II (3T) (03/08-05/15)

Volkswagen CC (11/11-12/16)

Volkswagen Caddy IV (SA\_) (05/15--)

Volkswagen Golf V (1K1, 1K5, 5M1) (10/03-08/14)

Volkswagen Golf VII (5G1,BA5) (08/12--)

Volkswagen Jetta III (1K2) (09/04-12/13)

Volkswagen Passat (362, 365) (08/10-12/15)

Volkswagen Scirocco III (137) (05/08-11/17)

Volkswagen Tiguan I (5N ) (09/07-07/18)

## Tie rod assembly

116 030 0020/HD

MTA0040HD

## Notes

Carbon Neutral  
Front Axle Left  
Front Axle Right

Required quantity 2  
Thread Size 1 M8x1,25  
Thread Size 2 M16x1,5  
reinforced version  
replacement in pairs recommended



## References

Audi 4B0 419 801 G  
Audi 8E0 422 821 C  
Audi (FAW) 4F0 498 811 A  
Audi (FAW) 8E0 422 821  
Volkswagen (SVW) 4F0 419 811 C

Audi 8E0 419 801 E  
Audi (FAW) 4D0 422 821 A  
Audi (FAW) 8E0 419 801 E  
Seat 8E0 422 821 C  
Volkswagen (SVW) 8E0 419 811

## Application info

Audi A4 Cabriolet (8H\_) (01/02-12/09)  
Audi A4 III (8E\_) (11/04-06/08)  
Seat Exeo (3R) (12/08-05/13)

Audi A4 II (8E\_) (02/00-12/05)  
Audi A6 II (4B, C5) (01/97-12/05)

## Tie rod assembly

116 030 0022

MTA0041

## Notes

Front Axle Left  
for vehicles without power steering

Paired article number 116 030 0023 | MTA0042  
Required quantity 1  
Thread Size 1 M12x1,5  
Thread Size 2 M14x1,5  
replacement in pairs recommended



## References

Skoda 6Q0 419 803 B  
Skoda 6Q0 419 803 F  
Volkswagen 6Q0 419 803 D

Skoda 6Q0 419 803 D  
Volkswagen 6Q0 419 803 B  
Volkswagen 6Q0 419 803 F

## Application info

Skoda Fabia I (6Y\_) (08/99-03/08)  
Volkswagen Polo (9N\_) (10/01--)

Volkswagen Fox/Lupo (Z51) (08/03--)

**Tie rod assembly****116 030 0023****MTA0042****Notes**

	Front Axle Right for vehicles without power steering
Paired article number	116 030 0022   MTA0041
Required quantity	1
Thread Size 1	M12x1,5
Thread Size 2	M14x1,5
replacement in pairs recommended	

**References**

Skoda 6Q0 419 804 B	Skoda 6Q0 419 804 D
Skoda 6Q0 419 804 F	Volkswagen 6Q0 419 804 B
Volkswagen 6Q0 419 804 D	Volkswagen 6Q0 419 804 F

**Application info**

Skoda Fabia I (6Y_) (08/99-03/08)	Volkswagen Fox/Lupo (Z51) (08/03--)
Volkswagen Polo (9N_) (10/01--)	

**Tie rod assembly****116 030 0028/HD****MTA0043HD****Notes**

	Carbon Neutral Front Axle Left Front Axle Right
Required quantity	2
Thread Size 1	M8x1,25
Thread Size 2	M16x1,5
reinforced version replacement in pairs recommended	

**References**

Audi 4F0 419 811 D	Audi 4F0 498 811 A
Audi 4F0 498 811 C	Audi (FAW) 4F0 419 811 D
Audi (FAW) 4F0 422 821 D	Audi (FAW) 4F0 498 811 A
Seat 4B0 419 811 G	Seat 4D0 419 811 J
Seat 4F0 498 811 A	Seat 4F0 498 811 C
Seat 8E0 419 811	

**Application info**

Audi A6 III (4F2, 4FH, 4F5) (04/04-08/11)
---

**Tie rod assembly** **116 030 0033** **MTA0048**

**Notes**

Front Axle Left  
Front Axle Right

Required quantity 2  
Thread Size 1 M14x1,5  
Thread Size 2 M18x1,5  
replacement in pairs recommended



**References**

- |                               |                               |
|-------------------------------|-------------------------------|
| Mercedes-Benz 906 460 00 48   | Mercedes-Benz 906 460 00 55   |
| Mercedes-Benz 906 460 01 48   | Mercedes-Benz A 906 460 00 48 |
| Mercedes-Benz A 906 460 00 55 | Mercedes-Benz A 906 460 01 48 |
| Volkswagen 2E0 498 104        | Volkswagen 2E0 713 201        |
| Volkswagen 2E0 713 491        |                               |

**Application info**

Mercedes-Benz BM 906 (Sprinter II) (06/06--)  
Volkswagen Crafter I (2E) (04/06-12/16)

**Tie rod assembly** **116 030 0042/HD** **MTA0287HD**

**Notes**

Front Axle Right  
Manufacturer Restriction TRW  
Paired article number 116 030 0039/HD | MTA0285HD  
Required quantity 1  
Thread Size 1 M12x1,5  
Thread Size 2 M14x1,5

reinforced version  
replacement in pairs recommended



**References**

Audi 6Q0 423 812 C  
 Audi 6R0 423 804  
 Audi 6R0 423 804 C  
 Audi 6RD 423 812 B  
 Seat 6Q0 423 831 D  
 Seat 6R0 423 804 A  
 Seat 6R0 423 804 D  
 Skoda 6Q0 423 812 C  
 Skoda 6R0 423 804  
 Skoda 6R0 423 804 C  
 Skoda 6RD 423 812 B

Audi 6Q0 423 831 D  
 Audi 6R0 423 804 A  
 Audi 6R0 423 804 D  
 Seat 6Q0 423 812 C  
 Seat 6R0 423 804  
 Seat 6R0 423 804 C  
 Seat 6RD 423 812 B  
 Skoda 6Q0 423 831 D  
 Skoda 6R0 423 804 A  
 Skoda 6R0 423 804 D

**Application info**

Audi A1 I (8X\_) (05/10-10/18)  
 Seat Toledo IV (KG3) (07/12-04/19)

Seat Ibiza IV (6J\_ ,6P\_) (03/08-12/18)  
 Skoda Rapid II (N\_) (07/12-12/19)

**Tie rod assembly****116 030 0652****MTA0054****Notes**

Front Axle Left

Paired article number 116 040 0653 | MTA0125  
 Required quantity 1  
 Thread Size 1 M12x1,5  
 Thread Size 2 M12x1,5  
 replacement in pairs recommended



**References**



Volkswagen 211 415 801 E

Volkswagen 211 415 801 F

**Application info**

Volkswagen Transporter II (08/67-09/79)

Tie rod assembly		116 030 3250	MTA0059
<p><b>Notes</b></p> <p>Front Axle Left Front Axle Right for vehicles without power steering</p> <p>Required quantity 2 Thread Size 1 M12x1,5 replacement in pairs recommended</p>			
<p><b>References</b></p> <p>Volkswagen 133 419 804 A Volkswagen 133 419 804 B</p>			
<p><b>Application info</b></p> <p>Volkswagen Käfer / Karmann Ghia (12/47-08/03)</p>			
Tie rod assembly		116 030 3266	MTA0060
<p><b>Notes</b></p> <p>Front Axle Left Front Axle Right</p> <p>Required quantity 2 Thread Size 1 M12x1,5 Thread Size 2 M14x1,5 replacement in pairs recommended</p>			
<p><b>References</b></p> <p>Volkswagen 251 419 803 Volkswagen 251 419 803 A</p>			
<p><b>Application info</b></p> <p>Volkswagen Transporter III (05/79-12/02)</p>			

Tie rod assembly		116 030 7133	MTA0064
<b>Notes</b>  Front Axle Left Front Axle Right for vehicles with power steering  Required quantity 2 Thread Size 1 M12x1,5 Thread Size 2 M14x1,5 replacement in pairs recommended			
<b>References</b> Volkswagen 155 422 803 Volkswagen 155 422 803 A Volkswagen 175 422 803			
<b>Application info</b> Volkswagen Golf I (17, 155) (04/74-08/93) Volkswagen Jetta I (16) (08/78-12/87) Volkswagen Scirocco II (53B) (08/80-07/92)			
Tie rod assembly		116 030 8202	MTA0077
<b>Notes</b>  Front Axle Left for vehicles with power steering  Manufacturer Restriction TRW Paired article number 116 030 8203   MTA0078 Required quantity 1 Thread Size 1 M12x1,5 Thread Size 2 M14x1,5 replacement in pairs recommended			
<b>References</b> Seat 1H0 422 803 Seat 1H0 422 803 A Volkswagen 1H0 422 803 Volkswagen 1H0 422 803 A			
<b>Application info</b> Seat Toledo I (1L_) (01/91-10/99) Volkswagen Corrado (53I) (08/87-12/95) Volkswagen Golf III (1H1, 1H5, 1E7) (10/89-12/02) Volkswagen Vento (11/91-09/98)			





## Tie rod assembly

116 030 8205

MTA0080

## Notes

Front Axle Right  
for vehicles with power steering

Manufacturer Restriction

ZF

Paired article number

116 030 8204 | MTA0079

Required quantity

1

Thread Size 1

M12x1,5

Thread Size 2

M14x1,5

replacement in pairs recommended



## References

Volkswagen 1H0 422 804 B

Volkswagen 1H0 422 804 C

## Application info

Volkswagen Corrado (53I) (08/87-12/95)

Volkswagen Golf III (1H1, 1H5, 1E7) (10/89-12/02)

Volkswagen Vento (11/91-09/98)

## Tie rod assembly

116 030 8227/HD

MTA0084HD

## Notes

Carbon Neutral  
Front Axle Left  
Front Axle Right

Required quantity

2

Thread Size 1

M8x1,25

Thread Size 2

M16x1,5

reinforced version

replacement in pairs recommended



## References

Audi 4B0 419 801 B

Audi 4B0 419 801 M

Audi 4D0 419 801 B

Audi 4D0 419 801 E

Audi 4D0 419 801 L

Audi 8E0 419 801 B

Audi (FAW) 4B0 419 801 M

Audi (FAW) 4D0 422 821 A

Skoda 4B0 419 801 B

Skoda 4B0 419 801 M

Skoda 4D0 419 801 B

Skoda 4D0 419 801 E

Skoda 4D0 419 801 L

Skoda 8E0 419 801 B

Volkswagen 4B0 419 801 B

Volkswagen 4B0 419 801 M

Volkswagen 4D0 419 801 B

Volkswagen 4D0 419 801 E

Volkswagen 4D0 419 801 L

Volkswagen 8E0 419 801 B

Volkswagen (SVW) 4B0 419 801 E

Volkswagen (SVW) 4B0 419 801 M

Volkswagen (SVW) 4D0 422 821 A

**Application info**

Audi A4 Cabriolet (8H\_) (01/02-12/09)  
 Audi A4 II (8E\_) (02/00-12/05)  
 Audi A8 I (4D\_) (03/94-12/05)  
 Skoda Superb I (3U) (12/01-03/08)

Audi A4 I (8D\_) (11/94-12/02)  
 Audi A6 II (4B, C5) (01/97-12/05)  
 Audi Allroad (4BH) (05/00-08/05)  
 Volkswagen Passat (3B\_) (08/96-12/05)

**Tie rod assembly****116 030 8231****MTA0085****Notes**

Front Axle Left  
 for vehicles with power steering

Length [mm] 612  
 Paired article number 116 030 8232 | MTA0086  
 Required quantity 1  
 Thread Size 1 M12x1,5  
 replacement in pairs recommended

**References**

Audi 4A0 419 801 A

Audi (FAW) 4A0 419 801 A

**Application info**

Audi 100 (4A, C4) (12/90-11/94)

Audi A6 I (4A, C4) (06/94-12/97)

**Tie rod assembly****116 030 8232****MTA0086****Notes**

Front Axle Right  
 for vehicles with power steering

Length [mm] 612  
 Paired article number 116 030 8231 | MTA0085  
 Required quantity 1  
 Thread Size 1 M12x1,5  
 replacement in pairs recommended

**References**

Audi 4A0 419 802 A

Audi (FAW) 4A0 419 802 A

**Application info**

Audi 100 (4A, C4) (12/90-11/94)

Audi A6 I (4A, C4) (06/94-12/97)

## Tie rod assembly

116 030 8260/HD

MTA0093HD

## Notes

Carbon Neutral  
 Front Axle Right  
 for vehicles with power steering

Paired article number  
 116 030 8261/HD | MTA0094HD

Required quantity  
 1

Thread Size 1  
 M12x1,5

Thread Size 2  
 M14x1,5

Paired article number

Required quantity

Thread Size 1

Thread Size 2

reinforced version

replacement in pairs recommended



## References

Ford 1 001 396

Ford 1 092 376

Ford 95VW-3280-AF

Ford 95VW-3280-AH

Seat 7M0 422 804 F

Seat 7M3 422 804

Volkswagen 7M0 422 804 F

Volkswagen 7M3 422 804

Ford 1 020 496

Ford 1 092 377

Ford 95VW-3280-AG

Ford 95VW-3280-BC

Seat 7M0 422 804 G

Seat 7M3 422 804 A

Volkswagen 7M0 422 804 G

Volkswagen 7M3 422 804 A

## Application info

Ford Galaxy I (03/95-05/06)

Volkswagen Sharan (7M) (05/95-03/10)

Seat Alhambra I (7V8, 7V9) (03/96-03/10)

## Tie rod assembly

116 030 8261/HD

MTA0094HD

## Notes

Carbon Neutral  
 Front Axle Left  
 for vehicles with power steering

Paired article number  
 116 030 8260/HD | MTA0093HD

Required quantity  
 1

Thread Size 1  
 M12x1,5

Thread Size 2  
 M14x1,5

Paired article number

Required quantity

Thread Size 1

Thread Size 2

reinforced version

replacement in pairs recommended



**References**

- |                          |                          |
|--------------------------|--------------------------|
| Ford 1 001 398           | Ford 1 020 497           |
| Ford 1 092 382           | Ford 1 121 509           |
| Ford 95VW-3281-AF        | Ford 95VW-3281-AG        |
| Ford 95VW-3281-AH        | Ford YM21-3281-AA        |
| Seat 7M0 422 803 F       | Seat 7M0 422 803 G       |
| Seat 7M3 422 803         | Seat 7M3 422 803 A       |
| Volkswagen 7M0 422 803 F | Volkswagen 7M0 422 803 G |
| Volkswagen 7M3 422 803   | Volkswagen 7M3 422 803 A |

**Application info**

- |                                      |  |
|--------------------------------------|--|
| Ford Galaxy I (03/95-05/06)          | Seat Alhambra I (7V8, 7V9) (03/96-03/10) |
| Volkswagen Sharan (7M) (05/95-03/10) |  |

**Tie rod assembly**

116 030 8314/HD MTA0112HD

**Notes**

- Carbon Neutral  
 Front Axle Right  
 Paired article number 116 030 8315/HD | MTA0113HD  
 Required quantity 1  
 Thread Size 1 M12x1,5  
 Thread Size 2 M16x1,5  
 reinforced version  
 replacement in pairs recommended



**References**

- |                          |                          |
|--------------------------|--------------------------|
| Volkswagen 701 419 804 E | Volkswagen 701 419 804 F |
|--------------------------|--------------------------|

**Application info**

- Volkswagen Transporter IV (07/90-06/03)

**Tie rod assembly**

116 030 8315/HD MTA0113HD

**Notes**

- Carbon Neutral  
 Front Axle Left  
 Paired article number 116 030 8314/HD | MTA0112HD  
 Required quantity 1  
 Thread Size 1 M12x1,5  
 Thread Size 2 M14x1,5  
 reinforced version  
 replacement in pairs recommended



**References**

Volkswagen 702 419 803 C

Volkswagen 702 419 803 D

**Application info**

Volkswagen Transporter IV (07/90-06/03)

**Tie rod assembly****116 030 8500****MTA0115****Notes**

Front Axle Left  
for vehicles with power steering

Manufacturer Restriction

ZF

Paired article number

116 030 8501 | MTA0116

Required quantity

1

Thread Size 1

M12x1,5

Thread Size 2

M16x1,5

replacement in pairs recommended

**References**

Audi 1J0 422 803 B

Seat 1J0 422 803 B

Skoda 1J0 422 803 B

Volkswagen 1J0 422 803 B

Volkswagen (FAW) 1J0 422 803 B

Volkswagen (FAW) 1JD 422 803

Volkswagen (SVW) 1JD 422 803

Audi 1J0 422 803 H

Seat 1J0 422 803 H

Skoda 1J0 422 803 H

Volkswagen 1J0 422 803 H

Volkswagen (FAW) 1J0 422 803 H

Volkswagen (FAW) L1JD 422 803

**Application info**

Audi A3 I (8L\_) (09/96-09/06)

Skoda Octavia I (1U\_) (09/96-12/10)

Volkswagen Golf IV (1J1, 1J5) (08/97-06/14)

Seat Leon I / Toledo II (1M\_) (10/98-06/06)

Volkswagen Bora (1J2, 1J6) (10/98-12/13)

Volkswagen New Beetle (1Y7, 9C1, 1C1) (01/98-12/11)

**Tie rod assembly****116 030 8501****MTA0116****Notes**

Front Axle Right  
for vehicles with power steering

Manufacturer Restriction

ZF

Paired article number

116 030 8500 | MTA0115

Required quantity

1

Thread Size 1

M12x1,5

Thread Size 2

M16x1,5

replacement in pairs recommended



**References**

Audi 1J0 422 804 B	Audi 1J0 422 804 H
Seat 1J0 422 804 B	Seat 1J0 422 804 H
Skoda 1J0 422 804 B	Skoda 1J0 422 804 H
Volkswagen 1J0 422 804 B	Volkswagen 1J0 422 804 H
Volkswagen (FAW) 1J0 422 804 B	Volkswagen (FAW) 1J0 422 804 H
Volkswagen (FAW) 1JD 422 804	Volkswagen (FAW) L1JD 422 804
Volkswagen (SVW) 1JD 422 804	

**Application info**

Audi A3 I (8L_) (09/96-09/06)	Seat Leon I / Toledo II (1M_) (10/98-06/06)
Skoda Octavia I (1U_) (09/96-12/10)	Volkswagen Bora (1J2, 1J6) (10/98-12/13)
Volkswagen Golf IV (1J1, 1J5) (08/97-06/14)	Volkswagen New Beetle (1Y7, 9C1, 1C1) (01/98-12/11)

**Tie rod assembly**

**116 030 9007 MTA0118**

**Notes**

Front Axle Left  
 Front Axle Right  
 for vehicles without power steering

Length [mm] 324  
 Required quantity 2  
 Thread Size 1 M10x1,0  
 Thread Size 2 M10x1,0  
 replacement in pairs recommended



**References**

Volkswagen 113 415 801

**Application info**

Volkswagen Käfer / Karmann Ghia (12/47-08/03)

**Tie rod assembly**

**116 030 9011 MTA0120**

**Notes**

Front Axle Left  
 for vehicles without power steering

Required quantity 1  
 Thread Size 1 M10x1,0  
 Thread Size 2 M10x1,0  
 replacement in pairs recommended



**References**

Volkswagen 211 415 801 D

**Application info**

Volkswagen Transporter I (01/50-10/70)

**Tie rod assembly**

116 030 9016

MTA0124

**Notes**

Front Axle Right

Required quantity

1

Thread Size 1

M10x1,0

Thread Size 2

M10x1,0

replacement in pairs recommended



**References**

Volkswagen 211 415 802 2

Volkswagen 211 415 802 D

**Application info**

Volkswagen Transporter I (01/50-10/70)

Volkswagen Transporter II (08/67-09/79)

**Tie rod assembly**

116 040 0653

MTA0125

**Notes**

Front Axle Right

Paired article number

116 030 0652 | MTA0054

Required quantity

1

Thread Size 1

M12x1,25

Thread Size 2

M12x1,25

replacement in pairs recommended



**References**

Volkswagen 211 415 802 E

Volkswagen 211 415 802 F

**Application info**

Volkswagen Transporter II (08/67-09/79)



**Tie rod assembly**

116 040 0654

MTA0126

**Notes**

Centre  
Front Axle  
with left-hand thread

Required quantity

1

Thread Size 1

M12x1,5

Thread Size 2

M12x1,5

replacement in pairs recommended

**References**

Volkswagen 211 415 701 G

**Application info**

Volkswagen Transporter II (08/67-09/79)

**Tie rod end**

016 020 0000

MTE0001

**Notes**

Front Axle Left  
Front Axle Right

Length [mm]

88

Required quantity

2

Thread Size 2

M14x1,5

replacement in pairs recommended

**References**

Smart 0004887V004000000

Smart 0004887V005000000

Smart 0004887V006

Smart 0004887V006000000

Smart 04887V002000

Smart 04887V004000

Smart 04887V005000

Smart 4887V002000000

Smart 4887V004000000

Smart 4887V005000000

Smart 4887V006000000



**Application info**

Smart City Coupé / Cabrio (07/98-01/04)

Smart Crossblade (06/02-12/03)

Smart Fortwo I (01/04-02/07)

Smart Roadster (04/03-11/05)

Tie rod end		016 020 0001/HD	MTE0002HD								
<p><b>Notes</b></p> <p>Carbon Neutral Front Axle Right</p> <p>Length [mm] 205</p> <p>Paired article number 016 020 0026/HD   MTE0017HD</p> <p>Required quantity 1</p> <p>Thread Size 1 M14x1,5</p> <p>Thread Size 2 M16x1,5</p> <p>reinforced version</p> <p>replacement in pairs recommended</p>											
<p><b>References</b></p> <table border="0"> <tr> <td>Mercedes-Benz 163 330 02 03</td> <td>Mercedes-Benz 163 330 04 03</td> </tr> <tr> <td>Mercedes-Benz 163 338 01 15</td> <td>Mercedes-Benz 163 338 04 15</td> </tr> <tr> <td>Mercedes-Benz A 163 330 02 03</td> <td>Mercedes-Benz A 163 330 04 03</td> </tr> <tr> <td>Mercedes-Benz A 163 338 01 15</td> <td>Mercedes-Benz A 163 338 04 15</td> </tr> </table>				Mercedes-Benz 163 330 02 03	Mercedes-Benz 163 330 04 03	Mercedes-Benz 163 338 01 15	Mercedes-Benz 163 338 04 15	Mercedes-Benz A 163 330 02 03	Mercedes-Benz A 163 330 04 03	Mercedes-Benz A 163 338 01 15	Mercedes-Benz A 163 338 04 15
Mercedes-Benz 163 330 02 03	Mercedes-Benz 163 330 04 03										
Mercedes-Benz 163 338 01 15	Mercedes-Benz 163 338 04 15										
Mercedes-Benz A 163 330 02 03	Mercedes-Benz A 163 330 04 03										
Mercedes-Benz A 163 338 01 15	Mercedes-Benz A 163 338 04 15										
<p><b>Application info</b></p> <p>Mercedes-Benz BM 163 (M-Class) (02/98-07/05)</p>											
Tie rod end		016 020 0001	MTE0002								
<p><b>Notes</b></p> <p>Front Axle Right</p> <p>Length [mm] 205</p> <p>Paired article number 016 020 0026   MTE0017</p> <p>Required quantity 1</p> <p>Thread Size 1 M14x1,5</p> <p>Thread Size 2 M16x1,5</p> <p>replacement in pairs recommended</p>											
<p><b>References</b></p> <table border="0"> <tr> <td>Mercedes-Benz 163 330 02 03</td> <td>Mercedes-Benz 163 330 04 03</td> </tr> <tr> <td>Mercedes-Benz 163 338 01 15</td> <td>Mercedes-Benz 163 338 04 15</td> </tr> <tr> <td>Mercedes-Benz A 163 330 02 03</td> <td>Mercedes-Benz A 163 330 04 03</td> </tr> <tr> <td>Mercedes-Benz A 163 338 01 15</td> <td>Mercedes-Benz A 163 338 04 15</td> </tr> </table>				Mercedes-Benz 163 330 02 03	Mercedes-Benz 163 330 04 03	Mercedes-Benz 163 338 01 15	Mercedes-Benz 163 338 04 15	Mercedes-Benz A 163 330 02 03	Mercedes-Benz A 163 330 04 03	Mercedes-Benz A 163 338 01 15	Mercedes-Benz A 163 338 04 15
Mercedes-Benz 163 330 02 03	Mercedes-Benz 163 330 04 03										
Mercedes-Benz 163 338 01 15	Mercedes-Benz 163 338 04 15										
Mercedes-Benz A 163 330 02 03	Mercedes-Benz A 163 330 04 03										
Mercedes-Benz A 163 338 01 15	Mercedes-Benz A 163 338 04 15										
<p><b>Application info</b></p> <table border="0"> <tr> <td>Mercedes-Benz BM 163 (M-Class) (02/98-07/05)</td> <td>Mercedes-Benz BM 164 (M-Class) (02/05-12/12)</td> </tr> </table>				Mercedes-Benz BM 163 (M-Class) (02/98-07/05)	Mercedes-Benz BM 164 (M-Class) (02/05-12/12)						
Mercedes-Benz BM 163 (M-Class) (02/98-07/05)	Mercedes-Benz BM 164 (M-Class) (02/05-12/12)										

## Tie rod end

016 020 0002

MTE0003

## Notes

Front Axle Left  
Front Axle Right

Length [mm] 190  
Required quantity 2  
Thread Size 1 M14x1,5  
Thread Size 2 M14x1,5  
replacement in pairs recommended



## References

Mercedes-Benz 220 338 05 15  
Mercedes-Benz 230 330 02 03  
Mercedes-Benz 230 338 01 15  
Mercedes-Benz A 220 338 10 15  
Mercedes-Benz A 230 330 04 03

Mercedes-Benz 220 338 10 15  
Mercedes-Benz 230 330 04 03  
Mercedes-Benz A 220 338 05 15  
Mercedes-Benz A 230 330 02 03  
Mercedes-Benz A 230 338 01 15

## Application info

Mercedes-Benz BM 215 (S-Class) (03/99-12/06)  
Mercedes-Benz BM 220 (S-Class) (09/98-08/05)

Mercedes-Benz BM 219 (CLS) (10/04-02/11)  
Mercedes-Benz BM 230 (SL) (10/01-01/12)

## Tie rod end

016 020 0003

MTE0004

## Notes

Front Axle Left

Length [mm] 205  
Paired article number 016 020 0004 | MTE0005  
Required quantity 1  
Thread Size 1 M12x1,5  
Thread Size 2 M12x1,5  
replacement in pairs recommended



## References

Mercedes-Benz 168 330 11 35  
Mercedes-Benz A 168 330 11 35

Mercedes-Benz 168 330 15 35  
Mercedes-Benz A 168 330 15 35

## Application info

Mercedes-Benz BM 168 (A-Class) (07/97-08/05)

## Tie rod end

016 020 0004

MTE0005

## Notes

Front Axle Right

Length [mm]

205

Paired article number

016 020 0003 | MTE0004

Required quantity

1

Thread Size 1

M12x1,5

Thread Size 2

M12x1,5

replacement in pairs recommended



## References

Mercedes-Benz 168 330 12 35

Mercedes-Benz 168 330 16 35

Mercedes-Benz A 168 330 12 35

Mercedes-Benz A 168 330 16 35

## Application info

Mercedes-Benz BM 168 (A-Class) (07/97-08/05)

## Tie rod end

016 020 0007

MTE0006

## Notes

Front Axle Left

Length [mm]

200

Paired article number

016 020 0031 | MTE0018

Required quantity

1

Thread Size 1

M14x1,5

Thread Size 2

M14x1,5

replacement in pairs recommended



## References

Mercedes-Benz 169 330 05 03



Mercedes-Benz A 169 330 05 03





## Application info



Mercedes-Benz BM 168 (A-Class) (07/97-08/05)



Mercedes-Benz BM 169 (A-Class) (09/04-06/12)

Mercedes-Benz BM 245 (B-Class) (03/05-11/11)

Tie rod end		016 020 0008	MTE0007
<b>Notes</b>  Front Axle Left Length [mm] 221 Paired article number 016 020 0009   MTE0008 Required quantity 1 Thread Size 1 M14x1,5 Thread Size 2 M14x1,5 replacement in pairs recommended			
<b>References</b> Mercedes-Benz 164 330 11 03		Mercedes-Benz A 164 330 11 03	
<b>Application info</b> Mercedes-Benz BM 164 (GL-Class) (09/06-12/12) Mercedes-Benz BM 463 (G-Class) (09/89--)		Mercedes-Benz BM 164 (M-Class) (02/05-12/12)	
Tie rod end		016 020 0009	MTE0008
<b>Notes</b>  Front Axle Right Length [mm] 221 Paired article number 016 020 0008   MTE0007 Required quantity 1 Thread Size 1 M14x1,5 Thread Size 2 M14x1,5 replacement in pairs recommended			
<b>References</b> Mercedes-Benz 164 330 12 03		Mercedes-Benz A 164 330 12 03	
<b>Application info</b> Mercedes-Benz BM 164 (GL-Class) (09/06-12/12) Mercedes-Benz BM 463 (G-Class) (09/89--)		Mercedes-Benz BM 164 (M-Class) (02/05-12/12)	

Tie rod end		016 020 0013/HD	MTE0009HD
<b>Notes</b>  Carbon Neutral Front Axle Left Front Axle Right  Length [mm] 73 Required quantity 2 Thread Size 1 M10x1,5 Thread Size 2 M12x1,25 reinforced version replacement in pairs recommended		 	
<b>References</b> Mitsubishi MR977606 Smart A 454 460 02 05		Smart 454 460 02 05	
<b>Application info</b> Mitsubishi Colt VI (10/02-12/12)		Smart Forfour (01/04-06/06)	
Tie rod end		016 020 0015	MTE0010
<b>Notes</b>  Front Axle Left Front Axle Right  Length [mm] 185 Required quantity 2 Thread Size 1 M14x1,5 Thread Size 2 M14x1,5 replacement in pairs recommended		 	
<b>References</b> Mercedes-Benz 221 330 15 03 Mercedes-Benz A 221 330 15 03		Mercedes-Benz 221 330 39 03 Mercedes-Benz A 221 330 39 03	
<b>Application info</b> Mercedes-Benz BM 216 (S-Class) (05/06-12/13)		Mercedes-Benz BM 221 (S-Class) (09/05-12/13)	

Tie rod end		016 020 0018	MTE0013
<b>Notes</b>  Front Axle Left Length [mm] 203 Paired article number 016 020 0019   MTE0014 Required quantity 1 Thread Size 1 M14x1,5 Thread Size 2 M14x1,5 replacement in pairs recommended			
<b>References</b> Mercedes-Benz 212 330 23 03 Mercedes-Benz A 212 330 23 03		Mercedes-Benz 218 330 03 00 Mercedes-Benz A 218 330 03 00	
<b>Application info</b> Mercedes-Benz BM 212 (E-Class) (01/09-12/16)		Mercedes-Benz BM 218 (CLS) (01/11-12/17)	
Tie rod end		016 020 0019	MTE0014
<b>Notes</b>  Front Axle Right Length [mm] 203 Paired article number 016 020 0018   MTE0013 Required quantity 1 Thread Size 1 M14x1,5 Thread Size 2 M14x1,5 replacement in pairs recommended			
<b>References</b> Mercedes-Benz 212 330 22 03 Mercedes-Benz A 212 330 22 03		Mercedes-Benz 218 330 04 00 Mercedes-Benz A 218 330 04 00	
<b>Application info</b> Mercedes-Benz BM 212 (E-Class) (01/09-12/16)		Mercedes-Benz BM 218 (CLS) (01/11-12/17)	

Tie rod end		016 020 0020/HD	MTE0015HD
<b>Notes</b>  Carbon Neutral Front Axle Left  Length [mm] 232 Paired article number 016 020 0021/HD   MTE0016HD Required quantity 1 Thread Size 1 M14x1,5 Thread Size 2 M14x1,5 reinforced version replacement in pairs recommended			
<b>References</b> Mercedes-Benz 246 330 17 00 Mercedes-Benz (BBDC) 246 330 17 00		Mercedes-Benz A 246 330 17 00 Mercedes-Benz (BBDC) A 246 330 17 00	
<b>Application info</b> Mercedes-Benz BM 117 (CLA) (01/13-03/19) Mercedes-Benz BM 176 (A-Class) (06/12-05/18)		Mercedes-Benz BM 156 (GLA-Class) (12/13--) Mercedes-Benz BM 246 (B-Class) (10/11-12/18)	
Tie rod end		016 020 0021/HD	MTE0016HD
<b>Notes</b>  Carbon Neutral Front Axle Right  Length [mm] 232 Paired article number 016 020 0020/HD   MTE0015HD Required quantity 1 Thread Size 1 M14x1,5 Thread Size 2 M14x1,5 reinforced version replacement in pairs recommended			
<b>References</b> Mercedes-Benz 246 330 18 00		Mercedes-Benz A 246 330 18 00	
<b>Application info</b> Mercedes-Benz BM 117 (CLA) (01/13-03/19) Mercedes-Benz BM 176 (A-Class) (06/12-05/18)		Mercedes-Benz BM 156 (GLA-Class) (12/13--) Mercedes-Benz BM 246 (B-Class) (10/11-12/18)	



## Tie rod end

016 020 0023/HD

MTE0752HD

## Notes

Carbon Neutral

Front Axle Left

Length [mm]

204

Paired article number

016 020 0024/HD | MTE0753HD

Required quantity

1

Thread Size 1

14x1,5

Thread Size 2

14x1,5

reinforced version

replacement in pairs recommended



## References

Mercedes-Benz 212 330 81 00

Mercedes-Benz A 212 330 81 00

Mercedes-Benz (BBDC) 212 330 81 00

Mercedes-Benz (BBDC) A 212 330 81 00

## Application info

Mercedes-Benz BM 212 (E-Class) (01/09-12/16)

## Tie rod end

016 020 0024/HD

MTE0753HD

## Notes

Carbon Neutral

Front Axle Right

Length [mm]

204

Paired article number

016 020 0023/HD | MTE0752HD

Required quantity

1

Thread Size 1

14x1,5

Thread Size 2

14x1,5

reinforced version

replacement in pairs recommended



## References

Mercedes-Benz 212 330 82 00

Mercedes-Benz A 212 330 82 00

Mercedes-Benz (BBDC) 212 330 82 00

Mercedes-Benz (BBDC) A 212 330 82 00

## Application info

Mercedes-Benz BM 212 (E-Class) (01/09-12/16)

**Tie rod end**

016 020 0026

MTE0017

**Notes**

Front Axle Left  
 Length [mm] 205  
 Paired article number 016 020 0001 | MTE0002  
 Required quantity 1  
 Thread Size 1 M14x1,5  
 Thread Size 2 M16x1,5  
 replacement in pairs recommended



**References**

Mercedes-Benz 163 330 00 03	Mercedes-Benz 163 330 01 03
Mercedes-Benz 163 338 00 15	Mercedes-Benz 163 338 03 15
Mercedes-Benz A 163 330 00 03	Mercedes-Benz A 163 330 01 03
Mercedes-Benz A 163 338 00 15	Mercedes-Benz A 163 338 03 15

**Application info**

Mercedes-Benz BM 163 (M-Class) (02/98-07/05)	Mercedes-Benz BM 164 (M-Class) (02/05-12/12)
--	--

**Tie rod end**

016 020 0026/HD

MTE0017HD

**Notes**

Carbon Neutral  
 Front Axle Left  
 Length [mm] 205  
 Paired article number 016 020 0001/HD | MTE0002HD  
 Required quantity 1  
 Thread Size 1 M14x1,5  
 Thread Size 2 M16x1,5  
 reinforced version  
 replacement in pairs recommended



**References**

Mercedes-Benz 163 330 00 03	Mercedes-Benz 163 330 01 03
Mercedes-Benz 163 338 00 15	Mercedes-Benz 163 338 03 15
Mercedes-Benz A 163 330 00 03	Mercedes-Benz A 163 330 01 03
Mercedes-Benz A 163 338 00 15	Mercedes-Benz A 163 338 03 15

**Application info**

Mercedes-Benz BM 163 (M-Class) (02/98-07/05)

## Tie rod end

016 020 0031

MTE0018

## Notes

Front Axle Right

Length [mm]

200

Paired article number

016 020 0007 | MTE0006

Required quantity

1

Thread Size 1

M14x1,5

Thread Size 2

M14x1,5

replacement in pairs recommended



## References

Mercedes-Benz 169 330 06 03

Mercedes-Benz A 169 330 06 03

## Application info

Mercedes-Benz BM 168 (A-Class) (07/97-08/05)

Mercedes-Benz BM 169 (A-Class) (09/04-06/12)

Mercedes-Benz BM 245 (B-Class) (03/05-11/11)

## Tie rod end

016 020 0034

MTE0019

## Notes

Front Axle Left

Length [mm]

167

Paired article number

016 020 0035 | MTE0020

Required quantity

1

Thread Size 1

M14x1,5

Thread Size 2

M16x1,5

replacement in pairs recommended



## References

MERCEDES-BENZ (FJDA) 639 460 04 48

MERCEDES-BENZ (FJDA) A 639 460 04 48

Mercedes-Benz 639 460 00 48

Mercedes-Benz 639 460 04 48

Mercedes-Benz 639 460 06 48

Mercedes-Benz A 639 460 00 48

Mercedes-Benz A 639 460 04 48

Mercedes-Benz A 639 460 06 48

## Application info

Mercedes-Benz BM 639 (Vito / Viano) (08/03--)

**Tie rod end**

016 020 0035

MTE0020

**Notes**

Front Axle Right  
 Length [mm] 167  
 Paired article number 016 020 0034 | MTE0019  
 Required quantity 1  
 Thread Size 1 M14x1,5  
 Thread Size 2 M16x1,5  
 replacement in pairs recommended



**References**

MERCEDES-BENZ (FJDA) 639 460 05 48	MERCEDES-BENZ (FJDA) A 639 460 05 48
Mercedes-Benz 639 460 03 48	Mercedes-Benz 639 460 05 48
Mercedes-Benz 639 460 07 48	Mercedes-Benz A 639 460 03 48
Mercedes-Benz A 639 460 05 48	Mercedes-Benz A 639 460 07 48

**Application info**

Mercedes-Benz BM 639 (Vito / Viano) (08/03--)

**Tie rod end**

016 020 0037/HD

MTE0838HD

**Notes**

Carbon Neutral  
 Front Axle Left  
 Front Axle Right  
 Length [mm] 174  
 Required quantity 2  
 Thread Size 1 14x1,5  
 Thread Size 2 14x1,5

reinforced version  
 replacement in pairs recommended



**References**

Mercedes-Benz 231 330 11 00	Mercedes-Benz A 231 330 11 00
-----------------------------	-------------------------------

**Application info**

Mercedes-Benz BM 231 (SL) (01/12--)

## Tie rod end

016 020 0038

MTE0021

## Notes

Front Axle Left  
Front Axle Right

Length [mm] 90  
Required quantity 2  
Thread Size 1 M14x1,5  
Thread Size 2 M16x1,5  
replacement in pairs recommended



## References

Mercedes-Benz 906 460 00 48  
Mercedes-Benz 906 460 03 48  
Mercedes-Benz A 906 460 01 48  
Volkswagen 2E0 498 104  
Volkswagen 2E0 713 501

Mercedes-Benz 906 460 01 48  
Mercedes-Benz A 906 460 00 48  
Mercedes-Benz A 906 460 03 48  
Volkswagen 2E0 498 104 A

## Application info

Mercedes-Benz BM 906 (Sprinter II) (06/06--)  
Volkswagen Crafter I (2E) (04/06-12/16)

Mercedes-Benz BM 907 / 910 (Sprinter III) (02/18--)

## Tie rod end

016 020 0039/HD

MTE0022HD

## Notes

Carbon Neutral  
Front Axle Right

Length [mm] 205  
Paired article number 016 020 0040/HD | MTE0023HD  
Required quantity 1  
Thread Size 1 M14x1,5  
Thread Size 2 M14x1,5  
reinforced version  
replacement in pairs recommended



## References

Mercedes-Benz 414 460 01 05

Mercedes-Benz A 414 460 01 05

## Application info

Mercedes-Benz BM 414 (Vaneo) (02/02-07/05)

## Tie rod end

016 020 0040/HD

MTE0023HD

## Notes

Carbon Neutral  
 Front Axle Left  
 Length [mm] 205  
 Paired article number 016 020 0039/HD | MTE0022HD  
 Required quantity 1  
 Thread Size 1 M14x1,5  
 Thread Size 2 M14x1,5  
 reinforced version  
 replacement in pairs recommended



## References

Mercedes-Benz 414 460 00 05

Mercedes-Benz A 414 460 00 05

## Application info

Mercedes-Benz BM 414 (Vaneo) (02/02-07/05)

## Tie rod end

016 020 0041

MTE0024

## Notes

Front Axle Left  
 Front Axle Right  
 Length [mm] 77  
 Required quantity 2  
 Thread Size 1 M14x1,5  
 Thread Size 2 M14x1,5  
 replacement in pairs recommended



## References



Mercedes-Benz 901 460 02 48



Mercedes-Benz A 901 460 02 48

## Application info

Mercedes-Benz BM 903 (Sprinter I) (01/95-05/12)

Mercedes-Benz BM 904 (Sprinter I) (02/95-05/12)

Tie rod end		016 020 0042/HD	MTE0834HD
<p><b>Notes</b></p> <p>Carbon Neutral Front Axle Left Front Axle Right</p> <p>Length [mm] 175 Required quantity 2 Thread Size 1 M14x1,5 Thread Size 2 M16x1,5 reinforced version replacement in pairs recommended</p>			
<p><b>References</b></p> <p>Mercedes-Benz 222 330 70 00</p>		<p>Mercedes-Benz A 222 330 70 00</p>	
<p><b>Application info</b></p> <p>Mercedes-Benz BM 217 (S-Class) (12/15--)</p>		<p>Mercedes-Benz BM 222 (S-Class) (05/13--)</p>	
Tie rod end		016 020 0047	MTE0729
<p><b>Notes</b></p> <p>Front Axle Left</p> <p>Length [mm] 227 Paired article number 016 020 0048   MTE0730 Required quantity 1 Thread Size 1 M14x1,5 Thread Size 2 M14x1,5 replacement in pairs recommended</p>			
<p><b>References</b></p> <p>Mercedes-Benz 221 330 19 03 Mercedes-Benz A 221 330 19 03</p>		<p>Mercedes-Benz 221 330 33 03 Mercedes-Benz A 221 330 33 03</p>	
<p><b>Application info</b></p> <p>Mercedes-Benz BM 216 (S-Class) (05/06-12/13)</p>		<p>Mercedes-Benz BM 221 (S-Class) (09/05-12/13)</p>	

Tie rod end		016 020 0048	MTE0730
<p><b>Notes</b></p> <p>Front Axle Right</p> <p>Length [mm] 227</p> <p>Paired article number 016 020 0047   MTE0729</p> <p>Required quantity 1</p> <p>Thread Size 1 M14x1,5</p> <p>Thread Size 2 M14x1,5</p> <p>replacement in pairs recommended</p>			
<p><b>References</b></p> <p>Mercedes-Benz 221 330 20 03 Mercedes-Benz 221 330 34 03</p> <p>Mercedes-Benz A 221 330 20 03 Mercedes-Benz A 221 330 34 03</p>			
<p><b>Application info</b></p> <p>Mercedes-Benz BM 216 (S-Class) (05/06-12/13) Mercedes-Benz BM 221 (S-Class) (09/05-12/13)</p>			
Tie rod end		016 020 0049/HD	MTE0652HD
<p><b>Notes</b></p> <p>Carbon Neutral</p> <p>Front Axle Left</p> <p>Front Axle Right</p> <p>Length [mm] 180</p> <p>Required quantity 2</p> <p>Thread Size 1 M14x1,5</p> <p>Thread Size 2 M16x1,5</p> <p>reinforced version</p> <p>replacement in pairs recommended</p>			
<p><b>References</b></p> <p>Mercedes-Benz 166 330 04 03 Mercedes-Benz A 166 330 04 03</p>			
<p><b>Application info</b></p> <p>Mercedes-Benz BM 166 (GL) (07/12-12/15) Mercedes-Benz BM 166 (GLE) (03/15-10/19)</p> <p>Mercedes-Benz BM 166 (GLS) (11/15-04/19) Mercedes-Benz BM 166 (M-Class) (06/11-12/15)</p>			



**Tie rod end**

016 020 0049

MTE0652

**Notes**

Front Axle Left  
 Front Axle Right  
 Length [mm] 180  
 Required quantity 2  
 Thread Size 1 M14x1,5  
 Thread Size 2 M16x1,5  
 replacement in pairs recommended



**References**

Mercedes-Benz 166 330 04 03

Mercedes-Benz A 166 330 04 03

**Application info**

Mercedes-Benz BM 166 (GL) (07/12-12/15)  
 Mercedes-Benz BM 166 (GLS) (11/15-04/19)

Mercedes-Benz BM 166 (GLE) (03/15-10/19)  
 Mercedes-Benz BM 166 (M-Class) (06/11-12/15)

**Tie rod end**

016 020 0050/HD

MTE0771HD

**Notes**

Carbon Neutral  
 Front Axle Right  
 Length [mm] 194  
 Paired article number 016 020 0051/HD | MTE0772HD  
 Required quantity 1  
 Thread Size 1 M14X1,5  
 Thread Size 2 M14X1,5  
 reinforced version  
 replacement in pairs recommended



**References**

Mercedes-Benz 205 460 07 05

Mercedes-Benz A 205 460 07 05

Mercedes-Benz (BBDC) 205 460 07 05

Mercedes-Benz (BBDC) A 205 460 07 05

**Application info**

Mercedes-Benz BM 205 (C-Class) (12/13--)  
 Mercedes-Benz BM 238 (E-Class) (06/17--)

Mercedes-Benz BM 213 (E-Class) (01/16--)  
 Mercedes-Benz BM 257 (CLS-Class) (12/17--)

## Tie rod end

016 020 0051/HD

MTE0772HD

## Notes

Carbon Neutral

Front Axle Left

Length [mm]

194

Paired article number

016 020 0050/HD | MTE0771HD

Required quantity

1

Thread Size 1

M14X1,5

Thread Size 2

M14X1,5

reinforced version

replacement in pairs recommended



## References

Mercedes-Benz 205 460 06 05

Mercedes-Benz A 205 460 06 05

Mercedes-Benz (BBDC) 205 460 06 05

Mercedes-Benz (BBDC) A 205 460 06 05

## Application info

Mercedes-Benz BM 205 (C-Class) (12/13--)

Mercedes-Benz BM 213 (E-Class) (01/16--)

Mercedes-Benz BM 238 (E-Class) (06/17--)

Mercedes-Benz BM 257 (CLS-Class) (12/17--)

## Tie rod end

016 020 0052/HD

MTE0712HD

## Notes

Carbon Neutral

Front Axle Right

Length [mm]

224

Paired article number

016 020 0053/HD | MTE0713HD

Required quantity

1

Thread Size 1

M14x1,5

Thread Size 2

M14x1,5

reinforced version

replacement in pairs recommended





## References



Mercedes-Benz 222 330 02 03





Mercedes-Benz A 222 330 02 03

## Application info

Mercedes-Benz BM 222 (S-Class) (05/13--)

Tie rod end		016 020 0053/HD	MTE0713HD
<b>Notes</b>  Carbon Neutral Front Axle Left Length [mm] 224 Paired article number 016 020 0052/HD   MTE0712HD Required quantity 1 Thread Size 1 M14x1,5 Thread Size 2 M14x1,5 reinforced version replacement in pairs recommended			
<b>References</b> Mercedes-Benz 222 330 01 03		Mercedes-Benz A 222 330 01 03	
<b>Application info</b> Mercedes-Benz BM 222 (S-Class) (05/13--)			
Tie rod end		016 020 0054	MTE0714
<b>Notes</b>  Front Axle Right Length [mm] 205.5 Paired article number 016 020 0055   MTE0715 Required quantity 1 Thread Size 1 M14x1,5 Thread Size 2 M14x1,5 replacement in pairs recommended			
<b>References</b> Mercedes-Benz 212 330 27 03 Mercedes-Benz A 212 330 27 03 Mercedes-Benz (BBDC) 212 460 02 05		Mercedes-Benz 212 460 02 05 Mercedes-Benz A 212 460 02 05 Mercedes-Benz (BBDC) A 212 460 02 05	
<b>Application info</b> Mercedes-Benz BM 212 (E-Class) (01/09-12/16)			
Mercedes-Benz BM 218 (CLS) (01/11-12/17)			

Tie rod end		016 020 0055	MTE0715
<b>Notes</b>  Front Axle Left Length [mm] 205.5 Paired article number 016 020 0054   MTE0714 Required quantity 1 Thread Size 1 M14x1,5 Thread Size 2 M14x1,5 replacement in pairs recommended			
<b>References</b> Mercedes-Benz 212 330 24 03 Mercedes-Benz 212 460 01 05 Mercedes-Benz A 212 330 24 03 Mercedes-Benz A 212 460 01 05 Mercedes-Benz (BBDC) 212 460 01 05 Mercedes-Benz (BBDC) A 212 460 01 05			
<b>Application info</b> Mercedes-Benz BM 212 (E-Class) (01/09-12/16) Mercedes-Benz BM 218 (CLS) (01/11-12/17)			
Tie rod end		016 020 0056	MTE0731
<b>Notes</b>  Front Axle Right for vehicles with hydraulic power steering Length [mm] 210 Paired article number 016 020 0057   MTE0732 Required quantity 1 Thread Size 1 M14x1,5 Thread Size 2 M14x1,5 replacement in pairs recommended			
<b>References</b> Mercedes-Benz 212 330 14 03 Mercedes-Benz A 212 330 14 03			
<b>Application info</b> Mercedes-Benz BM 212 (E-Class) (01/09-12/16)			

Tie rod end		016 020 0057	MTE0732
<b>Notes</b>  Front Axle Left for vehicles with hydraulic power steering  Length [mm] 212 Paired article number 016 020 0056   MTE0731 Required quantity 1 Thread Size 1 M14x1,5 Thread Size 2 M14x1,5 replacement in pairs recommended		 	
<b>References</b> Mercedes-Benz 212 330 13 03		Mercedes-Benz A 212 330 13 03	
<b>Application info</b> Mercedes-Benz BM 212 (E-Class) (01/09-12/16)			
Tie rod end		016 020 0058/HD	MTE0782HD
<b>Notes</b>  Carbon Neutral Front Axle Right outer  Length [mm] 194 Paired article number 016 020 0059/HD   MTE0783HD Required quantity 1 Thread Size 1 14x1,5 Thread Size 2 16x1,5 reinforced version replacement in pairs recommended		 	
<b>References</b> Mercedes-Benz 447 460 01 48		Mercedes-Benz A 447 460 01 48	
<b>Application info</b> Mercedes-Benz BM 447 (V-Class) (03/14-- )		Mercedes-Benz BM 447 (Vito) (10/14-- )	

## Tie rod end

016 020 0059/HD

MTE0783HD

## Notes

Carbon Neutral  
Front Axle Left  
outer  
Length [mm] 194  
Paired article number 016 020 0058/HD | MTE0782HD  
Required quantity 1  
Thread Size 1 14x1,5  
Thread Size 2 16x1,5  
reinforced version  
replacement in pairs recommended



## References

Mercedes-Benz 447 460 00 48

Mercedes-Benz A 447 460 00 48

## Application info

Mercedes-Benz BM 447 (V-Class) (03/14--)

Mercedes-Benz BM 447 (Vito) (10/14--)

## Tie rod end

016 020 0060

MTE0803

## Notes

Front Axle Right  
outer  
Length [mm] 189  
Paired article number 016 020 0061 | MTE0804  
Required quantity 1  
Thread Size 1 14x1,5  
Thread Size 2 14x1,5  
replacement in pairs recommended



## References

Mercedes-Benz 205 460 01 05

Mercedes-Benz 205 460 46 02

Mercedes-Benz A 205 460 01 05

Mercedes-Benz A 205 460 46 02

## Application info

Mercedes-Benz BM 205 (C-Class) (12/13--)



Mercedes-Benz BM 213 (E-Class) (01/16--)

Mercedes-Benz BM 238 (E-Class) (06/17--)

Mercedes-Benz BM 253 (GLC) (06/15--)

Mercedes-Benz BM 257 (CLS-Class) (12/17--)

Mercedes-Benz BM 293 (EQC) (05/19--)

Tie rod end		016 020 0061	MTE0804
<p><b>Notes</b></p> <p>Front Axle Left outer</p> <p>Length [mm] 189</p> <p>Paired article number 016 020 0060   MTE0803</p> <p>Required quantity 1</p> <p>Thread Size 1 14x1,5</p> <p>Thread Size 2 14x1,5</p> <p>replacement in pairs recommended</p>			
<p><b>References</b></p> <p>Mercedes-Benz 205 460 00 05 Mercedes-Benz 205 460 47 02</p> <p>Mercedes-Benz A 205 460 00 05 Mercedes-Benz A 205 460 47 02</p>			
<p><b>Application info</b></p> <p>Mercedes-Benz BM 205 (C-Class) (12/13--)</p> <p>Mercedes-Benz BM 238 (E-Class) (06/17--)</p> <p>Mercedes-Benz BM 257 (CLS-Class) (12/17--)</p> <p>Mercedes-Benz BM 213 (E-Class) (01/16--)</p> <p>Mercedes-Benz BM 253 (GLC) (06/15--)</p> <p>Mercedes-Benz BM 293 (EQC) (05/19--)</p>			
Tie rod end		016 020 0062/HD	MTE0795HD
<p><b>Notes</b></p> <p>Carbon Neutral</p> <p>Front Axle Right outer</p> <p>Length [mm] 222</p> <p>Paired article number 016 020 0063/HD   MTE0796HD</p> <p>Required quantity 1</p> <p>Thread Size 1 12x1,5</p> <p>Thread Size 2 16x1,5</p> <p>reinforced version</p> <p>replacement in pairs recommended</p>			
<p><b>References</b></p> <p>Mercedes-Benz 447 460 03 48 Mercedes-Benz A 447 460 03 48</p>			
<p><b>Application info</b></p> <p>Mercedes-Benz BM 447 (V-Class) (03/14--)</p> <p>Mercedes-Benz BM 447 (Vito) (10/14--)</p>			

## Tie rod end

016 020 0063/HD

MTE0796HD

## Notes

Carbon Neutral  
Front Axle Left  
outer

Length [mm] 222  
Paired article number 016 020 0062/HD | MTE0795HD  
Required quantity 1  
Thread Size 1 12x1,5  
Thread Size 2 16x1,5  
reinforced version  
replacement in pairs recommended



## References

Mercedes-Benz 447 460 02 48

Mercedes-Benz A 447 460 02 48

## Application info

Mercedes-Benz BM 447 (V-Class) (03/14--)

Mercedes-Benz BM 447 (Vito) (10/14--)

## Tie rod end

016 020 0064/HD

MTE0937HD

## Notes

Carbon Neutral  
Front Axle Right

Length [mm] 222  
Paired article number 016 020 0065/HD | MTE0938HD  
Required quantity 1  
Thread Size 1 M14x1,5  
Thread Size 2 M14x1,5  
reinforced version  
replacement in pairs recommended



## References

Mercedes-Benz 177 330 84 00

Mercedes-Benz A 177 330 84 00

## Application info

Mercedes-Benz BM 118 (CLA) (03/19--)

Mercedes-Benz BM 177 (A-Class) (03/18--)

Mercedes-Benz BM 247 (GLA-Class) (02/20--)



## Tie rod end

016 020 0065/HD

MTE0938HD

## Notes

Carbon Neutral  
 Front Axle Left  
 Length [mm] 222  
 Paired article number 016 020 0064/HD | MTE0937HD  
 Required quantity 1  
 Thread Size 1 M14x1,5  
 Thread Size 2 M14x1,5  
 replacement in pairs recommended



## References

Mercedes-Benz 177 330 85 00

Mercedes-Benz A 177 330 85 00

## Application info

Mercedes-Benz BM 118 (CLA) (03/19--)

Mercedes-Benz BM 177 (A-Class) (03/18--)

Mercedes-Benz BM 247 (GLA-Class) (02/20--)

## Tie rod end

016 020 0066/HD

MTE0947HD

## Notes

Carbon Neutral  
 Front Axle Right  
 outer  
 Length [mm] 209.6  
 Paired article number 016 020 0067/HD | MTE0948HD  
 Required quantity 1  
 Thread Size 1 M14x1,5  
 Thread Size 2 M16x1,5  
 reinforced version  
 replacement in pairs recommended



## References

Mercedes-Benz 910 460 60 00

Mercedes-Benz A 910 460 60 00

## Application info

Mercedes-Benz BM 907 / 910 (Sprinter III) (02/18--)

## Tie rod end

016 020 0067/HD

MTE0948HD

## Notes

Carbon Neutral  
Front Axle Left  
outer

Length [mm] 209.6  
Paired article number 016 020 0066/HD | MTE0947HD  
Required quantity 1  
Thread Size 1 M14x1,5  
Thread Size 2 M16x1,5  
reinforced version  
replacement in pairs recommended



## References

Mercedes-Benz 910 460 61 00

Mercedes-Benz A 910 460 61 00

## Application info

Mercedes-Benz BM 907 / 910 (Sprinter III) (02/18--)

## Tie rod end

016 020 0068/HD

MTE0949HD

## Notes

Carbon Neutral  
Front Axle Right  
outer

Length [mm] 173.7  
Paired article number 016 020 0069/HD | MTE0950HD  
Required quantity 1  
Thread Size 1 M14x1,5  
Thread Size 2 M16x1,5  
reinforced version  
replacement in pairs recommended





## References

Mercedes-Benz 907 460 64 00

Mercedes-Benz A 907 460 64 00

## Application info

Mercedes-Benz BM 907 / 910 (Sprinter III) (02/18--)

Tie rod end		016 020 0069/HD	MTE0950HD
<b>Notes</b>  Carbon Neutral Front Axle Left outer Length [mm] 173.7 Paired article number 016 020 0068/HD   MTE0949HD Required quantity 1 Thread Size 1 M14x1,5 Thread Size 2 M16x1,5 reinforced version replacement in pairs recommended			
<b>References</b> Mercedes-Benz 907 460 62 00		Mercedes-Benz A 907 460 62 00	
<b>Application info</b> Mercedes-Benz BM 907 / 910 (Sprinter III) (02/18-- )			
Tie rod end		016 020 0070	MTE0969
<b>Notes</b>  Front Axle Left Front Axle Right Length [mm] 168 Required quantity 2 Thread Size 1 M14x1,5 Thread Size 2 M16x1,5 replacement in pairs recommended			
<b>References</b> Mercedes-Benz 167 330 71 00		Mercedes-Benz A 167 330 71 00	
<b>Application info</b> Mercedes-Benz BM 167 (GLE) (10/18-- )		Mercedes-Benz BM 167 (GLS) (04/19-- )	

**Tie rod end** **016 020 0071/HD** **MTE0987HD**

**Notes**

	Carbon Neutral
	Front Axle Left
Length [mm]	222
Paired article number	016 020 0072/HD   MTE0988HD
Required quantity	1
Thread Size 1	M14x1,5
Thread Size 2	M14x1,5
replacement in pairs recommended	



**References**

Mercedes-Benz 247 330 85 01	Mercedes-Benz A 247 330 85 01
-----------------------------	-------------------------------

**Application info**

Mercedes-Benz BM 243 (EQA) (02/21--)	Mercedes-Benz BM 243 (EQB) (12/21--)
Mercedes-Benz BM 247 (B-Class) (12/18--)	Mercedes-Benz BM 247 (GLA-Class) (02/20--)

**Tie rod end** **016 020 0072/HD** **MTE0988HD**

**Notes**

	Carbon Neutral
	Front Axle Right
Length [mm]	222
Paired article number	016 020 0071/HD   MTE0987HD
Required quantity	1
Thread Size 1	M14x1,5
Thread Size 2	M14x1,5
reinforced version	
replacement in pairs recommended	







**References**

Mercedes-Benz 247 330 82 01	Mercedes-Benz A 247 330 82 01
-----------------------------	-------------------------------

**Application info**

Mercedes-Benz BM 243 (EQA) (02/21--)	Mercedes-Benz BM 243 (EQB) (12/21--)
Mercedes-Benz BM 247 (B-Class) (12/18--)	Mercedes-Benz BM 247 (GLA-Class) (02/20--)

Tie rod end		016 020 0073/HD	MTE0991HD
<b>Notes</b>	Carbon Neutral Front Axle Left outer		
Length [mm]	222		
Paired article number	016 020 0074/HD   MTE0992HD		
Required quantity	1		
Thread Size 1	M14x1,5		
Thread Size 2	M14X1,5		
replacement in pairs recommended			
<b>References</b>	Mercedes-Benz 247 330 87 01	Mercedes-Benz 247 330 87 01 64	
	Mercedes-Benz A 247 330 86 01	Mercedes-Benz A 247 330 87 01	
<b>Application info</b>	Mercedes-Benz BM 247 (GLB-Class) (08/19--)		
Tie rod end		016 020 0074/HD	MTE0992HD
<b>Notes</b>	Carbon Neutral Front Axle Right outer		
Length [mm]	222		
Paired article number	016 020 0073/HD   MTE0991HD		
Required quantity	1		
Thread Size 1	M14X1,5		
Thread Size 2	M14X1,5		
replacement in pairs recommended			
<b>References</b>	Mercedes-Benz 247 330 86 01	Mercedes-Benz 247 330 86 01 64	
	Mercedes-Benz A 247 330 86 01	Mercedes-Benz A 247 330 86 01 64	
<b>Application info</b>	Mercedes-Benz BM 247 (GLB-Class) (08/19--)		

## Tie rod end

016 020 0076/HD

MTE0984HD

## Notes

Carbon Neutral  
Front Axle Left  
Front Axle Right

Length [mm]

175

Required quantity

2

Thread Size 1

M14x1,5

Thread Size 2

M16x1,5

reinforced version

replacement in pairs recommended



## References

Mercedes-Benz 223 460 14 01

Mercedes-Benz A 223 460 14 01

## Application info

Mercedes-Benz BM 223 (S-Class) (09/20--)

## Tie rod end

016 020 0077/HD

MTE0985HD

## Notes

Carbon Neutral  
Front Axle Left  
outer

Length [mm]

159

Paired article number

016 020 0078/HD | MTE0986HD

Required quantity

1

Thread Size 1

M14x1,5

Thread Size 2

M16x1,5

reinforced version

replacement in pairs recommended



## References

Mercedes-Benz 206 460 71 00

Mercedes-Benz A 206 460 71 00

Mercedes-Benz (BBDC) 206 460 71 00

Mercedes-Benz (BBDC) A 206 460 71 00

## Application info

Mercedes-Benz BM 206 (C-Class) (03/21--)

## Tie rod end

016 020 0078/HD

MTE0986HD

## Notes

Carbon Neutral  
 Front Axle Right  
 outer  
 Length [mm] 159  
 Paired article number 016 020 0077/HD | MTE0985HD  
 Required quantity 1  
 Thread Size 1 M14x1,5  
 Thread Size 2 M16x1,5  
 reinforced version  
 replacement in pairs recommended



## References

Mercedes-Benz 206 460 72 00  
 Mercedes-Benz (BBDC) 206 460 72 00

Mercedes-Benz A 206 460 72 00  
 Mercedes-Benz (BBDC) A 206 460 72 00

## Application info

Mercedes-Benz BM 206 (C-Class) (03/21--)

## Tie rod end

016 020 6330

MTE0037

## Notes

Front Axle Left  
 Front Axle Right  
 Length [mm] 72  
 Required quantity 2  
 Thread Size 1 M12x1,5  
 Thread Size 2 M12x1,5  
 replacement in pairs recommended



## References

Mercedes-Benz 000 330 74 35  
 Mercedes-Benz 001 330 77 35  
 Mercedes-Benz A 001 330 74 35

Mercedes-Benz 001 330 74 35  
 Mercedes-Benz A 000 330 74 35  
 Mercedes-Benz A 001 330 77 35

## Application info

Mercedes-Benz BM 170 (SLK) (04/96-04/04)  
 Mercedes-Benz BM 208 (CLK) (06/97-12/03)

Mercedes-Benz BM 202 (C-Class) (03/93-03/01)

## Tie rod end

016 020 6339

MTE0038

## Notes

Front Axle Left

Length [mm]

150

Paired article number

016 020 6340 | MTE0039

Required quantity

1

Thread Size 1

M14x1,5

Thread Size 2

M14x1,5

replacement in pairs recommended



## References

Mercedes-Benz 210 338 05 15

Mercedes-Benz A 210 338 05 15

## Application info

Mercedes-Benz BM 210 (E-Class) (06/95-08/03)

## Tie rod end

016 020 6340

MTE0039

## Notes

Front Axle Right

Length [mm]

150

Paired article number

016 020 6339 | MTE0038

Required quantity

1

Thread Size 1

M14x1,5

Thread Size 2

M14x1,5

replacement in pairs recommended



## References

Mercedes-Benz 210 338 06 15

Mercedes-Benz A 210 338 06 15

## Application info

Mercedes-Benz BM 210 (E-Class) (06/95-08/03)



## Tie rod end

016 030 0000

MTE0040

## Notes

Front Axle Left

Length [mm]

172

Paired article number

016 030 0002 | MTE0041

Required quantity

1

Thread Size 1

M14x1,5

Thread Size 2

M14x1,5

replacement in pairs recommended



## References

Mercedes-Benz 203 330 19 03

Mercedes-Benz 203 330 39 03

Mercedes-Benz A 203 330 19 03

Mercedes-Benz A 203 330 39 03

Mercedes-Benz (BBDC) 203 330 19 03

Mercedes-Benz (BBDC) 203 330 39 03

Mercedes-Benz (BBDC) A 203 330 19 03

Mercedes-Benz (BBDC) A 203 330 39 03

Mercedes-Benz 203 330 23 03

Mercedes-Benz 204 330 09 03

Mercedes-Benz A 203 330 23 03

Mercedes-Benz A 204 330 09 03

Mercedes-Benz (BBDC) 203 330 23 03

Mercedes-Benz (BBDC) 204 330 09 03

Mercedes-Benz (BBDC) A 203 330 23 03

Mercedes-Benz (BBDC) A 204 330 09 03

## Application info

Mercedes-Benz BM 171 (SLK) (03/04-12/11)

Mercedes-Benz BM 172 (SLK) (01/11--)

Mercedes-Benz BM 204 (C-Class) (01/07--)

Mercedes-Benz BM 209 (CLK) (05/02-03/10)

Mercedes-Benz BM 172 (SLC) (01/16--)

Mercedes-Benz BM 203 (C-Class) (05/00-06/11)

Mercedes-Benz BM 207 (E-Class) (01/09-12/16)

## Tie rod end

016 030 0002

MTE0041

## Notes

Front Axle Right

Length [mm]

172

Paired article number

016 030 0000 | MTE0040

Required quantity

1

Thread Size 1

M14x1,5

Thread Size 2

M14x1,5

replacement in pairs recommended



**References**

- |                                      |                                      |
|--------------------------------------|--------------------------------------|
| Mercedes-Benz 203 330 20 03          | Mercedes-Benz 203 330 24 03          |
| Mercedes-Benz 203 330 40 03          | Mercedes-Benz 204 330 10 03          |
| Mercedes-Benz A 203 330 20 03        | Mercedes-Benz A 203 330 24 03        |
| Mercedes-Benz A 203 330 40 03        | Mercedes-Benz A 204 330 10 03        |
| Mercedes-Benz (BBDC) 203 330 20 03   | Mercedes-Benz (BBDC) 203 330 24 03   |
| Mercedes-Benz (BBDC) 203 330 40 03   | Mercedes-Benz (BBDC) 204 330 10 03   |
| Mercedes-Benz (BBDC) A 203 330 20 03 | Mercedes-Benz (BBDC) A 203 330 24 03 |
| Mercedes-Benz (BBDC) A 203 330 40 03 | Mercedes-Benz (BBDC) A 204 330 10 03 |

**Application info**

- |  |  |
|--|--|
| Mercedes-Benz BM 171 (SLK) (03/04-12/11) | Mercedes-Benz BM 172 (SLC) (01/16--)         |
| Mercedes-Benz BM 172 (SLK) (01/11--)     | Mercedes-Benz BM 203 (C-Class) (05/00-06/11) |
| Mercedes-Benz BM 204 (C-Class) (01/07--) | Mercedes-Benz BM 207 (E-Class) (01/09-12/16) |
| Mercedes-Benz BM 209 (CLK) (05/02-03/10) |  |

**Tie rod end**

016 030 0006

MTE0042

**Notes**

- |                                  |                        |
|----------------------------------|------------------------|
|                                  | Front Axle Left        |
| Length [mm]                      | 184                    |
| Paired article number            | 016 030 0007   MTE0043 |
| Required quantity                | 1                      |
| Thread Size 1                    | M14x1,5                |
| Thread Size 2                    | M14x1,5                |
| replacement in pairs recommended |                        |



**References**

- |                                    |                                      |
|------------------------------------|--------------------------------------|
| Mercedes-Benz 211 330 01 03        | Mercedes-Benz 211 330 23 03          |
| Mercedes-Benz 211 330 25 03        | Mercedes-Benz 211 330 27 03          |
| Mercedes-Benz A 211 330 01 03      | Mercedes-Benz A 211 330 23 03        |
| Mercedes-Benz A 211 330 25 03      | Mercedes-Benz A 211 330 27 03        |
| Mercedes-Benz (BBDC) 211 330 27 03 | Mercedes-Benz (BBDC) A 211 330 27 03 |

**Application info**

- |  |  |
|--|--|
| Mercedes-Benz BM 211 (E-Class) (03/02-07/09) | Mercedes-Benz BM 219 (CLS) (10/04-02/11) |
|--|--|

## Tie rod end

016 030 0007

MTE0043

## Notes

Front Axle Right

Length [mm]

184

Paired article number

016 030 0006 | MTE0042

Required quantity

1

Thread Size 1

M14x1,5

Thread Size 2

M14x1,5

replacement in pairs recommended



## References

Mercedes-Benz 211 330 02 03

Mercedes-Benz 211 330 24 03

Mercedes-Benz 211 330 26 03

Mercedes-Benz 211 330 28 03

Mercedes-Benz A 211 330 02 03

Mercedes-Benz A 211 330 24 03

Mercedes-Benz A 211 330 26 03

Mercedes-Benz A 211 330 28 03

Mercedes-Benz (BBDC) 211 330 28 03

Mercedes-Benz (BBDC) A 211 330 28 03

## Application info

Mercedes-Benz BM 211 (E-Class) (03/02-07/09)

Mercedes-Benz BM 219 (CLS) (10/04-02/11)

## Tie rod end

036 020 0009

MTE0052

## Notes

Front Axle Left

Length [mm]

97

Paired article number

036 020 0010 | MTE0053

Required quantity

1

Thread Size 1

M14x1,5

Thread Size 2

M20x1,5

replacement in pairs recommended



## References

EVOBUS 601 330 04 35

Mercedes-Benz 601 330 04 35

Mercedes-Benz 601 330 06 35

Mercedes-Benz 601 330 53 35

Mercedes-Benz A 601 330 04 35

Mercedes-Benz A 601 330 06 35

Mercedes-Benz A 601 330 53 35

## Application info

Mercedes-Benz BM 460 (G-Class) (03/79-08/93)

Mercedes-Benz BM 461 (G-Class) (09/89--)

Mercedes-Benz BM 463 (G-Class) (09/89--)

Mercedes-Benz BM 601 / 602 (01/77-02/96)

Mercedes-Benz T2 (Vario) (08/96--)

## Tie rod end

036 020 0010

MTE0053

## Notes

Front Axle Right  
with left-hand thread

Length [mm] 97

Paired article number 036 020 0009 | MTE0052

Required quantity 1

Thread Size 1 M14x1,5

Thread Size 2 M20x1,5

replacement in pairs recommended



## References

EVOBUS 601 330 05 35

Mercedes-Benz 601 330 07 35

Mercedes-Benz A 601 330 05 35

Mercedes-Benz A 601 330 52 35

Mercedes-Benz 601 330 05 35

Mercedes-Benz 601 330 52 35

Mercedes-Benz A 601 330 07 35

## Application info

Mercedes-Benz BM 460 (G-Class) (03/79-08/93)

Mercedes-Benz BM 463 (G-Class) (09/89--)

Mercedes-Benz T2 (Vario) (08/96--)

Mercedes-Benz BM 461 (G-Class) (09/89--)

Mercedes-Benz BM 601 / 602 (01/77-02/96)

## Tie rod end

036 020 0011

MTE0054

## Notes

Front Axle Right  
with left-hand thread

Length [mm] 117

Paired article number 036 020 0012 | MTE0055

Required quantity 1

Thread Size 1 M14x1,5

Thread Size 2 M24x1,5

replacement in pairs recommended



## References

EVOBUS 602 330 57 35

Mercedes-Benz 602 330 54 35

Mercedes-Benz 608 330 55 35

Mercedes-Benz A 602 330 01 35

Mercedes-Benz A 602 330 57 35

Mercedes-Benz A 608 330 57 35

Mercedes-Benz 602 330 01 35

Mercedes-Benz 602 330 57 35

Mercedes-Benz 608 330 57 35

Mercedes-Benz A 602 330 54 35

Mercedes-Benz A 608 330 55 35

**Application info**

Mercedes-Benz BM 601 / 602 (01/77-02/96)

**Tie rod end****036 020 0012****MTE0055****Notes**

Front Axle Left

Length [mm]

117

Paired article number

036 020 0011 | MTE0054

Required quantity

1

Thread Size 1

M14x1,5

Thread Size 2

M24x1,5

replacement in pairs recommended

**References**

Mercedes-Benz 602 330 00 35

Mercedes-Benz 602 330 58 35

Mercedes-Benz A 602 330 55 35

Mercedes-Benz 602 330 55 35

Mercedes-Benz A 602 330 00 35

Mercedes-Benz A 602 330 58 35

**Application info**

Mercedes-Benz BM 601 / 602 (01/77-02/96)

**Tie rod end****036 020 0015****MTE0058****Notes**

Castellated Nut and Split Pin

Front Axle

with left-hand thread

Cone Size [mm]

20

Length [mm]

104

Paired article number

036 020 0016 | MTE0059

Required quantity

1

Thread Size 1

M24x1,5

Thread Size 2

M16x1,5

replacement in pairs recommended



**References**

- |                               |                               |
|-------------------------------|-------------------------------|
| Iveco 042480023               | Iveco 042532543               |
| Iveco 4248 0023               | Iveco 4253 2543               |
| Iveco 819 3649                | MAN 81.85301.0076             |
| MAN 81.95301.0078             | MAN 81.95301.6141             |
| MAN 81.95301.6304             | Mercedes-Benz 000 330 02 35   |
| Mercedes-Benz 000 330 07 35   | Mercedes-Benz 000 330 68 35   |
| Mercedes-Benz 000 330 86 35   | Mercedes-Benz 000 330 88 35   |
| Mercedes-Benz 000 460 73 48   | Mercedes-Benz 002 460 19 48   |
| Mercedes-Benz A 000 330 02 35 | Mercedes-Benz A 000 330 07 35 |
| Mercedes-Benz A 000 330 68 35 | Mercedes-Benz A 000 330 86 35 |
| Mercedes-Benz A 000 330 88 35 | Mercedes-Benz A 000 460 73 48 |
| Mercedes-Benz A 002 460 19 48 | R.V.I. 50 00 807 553          |
| R.V.I. 50 00 814 096          | R.V.I. 50 01 844 135          |
| R.V.I. 50 01 858 756          | R.V.I. 50 01 860 769          |
| Volvo 1517448                 |                               |

**Application info**

- |  |                                    |
|--|------------------------------------|
| Iveco MK (01/83-12/91)                   | MAN G (10/79-08/88)                |
| MAN G 90 (09/87-05/95)                   | MAN L 2000 (06/93--)               |
| MAN TGA (03/00--)                        | Mercedes-Benz ATEGO (01/98-10/04)  |
| Mercedes-Benz BM 463 (G-Class) (09/89--) | Mercedes-Benz LK/LN2 (01/84-12/11) |
| Mercedes-Benz NG (08/73-03/98)           | R.V.I. Messenger (09/90-06/99)     |
| Volvo F 4 (09/75-02/86)                  |                                    |

**Tie rod end**

036 020 0016

MTE0059

**Notes**

- |                                  |                               |
|----------------------------------|-------------------------------|
|                                  | Castellated Nut and Split Pin |
|                                  | Front Axle                    |
|                                  | with right-hand thread        |
| Cone Size [mm]                   | 20                            |
| Length [mm]                      | 104                           |
| Paired article number            | 036 020 0015   MTE0058        |
| Required quantity                | 1                             |
| Thread Size 1                    | M24x1,5                       |
| Thread Size 2                    | M16x1,5                       |
| replacement in pairs recommended |                               |



**References**

Iveco 0 4248 0024	Iveco 0 4249 1937
Iveco 4248 0024	Iveco 4249 1937
MAN 81.95301.0077	MAN 81.95301.0388
MAN 81.95301.6134	MAN 81.95301.6142
MAN 81.95301.6303	MAN 81.95301.6321
Mercedes-Benz 000 330 03 35	Mercedes-Benz 000 330 06 35
Mercedes-Benz 000 330 24 10	Mercedes-Benz 000 330 67 35
Mercedes-Benz 000 330 85 35	Mercedes-Benz 000 330 87 35
Mercedes-Benz 000 338 24 10	Mercedes-Benz 000 460 72 48
Mercedes-Benz 000 463 32 29	Mercedes-Benz 002 460 16 48
Mercedes-Benz A 000 330 03 35	Mercedes-Benz A 000 330 06 35
Mercedes-Benz A 000 330 24 10	Mercedes-Benz A 000 330 67 35
Mercedes-Benz A 000 330 85 35	Mercedes-Benz A 000 330 87 35
Mercedes-Benz A 000 338 24 10	Mercedes-Benz A 000 460 72 48
Mercedes-Benz A 000 463 32 29	Mercedes-Benz A 002 460 16 48
R.V.I. 50 00 514 097	R.V.I. 50 00 807 554
R.V.I. 50 00 814 097	R.V.I. 50 01 844 136
R.V.I. 50 01 858 757	R.V.I. 50 01 860 770
Volvo 1190778	Volvo 1517449
Volvo 1518142	

**Application info**

Iveco MK (01/83-12/91)	MAN G (10/79-08/88)
MAN G 90 (09/87-05/95)	MAN L 2000 (06/93--)
MAN TGA (03/00--)	Mercedes-Benz ATEGO (01/98-10/04)
Mercedes-Benz BM 463 (G-Class) (09/89--)	Mercedes-Benz LK/LN2 (01/84-12/11)
Mercedes-Benz NG (08/73-03/98)	R.V.I. Messenger (09/90-06/99)
R.V.I. Midliner (10/82-01/00)	Volvo B 12 (01/91--)
Volvo F 10 (01/76-12/95)	Volvo F 12 (01/76-12/95)
Volvo F 4 (09/75-02/86)	

**Tie rod end**

**036 020 0018 MTE0060**

**Notes**

	Front Axle Left
	Front Axle Right
Length [mm]	76
Required quantity	2
Thread Size 1	M16x1,5
Thread Size 2	M16x1,5
replacement in pairs recommended	



**References**

Mercedes-Benz 901 460 00 48  
 Mercedes-Benz 901 460 02 05  
 Mercedes-Benz A 901 460 01 48  
 Volkswagen 2D0 422 803

Mercedes-Benz 901 460 01 48  
 Mercedes-Benz A 901 460 00 48  
 Mercedes-Benz A 901 460 02 05

**Application info**

Mercedes-Benz BM 901 / 902 (Sprinter I) (01/95-05/06)  
 Mercedes-Benz BM 904 (Sprinter I) (02/95-05/12)  
 Mercedes-Benz BM 909 (Sprinter) (09/13--)

Mercedes-Benz BM 903 (Sprinter I) (01/95-05/12)  
 Mercedes-Benz BM 905 (Sprinter I) (04/01--)  
 Volkswagen LT II (04/96-07/06)

**Tie rod end**

036 020 0023

MTE0063

**Notes**

Front Axle Left  
 Front Axle Right  
 Length [mm] 70  
 Required quantity 2  
 Thread Size 1 M14x1,5  
 Thread Size 2 M16x1,5

replacement in pairs recommended



**References**

Mercedes-Benz 638 460 00 48  
 Mercedes-Benz A 638 460 00 48

Mercedes-Benz 638 460 02 05  
 Mercedes-Benz A 638 460 02 05

**Application info**

Mercedes-Benz BM 638 (V-Class / Vito) (02/96-07/03)

**Tie rod end**

11-16 020 0003

MTE0074

**Notes**

Front Axle Right  
 Length [mm] 119  
 Paired article number 11-16 020 0004 | MTE0075  
 Required quantity 1  
 Thread Size 1 M10x1,25  
 Thread Size 2 M16x1,5

replacement in pairs recommended



**References**

Peugeot 3817.39



**Application info**

Peugeot 406 (08/95-02/05)

**Tie rod end**

11-16 020 0004

MTE0075

**Notes**

Front Axle Left

Length [mm]

120

Paired article number

11-16 020 0003 | MTE0074

Required quantity

1

Thread Size 1

M10x1,25

Thread Size 2

M16x1,5

replacement in pairs recommended

**References**

Peugeot 3817.40

**Application info**

Peugeot 406 (08/95-02/05)

**Tie rod end**

11-16 020 0008

MTE0078

**Notes**

Front Axle Right

Length [mm]

175

Paired article number

40-16 020 0002 | MTE0437

Required quantity

1

Thread Size 1

M10x1,25

Thread Size 2

M14x1,5

replacement in pairs recommended

**References**

Citroën 3817.56

Peugeot 3817.56

**Application info**

Citroën C2 / C3 I / Pluriel (02/02--)

Peugeot 1007 (04/05--)

## Tie rod end

11-16 020 0009

MTE0079

## Notes

Front Axle Left

Length [mm]

210

Paired article number

11-16 020 0010 | MTE0080

Required quantity

1

Thread Size 1

M10x1,25

Thread Size 2

M16x1,5

replacement in pairs recommended



## References

Citroën 16 086 522 80

Citroën 16 289 504 80

DS 16 289 504 80

Peugeot 16 28 950 480

Citroën 16 109 351 80

Citroën 3817.67

Peugeot 16 086 522 80

Peugeot 3817.67

## Application info

Citroën C Elyse (11/12--)

Citroën C4 Cactus (09/14--)

DS DS 3 (04/15-07/19)

Peugeot 207 (02/06--)

Peugeot 301 (11/12--)

Citroën C3 Picasso (02/09--)

Citroën DS3 (11/09-12/16)

Peugeot 2008 I (03/13--)

Peugeot 208 I (03/12--)

## Tie rod end

11-16 020 0010

MTE0080

## Notes

Front Axle Right

Length [mm]

210

Paired article number

11-16 020 0009 | MTE0079

Required quantity

1

Thread Size 1

M10x1,25

Thread Size 2

M16x1,5

replacement in pairs recommended



## References

Citroën 16 086 523 80

Citroën 16 289 503 80

DS 16 086 523 80

Peugeot 16 086 523 80

Peugeot 3817.68

Citroën 16 109 352 80

Citroën 3817.68

DS 16 289 503 80

Peugeot 16 28 950 380

**Application info**

Citroën C Elyse (11/12--)  
 Citroën C4 Cactus (09/14--)  
 DS DS 3 (04/15-07/19)  
 Peugeot 207 (02/06--)  
 Peugeot 301 (11/12--)

Citroën C3 Picasso (02/09--)  
 Citroën DS3 (11/09-12/16)  
 Peugeot 208 I (03/13--)  
 Peugeot 208 I (03/12--)

**Tie rod end****11-16 020 0011****MTE0081****Notes**

Front Axle Left  
 for vehicles with power steering

Length [mm] 230  
 Paired article number 11-16 020 0012 | MTE0082  
 Required quantity 1  
 Thread Size 1 M10x1,25  
 Thread Size 2 M16x1,5  
 replacement in pairs recommended

**References**

Citroën 3817.53

Citroën 3817.59

**Application info**

Citroën C5 I / C5 II (03/01--)

**Tie rod end****11-16 020 0012****MTE0082****Notes**

Front Axle Right  
 for vehicles with power steering

Length [mm] 230  
 Paired article number 11-16 020 0011 | MTE0081  
 Required quantity 1  
 Thread Size 1 M10x1,25  
 Thread Size 2 M16x1,5  
 replacement in pairs recommended



**References**

Citroën 3817.54

Citroën 3817.60

**Application info**

Citroën C5 I / C5 II (03/01--)

Tie rod end		11-16 020 0013	MTE0083
<b>Notes</b>  Length [mm] 241 Paired article number 11-16 020 0014   MTE0084 Required quantity 1 Thread Size 1 M12x1,5 Thread Size 2 M14x1,5 replacement in pairs recommended			
<b>References</b> Citroën 3817.66 Peugeot 3817.66			
<b>Application info</b> Citroën C6 (09/05-12/12) Peugeot 407 (02/04-- )			
Tie rod end		11-16 020 0014	MTE0084
<b>Notes</b>  Length [mm] 241 Paired article number 11-16 020 0013   MTE0083 Required quantity 1 Thread Size 1 M12x1,5 Thread Size 2 M14x1,5 replacement in pairs recommended			
<b>References</b> Citroën 3817.65 Peugeot 3817.65			
<b>Application info</b> Citroën C6 (09/05-12/12) Peugeot 407 (02/04-- )			

## Tie rod end

11-16 020 0015/HD

MTE0085HD

## Notes

Carbon Neutral

Front Axle Left

Length [mm]

209

Paired article number

11-16 020 0016/HD | MTE0086HD

Required quantity

1

Thread Size 1

M14x1,5

Thread Size 2

M16x1,5

reinforced version

replacement in pairs recommended



## References

Citroën 16 109 764 80

Citroën 3817.77

Fiat 77364253

Peugeot 16 10 976 480

Peugeot 3817.77

Citroën 3817.69

Fiat 1376346080

Opel 16 109 754 80

Peugeot 3817.69

## Application info

Citroën Jumper III (04/06--)

Opel Movano C (12/21--)

Vauxhall Movano Mk III (12/21--)

Fiat Ducato (250) (07/06--)

Peugeot Boxer III (09/05--)

## Tie rod end

11-16 020 0016/HD

MTE0086HD

## Notes

Carbon Neutral

Front Axle Right

Length [mm]

209

Paired article number

11-16 020 0015/HD | MTE0085HD

Required quantity

1

Thread Size 1

M14x1,5

Thread Size 2

M16x1,5

reinforced version

replacement in pairs recommended



## References

Citroën 16 109 763 80

Fiat 1376345080

Opel 16 109 763 80

Peugeot 3817.70

Citroën 3817.70

Fiat 77364009

Peugeot 16 109 763 80

**Application info**

Citroën Jumper III (04/06--)  
 Opel Movano C (12/21--)  
 Vauxhall Movano Mk III (12/21--)

Fiat Ducato (250) (07/06--)  
 Peugeot Boxer III (09/05--)

**Tie rod end****11-16 020 0017****MTE0087****Notes**

Front Axle Left

Length [mm] 162  
 Paired article number 11-16 020 0018 | MTE0088  
 Required quantity 1  
 Thread Size 1 M12x1,25  
 Thread Size 2 M12x1,25  
 replacement in pairs recommended

**References**

Citroën 3817.63  
 Toyota 45047-09125

Peugeot 3817.63

**Application info**

Citroën C1 (06/05-09/14)  
 Peugeot 107 (06/05-05/14)  
 Toyota Aygo I (02/05-05/14)

Citroën C1 II (04/14--)  
 Peugeot 108 (05/14--)  
 Toyota Aygo II (05/14--)

**Tie rod end****11-16 020 0018****MTE0088****Notes**

Front Axle Right

Length [mm] 162  
 Paired article number 11-16 020 0017 | MTE0087  
 Required quantity 1  
 Thread Size 1 M12x1,25  
 Thread Size 2 M12x1,25  
 replacement in pairs recommended

**References**

Citroën 3817.64  
 Toyota 45046-09295

Peugeot 3817.64

**Application info**

Citroën C1 (06/05-09/14)  
 Peugeot 107 (06/05-05/14)  
 Toyota Aygo I (02/05-05/14)

Citroën C1 II (04/14--)  
 Peugeot 108 (05/14--)  
 Toyota Aygo II (05/14--)

**Tie rod end****11-16 020 0019****MTE0089****Notes**

Front Axle Left  
 Front Axle Right

Length [mm] 77  
 Required quantity 2  
 Thread Size 1 M12x1,5  
 Thread Size 2 M14x1,5  
 replacement in pairs recommended

**References**

Citroën 16 109 418 80  
 Citroën 3817.A5  
 Fiat 9403817738  
 Peugeot 16 10 941 880  
 Peugeot 3817.A5

Citroën 3817.73  
 DS 3817 A5  
 Lancia 9403817738  
 Peugeot 3817.73  
 Toyota SU001A1015

**Application info**

Citroën C4 II / DS4 (02/09--)  
 Citroën DS5 (09/11-07/15)  
 DS DS 4 I (07/15-12/18)  
 Fiat Scudo II (270) (01/07--)  
 Lancia Phedra (09/02-11/10)  
 Peugeot 807 (06/02--)  
 Peugeot RCZ (03/10-12/15)

Citroën C8 (06/02--)  
 Citroën Jumpy II (01/07--)  
 DS DS 5 (04/15-12/18)  
 Fiat Ulysse II (179) (08/02-06/11)  
 Peugeot 308 I (09/07--)  
 Peugeot Expert II (01/07--)  
 Toyota Proace I (06/13-03/16)

**Tie rod end****11-16 020 0020****MTE0090****Notes**

Front Axle Left

Length [mm] 240  
 Paired article number 11-16 020 0021 | MTE0091  
 Required quantity 1  
 Thread Size 1 M10x1,25  
 Thread Size 2 M14x1,5  
 replacement in pairs recommended



**References**

Peugeot 3817.58

**Application info**

Peugeot 407 (02/04--)

**Tie rod end**

11-16 020 0021

MTE0091

**Notes**

Front Axle Right

Length [mm]

240

Paired article number

11-16 020 0020 | MTE0090

Required quantity

1

Thread Size 1

M10x1,25

Thread Size 2

M14x1,5

replacement in pairs recommended

**References**

Peugeot 3817.57

**Application info**

Peugeot 407 (02/04--)

**Tie rod end**

11-16 020 0022

MTE0092

**Notes**

Front Axle Left

Length [mm]

165

Paired article number

11-16 020 0023 | MTE0093

Required quantity

1

Thread Size 1

M10x1,5

Thread Size 2

M14X1,5

replacement in pairs recommended

**References**

Citroën 3817.76

DS 3817 89

Peugeot 3817.89

Citroën 3817.89

Peugeot 3817.76



**Application info**

Citroën Berlingo I (07/96-12/11)  
 Citroën C4 II / DS4 (02/09--)  
 Peugeot 3008 I (05/09-12/17)  
 Peugeot 5008 I (06/09-03/17)

Citroën Berlingo II (04/08--)  
 DS DS 4 I (07/15-12/18)  
 Peugeot 308 I (09/07--)  
 Peugeot Partner II (04/08--)

**Tie rod end****11-16 020 0023****MTE0093****Notes**

Front Axle Right

Length [mm] 165  
 Paired article number 11-16 020 0022 | MTE0092  
 Required quantity 1  
 Thread Size 1 M10x1,5  
 Thread Size 2 M14x1,5  
 replacement in pairs recommended

**References**

Citroën 3817.75  
 DS 3817 88  
 Peugeot 3817.88

Citroën 3817.88  
 Peugeot 3817.75

**Application info**

Citroën Berlingo I (07/96-12/11)  
 Citroën C4 II / DS4 (02/09--)  
 Peugeot 3008 I (05/09-12/17)  
 Peugeot 5008 I (06/09-03/17)

Citroën Berlingo II (04/08--)  
 DS DS 4 I (07/15-12/18)  
 Peugeot 308 I (09/07--)  
 Peugeot Partner II (04/08--)

**Tie rod end****11-16 020 0024****MTE0094****Notes**

Front Axle Left

Length [mm] 178  
 Paired article number 11-16 020 0025 | MTE0095  
 Required quantity 1  
 Thread Size 1 M10x1,25  
 Thread Size 2 M14x1,5  
 replacement in pairs recommended

**References**

Citroën 3817.92

DS 3817.92

**Application info**

Citroën C3 II (09/09--)  
DS DS 3 (04/15-07/19)

Citroën DS3 (11/09-12/16)

**Tie rod end****11-16 020 0025****MTE0095****Notes**

Length [mm] 178  
Paired article number 11-16 020 0024 | MTE0094  
Required quantity 1  
Thread Size 1 M10x1,25  
Thread Size 2 M14x1,5  
replacement in pairs recommended

Front Axle Right

**References**

Citroën 3817.91

DS 3817.91

**Application info**

Citroën C3 II (09/09--)  
DS DS 3 (04/15-07/19)

Citroën DS3 (11/09-12/16)

**Tie rod end****11-16 020 0028****MTE0098****Notes**

Length [mm] 120  
Paired article number 11-16 020 0029 | MTE0099  
Required quantity 1  
Thread Size 1 M10x1,25  
Thread Size 2 M16x1,5  
replacement in pairs recommended

Front Axle Left





**References**





Citroën 16 109 357 80

Citroën 3817.71

**Application info**

Citroën C4 I / Coupe / Grand Picasso / Picasso / Stufenheck  
(11/04--)

Tie rod end		11-16 020 0029	MTE0099
<b>Notes</b>  Front Axle Right Length [mm] 120 Paired article number 11-16 020 0028   MTE0098 Required quantity 1 Thread Size 1 M10x1,25 Thread Size 2 M16x1,5 replacement in pairs recommended		 	
<b>References</b> Citroën 3817.72			
<b>Application info</b> Citroën C4 I / Coupe / Grand Picasso / Picasso / Stufenheck (11/04-- )			
Tie rod end		11-16 020 0032	MTE0102
<b>Notes</b>  Front Axle Left Front Axle Right Length [mm] 80 Required quantity 2 Thread Size 1 M10x1,25 Thread Size 2 M14x1,5 replacement in pairs recommended		 	
<b>References</b> Citroën 3817.94 DS 3817 94 Peugeot 3817.94			
<b>Application info</b> Citroën DS5 (09/11-07/15) DS DS 5 (04/15-12/18) Peugeot RCZ (03/10-12/15)			

Tie rod end		11-16 020 0033	MTE0540
<b>Notes</b>  Length [mm] 200 Paired article number 11-16 020 0034   MTE0541 Required quantity 1 Thread Size 1 M10x1,25 Thread Size 2 M14x1,5 replacement in pairs recommended		 	
<b>References</b> Citroën 16 08 025 280 Citroën 16 289 501 80 Peugeot 16 08 025 280 Peugeot 16 28 950 180			
<b>Application info</b> Citroën C4 Cactus (09/14--) Peugeot 208 I (03/12--) Peugeot 208 I (03/13--))			
Tie rod end		11-16 020 0034	MTE0541
<b>Notes</b>  Length [mm] 200 Paired article number 11-16 020 0033   MTE0540 Required quantity 1 Thread Size 1 M10x1,25 Thread Size 2 M14x1,5 replacement in pairs recommended		 	
<b>References</b> Citroën 16 08 025 180 Citroën 16 289 502 80 Peugeot 16 08 025 180 Peugeot 16 28 950 280			
<b>Application info</b> Citroën C4 Cactus (09/14--) Peugeot 208 I (03/12--) Peugeot 208 I (03/13--))			

## Tie rod end

11-16 020 0037/HD

MTE0759HD

## Notes

Carbon Neutral  
 Front Axle Left  
 Length [mm] 200  
 Paired article number 11-16 020 0038/HD | MTE0760HD  
 Required quantity 1  
 Thread Size 1 M12x1,5  
 Thread Size 2 M14x1,5  
 reinforced version  
 replacement in pairs recommended



## References

Peugeot 3817.A1

## Application info

Peugeot 508 I (11/10--)

## Tie rod end

11-16 020 0038/HD

MTE0760HD

## Notes

Carbon Neutral  
 Front Axle Right  
 Length [mm] 200  
 Paired article number 11-16 020 0037/HD | MTE0759HD  
 Required quantity 1  
 Thread Size 1 M12x1,5  
 Thread Size 2 M14x1,5  
 reinforced version  
 replacement in pairs recommended









## References

Peugeot 3817.A2

## Application info

Peugeot 508 I (11/10--)

Tie rod end		11-16 020 0041/HD	MTE0913HD
<b>Notes</b>			
	Carbon Neutral		
	Front Axle Left		
Length [mm]	185		
Paired article number	11-16 020 0042/HD   MTE0914HD		
Required quantity	1		
Thread Size 1	M12x1,5		
Thread Size 2	M14x1,5		
reinforced version			
replacement in pairs recommended			
<b>References</b>			
Citroën 98 203 400 80		Opel 98 203 400 80	
Peugeot 98 20 340 080		Toyota SU001-A7207	
<b>Application info</b>			
Citroën Jumpy III (04/16--)		Citroën Spacetourer (04/16--)	
Opel Vivaro C (03/19--)		Peugeot Expert III (04/16--)	
Peugeot Traveller (04/16--)		Toyota Proace II (02/16--)	
Vauxhall Vivaro C (03/19--)			
Tie rod end		11-16 020 0042/HD	MTE0914HD
<b>Notes</b>			
	Carbon Neutral		
	Front Axle Right		
Length [mm]	185		
Paired article number	11-16 020 0041/HD   MTE0913HD		
Required quantity	1		
Thread Size 1	M12x1,5		
Thread Size 2	M14x1,5		
reinforced version			
replacement in pairs recommended			
<b>References</b>			
Citroën 98 203 401 80		Opel 98 203 401 80	
Peugeot 98 20 340 180		Toyota SU001-A7208	
<b>Application info</b>			
Citroën Jumpy III (04/16--)		Citroën Spacetourer (04/16--)	
Opel Vivaro C (03/19--)		Peugeot Expert III (04/16--)	
Peugeot Traveller (04/16--)		Toyota Proace II (02/16--)	
Vauxhall Vivaro C (03/19--)			

Tie rod end		11-16 020 0043/HD	MTE0974HD
<b>Notes</b>  Carbon Neutral Front Axle Left Length [mm] 150 Paired article number 11-16 020 0044/HD   MTE0975HD Required quantity 1 Thread Size 1 M10x1,25 Thread Size 2 M14X1,5 reinforced version replacement in pairs recommended			
<b>References</b> Peugeot 16 73 314 480			
<b>Application info</b> Peugeot 2008 II (08/19-- )			
Tie rod end		11-16 020 0044/HD	MTE0975HD
<b>Notes</b>  Carbon Neutral Front Axle Right Length [mm] 150 Paired article number 11-16 020 0043/HD   MTE0974HD Required quantity 1 Thread Size 1 M10x1,25 Thread Size 2 M14X1,5 reinforced version replacement in pairs recommended			
<b>References</b> Peugeot 16 73 314 580			
<b>Application info</b> Peugeot 2008 II (08/19-- )			

## Tie rod end

11-16 020 0045/HD

MTE0964HD

## Notes

Carbon Neutral

Front Axle Left

Length [mm]

130

Paired article number

11-16 020 0046/HD | MTE0965HD

Required quantity

1

Thread Size 1

M10X1,25

Thread Size 2

M14X1,5

reinforced version

replacement in pairs recommended



## References

Opel 16 696 485 80

Peugeot 16 69 648 580

Vauxhall 16 696 485 80

## Application info

Opel Corsa F (07/19--)

Peugeot 208 II (06/19--)

Vauxhall Corsa Mk V (F) (07/19--)

## Tie rod end

11-16 020 0046/HD

MTE0965HD

## Notes

Carbon Neutral

Front Axle Right

Length [mm]

130

Paired article number

11-16 020 0045/HD | MTE0964HD

Required quantity

1

Thread Size 1

M10X1,25

Thread Size 2

M14X1,5

reinforced version

replacement in pairs recommended



## References

Opel 16 696 484 80

Peugeot 16 69 648 480

Vauxhall 16 696 484 80



## Application info



Opel Corsa F (07/19--)

Peugeot 208 II (06/19--)

Vauxhall Corsa Mk V (F) (07/19--)



Tie rod end		11-16 020 0047/HD	MTE0977HD
<p><b>Notes</b></p> <p>Carbon Neutral Front Axle Left outer</p> <p>Length [mm] 227</p> <p>Paired article number 11-16 020 0048/HD   MTE0978HD</p> <p>Required quantity 1</p> <p>Thread Size 1 M12x1,5</p> <p>Thread Size 2 M14x1,5</p> <p>reinforced version</p> <p>replacement in pairs recommended</p>			
<p><b>References</b></p> <p>DS 16 372 806 80</p>			
<p><b>Application info</b></p> <p>DS DS 7 (09/17--)</p> <p>Peugeot 508 II (09/18--)</p> <p>DS DS 9 (09/20--)</p>			
Tie rod end		11-16 020 0048/HD	MTE0978HD
<p><b>Notes</b></p> <p>Carbon Neutral Front Axle Right outer</p> <p>Length [mm] 227</p> <p>Paired article number 11-16 020 0047/HD   MTE0977HD</p> <p>Required quantity 1</p> <p>Thread Size 1 M12x1,5</p> <p>Thread Size 2 M14x1,5</p> <p>replacement in pairs recommended</p>			
<p><b>References</b></p> <p>DS 16 372 807 80</p> <p>Peugeot 16 372 807 80</p>			
<p><b>Application info</b></p> <p>DS DS 7 (09/17--)</p> <p>Peugeot 508 II (09/18--)</p> <p>DS DS 9 (09/20--)</p>			

Tie rod end		11-16 020 4078	MTE0103
<b>Notes</b>  Front Axle Left Front Axle Right  Length [mm] 78 Required quantity 2 Thread Size 1 M12x1,25 Thread Size 2 M16x1,5 replacement in pairs recommended			
<b>References</b> Citroën 97 500 799 80      Fiat 4336779 Fiat 9750079980      Peugeot 3817.11			
<b>Application info</b> Citroën C25 (07/81-07/94)      Fiat Ducato (280) (01/82-09/90) Fiat Ducato / Talento (290) (03/89-05/94)      Peugeot J5 (280) (09/81-09/90) Peugeot J5 (290) (09/90-03/94)			
Tie rod end		11-16 020 5042	MTE0104
<b>Notes</b>  Front Axle Left Front Axle Right  Length [mm] 75 Required quantity 2 Thread Size 1 M10x1,25 Thread Size 2 M14x1,5 replacement in pairs recommended			
<b>References</b> Citroën 4059.09      Citroën 94 040 590 80 Fiat 1306003080      Fiat 9404059080 Fiat 9404059098      Lancia 1306003080 Lancia 9404059080      Peugeot 4059.09			
<b>Application info</b> Citroën Evasion (03/94-10/02)      Citroën Jumpy I (06/94-12/06) Fiat Scudo I (220) (02/96-12/06)      Fiat Ulysse I (220) (06/94-08/02) Lancia Zeta (05/95-10/03)      Peugeot 806 (06/94-02/03) Peugeot Expert I (07/95-03/08)			

## Tie rod end

11-16 020 5703/HD

MTE0105HD

## Notes

Carbon Neutral  
Front Axle Left  
Front Axle Right

Length [mm]

91

Required quantity

2

Thread Size 1

M10x1,5

Thread Size 2

M14x1,5

reinforced version

replacement in pairs recommended



## References

CITROËN (DF-PSA) 3817.50

Citroën 3817.18

Citroën 3817.50

Peugeot 3817.18

Peugeot 3817.50

Peugeot 3817.52

Peugeot (DF-PSA) 3817.50

## Application info

Citroën Berlingo I (07/96-12/11)

Citroën C15 / Visa (09/78-10/06)

Citroën C4 I / Coupe / Grand Picasso / Picasso / Stufenheck  
(11/04--)

Citroën Xsara (04/97-03/10)

Citroën Xsara Picasso (09/99-06/12)

Citroën ZX (03/91-07/99)

Peugeot 205 (02/83-12/00)

Peugeot 306 (01/93-10/03)

Peugeot 307 (08/00-12/12)

Peugeot 309 (10/85-12/93)

Peugeot 505 (05/79-10/96)

Peugeot Partner I (05/96--)

Peugeot Partner II (04/08--)

## Tie rod end

11-16 020 7529

MTE0108

## Notes

Front Axle Left  
Front Axle Right

Length [mm]

119

Required quantity

2

Thread Size 1

M12x1,25

Thread Size 2

M16x1,5

replacement in pairs recommended



**References**

Citroën 16 073 209 80  
 Citroën 4018.H4  
 Fiat 1471655080  
 Peugeot 4018.A3

Citroën 4018.A3  
 Fiat 1306716080  
 Peugeot 16 07 320 980  
 Peugeot 4018.H4

**Application info**

Citroën Jumper I (02/94-08/02)  
 Fiat Ducato (230) (03/94-05/05)  
 Peugeot Boxer I (03/94-08/05)

Citroën Jumper II (02/02--)  
 Fiat Ducato (244) (04/02--)  
 Peugeot Boxer II (12/01--)

**Tie rod end****116 020 0000****MTE0109****Notes**

Length [mm] 94  
 Paired article number 116 020 0004 | MTE0112  
 Required quantity 1  
 Thread Size 1 M12x1,5  
 Thread Size 2 M14x1,5  
 replacement in pairs recommended

Front Axle Left

94

116 020 0004 | MTE0112

1

M12x1,5

M14x1,5

**References**

Audi 6R0 423 811 A  
 Seat 6Q0 423 811 C  
 Seat 6RD 423 811 B  
 Skoda 6Q0 423 811  
 Skoda 6R0 423 811  
 Skoda 6RD 423 811 B  
 Volkswagen 5Z0 423 811  
 Volkswagen 6Q0 419 813 C  
 Volkswagen 6Q0 423 811 A  
 Volkswagen 6Q0 423 811 D  
 Volkswagen 6R0 423 811 A  
 Volkswagen 6RD 423 811 A  
 Volkswagen (FAW) 6Q0 423 811 C  
 Volkswagen (SVW) 6R0 423 811

Seat 6Q0 423 811  
 Seat 6R0 423 811  
 Skoda 6Q0 419 811 C  
 Skoda 6Q0 423 811 C  
 Skoda 6R0 423 811 A  
 Skoda (SVW) 6R0 423 811  
 Volkswagen 6Q0 419 811 C  
 Volkswagen 6Q0 423 811  
 Volkswagen 6Q0 423 811 C  
 Volkswagen 6R0 423 811  
 Volkswagen 6RD 422 811  
 Volkswagen 6RD 423 811 B  
 Volkswagen (SVW) 6Q0 423 811 A

**Application info**

Audi A1 I (8X\_) (05/10-10/18)

Seat Ibiza IV (6J\_ ,6P\_) (03/08-12/18)

Skoda Fabia I (6Y\_) (08/99-03/08)

Skoda Rapid II (N\_) (07/12-12/19)

Volkswagen Fox/Lupo (Z51) (08/03--)

Volkswagen Polo (6R\_) (03/09--)

Volkswagen Polo Vivo (6S1, 6S3) (02/10-09/17)

Seat Ibiza III / Cordoba II (6L\_) (02/02-11/09)

Seat Toledo IV (KG3) (07/12-04/19)

Skoda Fabia II (54\_) (12/06-12/14)

Skoda Roomster (03/06-05/15)

Volkswagen Gol III (06/08--)

Volkswagen Polo (9N\_) (10/01--)

Volkswagen Polo Vivo (6R1, 6RS) (07/17--)

**Tie rod end****116 020 0002****MTE0110****Notes**

Front Axle Left  
for vehicles with power steering

Length [mm]

85

Manufacturer Restriction

ZF

Paired article number

116 020 0003 | MTE0111

Required quantity

1

Thread Size 1

M12x1,5

Thread Size 2

M16x1,5

replacement in pairs recommended

**References**

Audi 8N0 422 811 A

Seat 8N0 422 811 A

Volkswagen 8N0 422 811 A

**Application info**

Audi A3 I (8L\_) (09/96-09/06)

Audi TT I (8N\_) (10/98-12/06)

Seat Leon I / Toledo II (1M\_) (10/98-06/06)

Volkswagen Golf IV (1J1, 1J5) (08/97-06/14)

Volkswagen New Beetle (1Y7, 9C1, 1C1) (01/98-12/11)

**Tie rod end****116 020 0003****MTE0111****Notes**

Front Axle Right  
for vehicles with power steering

Length [mm]

85

Manufacturer Restriction

ZF

Paired article number

116 020 0002 | MTE0110

Required quantity

1

Thread Size 1

M12x1,5

Thread Size 2

M16x1,5

replacement in pairs recommended



**References**

Audi 8N0 422 812 A

Volkswagen 8N0 422 812 A

Seat 8N0 422 812 A

**Application info**

Audi A3 I (8L\_) (09/96-09/06)

Seat Leon I / Toledo II (1M\_) (10/98-06/06)

Volkswagen New Beetle (1Y7, 9C1, 1C1) (01/98-12/11)

Audi TT I (8N\_) (10/98-12/06)

Volkswagen Golf IV (1J1, 1J5) (08/97-06/14)

**Tie rod end****116 020 0004****MTE0112****Notes**

Front Axle Right

Length [mm]

94

Paired article number

116 020 0000 | MTE0109

Required quantity

1

Thread Size 1

M12x1,5

Thread Size 2

M14x1,5

replacement in pairs recommended

**References**

Audi 6R0 423 812 A

Seat 6Q0 423 812 C

Seat 6RD 422 812

Skoda 6Q0 419 812 C

Skoda 6Q0 423 812 C

Skoda 6RD 423 812 A

Skoda (SVW) 6R0 423 812

Volkswagen 6Q0 419 814 C

Volkswagen 6Q0 423 812 A

Volkswagen 6Q0 423 812 D

Volkswagen 6R0 423 812 A

Volkswagen 6RD 423 812 B

Volkswagen (SVW) 6Q0 423 812

Seat 6Q0 423 812

Seat 6R0 423 812

Seat 6RD 423 812 B

Skoda 6Q0 423 812

Skoda 6R0 423 812

Skoda 6RD 423 812 B

Volkswagen 6Q0 419 812 C

Volkswagen 6Q0 423 812

Volkswagen 6Q0 423 812 C

Volkswagen 6R0 423 812

Volkswagen 6RD 423 812 A

Volkswagen (FAW) 6Q0 423 812 C

Volkswagen (SVW) 6R0 423 812

**Application info**

Audi A1 I (8X\_) (05/10-10/18)

Seat Ibiza IV (6J\_ ,6P\_) (03/08-12/18)

Skoda Fabia I (6Y\_) (08/99-03/08)

Skoda Rapid II (N\_) (07/12-12/19)

Volkswagen Fox/Lupo (Z51) (08/03--)

Volkswagen Polo (6R\_) (03/09--)

Volkswagen Polo Vivo (6S1, 6S3) (02/10-09/17)

Seat Ibiza III / Cordoba II (6L\_) (02/02-11/09)

Seat Toledo IV (KG3) (07/12-04/19)

Skoda Fabia II (54\_) (12/06-12/14)

Skoda Roomster (03/06-05/15)

Volkswagen Gol III (06/08--)

Volkswagen Polo (9N\_) (10/01--)

Volkswagen Polo Vivo (6R1, 6RS) (07/17--)

## Tie rod end

116 020 0005

MTE0113

## Notes

Front Axle Left

Length [mm]	90
Paired article number	116 020 0006   MTE0114
Required quantity	1
Thread Size 1	M14x1,5
Thread Size 2	M16x1,5
replacement in pairs recommended	



## References

Audi 7L0 422 817 B	Audi 7L0 422 817 C
Audi 7L0 422 817 D	Porsche 955 347 131 20
Porsche 955 347 131 21	Porsche 955 347 131 22
Volkswagen 2H0 422 817	Volkswagen 7L0 422 817 B
Volkswagen 7L0 422 817 C	Volkswagen 7L0 422 817 D

## Application info

Audi Q7 I (4L_) (03/06-01/16)	Porsche Cayenne I (955) (09/02-12/10)
Porsche Cayenne II (92A) (06/10--)	Volkswagen Amarok I (09/10--)
Volkswagen Touareg I (7LA, 7L6, 7L7) (10/02-01/13)	Volkswagen Touareg II (7P5) (01/10-12/18)

## Tie rod end

116 020 0006

MTE0114

## Notes

Front Axle Right

Length [mm]	90
Paired article number	116 020 0005   MTE0113
Required quantity	1
Thread Size 1	M14x1,5
Thread Size 2	M16x1,5
replacement in pairs recommended	



## References

Audi 7L0 422 818 B	Audi 7L0 422 818 C
Audi 7L0 422 818 D	Porsche 955 347 132 20
Porsche 955 347 132 21	Porsche 955 347 132 22
Volkswagen 2H0 422 818	Volkswagen 7L0 422 818 B
Volkswagen 7L0 422 818 C	Volkswagen 7L0 422 818 D

**Application info**

Audi Q7 I (4L\_) (03/06-01/16)

Porsche Cayenne II (92A) (06/10--)

Volkswagen Touareg I (7LA, 7L6 ,7L7 ) (10/02-01/13)

Porsche Cayenne I (955) (09/02-12/10)

Volkswagen Amarok I (09/10--)

Volkswagen Touareg II (7P5 ) (01/10-12/18)

**Tie rod end****116 020 0008/HD****MTE0115HD****Notes**Carbon Neutral  
Front Axle Left  
Front Axle Right

Length [mm]

155

Required quantity

2

Thread Size 1

M8x1,25

Thread Size 2

M14x1,5

reinforced version

replacement in pairs recommended

**References**

Audi 4B0 419 811 G

Audi 4D0 419 811 J

Audi 4F0 419 811 C

Audi 4F0 498 811

Audi 4F0 498 811 C

Audi (FAW) 4F0 419 811 C

Audi (FAW) 4F0 498 811

Seat 4B0 419 811 G

Seat 4F0 419 811 A

Seat 4F0 498 811 C

Skoda 4F0 419 811 A

Skoda 4F0 419 811 D

Volkswagen 4F0 498 811

Volkswagen (SVW) 8E0 419 811

Audi 4B0 419 811 Q

Audi 4F0 419 811 A

Audi 4F0 419 811 D

Audi 4F0 498 811 A

Audi 8E0 419 811

Audi (FAW) 4F0 419 811 D

Audi (FAW) 4F0 498 811 A

Seat 4D0 419 811 J

Seat 4F0 419 811 D

Seat 8E0 419 811

Skoda 4F0 419 811 C

Skoda 4F0 498 811 A

Volkswagen 4F0 498 811 A

**Application info**

Audi A4 Cabriolet (8H\_) (01/02-12/09)

Audi A4 II (8E\_) (02/00-12/05)

Audi A6 II (4B, C5) (01/97-12/05)

Audi A8 I (4D\_) (03/94-12/05)

Seat Exeo (3R) (12/08-05/13)

Volkswagen Passat (3B\_) (08/96-12/05)

Audi A4 I (8D\_) (11/94-12/02)



Audi A4 III (8E\_) (11/04-06/08)



Audi A6 III (4F2, 4FH, 4F5) (04/04-08/11)

Audi Allroad (4BH) (05/00-08/05)

Skoda Superb I (3U) (12/01-03/08)



Tie rod end		116 020 0009	MTE0725
<b>Notes</b>			
	Front Axle Left		
Length [mm]	94		
Paired article number	116 020 0010   MTE0726		
Required quantity	1		
Thread Size 1	M12x1,5		
Thread Size 2 replacement in pairs recommended	M14x1,5		
<b>References</b>			
Audi 6C0 423 811 A		Seat 6C0 423 811 A	
Skoda 6C0 423 811 A		Volkswagen 6C0 423 811 A	
<b>Application info</b>			
Audi A1 I (8X_) (05/10-10/18)		Seat Ibiza IV (6J_ ,6P_) (03/08-12/18)	
Seat Toledo IV (KG3) (07/12-04/19)		Skoda Fabia III (NJ_) (08/14--)	
Skoda Rapid II (N_) (07/12-12/19)		Volkswagen Polo (6R_) (03/09--)	
Tie rod end		116 020 0010	MTE0726
<b>Notes</b>			
	Front Axle Right		
Length [mm]	94		
Paired article number	116 020 0009   MTE0725		
Required quantity	1		
Thread Size 1	M12x1,5		
Thread Size 2 replacement in pairs recommended	M14x1,5		
<b>References</b>			
Audi 6C0 423 812 A		Seat 6C0 423 812 A	
Skoda 6C0 423 812 A		Volkswagen 6C0 423 812 A	
<b>Application info</b>			
Audi A1 I (8X_) (05/10-10/18)		Seat Ibiza IV (6J_ ,6P_) (03/08-12/18)	
Seat Toledo IV (KG3) (07/12-04/19)		Skoda Fabia III (NJ_) (08/14--)	
Skoda Rapid II (N_) (07/12-12/19)		Volkswagen Polo (6R_) (03/09--)	

Tie rod end		116 020 0013	MTE0116
<b>Notes</b>  Rear Axle Left inner Length [mm] 106 Paired article number 116 020 0014   MTE0117 Required quantity 1 Thread Size 1 M14x1,5 Thread Size 2 M14x1,5 replacement in pairs recommended			
<b>References</b> Audi 443 505 365 D			
<b>Application info</b> Audi 100 (4A, C4) (12/90-11/94)      Audi 100/200 (44, 44Q, C3) (08/82-12/91) Audi A6 I (4A, C4) (06/94-12/97)      Audi V8 (D1) (10/88-02/94)			
Tie rod end		116 020 0014	MTE0117
<b>Notes</b>  Rear Axle Right inner Length [mm] 106 Paired article number 116 020 0013   MTE0116 Required quantity 1 Thread Size 1 M14x1,5 Thread Size 2 M14x1,5 replacement in pairs recommended			
<b>References</b> Audi 443 505 366 D			
<b>Application info</b> Audi 100 (4A, C4) (12/90-11/94)      Audi 100/200 (44, 44Q, C3) (08/82-12/91) Audi A6 I (4A, C4) (06/94-12/97)      Audi V8 (D1) (10/88-02/94)			

## Tie rod end

116 020 0020/HD

MTE0118HD

## Notes

Carbon Neutral  
Front Axle Left  
Front Axle Right

Length [mm] 160  
Required quantity 2  
Thread Size 1 M8x1,25  
Thread Size 2 M16x1,5  
reinforced version  
replacement in pairs recommended



## References

Audi 4E0 419 811 D  
Volkswagen 4E0 419 811 C  
Volkswagen 4E0 419 811 E

Audi 4E0 419 811 E  
Volkswagen 4E0 419 811 D

## Application info

Audi A8 II (4E\_) (10/02-12/10)

Volkswagen Phaeton (3D) (04/02-03/16)

## Tie rod end

116 020 0021

MTE0119

## Notes

Front Axle Right

Length [mm] 234  
Paired article number 116 020 0022 | MTE0120  
Required quantity 1  
Thread Size 1 M14x1,5  
Thread Size 2 M16x1,5  
replacement in pairs recommended



## References



Volkswagen 7E0 422 818  
Volkswagen 7H0 422 818 B  
Volkswagen 7H0 422 818 D

Volkswagen 7H0 422 818 A  
Volkswagen 7H0 422 818 C

## Application info

Volkswagen Transporter V (04/03-08/15)

Volkswagen Transporter VI (04/15--)

Tie rod end		116 020 0022	MTE0120
<b>Notes</b>  Paired article number Required quantity Thread Size 1 Thread Size 2 replacement in pairs recommended		Front Axle Left 116 020 0021   MTE0119 1 M14x1,5 M16x1,5	
			
<b>References</b> Volkswagen 7E0 422 817 Volkswagen 7H0 422 817 B Volkswagen 7H0 422 817 D Volkswagen 7H0 422 817 A Volkswagen 7H0 422 817 C			
<b>Application info</b> Volkswagen Transporter V (04/03-08/15) Volkswagen Transporter VI (04/15--)			
Tie rod end		116 020 0025/HD	MTE0121HD
<b>Notes</b>  Length [mm] Paired article number Required quantity Thread Size 1 Thread Size 2 reinforced version replacement in pairs recommended		Carbon Neutral Front Axle Left 94 116 020 0026/HD   MTE0122HD 1 M12x1,5 M16x1,5	
			

**References**

Audi 1K0 423 811 A  
 Audi 1K0 423 811 J  
 Audi (FAW) 1K0 423 811 K  
 Seat 1K0 423 811 E  
 Seat 1K0 423 811 K  
 Skoda 1K0 423 811 J  
 Skoda (SVW) 1K0 423 811 G  
 Volkswagen 1K0 423 811 A  
 Volkswagen 1K0 423 811 E  
 Volkswagen 1K0 423 811 J  
 Volkswagen (FAW) 1K0 423 811 E  
 Volkswagen (SVW) 1K0 423 811 G  
 Audi 1K0 423 811 E  
 Audi 1K0 423 811 K  
 CUPRA 1K0423811J  
 Seat 1K0 423 811 J  
 Skoda 1K0 423 811 E  
 Skoda 1K0 423 811 K  
 Skoda (SVW) 1K0 423 811 K  
 Volkswagen 1K0 423 811 C  
 Volkswagen 1K0 423 811 G  
 Volkswagen 1K0 423 811 K  
 Volkswagen (FAW) 1K0 423 811 G

**Application info**

Audi A3 II (8P\_) (05/03-12/15)  
 Audi A3 IV (8Y\_) (11/19--)  
 Audi Q3 I (8U\_) (06/11-12/18)  
 CUPRA ATECA (KH7\_KHP) (09/18--)  
 Seat Ateca (04/16--)  
 Seat Leon III (5F\_) (09/12--)  
 Seat Tarraco (09/18--)  
 Skoda Kodiaq I (10/16--)  
 Skoda Octavia III (5E\_) (11/12--)  
 Skoda Superb I (3U) (12/01-03/08)  
 Skoda Superb III (3V\_) (03/15--)  
 Volkswagen Arteon (03/17--)  
 Volkswagen CC (11/11-12/16)  
 Volkswagen Caddy IV (SA\_) (05/15--)  
 Volkswagen Golf V (1K1, 1K5, 5M1) (10/03-08/14)  
 Volkswagen Golf VII (5G1,BA5) (08/12--)  
 Volkswagen Jetta III (1K2) (09/04-12/13)  
 Volkswagen Jetta VII (BU3) (12/17--)  
 Volkswagen Passat (3C\_) (03/05-01/12)  
 Volkswagen Polo (AW1) (06/17--)  
 Volkswagen Sharan (7N) (05/10--)  
 Volkswagen Taos (CL1, CQ1) (10/20--)  
 Volkswagen Tiguan II (AD1, BW2) (01/16--)  
 Volkswagen Touran II (5T1) (05/15--)  
 Audi A3 III (8V\_) (04/12--)  
 Audi Q2 (06/16--)  
 Audi Q3 II (F3\_) (07/18--)  
 Seat Alhambra II (710) (06/10--)  
 Seat Leon II / Toledo III / Altea (1P\_,5P\_) (03/04--)  
 Seat Leon IV (KL\_) (11/19--)  
 Skoda Karoq (07/17--)  
 Skoda Octavia II (1Z\_) (02/04-06/13)  
 Skoda Octavia IV (NX\_) (11/19--)  
 Skoda Superb II (3T) (03/08-05/15)  
 Skoda Yeti (5L) (05/09-12/17)  
 Volkswagen Beetle (5C1) (04/11-07/19)  
 Volkswagen Caddy III (2KA, 2KB) (03/04-05/15)  
 Volkswagen Eos (03/06-08/15)  
 Volkswagen Golf VI (5K1, 517, AJ5) (10/08-05/16)  
 Volkswagen Golf VIII (CB1) (07/19--)  
 Volkswagen Jetta IV (162) (01/08--)  
 Volkswagen Passat (362, 365) (08/10-12/15)  
 Volkswagen Passat (B8) (08/14--)  
 Volkswagen Scirocco III (137) (05/08-11/17)  
 Volkswagen T-Roc (A11) (07/17--)  
 Volkswagen Tiguan I (5N) (09/07-07/18)  
 Volkswagen Touran I (1T1/2/3) (02/03-05/15)

## Tie rod end

116 020 0025

MTE0121

## Notes

	Front Axle Left
Length [mm]	94
Paired article number	116 020 0026   MTE0122
Required quantity	1
Thread Size 1	M12x1,5
Thread Size 2	M16x1,5
replacement in pairs recommended	



## References

Audi 1K0 423 811 A	Audi 1K0 423 811 E
Audi 1K0 423 811 J	Audi 1K0 423 811 K
Audi (FAW) 1K0 423 811 K	CUPRA 1K0423811J
Seat 1K0 423 811 E	Seat 1K0 423 811 J
Seat 1K0 423 811 K	Skoda 1K0 423 811 E
Skoda 1K0 423 811 J	Skoda 1K0 423 811 K
Skoda (SVW) 1K0 423 811 G	Skoda (SVW) 1K0 423 811 K
Volkswagen 1K0 423 811 A	Volkswagen 1K0 423 811 C
Volkswagen 1K0 423 811 E	Volkswagen 1K0 423 811 G
Volkswagen 1K0 423 811 J	Volkswagen 1K0 423 811 K
Volkswagen (FAW) 1K0 423 811 E	Volkswagen (FAW) 1K0 423 811 G
Volkswagen (SVW) 1K0 423 811 G	

**Application info**

- Audi A3 II (8P\_) (05/03-12/15)
- Audi A3 IV (8Y\_) (11/19--)
- Audi Q3 I (8U\_) (06/11-12/18)
- CUPRA ATECA (KH7\_KHP) (09/18--)
- Seat Ateca (04/16--)
- Seat Leon III (5F\_) (09/12--)
- Seat Tarraco (09/18--)
- Skoda Kodiaq I (10/16--)
- Skoda Octavia III (5E\_) (11/12--)
- Skoda Superb I (3U) (12/01-03/08)
- Skoda Superb III (3V\_) (03/15--)
- Volkswagen Arteon (03/17--)
- Volkswagen CC (11/11-12/16)
- Volkswagen Caddy IV (SA\_) (05/15--)
- Volkswagen Golf V (1K1, 1K5, 5M1) (10/03-08/14)
- Volkswagen Golf VII (5G1,BA5) (08/12--)
- Volkswagen Jetta III (1K2) (09/04-12/13)
- Volkswagen Jetta VII (BU3) (12/17--)
- Volkswagen Passat (3C\_) (03/05-01/12)
- Volkswagen Polo (AW1) (06/17--)
- Volkswagen Sharan (7N) (05/10--)
- Volkswagen Taos (CL1, CQ1) (10/20--)
- Volkswagen Tiguan II (AD1, BW2) (01/16--)
- Volkswagen Touran II (5T1) (05/15--)
- Audi A3 III (8V\_) (04/12--)
- Audi Q2 (06/16--)
- Audi Q3 II (F3\_) (07/18--)
- Seat Alhambra II (710) (06/10--)
- Seat Leon II / Toledo III / Altea (1P\_,5P\_) (03/04--)
- Seat Leon IV (KL\_) (11/19--)
- Skoda Karoq (07/17--)
- Skoda Octavia II (1Z\_) (02/04-06/13)
- Skoda Octavia IV (NX\_) (11/19--)
- Skoda Superb II (3T) (03/08-05/15)
- Skoda Yeti (5L) (05/09-12/17)
- Volkswagen Beetle (5C1) (04/11-07/19)
- Volkswagen Caddy III (2KA, 2KB) (03/04-05/15)
- Volkswagen Eos (03/06-08/15)
- Volkswagen Golf VI (5K1, 517, AJ5) (10/08-05/16)
- Volkswagen Golf VIII (CB1) (07/19--)
- Volkswagen Jetta IV (162) (01/08--)
- Volkswagen Passat (362, 365) (08/10-12/15)
- Volkswagen Passat (B8) (08/14--)
- Volkswagen Scirocco III (137) (05/08-11/17)
- Volkswagen T-Roc (A11) (07/17--)
- Volkswagen Tiguan I (5N) (09/07-07/18)
- Volkswagen Touran I (1T1/2/3) (02/03-05/15)

**Tie rod end**

**116 020 0026**

**MTE0122**

**Notes**

Front Axle Right  
 Length [mm] 94  
 Paired article number 116 020 0025 | MTE0121  
 Required quantity 1  
 Thread Size 1 M12x1,5  
 Thread Size 2 M16x1,5

replacement in pairs recommended



**References**

Audi 1K0 423 812 E  
 Audi 1K0 423 812 K  
 Seat 1K0 423 812 E  
 Seat 1K0 423 812 K  
 Skoda 1K0 423 812 J  
 Skoda (SVW) 1K0 423 812 G  
 Volkswagen 1K0 423 812 A  
 Volkswagen 1K0 423 812 E  
 Volkswagen 1K0 423 812 J  
 Volkswagen (FAW) 1K0 423 812 E  
 Volkswagen (SVW) 1K0 423 812 G  
 Audi 1K0 423 812 J  
 Audi (FAW) 1K0 423 812 K  
 Seat 1K0 423 812 J  
 Skoda 1K0 423 812 E  
 Skoda 1K0 423 812 K  
 Skoda (SVW) 1K0 423 812 G  
 Volkswagen 1K0 423 812 C  
 Volkswagen 1K0 423 812 G  
 Volkswagen 1K0 423 812 K  
 Volkswagen (FAW) 1K0 423 812 G

**Application info**

Audi A3 II (8P\_) (05/03-12/15)  
 Audi A3 IV (8Y\_) (11/19--)  
 Audi Q3 I (8U\_) (06/11-12/18)  
 CUPRA ATECA (KH7\_KHP) (09/18--)  
 Seat Ateca (04/16--)  
 Seat Leon III (5F\_) (09/12--)  
 Seat Tarraco (09/18--)  
 Skoda Kodiaq I (10/16--)  
 Skoda Octavia III (5E\_) (11/12--)  
 Skoda Superb I (3U) (12/01-03/08)  
 Skoda Superb III (3V\_) (03/15--)  
 Volkswagen Arteon (03/17--)  
 Volkswagen CC (11/11-12/16)  
 Volkswagen Caddy IV (SA\_) (05/15--)  
 Volkswagen Golf V (1K1, 1K5, 5M1) (10/03-08/14)  
 Volkswagen Golf VII (5G1,BA5) (08/12--)  
 Volkswagen Jetta III (1K2) (09/04-12/13)  
 Volkswagen Jetta VII (BU3) (12/17--)  
 Volkswagen Passat (3C\_) (03/05-01/12)  
 Volkswagen Polo (AW1) (06/17--)  
 Volkswagen Sharan (7N) (05/10--)  
 Volkswagen Taos (CL1, CQ1) (10/20--)  
 Volkswagen Tiguan II (AD1, BW2) (01/16--)  
 Volkswagen Touran II (5T1) (05/15--)  
 Audi A3 III (8V\_) (04/12--)  
 Audi Q2 (06/16--)  
 Audi Q3 II (F3\_) (07/18--)  
 Seat Alhambra II (710) (06/10--)  
 Seat Leon II / Toledo III / Altea (1P\_,5P\_) (03/04--)  
 Seat Leon IV (KL\_) (11/19--)  
 Skoda Karoq (07/17--)  
 Skoda Octavia II (1Z\_) (02/04-06/13)  
 Skoda Octavia IV (NX\_) (11/19--)  
 Skoda Superb II (3T) (03/08-05/15)  
 Skoda Yeti (5L) (05/09-12/17)  
 Volkswagen Beetle (5C1) (04/11-07/19)  
 Volkswagen Caddy III (2KA, 2KB) (03/04-05/15)  
 Volkswagen Eos (03/06-08/15)  
 Volkswagen Golf VI (5K1, 517, AJ5) (10/08-05/16)  
 Volkswagen Golf VIII (CB1) (07/19--)  
 Volkswagen Jetta IV (162) (01/08--)  
 Volkswagen Passat (362, 365) (08/10-12/15)  
 Volkswagen Passat (B8) (08/14--)  
 Volkswagen Scirocco III (137) (05/08-11/17)  
 Volkswagen T-Roc (A11) (07/17--)  
 Volkswagen Tiguan I (5N) (09/07-07/18)  
 Volkswagen Touran I (1T1/2/3) (02/03-05/15)



## Tie rod end

116 020 0026/HD

MTE0122HD

## Notes

Carbon Neutral  
 Front Axle Right  
 Length [mm] 94  
 Paired article number 116 020 0025/HD | MTE0121HD  
 Required quantity 1  
 Thread Size 1 M12x1,5  
 Thread Size 2 M16x1,5  
 reinforced version  
 replacement in pairs recommended



## References

Audi 1K0 423 812 E	Audi 1K0 423 812 J
Audi 1K0 423 812 K	Audi (FAW) 1K0 423 812 K
Seat 1K0 423 812 E	Seat 1K0 423 812 J
Seat 1K0 423 812 K	Skoda 1K0 423 812 E
Skoda 1K0 423 812 J	Skoda 1K0 423 812 K
Skoda (SVW) 1K0 423 812 G	Skoda (SVW) 1K0 423 812 K
Volkswagen 1K0 423 812 A	Volkswagen 1K0 423 812 C
Volkswagen 1K0 423 812 E	Volkswagen 1K0 423 812 G
Volkswagen 1K0 423 812 J	Volkswagen 1K0 423 812 K
Volkswagen (FAW) 1K0 423 812 E	Volkswagen (FAW) 1K0 423 812 G
Volkswagen (SVW) 1K0 423 812 G	

**Application info**

- Audi A3 II (8P\_) (05/03-12/15)
- Audi A3 IV (8Y\_) (11/19--)
- Audi Q3 I (8U\_) (06/11-12/18)
- CUPRA ATECA (KH7\_KHP) (09/18--)
- Seat Ateca (04/16--)
- Seat Leon III (5F\_) (09/12--)
- Seat Tarraco (09/18--)
- Skoda Kodiaq I (10/16--)
- Skoda Octavia III (5E\_) (11/12--)
- Skoda Superb I (3U) (12/01-03/08)
- Skoda Superb III (3V\_) (03/15--)
- Volkswagen Arteon (03/17--)
- Volkswagen CC (11/11-12/16)
- Volkswagen Caddy IV (SA\_) (05/15--)
- Volkswagen Golf V (1K1, 1K5, 5M1) (10/03-08/14)
- Volkswagen Golf VII (5G1,BA5) (08/12--)
- Volkswagen Jetta III (1K2) (09/04-12/13)
- Volkswagen Jetta VII (BU3) (12/17--)
- Volkswagen Passat (3C\_) (03/05-01/12)
- Volkswagen Polo (AW1) (06/17--)
- Volkswagen Sharan (7N) (05/10--)
- Volkswagen Taos (CL1, CQ1) (10/20--)
- Volkswagen Tiguan II (AD1, BW2) (01/16--)
- Volkswagen Touran II (5T1) (05/15--)
- Audi A3 III (8V\_) (04/12--)
- Audi Q2 (06/16--)
- Audi Q3 II (F3\_) (07/18--)
- Seat Alhambra II (710) (06/10--)
- Seat Leon II / Toledo III / Altea (1P\_ ,5P\_) (03/04--)
- Seat Leon IV (KL\_) (11/19--)
- Skoda Karoq (07/17--)
- Skoda Octavia II (1Z\_) (02/04-06/13)
- Skoda Octavia IV (NX\_) (11/19--)
- Skoda Superb II (3T) (03/08-05/15)
- Skoda Yeti (5L) (05/09-12/17)
- Volkswagen Beetle (5C1) (04/11-07/19)
- Volkswagen Caddy III (2KA, 2KB) (03/04-05/15)
- Volkswagen Eos (03/06-08/15)
- Volkswagen Golf VI (5K1, 517, AJ5) (10/08-05/16)
- Volkswagen Golf VIII (CB1) (07/19--)
- Volkswagen Jetta IV (162) (01/08--)
- Volkswagen Passat (362, 365) (08/10-12/15)
- Volkswagen Passat (B8) (08/14--)
- Volkswagen Scirocco III (137) (05/08-11/17)
- Volkswagen T-Roc (A11) (07/17--)
- Volkswagen Tiguan I (5N) (09/07-07/18)
- Volkswagen Touran I (1T1/2/3) (02/03-05/15)

**Tie rod end**

116 020 0029/HD

MTE0125HD

**Notes**

Carbon Neutral  
 Front Axle Right  
 Length [mm] 206  
 Paired article number 116 020 0030/HD | MTE0126HD  
 Required quantity 1  
 Thread Size 1 M12x1,5  
 Thread Size 2 M16x1,5  
 reinforced version  
 replacement in pairs recommended



**References**

- Audi 4G0 423 812 A
- Audi 8K0 422 818 B
- Audi (FAW) 8K0 422 818 B
- Volkswagen (SVW) 4G0 423 812 A
- Audi 8K0 422 818 A
- Audi (FAW) 8K0 422 818 A
- Porsche 4G0 423 812 A

**Application info**

Audi A4 IV (8K\_) (08/07-05/16)

Audi A6 IV (4G2, 4G5, C7) (11/10-09/18)

Audi Q5 I (8R\_) (11/08-12/17)

Audi A5 I (8F\_ , 8T\_) (06/07-01/17)

Audi A7 I Sportback (4G\_) (07/10-05/18)

Porsche Macan (95B) (02/14--)

**Tie rod end****116 020 0030/HD****MTE0126HD****Notes**

Carbon Neutral

Front Axle Left

Length [mm]

206

Paired article number

116 020 0029/HD | MTE0125HD

Required quantity

1

Thread Size 1

M12x1,5

Thread Size 2

M16x1,5

reinforced version

replacement in pairs recommended

**References**

Audi 4G0 423 811 A

Audi 8K0 422 817 B

Audi (FAW) 8K0 422 817 B

Volkswagen (SVW) 4G0 423 811 A

Audi 8K0 422 817 A

Audi (FAW) 8K0 422 817 A

Porsche 4G0 423 811 A

**Application info**

Audi A4 IV (8K\_) (08/07-05/16)

Audi A6 IV (4G2, 4G5, C7) (11/10-09/18)

Audi Q5 I (8R\_) (11/08-12/17)

Audi A5 I (8F\_ , 8T\_) (06/07-01/17)

Audi A7 I Sportback (4G\_) (07/10-05/18)

Porsche Macan (95B) (02/14--)

**Tie rod end****116 020 0031****MTE0127****Notes**

Front Axle Left

Length [mm]

200

Paired article number

116 020 0032 | MTE0128

Required quantity

1

Thread Size 1

M12x1,5

Thread Size 2

M16x1,5

replacement in pairs recommended

**References**

Audi 8J0 423 811

**Application info**

Audi TT II (8J\_) (07/06-01/15)

**Tie rod end**

116 020 0032

MTE0128

**Notes**

Front Axle Right

Length [mm]

200

Paired article number

116 020 0031 | MTE0127

Required quantity

1

Thread Size 1

M12x1,5

Thread Size 2

M16x1,5

replacement in pairs recommended

**References**

Audi 8J0 423 812

**Application info**

Audi TT II (8J\_) (07/06-01/15)

**Tie rod end**

116 020 0035

MTE0131

**Notes**

Front Axle Left

Length [mm]

94

Paired article number

116 020 0036 | MTE0132

Required quantity

1

Thread Size 1

M12x1,5

Thread Size 2

M14x1,5

replacement in pairs recommended

**References**

Audi 1S0 423 811 A

Skoda 1S0 423 811 A

Seat 1S0 423 811 A

Volkswagen 1S0 423 811 A

**Application info**

Audi A1 I (8X\_) (05/10-10/18)

Skoda Citigo (10/11--)

Seat Mii (10/11--)

Volkswagen UP (08/11--)

## Tie rod end

116 020 0036

MTE0132

## Notes

	Front Axle Right
Length [mm]	94
Paired article number	116 020 0035   MTE0131
Required quantity	1
Thread Size 1	M12x1,5
Thread Size 2	M14x1,5
replacement in pairs recommended	



## References

Audi 1S0 423 812 A	Seat 1S0 423 812 A
Skoda 1S0 423 812 A	Volkswagen 1S0 423 812 A

## Application info

Audi A1 I (8X_) (05/10-10/18)	Seat Mii (10/11--)
Skoda Citigo (10/11--)	Volkswagen UP (08/11--)

## Tie rod end

116 020 0037

MTE0895

## Notes

	Front Axle Left
Length [mm]	211
Paired article number	116 020 0038   MTE0896
Required quantity	1
Thread Size 1	M14x1,5
Thread Size 2	M16x1,5
replacement in pairs recommended	





## References

Audi 4H0 422 817 A	Audi 4H0 423 811
--------------------	------------------

## Application info

Audi A8 III (4H_) (11/09-01/18)
---------------------------------

Tie rod end		116 020 0038	MTE0896
<b>Notes</b>  Front Axle Right Length [mm] 211 Paired article number 116 020 0037   MTE0895 Required quantity 1 Thread Size 1 M14x1,5 Thread Size 2 M16x1,5 replacement in pairs recommended			
<b>References</b> Audi 4H0 422 818 A Audi 4H0 423 812			
<b>Application info</b> Audi A8 III (4H_) (11/09-01/18)			
Tie rod end		116 020 0040/HD	MTE0721HD
<b>Notes</b>  Carbon Neutral Front Axle Right Length [mm] 94 Paired article number 116 020 0041/HD   MTE0722HD Required quantity 1 Thread Size 1 M12x1,5 Thread Size 2 M14x1,5 reinforced version replacement in pairs recommended			

**References**

Audi 6R0 423 812 A	Seat 6Q0 423 812
Seat 6Q0 423 812 C	Seat 6R0 423 812
Seat 6RD 423 812 B	Skoda 6Q0 419 812 C
Skoda 6Q0 423 812	Skoda 6Q0 423 812 C
Skoda 6R0 423 812	Skoda 6RD 423 812 A
Skoda 6RD 423 812 B	Skoda (SVW) 6R0 423 812
Volkswagen 6Q0 419 812 C	Volkswagen 6Q0 419 814 C
Volkswagen 6Q0 423 812	Volkswagen 6Q0 423 812 A
Volkswagen 6Q0 423 812 C	Volkswagen 6Q0 423 812 D
Volkswagen 6R0 423 812	Volkswagen 6R0 423 812 A
Volkswagen 6RD 422 812	Volkswagen 6RD 423 812 A
Volkswagen 6RD 423 812 B	Volkswagen (FAW) 6Q0 423 812 C
Volkswagen (SVW) 6Q0 423 812	Volkswagen (SVW) 6R0 423 812

**Application info**

Audi A1 I (8X_) (05/10-10/18)	Seat Ibiza III / Cordoba II (6L_) (02/02-11/09)
Seat Ibiza IV (6J_ ,6P_) (03/08-12/18)	Seat Toledo IV (KG3) (07/12-04/19)
Skoda Fabia I (6Y_) (08/99-03/08)	Skoda Fabia II (54_) (12/06-12/14)
Skoda Rapid II (N_) (07/12-12/19)	Skoda Roomster (03/06-05/15)
Volkswagen Fox/Lupo (Z51) (08/03--)	Volkswagen Polo (6R_) (03/09--)
Volkswagen Polo (9N_) (10/01--)	Volkswagen Polo Vivo (6S1, 6S3) (02/10-09/17)
Volkswagen Polo Vivo (6R1, 6RS) (07/17--)	

**Tie rod end****116 020 0041/HD****MTE0722HD****Notes**

Carbon Neutral  
Front Axle Left  
Length [mm] 94  
Paired article number 116 020 0040/HD | MTE0721HD  
Required quantity 1  
Thread Size 1 M12x1,5  
Thread Size 2 M14x1,5

reinforced version  
replacement in pairs recommended



**References**

Audi 6R0 423 811 A	Seat 6Q0 423 811
Seat 6Q0 423 811 C	Seat 6R0 423 811
Seat 6RD 423 811 B	Skoda 6Q0 419 811 C
Skoda 6Q0 423 811	Skoda 6Q0 423 811 C
Skoda 6R0 423 811	Skoda 6R0 423 811 A
Skoda 6RD 423 811 B	Skoda (SVW) 6R0 423 811
Volkswagen 6Q0 419 811 C	Volkswagen 6Q0 419 813 C
Volkswagen 6Q0 423 811	Volkswagen 6Q0 423 811 A
Volkswagen 6Q0 423 811 C	Volkswagen 6Q0 423 811 D
Volkswagen 6R0 423 811	Volkswagen 6R0 423 811 A
Volkswagen 6RD 422 811	Volkswagen 6RD 423 811 A
Volkswagen 6RD 423 811 B	Volkswagen (FAW) 6Q0 423 811 C
Volkswagen (SVW) 6Q0 423 811 A	Volkswagen (SVW) 6R0 423 811

**Application info**

Audi A1 I (8X_) (05/10-10/18)	Seat Ibiza III / Cordoba II (6L_) (02/02-11/09)
Seat Ibiza IV (6J_ ,6P_) (03/08-12/18)	Seat Toledo IV (KG3) (07/12-04/19)
Skoda Fabia I (6Y_) (08/99-03/08)	Skoda Fabia II (54_) (12/06-12/14)
Skoda Rapid II (N_) (07/12-12/19)	Skoda Roomster (03/06-05/15)
Volkswagen Fox/Lupo (Z51) (08/03--)	Volkswagen Polo (6R_) (03/09--)
Volkswagen Polo (9N_) (10/01--)	Volkswagen Polo Vivo (6S1, 6S3) (02/10-09/17)
Volkswagen Polo Vivo (6R1, 6RS) (07/17--)	

**Tie rod end****116 020 0046****MTE0734****Notes**

	Front Axle Left
	Front Axle Right
Length [mm]	155
Required quantity	2
Thread Size 1	M8x1,25
Thread Size 2	M14x1,5
replacement in pairs recommended	





**References**

Audi 4B0 419 811 G	Audi 4B0 419 811 Q
Audi 4D0 419 811 J	Audi 4F0 419 811 A
Audi 4F0 419 811 C	Audi 4F0 419 811 D
Audi 4F0 498 811	Audi 4F0 498 811 A
Audi 4F0 498 811 C	Audi 8E0 419 811
Audi (FAW) 4F0 419 811 C	Audi (FAW) 4F0 419 811 D
Audi (FAW) 4F0 498 811	Audi (FAW) 4F0 498 811 A
Seat 4B0 419 811 G	Seat 4D0 419 811 J
Seat 4F0 419 811 A	Seat 4F0 419 811 D
Seat 4F0 498 811 A	Seat 4F0 498 811 C
Seat 8E0 419 811	Skoda 4F0 419 811 A
Skoda 4F0 419 811 C	Skoda 4F0 419 811 D
Skoda 4F0 498 811 A	Volkswagen 4F0 419 811 E
Volkswagen 4F0 498 811	Volkswagen 4F0 498 811 A
Volkswagen (SVW) 4F0 419 811 C	Volkswagen (SVW) 4F0 419 811 E
Volkswagen (SVW) 4F0 498 811	Volkswagen (SVW) 4F0 498 811 A
Volkswagen (SVW) 8E0 419 811	

**Application info**

Audi A4 Cabriolet (8H_) (01/02-12/09)	Audi A4 I (8D_) (11/94-12/02)
Audi A4 II (8E_) (02/00-12/05)	Audi A4 III (8E_) (11/04-06/08)
Audi A6 II (4B, C5) (01/97-12/05)	Audi A6 III (4F2, 4FH, 4F5) (04/04-08/11)
Audi A8 I (4D_) (03/94-12/05)	Audi Allroad (4BH) (05/00-08/05)
Seat Exeo (3R) (12/08-05/13)	Skoda Superb I (3U) (12/01-03/08)
Volkswagen Passat (3B_) (08/96-12/05)	

**Tie rod end****116 020 0047****MTE0735****Notes**

Front Axle Left  
 Front Axle Right  
 Length [mm] 156  
 Required quantity 2  
 Thread Size 1 M8x1,25  
 Thread Size 2 M14x1,5

replacement in pairs recommended



**References**

Audi 4B0 419 811 F	Audi 8E0 419 811 B
Audi (FAW) 8E0 419 811 B	Skoda 8E0 419 811 B
Volkswagen 4B0 419 811 B	Volkswagen 4B0 419 811 E
Volkswagen 4B0 419 811 F	Volkswagen 4D0 419 811 A
Volkswagen 4D0 419 811 B	Volkswagen 8D0 498 998 A
Volkswagen 8E0 419 811 B	Volkswagen (SVW) 4B0 419 811 E
Volkswagen (SVW) 8E0 419 811 B	

**Application info**

Audi A4 Cabriolet (8H_) (01/02-12/09)	Audi A4 I (8D_) (11/94-12/02)
Audi A4 II (8E_) (02/00-12/05)	Audi A6 II (4B, C5) (01/97-12/05)
Audi A8 I (4D_) (03/94-12/05)	Audi Allroad (4BH) (05/00-08/05)
Skoda Superb I (3U) (12/01-03/08)	Volkswagen Passat (3B_) (08/96-12/05)

**Tie rod end****116 020 0048/HD****MTE0844HD****Notes**

Carbon Neutral	
Front Axle Right	
outer	
Length [mm]	202
Paired article number	116 020 0049/HD   MTE0845HD
Required quantity	1
Thread Size 1	M14x1,5
Thread Size 2	M16x1,5
reinforced version	
replacement in pairs recommended	

**References**

Audi 8S0 423 812 A

**Application info**

Audi TT III (8S\_) (07/14--)

## Tie rod end

116 020 0049/HD

MTE0845HD

## Notes

Carbon Neutral  
 Front Axle Left  
 outer  
 Length [mm] 202  
 Paired article number 116 020 0048/HD | MTE0844HD  
 Required quantity 1  
 Thread Size 1 M14x1,5  
 Thread Size 2 M16x1,5  
 reinforced version  
 replacement in pairs recommended



## References

Audi 8S0 423 811 A

## Application info

Audi TT III (8S\_) (07/14--)

## Tie rod end

116 020 0050/HD

MTE0840HD

## Notes

Carbon Neutral  
 Front Axle Right  
 outer  
 Length [mm] 219  
 Paired article number 116 020 0051/HD | MTE0841HD  
 Required quantity 1  
 Thread Size 1 M14x1,5  
 Thread Size 2 M16x1,5  
 reinforced version  
 replacement in pairs recommended



## References

Audi 4M0 423 812 B

Audi 4M0 423 812 D

Volkswagen 4M0 423 812 C

Audi 4M0 423 812 C

Volkswagen 4M0 423 812 B

Volkswagen 4M0 423 812 D

## Application info

Audi A8 IV (4N\_) (06/17--)



Audi Q7 II (4M\_) (01/15--)

Audi Q8 E-TRON (11/22--)

Audi E-TRON (GE\_) (09/18--)

Audi Q8 (4MN) (02/18--)

Volkswagen Touareg III (CR7) (11/17--)

Tie rod end		116 020 0051/HD	MTE0841HD
<b>Notes</b>  Carbon Neutral Front Axle Left outer  Length [mm] 219 Paired article number 116 020 0050/HD   MTE0840HD Required quantity 1 Thread Size 1 M14x1,5 Thread Size 2 M16x1,5 reinforced version replacement in pairs recommended			
<b>References</b> Audi 4M0 423 811 B Audi 4M0 423 811 C Audi 4M0 423 811 D Volkswagen 4M0 423 811 B Volkswagen 4M0 423 811 C Volkswagen 4M0 423 811 D			
<b>Application info</b> Audi A8 IV (4N_) (06/17--) Audi Q7 II (4M_) (01/15--) Audi Q8 E-TRON (11/22--) Audi E-TRON (GE_) (09/18--) Audi Q8 (4MN) (02/18--) Volkswagen Touareg III (CR7) (11/17--)			
Tie rod end		116 020 0052/HD	MTE0848HD
<b>Notes</b>  Carbon Neutral Front Axle Right outer  Length [mm] 207 Paired article number 116 020 0053/HD   MTE0849HD Required quantity 1 Thread Size 1 M14x1,5 Thread Size 2 M16x1,5 reinforced version replacement in pairs recommended			
<b>References</b> Audi 8W0 423 812 B Audi 8W0 423 812 C Audi (FAW) 8W0 423 812 B Audi (FAW) 8W0 423 812 C			

**Application info**

Audi A4 V (8W\_) (05/15--)  
 Audi A6 V (C8, 4A2) (02/18--)  
 Audi Q5 II (FY\_) (05/16--)

Audi A5 II (F5\_) (06/16--)  
 Audi A7 II Sportback (4K\_) (10/17--)

**Tie rod end****116 020 0053/HD****MTE0849HD****Notes**

Carbon Neutral  
 Front Axle Left  
 outer  
 Length [mm] 207  
 Paired article number 116 020 0052/HD | MTE0848HD  
 Required quantity 1  
 Thread Size 1 M14x1,5  
 Thread Size 2 M16x1,5  
 reinforced version  
 replacement in pairs recommended

**References**

Audi 8W0 423 811 B  
 Audi (FAW) 8W0 423 811 B

Audi 8W0 423 811 C  
 Audi (FAW) 8W0 423 811 C

**Application info**

Audi A4 V (8W\_) (05/15--)  
 Audi A6 V (C8, 4A2) (02/18--)  
 Audi Q5 II (FY\_) (05/16--)

Audi A5 II (F5\_) (06/16--)  
 Audi A7 II Sportback (4K\_) (10/17--)

**Tie rod end****116 020 0054/HD****MTE0836HD****Notes**

Carbon Neutral  
 Front Axle Right  
 Cone Size [mm] 16  
 Length [mm] 210  
 Paired article number 116 020 0055/HD | MTE0837HD  
 Required quantity 1  
 Thread Size 1 M14x1,5  
 Thread Size 2 M20x1,5  
 reinforced version  
 replacement in pairs recommended

**References**

MAN 65.46710.0002

Volkswagen 2N0 423 812

**Application info**

MAN TGE (11/16--)

Volkswagen Crafter II (SY\_) (09/16--)

**Tie rod end****116 020 0055/HD****MTE0837HD****Notes**

Carbon Neutral

Front Axle Left

Cone Size [mm]

16

Length [mm]

210

Paired article number

116 020 0054/HD | MTE0836HD

Required quantity

1

Thread Size 1

M14x1,5

Thread Size 2

M20x1,5

reinforced version

replacement in pairs recommended

**References**

MAN 65.46710.0001

Volkswagen 2N0 423 811

**Application info**

MAN TGE (11/16--)

Volkswagen Crafter II (SY\_) (09/16--)

**Tie rod end****116 020 0056/HD****MTE0897HD****Notes**

Carbon Neutral

Front Axle Right

Length [mm]

94

Paired article number

116 020 0057/HD | MTE0898HD

Required quantity

1

Thread Size 1

M12x1,5

Thread Size 2

M16x1,5

reinforced version

replacement in pairs recommended

**References**

Audi 2Q0 423 812

Seat 2Q0 423 812

Skoda 2Q0 423 812

Volkswagen 2Q0 423 812

**Application info**

Audi A1 II (GB\_) (07/18--)  
 Seat Ibiza V (KJ1) (01/17--)  
 Skoda Kamiq (07/19--)  
 Volkswagen Nivus / Taigo (11/21--)  
 Volkswagen T-Cross (12/18--)

Seat Arona (KJ7) (07/17--)  
 Skoda Fabia IV (PJ3) (06/21--)  
 Skoda Scala (02/19--)  
 Volkswagen Polo (AW1) (06/17--)

**Tie rod end****116 020 0057/HD****MTE0898HD****Notes**

Carbon Neutral  
 Front Axle Left

Length [mm] 94  
 Paired article number 116 020 0056/HD | MTE0897HD  
 Required quantity 1  
 Thread Size 1 M12x1,5  
 Thread Size 2 M16x1,5  
 reinforced version  
 replacement in pairs recommended

**References**

Audi 2Q0 423 811  
 Skoda 2Q0 423 811

Seat 2Q0 423 811  
 Volkswagen 2Q0 423 811

**Application info**

Audi A1 II (GB\_) (07/18--)  
 Seat Ibiza V (KJ1) (01/17--)  
 Skoda Kamiq (07/19--)  
 Volkswagen Nivus / Taigo (11/21--)  
 Volkswagen T-Cross (12/18--)

Seat Arona (KJ7) (07/17--)  
 Skoda Fabia IV (PJ3) (06/21--)  
 Skoda Scala (02/19--)  
 Volkswagen Polo (AW1) (06/17--)

**Tie rod end****116 020 0058/HD****MTE0932HD****Notes**

Carbon Neutral  
 Front Axle Left  
 Front Axle Right

Length [mm] 120  
 Required quantity 2  
 Thread Size 1 M12x1,5  
 Thread Size 2 M14x1,5  
 reinforced version  
 replacement in pairs recommended



**References**

Audi 420 419 811 A

**Application info**

Audi R8 I (42\_) (04/07-07/15)

**Tie rod end**

116 020 0059/HD

MTE0979HD

**Notes**

Carbon Neutral

Front Axle Left

94

Length [mm]

Paired article number

Required quantity

1

Thread Size 1

M12x1,5

Thread Size 2

M16x1,5

reinforced version

replacement in pairs recommended

**References**

Audi 5WA 423 811 D

CUPRA 5WA 423 811 C

Seat 5WA 423 811 B

Seat 5WA 423 811 E

Skoda 5WA 423 811 C

Skoda 5WA 423 811 E

Volkswagen 3QF 423 811 B

Volkswagen 5WA 423 811 B

Volkswagen 5WA 423 811 E

Audi 5WA 423 811 E

CUPRA 5WA 423 811 E

Seat 5WA 423 811 D

Skoda 5WA 423 811 B

Skoda 5WA 423 811 D

Volkswagen 3QF 423 811 A

Volkswagen 3QF 423 811 C

Volkswagen 5WA 423 811 D

**Application info**

Audi A3 IV (8Y\_) (11/19--)

Seat Leon IV (KL\_) (11/19--)

Volkswagen Atlas (12/16--)

Volkswagen Golf VIII (CB1) (07/19--)



CUPRA FORMENTOR (KM\_) (07/20--)

Skoda Octavia IV (NX\_) (11/19--)

Volkswagen Caddy V (SBB, SBJ) (09/20--)

Volkswagen Tiguan II (AD1, BW2) (01/16--)



Tie rod end		116 020 0060/HD	MTE0980HD
<b>Notes</b>  Front Axle Right outer Length [mm] 94 Paired article number 116 020 0059/HD   MTE0979HD Required quantity 1 Thread Size 1 M12x1,5 Thread Size 2 M16x1,5 replacement in pairs recommended			
<b>References</b> Audi 5WA 423 812 E CUPRA 5WA 423 812 C CUPRA 5WA 423 812 E Seat 5WA 423 812 E Skoda 5WA 423 812 B Skoda 5WA 423 812 C Skoda 5WA 423 812 D Skoda 5WA 423 812 E Volkswagen 3QF 423 812 A Volkswagen 3QF 423 812 B Volkswagen 3QF 423 812 C Volkswagen 5WA 423 812 B Volkswagen 5WA 423 812 D Volkswagen 5WA 423 812 E			
<b>Application info</b> Audi A3 IV (8Y_) (11/19--) Seat Leon IV (KL_) (11/19--) Volkswagen Atlas (12/16--) Volkswagen Golf VIII (CB1) (07/19--) CUPRA FORMENTOR (KM_) (07/20--) Skoda Octavia IV (NX_) (11/19--) Volkswagen Caddy V (SBB, SBJ) (09/20--) Volkswagen Tiguan II (AD1, BW2) (01/16--)			
Tie rod end		116 020 0061	MTE0990
<b>Notes</b>  Front Axle Left Front Axle Right Length [mm] 98 Required quantity 2 Thread Size 1 M16x1,5 Thread Size 2 M12x1,5 replacement in pairs recommended			
<b>References</b> Audi 1EA 423 811 B Audi 1EB 422 811 A CUPRA 1EA 423 811 B CUPRA 1EB 422 811 A Skoda 1EA 423 811 B Skoda 1EB 422 811 A Volkswagen 1EA 423 811 B			

**Application info**

Audi Q4 (F4\_) (03/21--)  
 Skoda Enyaq iV (5A\_) (10/20--)  
 Volkswagen ID.4 (E21) (05/20--)  
 Volkswagen ID.7 (06/23--)

CUPRA BORN (K11) (08/21--)  
 Volkswagen ID.3 (E11\_) (11/19--)  
 Volkswagen ID.5 (E39) (07/21--)

**Tie rod end**

**116 020 0062/HD**

**MTE0993HD**

**Notes**

Front Axle Right  
 outer  
 Length [mm] 192  
 Paired article number 116 020 0063/HD | MTE0994HD  
 Required quantity 1  
 Thread Size 1 M12x1,5  
 Thread Size 2 M16x1,5  
 reinforced version  
 replacement in pairs recommended



**References**

Audi 9J1 423 812 A  
 Porsche 9J1 423 812 A

Audi 9J1 423 812 B  
 Porsche 9J1 423 812 B

**Application info**

Audi E-TRON (GE\_) (09/18--)

Porsche Taycan (Y1\_) (05/19--)

**Tie rod end**

**116 020 0063/HD**

**MTE0994HD**

**Notes**

Front Axle Left  
 outer  
 Length [mm] 192  
 Paired article number 116 020 0062/HD | MTE0993HD  
 Required quantity 1  
 Thread Size 1 M12x1,5  
 Thread Size 2 M16x1,5  
 reinforced version  
 replacement in pairs recommended



**References**

Audi 9J1 423 811 A  
 Porsche 9J1 423 811 A

Audi 9J1 423 811 B  
 Porsche 9J1 423 811 B

**Application info**

Audi E-TRON (GE\_) (09/18--)

Porsche Taycan (Y1\_) (05/19--)

## Tie rod end

116 020 7106

MTE0141

## Notes

	Front Axle Right
Length [mm]	75
Paired article number	116 020 7139   MTE0142
Required quantity	1
Thread Size 1	M12x1,5
Thread Size 2	M14x1,5
replacement in pairs recommended	



## References

Seat 191 419 812	Seat 3A0 422 812
Seat 6N0 419 812	Seat 6N0 422 812
Volkswagen 191 419 812	Volkswagen 3A0 422 812
Volkswagen 6N0 419 812	Volkswagen 6N0 422 812
Volkswagen (FAW) 191 419 812	

## Application info

Seat Arosa (6H) (05/97-06/04)	Seat Ibiza II / Cordoba I / Inca (6K_) (02/93-11/03)
Seat Toledo I (1L_) (01/91-10/99)	Volkswagen Caddy II (9K9, 9K9B, 9U7) (11/95-06/09)
Volkswagen Corrado (53l) (08/87-12/95)	Volkswagen Golf II (19E) (08/83-12/92)
Volkswagen Golf III (1H1, 1H5, 1E7) (10/89-12/02)	Volkswagen Jetta II (19E) (08/83-12/92)
Volkswagen Lupo (09/98-07/05)	Volkswagen Passat (35l) (02/88-12/97)
Volkswagen Polo (6K_) (01/95-11/09)	Volkswagen Polo (6N_) (09/94-10/01)
Volkswagen Polo Playa (01/95-11/09)	Volkswagen Santana (02/93-09/12)
Volkswagen Vento (11/91-09/98)	

## Tie rod end

116 020 7139

MTE0142

## Notes

	Front Axle Left
Length [mm]	75
Paired article number	116 020 7106   MTE0141
Required quantity	1
Thread Size 1	M12x1,5
Thread Size 2	M14x1,5
replacement in pairs recommended	



**References**

Seat 191 419 811	Seat 3A0 422 811
Seat 6N0 419 811	Seat 6N0 422 811
Volkswagen 191 419 811	Volkswagen 3A0 422 811
Volkswagen 3A0 422 811 A	Volkswagen 6N0 419 811
Volkswagen 6N0 422 811	Volkswagen (FAW) 191 419 811

**Application info**

Seat Arosa (6H) (05/97-06/04)	Seat Ibiza II / Cordoba I / Inca (6K_) (02/93-11/03)
Seat Toledo I (1L_) (01/91-10/99)	Volkswagen Caddy II (9K9, 9K9B, 9U7) (11/95-06/09)
Volkswagen Corrado (53I) (08/87-12/95)	Volkswagen Golf II (19E) (08/83-12/92)
Volkswagen Golf III (1H1, 1H5, 1E7) (10/89-12/02)	Volkswagen Jetta II (19E) (08/83-12/92)
Volkswagen Lupo (09/98-07/05)	Volkswagen Passat (35I) (02/88-12/97)
Volkswagen Polo (6K_) (01/95-11/09)	Volkswagen Polo (6N_) (09/94-10/01)
Volkswagen Polo Playa (01/95-11/09)	Volkswagen Santana (02/93-09/12)
Volkswagen Vento (11/91-09/98)	

**Tie rod end****116 020 8122****MTE0147****Notes**

	Front Axle
Length [mm]	94
Paired article number	116 020 8123   MTE0148
Required quantity	1
Thread Size 1	M12x1,5
Thread Size 2	M14x1,5
replacement in pairs recommended	

**References**

Audi 8Z0 419 812 A	Seat 6E0 419 812
Seat 6K0 422 811	Seat 6X0 422 811
Volkswagen 6E0 419 812	Volkswagen 6K0 422 811
Volkswagen 6X0 422 811	

**Application info**

Audi A2 (8Z0) (02/00-08/05)	Seat Arosa (6H) (05/97-06/04)
Seat Ibiza II / Cordoba I / Inca (6K_) (02/93-11/03)	Volkswagen Caddy II (9K9, 9K9B, 9U7) (11/95-06/09)
Volkswagen Lupo (09/98-07/05)	Volkswagen Polo (6K_) (01/95-11/09)
Volkswagen Polo (6N_) (09/94-10/01)	Volkswagen Polo Playa (01/95-11/09)

## Tie rod end

116 020 8123

MTE0148

## Notes

	Front Axle
Length [mm]	94
Paired article number	116 020 8122   MTE0147
Required quantity	1
Thread Size 1	M12x1,5
Thread Size 2	M14x1,5
replacement in pairs recommended	



## References

Audi 8Z0 419 811 A	Seat 6E0 419 811
Seat 6K0 422 812	Seat 6X0 422 812
Volkswagen 6E0 419 811	Volkswagen 6K0 422 812
Volkswagen 6X0 422 812	

## Application info

Audi A2 (8Z0) (02/00-08/05)	Seat Arosa (6H) (05/97-06/04)
Seat Ibiza II / Cordoba I / Inca (6K_) (02/93-11/03)	Volkswagen Caddy II (9K9, 9K9B, 9U7) (11/95-06/09)
Volkswagen Lupo (09/98-07/05)	Volkswagen Polo (6K_) (01/95-11/09)
Volkswagen Polo (6N_) (09/94-10/01)	Volkswagen Polo Playa (01/95-11/09)

## Tie rod end

116 020 8203/HD

MTE0149HD

## Notes

	Carbon Neutral
	Front Axle Right
Length [mm]	86
Paired article number	116 020 8204/HD   MTE0150HD
Required quantity	1
Thread Size 1	M12x1,5
Thread Size 2	M16x1,5
reinforced version	
replacement in pairs recommended	







## References

Volkswagen 701 419 812 D	Volkswagen 702 419 804 C
--------------------------	--------------------------

## Application info

Volkswagen Transporter IV (07/90-06/03)
---

Tie rod end		116 020 8204/HD	MTE0150HD
<b>Notes</b>  Carbon Neutral Front Axle Left Length [mm] 86 Paired article number 116 020 8203/HD   MTE0149HD Required quantity 1 Thread Size 1 M12x1,5 Thread Size 2 M16x1,5 reinforced version replacement in pairs recommended			
<b>References</b> Volkswagen 701 419 803 E		Volkswagen 701 419 811 E	
<b>Application info</b> Volkswagen Transporter IV (07/90-06/03)			
Tie rod end		116 020 8215	MTE0153
<b>Notes</b>  Front Axle Left Length [mm] 85 Paired article number 116 020 8217   MTE0155 Required quantity 1 Thread Size 1 M12x1,5 Thread Size 2 M16x1,5 replacement in pairs recommended			
<b>References</b> Volkswagen 701 419 803 C Volkswagen 702 419 803 A		Volkswagen 701 419 811 A	
<b>Application info</b> Volkswagen Transporter IV (07/90-06/03)			

Tie rod end		116 020 8216	MTE0154
<p><b>Notes</b></p> <p>Front Axle Left</p> <p>Length [mm] 85</p> <p>Paired article number 116 020 8218   MTE0156</p> <p>Required quantity 1</p> <p>Thread Size 1 M12x1,5</p> <p>Thread Size 2 M16x1,5</p> <p>replacement in pairs recommended</p>			
<p><b>References</b></p> <p>Volkswagen 701 419 811 B</p>			
<p><b>Application info</b></p> <p>Volkswagen Transporter IV (07/90-06/03)</p>			
Tie rod end		116 020 8217	MTE0155
<p><b>Notes</b></p> <p>Front Axle Right</p> <p>Length [mm] 85</p> <p>Paired article number 116 020 8215   MTE0153</p> <p>Required quantity 1</p> <p>Thread Size 1 M12x1,5</p> <p>Thread Size 2 M16x1,5</p> <p>replacement in pairs recommended</p>			
<p><b>References</b></p> <p>Volkswagen 701 419 804 C Volkswagen 701 419 812</p>			
<p><b>Application info</b></p> <p>Volkswagen Transporter IV (07/90-06/03)</p>			

## Tie rod end

116 020 8218

MTE0156

## Notes

Front Axle Right

Length [mm]

85

Paired article number

116 020 8216 | MTE0154

Required quantity

1

Thread Size 1

M12x1,5

Thread Size 2

M16x1,5

replacement in pairs recommended



## References

Volkswagen 701 419 812 A

## Application info

Volkswagen Transporter IV (07/90-06/03)

## Tie rod end

116 020 8228/HD

MTE0158HD

## Notes

Carbon Neutral

Front Axle Left

Front Axle Right

Length [mm]

155

Required quantity

2

Thread Size 1

M8x1,25

Thread Size 2

M14x1,5

reinforced version

replacement in pairs recommended



## References

Audi 4B0 419 811 F

Audi 4F0 419 811 E

Audi 8E0 419 811 B

Skoda 8E0 419 811 B

Volkswagen 4B0 419 811 E

Volkswagen 4D0 419 811 A

Volkswagen 4F0 419 811 E

Volkswagen 8E0 419 811 B

Volkswagen (SVW) 8E0 419 811 B

Audi 4D0 419 811 H

Audi 4F0 498 811

Audi (FAW) 8E0 419 811 B

Volkswagen 4B0 419 811 B

Volkswagen 4B0 419 811 F

Volkswagen 4D0 419 811 B

Volkswagen 8D0 498 998 A

Volkswagen (SVW) 4B0 419 811 E



**Application info**

Audi A4 Cabriolet (8H\_) (01/02-12/09)  
 Audi A4 II (8E\_) (02/00-12/05)  
 Audi A8 I (4D\_) (03/94-12/05)  
 Skoda Superb I (3U) (12/01-03/08)

Audi A4 I (8D\_) (11/94-12/02)  
 Audi A6 II (4B, C5) (01/97-12/05)  
 Audi Allroad (4BH) (05/00-08/05)  
 Volkswagen Passat (3B\_) (08/96-12/05)

**Tie rod end****116 020 8260/HD****MTE0159HD****Notes**

Carbon Neutral  
 Front Axle Right  
 Length [mm] 220  
 Paired article number 116 020 8261/HD | MTE0160HD  
 Required quantity 1  
 Thread Size 1 M12x1,5  
 Thread Size 2 M14x1,5  
 reinforced version  
 replacement in pairs recommended

**References**

Ford 1 058 378  
 Ford 1 234 258  
 Ford 95VW-3280-BB  
 Seat 7M0 422 818 A  
 Seat 7M3 422 818  
 Volkswagen 7M0 422 818 B

Ford 1 092 377  
 Ford 3M21-3280-AA  
 Ford 95VW-3280-BC  
 Seat 7M0 422 818 B  
 Volkswagen 7M0 422 818 A  
 Volkswagen 7M3 422 818

**Application info**

Ford Galaxy I (03/95-05/06)  
 Volkswagen Sharan (7M) (05/95-03/10)

Seat Alhambra I (7V8, 7V9) (03/96-03/10)

**Tie rod end****116 020 8261/HD****MTE0160HD****Notes**

Carbon Neutral  
 Front Axle Left  
 Length [mm] 220  
 Paired article number 116 020 8260/HD | MTE0159HD  
 Required quantity 1  
 Thread Size 1 M12x1,5  
 Thread Size 2 M14x1,5  
 reinforced version  
 replacement in pairs recommended



**References**

Ford 1 058 380

Ford 1 234 259

Ford 95VW-3281-BB

Seat 7M0 422 817 A

Seat 7M3 422 817

Volkswagen 7M0 422 817 B

Ford 1 092 380

Ford 3M21-3281-AA

Ford 95VW-3281-BC

Seat 7M0 422 817 B

Volkswagen 7M0 422 817 A

Volkswagen 7M3 422 817

**Application info**

Ford Galaxy I (03/95-05/06)

Volkswagen Sharan (7M) (05/95-03/10)

Seat Alhambra I (7V8, 7V9) (03/96-03/10)

**Tie rod end****116 020 8283****MTE0162****Notes**

Front Axle Left  
for vehicles with power steering

Length [mm]

75

Manufacturer Restriction

ZF

Paired article number

116 020 8285 | MTE0163

Required quantity

1

Thread Size 1

M12x1,5

Thread Size 2

M14x1,5

replacement in pairs recommended

**References**

Audi 1J0 422 811 A

Volkswagen 1J0 422 811

Skoda 1J0 422 811 A

Volkswagen 1J0 422 811 A

**Application info**

Audi A3 I (8L\_) (09/96-09/06)

Volkswagen Golf IV (1J1, 1J5) (08/97-06/14)

Skoda Octavia I (1U\_) (09/96-12/10)

Volkswagen New Beetle (1Y7, 9C1, 1C1) (01/98-12/11)

## Tie rod end

116 020 8285

MTE0163

## Notes

Front Axle Right  
for vehicles with power steering  
with left-hand thread

Length [mm]	75
Manufacturer Restriction	ZF
Paired article number	116 020 8283   MTE0162
Required quantity	1
Thread Size 1	M12x1,5
Thread Size 2	M14x1,5
replacement in pairs recommended	



## References

Audi 1J0 422 812 A

Volkswagen 1J0 422 812

Skoda 1J0 422 812 A

Volkswagen 1J0 422 812 A

## Application info

Audi A3 I (8L\_) (09/96-09/06)

Volkswagen Golf IV (1J1, 1J5) (08/97-06/14)

Skoda Octavia I (1U\_) (09/96-12/10)

Volkswagen New Beetle (1Y7, 9C1, 1C1) (01/98-12/11)

## Tie rod end

116 020 8502

MTE0164

## Notes

94

Length [mm]	94
Paired article number	116 020 8503   MTE0165
Required quantity	1
Thread Size 1	M12x1,5
Thread Size 2	M14x1,5
replacement in pairs recommended	



## References

Audi 1J0 422 811 B

Seat 1J0 422 811 B

Skoda 1J0 422 811 B

Volkswagen 1J0 422 811 E

Volkswagen (FAW) 1JD 422 811

Volkswagen (SVW) 1JD 422 811

Audi 8Z0 423 812 A

Seat 1J0 422 811 E

Volkswagen 1J0 422 811 B

Volkswagen (FAW) 1J0 422 811 B

Volkswagen (FAW) L1JD 422 811

**Application info**

Audi A2 (8Z0) (02/00-08/05)

Seat Leon I / Toledo II (1M\_) (10/98-06/06)

Volkswagen Bora (1J2, 1J6) (10/98-12/13)

Volkswagen Jetta City (09/06-12/09)

Audi A3 I (8L\_) (09/96-09/06)

Skoda Octavia I (1U\_) (09/96-12/10)

Volkswagen Golf IV (1J1, 1J5) (08/97-06/14)

Volkswagen New Beetle (1Y7, 9C1, 1C1) (01/98-12/11)

**Tie rod end**

**116 020 8503**

**MTE0165**

**Notes**

Length [mm] 94  
 Paired article number 116 020 8502 | MTE0164  
 Required quantity 1  
 Thread Size 1 M12x1,5  
 Thread Size 2 M14x1,5  
 replacement in pairs recommended



**References**

Audi 1J0 422 812 B

Seat 1J0 422 812 B

Skoda 1J0 422 812 B

Volkswagen 1J0 422 812 E

Volkswagen (FAW) 1JD 422 812

Volkswagen (SVW) 1JD 422 812

Audi 8Z0 423 811 A

Seat 1J0 422 812 E

Volkswagen 1J0 422 812 B

Volkswagen (FAW) 1J0 422 812 B

Volkswagen (FAW) L1JD 422 812

**Application info**

Audi A2 (8Z0) (02/00-08/05)

Seat Leon I / Toledo II (1M\_) (10/98-06/06)

Volkswagen Bora (1J2, 1J6) (10/98-12/13)

Volkswagen Jetta City (09/06-12/09)

Audi A3 I (8L\_) (09/96-09/06)

Skoda Octavia I (1U\_) (09/96-12/10)

Volkswagen Golf IV (1J1, 1J5) (08/97-06/14)

Volkswagen New Beetle (1Y7, 9C1, 1C1) (01/98-12/11)

**Tie rod end**

**116 020 9029**

**MTE0169**

**Notes**

Front Axle Left  
 inner  
 Length [mm] 88  
 Paired article number 116 020 9024 | MTE0167  
 Required quantity 1  
 Thread Size 1 M10x1,0  
 Thread Size 2 M14x1,5  
 replacement in pairs recommended



**DRIVER'S BEST FRIEND**

**MEYLE**

**References**

Volkswagen 113 415 821

Volkswagen 113 415 821 A

**Application info**

Volkswagen Käfer / Karmann Ghia (12/47-08/03)

## Suspension

## Axle support bushing

014 710 0007

MAB0169

## Notes

Front  
Hydro Mount  
Rear Axle Left  
Rear Axle Right

Height [mm] 77  
Inner Diameter [mm] 18  
Outer Diameter [mm] 77  
Required quantity 2  
replacement in pairs recommended



## References

Mercedes-Benz 204 351 03 42  
Mercedes-Benz A 204 351 03 42  
Mercedes-Benz (BBDC) 204 351 08 42

Mercedes-Benz 204 351 08 42  
Mercedes-Benz A 204 351 08 42  
Mercedes-Benz (BBDC) A 204 351 08 42

## Application info

Mercedes-Benz BM 204 (C-Class) (01/07--)  
Mercedes-Benz BM 207 (E-Class) (01/09-12/16)  
Mercedes-Benz BM 218 (CLS) (01/11-12/17)

Mercedes-Benz BM 204 (GLK-Class) (06/08-12/15)  
Mercedes-Benz BM 212 (E-Class) (01/09-12/16)  
Mercedes-Benz BM 231 (SL) (01/12--)

## Axle support bushing

100 710 0024

MAB0188

## Notes

Front  
Rear Axle Left  
Rear Axle Right

Height [mm] 76  
Inner Diameter [mm] 18  
Outer Diameter [mm] 61  
Required quantity 2  
replacement in pairs recommended





## References

Volkswagen 3C0 505 145

## Application info

Volkswagen CC (11/11-12/16)  
Volkswagen Passat (3C\_) (03/05-01/12)

Volkswagen Passat (362, 365) (08/10-12/15)

Axle support bushing		100 710 0025	MAB0189
<b>Notes</b>  Rear Rear Axle Left Rear Axle Right  Height [mm] 76 Inner Diameter [mm] 18 Outer Diameter [mm] 54 Required quantity 2 replacement in pairs recommended			
<b>References</b> Volkswagen 3C0 505 145 A			
<b>Application info</b> Volkswagen CC (11/11-12/16) Volkswagen Passat (362, 365) (08/10-12/15) Volkswagen Passat (3C_) (03/05-01/12)			
Axle support bushing		100 710 0028	MAB0200
<b>Notes</b>  Rear Axle Left Rear Axle Right  Height [mm] 64 Inner Diameter [mm] 10 Outer Diameter [mm] 58 Required quantity 2 replacement in pairs recommended			
<b>References</b> Seat 1S0 501 541 B Seat 1S0 501 541 F Skoda 1S0 501 541 B Skoda 1S0 501 541 F Volkswagen 1S0 501 541 B Volkswagen 1S0 501 541 F			
<b>Application info</b> Seat Mii (10/11--) Skoda Citigo (10/11--) Volkswagen UP (08/11--)			

## Axle support bushing

11-14 710 0005

MAB0215

## Notes

Rear Axle Left  
Rear Axle RightHeight [mm] 84.8  
Inner Diameter [mm] 12  
Outer Diameter [mm] 59  
Required quantity 2  
replacement in pairs recommended

## References

Citroën 5131 C9

Peugeot 5131.C9

Toyota 48725-0H010

## Application info

Citroën C1 (06/05-09/14)

Citroën C1 II (04/14--)

Peugeot 107 (06/05-05/14)

Peugeot 108 (05/14--)

Toyota Aygo I (02/05-05/14)

Toyota Aygo II (05/14--)

## Axle support bushing

11-14 710 0019

MAB0195

## Notes

Rear Axle Left  
Rear Axle RightHeight [mm] 78.5  
Inner Diameter [mm] 14  
Outer Diameter [mm] 82.5  
Required quantity 2  
replacement in pairs recommended

## References

Citroën 5131.H1

Citroën 96 810 170 80

Peugeot 5131.H1

Peugeot 96 81 017 080

## Application info

Citroën Berlingo II (04/08--)

Peugeot Partner II (04/08--)



## Axle support bushing

11-14 710 0024

MAB0181

## Notes

Rear Axle Left  
Rear Axle RightHeight [mm] 82.5  
Inner Diameter [mm] 12  
Outer Diameter [mm] 72  
Required quantity 2  
replacement in pairs recommended

## References

Citroën 5131.G4

Peugeot 5131.G4

## Application info

Citroën C4 I / Coupe / Grand Picasso / Picasso / Stufenheck  
(11/04--)

Citroën C4 II / DS4 (02/09--)

Peugeot 308 I (09/07--)

Peugeot RCZ (03/10-12/15)

## Axle support bushing

11-14 710 0025

MAB0182

## Notes

Rear Axle Left  
Rear Axle RightHeight [mm] 30  
Inner Diameter [mm] 12  
Outer Diameter [mm] 47  
Required quantity 2  
replacement in pairs recommended

## References

Citroën 5131.47

Peugeot 5131.47

## Application info

Citroën Berlingo I (07/96-12/11)

Peugeot 405 (01/87-12/99)

Peugeot Partner I (05/96--)

**Ball joint**

016 010 0000

MBJ0001

**Notes**

Front Axle Left  
 Front Axle Right  
 Upper  
 with accessories  
 with right-hand thread

Length [mm]

28

Required quantity

2

Thread Size

M12x1,5

replacement in pairs recommended

**References**

Mercedes-Benz 168 330 01 27

Mercedes-Benz 168 333 01 27

Mercedes-Benz 168 333 02 27

Mercedes-Benz A 168 330 01 27

Mercedes-Benz A 168 333 01 27

Mercedes-Benz A 168 333 02 27

**Application info**

Mercedes-Benz BM 168 (A-Class) (07/97-08/05)

**Ball joint**

016 010 0002/HD

MBJ0003HD

**Notes**

Carbon Neutral  
 Front Axle Left  
 Front Axle Right  
 Lower  
 outer  
 with accessories

Cone Size [mm]

17.3

Height [mm]

91.8

Outer Diameter [mm]

41

Required quantity

2

Thread Size

M14x1,5

reinforced version

replacement in pairs recommended



**References**

- |                                    |                                      |
|------------------------------------|--------------------------------------|
| Mercedes-Benz 211 330 02 35        | Mercedes-Benz 211 330 04 35          |
| Mercedes-Benz 220 333 01 27        | Mercedes-Benz 220 333 02 27          |
| Mercedes-Benz 220 333 03 27        | Mercedes-Benz 220 333 04 27          |
| Mercedes-Benz 220 333 07 27        | Mercedes-Benz A 211 330 02 35        |
| Mercedes-Benz A 211 330 04 35      | Mercedes-Benz A 220 333 01 27        |
| Mercedes-Benz A 220 333 02 27      | Mercedes-Benz A 220 333 03 27        |
| Mercedes-Benz A 220 333 04 27      | Mercedes-Benz A 220 333 07 27        |
| Mercedes-Benz (BBDC) 211 330 04 35 | Mercedes-Benz (BBDC) A 211 330 04 35 |

**Application info**

- |  |  |
|--|--|
| Mercedes-Benz BM 211 (E-Class) (03/02-07/09) | Mercedes-Benz BM 215 (S-Class) (03/99-12/06) |
| Mercedes-Benz BM 219 (CLS) (10/04-02/11)     | Mercedes-Benz BM 220 (S-Class) (09/98-08/05) |
| Mercedes-Benz BM 230 (SL) (10/01-01/12)      |  |

**Ball joint**

016 010 0003

MBJ0004

**Notes**

Front Axle Left  
 Front Axle Right  
 Lower  
 with accessories

Required quantity 2  
 Thread Size 1 M14x1,5  
 Thread Size 2 M14x1,5  
 replacement in pairs recommended



**References**

- |                                    |                                      |
|------------------------------------|--------------------------------------|
| Mercedes-Benz 212 330 01 35        | Mercedes-Benz A 212 330 01 35        |
| Mercedes-Benz (BBDC) 212 330 01 35 | Mercedes-Benz (BBDC) A 212 330 01 35 |

**Application info**

- |  |  |
|--|--|
| Mercedes-Benz BM 212 (E-Class) (01/09-12/16) | Mercedes-Benz BM 218 (CLS) (01/11-12/17) |
|--|--|

**Ball joint**

016 010 0004/HD

MBJ0005HD

**Notes**

Carbon Neutral  
 Front Axle Left  
 Front Axle Right  
 Lower  
 with accessories

Required quantity

2

Thread Size

M14x1,5

reinforced version

replacement in pairs recommended

**References**

Mercedes-Benz 163 330 00 35

Mercedes-Benz 163 330 01 35

Mercedes-Benz A 163 330 00 35

Mercedes-Benz A 163 330 01 35

**Application info**

Mercedes-Benz BM 163 (M-Class) (02/98-07/05)

**Ball joint**

016 010 0005/HD

MBJ0006HD

**Notes**

Carbon Neutral  
 Front Axle Left  
 Front Axle Right

Required quantity

2

Thread Size

M12x1,5

reinforced version

replacement in pairs recommended

**References**

Smart 0014224V002

Smart 0014224V002000000

Smart 0015642V002000000

Smart 14224V001000

Smart 14224V002000000

Smart 2271V007000005

**Application info**

Smart City Coupé / Cabrio (07/98-01/04)

Smart Crossblade (06/02-12/03)

Smart Fortwo I (01/04-02/07)

Smart Roadster (04/03-11/05)

**Ball joint****016 010 0006/HD****MBJ0007HD****Notes**

Carbon Neutral  
Lower  
Rear Axle Left  
Rear Axle Right  
with accessories

Required quantity

2

Thread Size

M14x1,5

reinforced version

replacement in pairs recommended

**References**

Mercedes-Benz 163 350 00 13

Mercedes-Benz 163 350 01 13

Mercedes-Benz A 163 350 00 13

Mercedes-Benz A 163 350 01 13

**Application info**

Mercedes-Benz BM 163 (M-Class) (02/98-07/05)

**Ball joint****016 010 0009****MBJ0008****Notes**

Front Axle Left  
Front Axle Right  
Upper  
with accessories

Required quantity

2

Thread Size

M10x1,5

replacement in pairs recommended

**References**

Mercedes-Benz 000 330 10 07

Mercedes-Benz 211 330 99 07

Mercedes-Benz 211 331 00 83

Mercedes-Benz A 000 330 10 07

Mercedes-Benz A 211 330 99 07

Mercedes-Benz A 211 331 00 83

Mercedes-Benz (BBDC) 000 330 10 07

Mercedes-Benz (BBDC) 211 330 99 07

Mercedes-Benz (BBDC) A 000 330 10 07





Mercedes-Benz (BBDC) A 211 330 99 07

**Application info**

Mercedes-Benz BM 211 (E-Class) (03/02-07/09)

Mercedes-Benz BM 219 (CLS) (10/04-02/11)

Mercedes-Benz BM 230 (SL) (10/01-01/12)

Ball joint		016 010 0010	MBJ0009
<b>Notes</b>  Front Axle Left Front Axle Right Lower inner Required quantity 2 Thread Size M14x1,5 replacement in pairs recommended		 	
<b>References</b> Mercedes-Benz 211 323 00 68 Mercedes-Benz 211 323 03 68 Mercedes-Benz 220 323 03 68 Mercedes-Benz A 211 323 00 68 Mercedes-Benz A 211 323 03 68 Mercedes-Benz A 220 323 03 68			
<b>Application info</b> Mercedes-Benz BM 211 (E-Class) (03/02-07/09) Mercedes-Benz BM 219 (CLS) (10/04-02/11) Mercedes-Benz BM 220 (S-Class) (09/98-08/05) Mercedes-Benz BM 230 (SL) (10/01-01/12) Mercedes-Benz BM 231 (SL) (01/12--)			
Ball joint		016 010 0011	MBJ0010
<b>Notes</b>  Front Axle Left Front Axle Right Lower Required quantity 2 Thread Size M14x1,5 replacement in pairs recommended		 	
<b>References</b> Mercedes-Benz 169 333 00 27 Mercedes-Benz 169 333 01 27 Mercedes-Benz 169 333 03 27 Mercedes-Benz A 169 333 00 27 Mercedes-Benz A 169 333 01 27 Mercedes-Benz A 169 333 03 27			
<b>Application info</b> Mercedes-Benz BM 169 (A-Class) (09/04-06/12) Mercedes-Benz BM 245 (B-Class) (03/05-11/11)			

**Ball joint**

016 010 0012

MBJ0011

**Notes**

Front Axle Left  
 Front Axle Right  
 Lower  
 with retaining ring

Outer Diameter [mm]

40

Required quantity

2

Thread Size

M12x1,5

replacement in pairs recommended

**References**

Mitsubishi MN186217

Smart 454 330 07 07

Smart 454 330 08 07

Smart 454 330 99 99

Smart A 454 330 07 07

Smart A 454 330 08 07

Smart A 454 330 99 99

**Application info**

Mitsubishi Colt VI (10/02-12/12)

Smart Forfour (01/04-06/06)

**Ball joint**

016 010 0013/HD

MBJ0012HD

**Notes**

Carbon Neutral  
 Front Axle Left  
 Front Axle Right  
 Lower  
 with accessories

Required quantity

2

reinforced version

replacement in pairs recommended

**References**

Mercedes-Benz 639 330 04 10

Mercedes-Benz 639 330 05 10

Mercedes-Benz 639 330 08 10

Mercedes-Benz 639 330 09 10

Mercedes-Benz 639 333 02 27

Mercedes-Benz A 639 330 04 10

Mercedes-Benz A 639 330 05 10





Mercedes-Benz A 639 330 08 10

Mercedes-Benz A 639 330 09 10



Mercedes-Benz A 639 333 02 27

**Application info**

Mercedes-Benz BM 639 (Vito / Viano) (08/03--)

Ball joint		016 010 0014	MBJ0013
<b>Notes</b>  Front Axle Left Front Axle Right Lower with accessories  Required quantity 2 Thread Size M14x1,5 replacement in pairs recommended		 	
<b>References</b> Mercedes-Benz 414 333 01 27 Mercedes-Benz 414 333 02 27 Mercedes-Benz A 414 333 01 27 Mercedes-Benz A 414 333 02 27			
<b>Application info</b> Mercedes-Benz BM 414 (Vaneo) (02/02-07/05)			
Ball joint		016 010 0015	MBJ0014
<b>Notes</b>  Front Axle Left Front Axle Right  Height [mm] 106 Outer Diameter [mm] 45 Required quantity 2 Thread Size M20x1,5 replacement in pairs recommended		 	
<b>References</b> Mercedes-Benz 903 330 41 07 Mercedes-Benz 906 330 40 07 Mercedes-Benz A 903 330 41 07 Mercedes-Benz A 906 330 40 07 Volkswagen 2E0 407 151 M Volkswagen 2E0 407 152 M			
<b>Application info</b> Mercedes-Benz BM 220 (S-Class) (09/98-08/05) Mercedes-Benz BM 906 (Sprinter II) (06/06--) Mercedes-Benz BM 907 / 910 (Sprinter III) (02/18--) Volkswagen Crafter I (2E) (04/06-12/16)			



Ball joint		016 010 0016	MBJ0015
<b>Notes</b>  Front Axle Left Front Axle Right Lower with accessories  Height [mm] 87 Outer Diameter [mm] 45 Required quantity 2 Thread Size 1 M16x1,5 Thread Size 2 M42x1,5 replacement in pairs recommended			
<b>References</b> Mercedes-Benz 164 330 09 35		Mercedes-Benz A 164 330 09 35	
<b>Application info</b> Mercedes-Benz BM 164 (GL-Class) (09/06-12/12) Mercedes-Benz BM 251 (R-Class) (08/05-10/17)		Mercedes-Benz BM 164 (M-Class) (02/05-12/12)	
Ball joint		016 010 0017	MBJ0016
<b>Notes</b>  Rear Axle Left Rear Axle Right with accessories  Height [mm] 87 Outer Diameter [mm] 45 Required quantity 2 Thread Size 1 M16x1,5 Thread Size 2 M42x1,5 replacement in pairs recommended			
<b>References</b> Mercedes-Benz 164 352 01 27 Mercedes-Benz A 164 352 01 27		Mercedes-Benz 164 352 03 27 Mercedes-Benz A 164 352 03 27	
<b>Application info</b> Mercedes-Benz BM 164 (GL-Class) (09/06-12/12) Mercedes-Benz BM 251 (R-Class) (08/05-10/17)		Mercedes-Benz BM 164 (M-Class) (02/05-12/12)	

**Ball joint**

016 010 0018/HD

MBJ0017HD

**Notes**

Carbon Neutral  
 Front Axle Left  
 Front Axle Right  
 with accessories

Required quantity

2

Thread Size

M12x1,5

reinforced version

replacement in pairs recommended

**References**

Smart 0014224V002

Smart 0014224V002000000

Smart 0015642V002000000

Smart 14224V001000

Smart 14224V002000000

Smart 2271V007000005

**Application info**

Smart City Coupé / Cabrio (07/98-01/04)

Smart Crossblade (06/02-12/03)

Smart Fortwo I (01/04-02/07)

Smart Roadster (04/03-11/05)

**Ball joint**

016 010 0020

MBJ0018

**Notes**

Front Axle Left  
 Front Axle Right

Height [mm]

76

Required quantity

2

Thread Size

M12x1,5

replacement in pairs recommended



**References**

Smart 451 330 00 10

Smart A 451 330 00 10



**Application info**

Smart Fortwo II (01/07--)

Ball joint		016 010 0021	MBJ0427
<p><b>Notes</b></p> <p>Front Axle Left Front Axle Right Lower outer with accessories</p> <p>Cone Size [mm] 17.3 Height [mm] 91.8 Outer Diameter [mm] 41 Required quantity 2 Thread Size M14x1,5 replacement in pairs recommended</p>		 	

References	
Mercedes-Benz 211 330 02 35	Mercedes-Benz 211 330 04 35
Mercedes-Benz 220 333 01 27	Mercedes-Benz 220 333 02 27
Mercedes-Benz 220 333 03 27	Mercedes-Benz 220 333 04 27
Mercedes-Benz 220 333 07 27	Mercedes-Benz A 211 330 02 35
Mercedes-Benz A 211 330 04 35	Mercedes-Benz A 220 333 01 27
Mercedes-Benz A 220 333 02 27	Mercedes-Benz A 220 333 03 27
Mercedes-Benz A 220 333 04 27	Mercedes-Benz A 220 333 07 27
Mercedes-Benz (BBDC) 211 330 04 35	Mercedes-Benz (BBDC) A 211 330 04 35

Application info	
Mercedes-Benz BM 211 (E-Class) (03/02-07/09)	Mercedes-Benz BM 215 (S-Class) (03/99-12/06)
Mercedes-Benz BM 219 (CLS) (10/04-02/11)	Mercedes-Benz BM 220 (S-Class) (09/98-08/05)
Mercedes-Benz BM 230 (SL) (10/01-01/12)	

Ball joint		016 010 0022	MBJ0428
<p><b>Notes</b></p> <p>Front Axle Left Front Axle Right Lower with accessories</p> <p>Required quantity 2 Thread Size M14x1,5 replacement in pairs recommended</p>		 	

**References**

Mercedes-Benz 163 330 00 35  
 Mercedes-Benz A 163 330 00 35

Mercedes-Benz 163 330 01 35  
 Mercedes-Benz A 163 330 01 35

**Application info**

Mercedes-Benz BM 163 (M-Class) (02/98-07/05)

**Ball joint**

016 010 0023

MBJ0429

**Notes**

Front Axle Left  
 Front Axle Right  
 Lower

Required quantity 2  
 Thread Size 1 M14x1,5  
 Thread Size 2 M14x1,5  
 replacement in pairs recommended



**References**

Chrysler 05099237AA  
 Chrysler 5099237AA  
 Mercedes-Benz 202 333 00 27  
 Mercedes-Benz 210 330 04 27  
 Mercedes-Benz 211 330 03 35  
 Mercedes-Benz A 210 330 00 35  
 Mercedes-Benz A 210 333 04 27

Chrysler 05099237AB  
 Chrysler 5099237AB  
 Mercedes-Benz 210 330 00 35  
 Mercedes-Benz 210 333 04 27  
 Mercedes-Benz A 202 333 00 27  
 Mercedes-Benz A 210 330 04 27  
 Mercedes-Benz A 211 330 03 35

**Application info**

Chrysler Crossfire (07/03-12/08)  
 Mercedes-Benz BM 202 (C-Class) (03/93-03/01)  
 Mercedes-Benz BM 210 (E-Class) (06/95-08/03)  
 Mercedes-Benz BM 220 (S-Class) (09/98-08/05)

Mercedes-Benz BM 170 (SLK) (04/96-04/04)  
 Mercedes-Benz BM 208 (CLK) (06/97-12/03)  
 Mercedes-Benz BM 211 (E-Class) (03/02-07/09)

**Ball joint**

016 010 0026/HD

MBJ0487HD

**Notes**

Carbon Neutral  
 Front Axle Left  
 Front Axle Right  
 Lower  
 outer

Required quantity

2

Thread Size

M18x1,5

replacement in pairs recommended

**References**

Mercedes-Benz 910 333 04 00

Mercedes-Benz A 910 333 04 00

**Application info**

Mercedes-Benz BM 907 / 910 (Sprinter III) (02/18--)

**Ball joint**

016 010 0028

MBJ0482

**Notes**

Front Axle Left  
 Front Axle Right  
 Rear Axle Left  
 Rear Axle Right

Required quantity

2

Thread Size 1

M16x1,5

Thread Size 2

M16x1,5

replacement in pairs recommended

**References**

Mercedes-Benz 167 330 63 00

Mercedes-Benz A 167 330 63 00

**Application info**

Mercedes-Benz BM 167 (GLE) (10/18--)

Mercedes-Benz BM 167 (GLS) (04/19--)

**Ball joint** **016 010 0030** **MBJ0478**

**Notes**

Front Axle Left  
Front Axle Right

Required quantity 2  
Thread Size M16x1,5  
replacement in pairs recommended



**References**

Mercedes-Benz 447 330 14 07  
Mercedes-Benz 447 330 34 00  
Mercedes-Benz 447 330 75 00  
Mercedes-Benz 447 333 01 27  
Mercedes-Benz A 447 330 15 07  
Mercedes-Benz A 447 330 35 00  
Mercedes-Benz A 447 330 76 00

Mercedes-Benz 447 330 15 07  
Mercedes-Benz 447 330 35 00  
Mercedes-Benz 447 330 76 00  
Mercedes-Benz A 447 330 14 07  
Mercedes-Benz A 447 330 34 00  
Mercedes-Benz A 447 330 75 00  
Mercedes-Benz A 447 333 01 27

**Application info**

Mercedes-Benz BM 447 (V-Class) (03/14--)

Mercedes-Benz BM 447 (Vito) (10/14--)

**Ball joint** **016 010 0235** **MBJ0484**

**Notes**

Front Axle Left  
Front Axle Right  
Lower  
outer

Required quantity 2  
Thread Size M16x1,5  
replacement in pairs recommended



**References**

Mercedes-Benz 166 330 02 35

Mercedes-Benz A 166 330 02 35

**Application info**

Mercedes-Benz BM 166 (GL) (07/12-12/15)  
Mercedes-Benz BM 166 (GLS) (11/15-04/19)

Mercedes-Benz BM 166 (GLE) (03/15-10/19)  
Mercedes-Benz BM 166 (M-Class) (06/11-12/15)

**Ball joint**

016 010 6327/HD

MBJ0023HD

**Notes**

Carbon Neutral  
 Front Axle Left  
 Front Axle Right  
 Lower

Required quantity

2

Thread Size 1

M14x1,5

Thread Size 2

M18x1,5

reinforced version

replacement in pairs recommended



**References**

Mercedes-Benz 140 333 03 27

Mercedes-Benz A 140 333 03 27

**Application info**

Mercedes-Benz BM 140 (S-Class) (02/91-12/99)

**Ball joint**

016 010 6331/HD

MBJ0024HD

**Notes**

Carbon Neutral  
 Front Axle Left  
 Front Axle Right  
 Lower

Required quantity

2

Thread Size 1

M14x1,5

Thread Size 2

M14x1,5

reinforced version

replacement in pairs recommended



**References**

Chrysler 05099237AA

Chrysler 05099237AB

Chrysler 5099237AA

Chrysler 5099237AB

Mercedes-Benz 202 333 00 27

Mercedes-Benz 210 330 00 35

Mercedes-Benz 210 330 04 27

Mercedes-Benz 210 333 04 27

Mercedes-Benz 211 330 03 35

Mercedes-Benz A 202 333 00 27

Mercedes-Benz A 210 330 00 35

Mercedes-Benz A 210 330 04 27

Mercedes-Benz A 210 333 04 27

Mercedes-Benz A 211 330 03 35

**Application info**

Chrysler Crossfire (07/03-12/08)

Mercedes-Benz BM 202 (C-Class) (03/93-03/01)

Mercedes-Benz BM 210 (E-Class) (06/95-08/03)

Mercedes-Benz BM 220 (S-Class) (09/98-08/05)

Mercedes-Benz BM 170 (SLK) (04/96-04/04)

Mercedes-Benz BM 208 (CLK) (06/97-12/03)

Mercedes-Benz BM 211 (E-Class) (03/02-07/09)

**Ball joint**

034 010 0003

MBJ0025

**Notes**

Front Axle Left  
 Front Axle Right  
 Lower  
 with accessories

Required quantity  
 replacement in pairs recommended

2



**References**

Mercedes-Benz 638 330 00 10

Mercedes-Benz 638 330 01 10

Mercedes-Benz 638 330 06 10

Mercedes-Benz A 638 330 00 10

Mercedes-Benz A 638 330 01 10

Mercedes-Benz A 638 330 06 10

Mercedes-Benz 638 330 00 27

Mercedes-Benz 638 330 05 10

Mercedes-Benz 638 333 00 27

Mercedes-Benz A 638 330 00 27

Mercedes-Benz A 638 330 05 10

Mercedes-Benz A 638 333 00 27

**Application info**

Mercedes-Benz BM 638 (V-Class / Vito) (02/96-07/03)

**Ball joint**

036 010 0001

MBJ0026

**Notes**

Front Axle Left  
 Front Axle Right

Height [mm]

103

Outer Diameter [mm]

50

Required quantity

2

Thread Size

M16x1,5

replacement in pairs recommended





**References**

Mercedes-Benz 000 320 00 28  
 Mercedes-Benz 608 320 00 28  
 Mercedes-Benz 631 320 00 28  
 Mercedes-Benz A 000 320 00 28  
 Mercedes-Benz A 608 320 00 28  
 Mercedes-Benz A 631 320 00 28

Mercedes-Benz 000 320 01 28  
 Mercedes-Benz 608 320 01 28  
 Mercedes-Benz 631 320 02 28  
 Mercedes-Benz A 000 320 01 28  
 Mercedes-Benz A 608 320 01 28  
 Mercedes-Benz A 631 320 02 28

**Application info**

Mercedes-Benz BM 631 (02/88-04/96)

**Ball joint****036 010 0113/HD****MBJ0027HD****Notes**

Carbon Neutral  
 Front Axle Left  
 Front Axle Right

Required quantity

2

Thread Size

M20x1,5

reinforced version

replacement in pairs recommended

**References**

Mercedes-Benz 901 333 06 27  
 Mercedes-Benz 901 333 10 27  
 Mercedes-Benz 901 333 12 27  
 Mercedes-Benz A 901 333 07 27  
 Mercedes-Benz A 901 333 11 27  
 Volkswagen 2D0 407 361  
 Volkswagen 2D0 407 361 B

Mercedes-Benz 901 333 07 27  
 Mercedes-Benz 901 333 11 27  
 Mercedes-Benz A 901 333 06 27  
 Mercedes-Benz A 901 333 10 27  
 Mercedes-Benz A 901 333 12 27  
 Volkswagen 2D0 407 361 A

**Application info**

Mercedes-Benz BM 901 / 902 (Sprinter I) (01/95-05/06)  
 Mercedes-Benz BM 904 (Sprinter I) (02/95-05/12)  
 Volkswagen LT II (04/96-07/06)

Mercedes-Benz BM 903 (Sprinter I) (01/95-05/12)  
 Mercedes-Benz BM 909 (Sprinter) (09/13--)

**Ball joint** **036 020 0113** **MBJ0028**

**Notes**

Front Axle Left  
 Front Axle Right  
 Height [mm] 52  
 Required quantity 2  
 Thread Size M20x1,5  
 replacement in pairs recommended



**References**

- |                               |                               |
|-------------------------------|-------------------------------|
| Mercedes-Benz 901 333 06 27   | Mercedes-Benz 901 333 07 27   |
| Mercedes-Benz 901 333 10 27   | Mercedes-Benz 901 333 11 27   |
| Mercedes-Benz 901 333 12 27   | Mercedes-Benz A 901 333 06 27 |
| Mercedes-Benz A 901 333 07 27 | Mercedes-Benz A 901 333 10 27 |
| Mercedes-Benz A 901 333 11 27 | Mercedes-Benz A 901 333 12 27 |
| Volkswagen 2D0 407 361        | Volkswagen 2D0 407 361 A      |
| Volkswagen 2D0 407 361 B      |                               |

**Application info**

- |   |   |
|---|---|
| Mercedes-Benz BM 901 / 902 (Sprinter I) (01/95-05/06) | Mercedes-Benz BM 903 (Sprinter I) (01/95-05/12) |
| Mercedes-Benz BM 904 (Sprinter I) (02/95-05/12)       | Mercedes-Benz BM 909 (Sprinter) (09/13--)       |
| Volkswagen LT II (04/96-07/06)                        |   |

**Ball joint** **11-16 010 0000** **MBJ0029**

**Notes**

Front Axle Left  
 Front Axle Right  
 Lower  
 Required quantity 2  
 Thread Size M14x1,5  
 replacement in pairs recommended



**References**

CITROËN (DF-PSA) 3640.60  
 Citroën 16 072 974 80  
 Citroën 3640.68  
 Citroën 3640.73  
 DS 3640 73  
 Peugeot 3640.60  
 Peugeot 3640.70  
 Peugeot 98 17 375 080  
 Peugeot (DF-PSA) 3640.70

CITROËN (DF-PSA) 3640.70  
 Citroën 3640.60  
 Citroën 3640.70  
 Citroën 98 173 750 80  
 Peugeot 3640.53  
 Peugeot 3640.68  
 Peugeot 3640.73  
 Peugeot (DF-PSA) 3640.60

**Application info**

Citroën Berlingo II (04/08--)  
 Citroën C4 I / Coupe / Grand Picasso / Picasso / Stufenheck  
 (11/04--)  
 Citroën DS5 (09/11-07/15)  
 DS DS 5 (04/15-12/18)  
 Peugeot 307 (08/00-12/12)  
 Peugeot 5008 I (06/09-03/17)  
 Peugeot Partner II (04/08--)

Citroën C4 Grand Picasso II (01/13--)  
 Citroën C4 II / DS4 (02/09--)  
 DS DS 4 I (07/15-12/18)  
 Peugeot 3008 I (05/09-12/17)  
 Peugeot 308 I (09/07--)  
 Peugeot 508 I (11/10--)  
 Peugeot RCZ (03/10-12/15)

**Ball joint****11-16 010 0004****MBJ0030****Notes**

Front Axle Left  
 Front Axle Right  
 Lower  
 with accessories  
 2  
 M18x1,5

Required quantity

Thread Size

replacement in pairs recommended

**References**



Citroën 13 004 730 80  
 Fiat 1300473080

Citroën 3640.33  
 Peugeot 3640.33

**Application info**

Citroën Jumper I (02/94-08/02)  
 Fiat Ducato (244) (04/02--)

Fiat Ducato (230) (03/94-05/05)  
 Peugeot Boxer I (03/94-08/05)

Ball joint		11-16 010 0005/HD	MBJ0031HD
<b>Notes</b>  Carbon Neutral Front Axle Left Front Axle Right Lower with accessories  Required quantity 2 Thread Size M16x1,5 reinforced version replacement in pairs recommended			
<b>References</b> Citroën 13 023 680 80 Fiat 1302368080		Citroën 3640.32 Peugeot 3640.32	
<b>Application info</b> Citroën Jumper I (02/94-08/02) Peugeot Boxer I (03/94-08/05)		Fiat Ducato (230) (03/94-05/05)	
Ball joint		11-16 010 0007	MBJ0032
<b>Notes</b>  Front Axle Left Front Axle Right Lower with accessories  Required quantity 2 replacement in pairs recommended			
<b>References</b> Peugeot 3640.48 Peugeot 3840.37		Peugeot 3640.49	
<b>Application info</b> Peugeot 306 (01/93-10/03)			

**Ball joint**

11-16 010 0008

MBJ0033

**Notes**

Front Axle Left  
 Front Axle Right  
 Lower  
 with accessories

Cone Size [mm]

18

Required quantity

2

replacement in pairs recommended

**References**

Citroën 16 072 975 80

Citroën 3640.50

Citroën 3640.52

Peugeot 16 072 976 80

Peugeot 3640.51

Citroën 16 072 976 80

Citroën 3640.51

Peugeot 16 07 297 580

Peugeot 3640.50

**Application info**

Citroën Berlingo I (07/96-12/11)

Citroën Xsara Picasso (09/99-06/12)

Peugeot Partner II (04/08--)

Citroën Xsara (04/97-03/10)

Peugeot Partner I (05/96--)

**Ball joint**

11-16 010 0013

MBJ0035

**Notes**

Front Axle Left  
 Front Axle Right  
 Lower  
 with accessories

Required quantity

2

replacement in pairs recommended



**References**

Citroën 16 072 984 80

Citroën 3640.56

Citroën 3640.61

Citroën 3640.65

DS 3640 62

Peugeot 16 07 298 580

Peugeot 3640.59

Peugeot 3640.62

Peugeot 3640.66

Citroën 16 072 985 80

Citroën 3640.59

Citroën 3640.62

Citroën 3640.66

Peugeot 16 07 298 480

Peugeot 3640.56

Peugeot 3640.61

Peugeot 3640.65

**Application info**

Citroën C2 / C3 I / Pluriel (02/02--)

Citroën C3 Picasso (02/09--)

Citroën DS3 (11/09-12/16)

Peugeot 1007 (04/05--)

Peugeot 207 (02/06--)

Citroën C3 III (07/16--)

Citroën C4 Cactus (09/14--)

DS DS 3 (04/15-07/19)

Peugeot 2008 I (03/13--)

Peugeot 208 I (03/12--)

**Ball joint****11-16 010 0014****MBJ0036****Notes**

Front Axle Left  
 Front Axle Right  
 Lower  
 with accessories

Required quantity

2

Thread Size

M16x1,5

replacement in pairs recommended

**References**

Citroën 16 109 346 80

Citroën 3640.76

Fiat 93501837

Peugeot 3640.67

Citroën 3640.67

Fiat 50705629

Peugeot 16 10 934 680

Peugeot 3640.76

**Application info**

Citroën Jumper III (04/06--)

Peugeot Boxer III (09/05--)

Fiat Ducato (250) (07/06--)

**Ball joint****11-16 010 0017****MBJ0037****Notes**

Front Axle Left  
 Front Axle Right  
 Lower  
 with accessories

Required quantity  
 replacement in pairs recommended

2

**References**

Citroën 3640.77  
 Citroën 98 194 181 80  
 DS 3640 77  
 GENERAL MOTORS 3647087  
 Opel 36 47 087

Citroën 98 093 384 80  
 Citroën 98 194 182 80  
 GENERAL MOTORS 3647086  
 Opel 36 47 086  
 Peugeot 3640.77

**Application info**

Citroën C Elyse (11/12--)  
 Citroën C3 II (09/09--)  
 Citroën C4 Cactus (09/14--)  
 DS DS 3 (04/15-07/19)  
 Peugeot 2008 I (03/13--)  
 Peugeot 301 (11/12--)

Citroën C3 AIRCROSS II (06/17--)  
 Citroën C3 III (07/16--)  
 Citroën DS3 (11/09-12/16)  
 Opel Crossland X (03/17--)  
 Peugeot 208 I (03/12--)  
 Vauxhall Crossland X (03/17--)

**Ball joint****11-16 010 0018****MBJ0038****Notes**

Front Axle Left  
 Front Axle Right  
 Lower

Required quantity  
 replacement in pairs recommended

2

**References**

Citroën 3640.58  
 Citroën 3640.72  
 Peugeot 3640.69

Citroën 3640.69  
 Peugeot 3640.58  
 Peugeot 3640.72

**Application info**

Citroën C5 III (RD\_, TD\_) (02/08--)  
Peugeot 407 (02/04--)

Citroën C6 (09/05-12/12)  
Peugeot 508 I (11/10--)

**Ball joint****11-16 010 0020****MBJ0039****Notes**

Front Axle Left  
Front Axle Right  
Lower  
with accessories

Flange Hole Diameter [mm] 12  
Required quantity 2  
replacement in pairs recommended

**References**

Peugeot 3640.83

**Application info**

Peugeot 508 I (11/10--)

**Ball joint****11-16 010 0025****MBJ0439****Notes**

Front Axle Left  
Front Axle Right  
with accessories

Required quantity 2  
replacement in pairs recommended

**References**

Citroën 3640.78  
Peugeot 3640.78

DS 3640.78

**Application info**

Citroën C3 III (07/16--)  
DS DS 3 (04/15-07/19)

Citroën DS3 (11/09-12/16)  
Peugeot 208 I (03/12--)



**Ball joint**

11-16 010 0026

MBJ0456

**Notes**

Front Axle Left  
 Front Axle Right  
 Lower  
 for control arm  
 outer

Required quantity  
 replacement in pairs recommended

**References**

Citroën 98 073 060 99  
 Citroën 98 310 885 80  
 GENERAL MOTORS 39188665  
 Opel 39188665  
 Peugeot 96 72 192 480  
 Peugeot 98 17 689 680  
 Peugeot 98 31 088 580  
 Vauxhall 39 18 8665

Citroën 98 176 896 80  
 Citroën 98 317 938 80  
 GENERAL MOTORS 98 310 885 80  
 Opel 98 310 882 80  
 Peugeot 98 07 306 099  
 Peugeot 98 31 088 280  
 Peugeot 98 31 793 880  
 Vauxhall 98 310 885 80

**Application info**

Citroën Berlingo III (06/18--)  
 Opel Combo E (K9) (06/18--)  
 Peugeot 308 II (09/13--)  
 Peugeot Rifter (09/18--)  
 Vauxhall Combo Mk IV (06/18--)

Opel Astra L (10/21--)  
 Peugeot 308 I (09/07--)  
 Peugeot 308 III (07/21--)  
 Vauxhall Astra Mk VIII (10/21--)

**Ball joint**

11-16 010 0027

MBJ0467

**Notes**

Front Axle Left  
 Front Axle Right  
 Lower  
 outer

Required quantity  
 2

Thread Size  
 M14x1,5

replacement in pairs recommended



**References**

Citroën 98 186 575 80  
 Peugeot 98 18 657 580  
 Toyota SU001-A6525

Citroën 98 345 990 80  
 Peugeot 98 34 599 080  
 Toyota SU001-A8260

**Application info**

Citroën Jumpy III (04/16--)  
 Opel Vivaro C (03/19--)  
 Peugeot Traveller (04/16--)  
 Vauxhall Vivaro C (03/19--)

Citroën Spacetourer (04/16--)  
 Peugeot Expert III (04/16--)  
 Toyota Proace II (02/16--)

**Ball joint**

11-16 010 0035

MBJ0513

**Notes**

Front Axle Left  
 Front Axle Right  
 Lower  
 outer  
 Required quantity  
 replacement in pairs recommended



**References**

DS 98 153 962 80

Peugeot 98 15 396 280

**Application info**

DS DS 7 (09/17--)  
 Peugeot 508 II (09/18--)

DS DS 9 (09/20--)

**Ball joint**

11-16 010 3347

MBJ0040

**Notes**

Front Axle Left  
 Front Axle Right  
 Lower  
 Height [mm]  
 Required quantity  
 Thread Size  
 replacement in pairs recommended



**References**

Citroën 3640 28  
 Citroën 3640.71  
 Citroën 96 233 739  
 Peugeot 3640.34

Citroën 3640 34  
 Citroën 95 028 039  
 Peugeot 3640.28  
 Peugeot 3640.71

**Application info**

Citroën C5 I / C5 II (03/01--)  
 Citroën Xantia (03/93-04/03)  
 Peugeot 406 (08/95-02/05)  
 Peugeot 607 (01/00--)

Citroën XM (05/89-10/00)  
 Peugeot 405 (01/87-12/99)  
 Peugeot 605 (06/89-09/99)

**Ball joint****11-16 010 3356****MBJ0041****Notes**

Front Axle Left  
 Front Axle Right  
 Lower

Height [mm] 51  
 Outer Diameter [mm] 37  
 Required quantity 2  
 replacement in pairs recommended

**References**

Citroën 16 144 392 80  
 Citroën 96 093 233  
 Peugeot 3640.36

Citroën 3640.36  
 Peugeot 16 144 392 80

**Application info**

Citroën AX (07/86-12/98)  
 Peugeot 106 (08/91-05/05)

Citroën Saxo (02/96-04/04)

**Ball joint**

11-16 010 4087/HD

MBJ0043HD

**Notes**

Carbon Neutral  
Front Axle Left  
Front Axle Right  
Lower  
with accessories

Required quantity

2

Thread Size

M16x1,5

reinforced version

replacement in pairs recommended

**References**

Citroën 7 567 284

Fiat 7567284

Peugeot 3640.26

**Application info**

Citroën C25 (07/81-07/94)

Fiat Ducato (280) (01/82-09/90)

Fiat Ducato / Talento (290) (03/89-05/94)

Peugeot J5 (280) (09/81-09/90)

Peugeot J5 (290) (09/90-03/94)

**Ball joint**

11-16 010 6909

MBJ0045

**Notes**

Front Axle Left  
Front Axle Right  
Lower  
with accessories

Required quantity

2

replacement in pairs recommended

**References**

Peugeot 3640.30

Peugeot 3640.31

Peugeot 3640.37

Peugeot 3640.44

Peugeot 96 109 681

**Application info**

Peugeot 306 (01/93-10/03)



**Ball joint****116 010 0005****MBJ0048****Notes**

Front Axle Left  
 Front Axle Right  
 Lower  
 with accessories

Required quantity

2

Thread Size

M12x1,5

replacement in pairs recommended

**References**

Audi 8N0 407 365 B

Audi 8N0 407 365 C

Seat 8N0 407 365 B

Seat 8N0 407 365 C

Volkswagen 8N0 407 365 C

**Application info**

Audi A3 I (8L\_) (09/96-09/06)

Audi TT I (8N\_) (10/98-12/06)

Seat Leon I / Toledo II (1M\_) (10/98-06/06)

Volkswagen Golf IV (1J1, 1J5) (08/97-06/14)

Volkswagen New Beetle (1Y7, 9C1, 1C1) (01/98-12/11)

**Ball joint****116 010 0007****MBJ0049****Notes**

Front Axle Left  
 Lower  
 with accessories

Paired article number

116 010 0008 | MBJ0050

Required quantity

1

Thread Size

M12x1,5

replacement in pairs recommended

**References**

Audi 8Z0 407 365 A

Seat 6Q0 407 365 A

Seat 6Q0 407 365 M

Skoda 6Q0 407 365 A

Skoda 6Q0 407 365 M

Volkswagen 5Z0 407 365 B

Volkswagen 6Q0 407 365 A

Volkswagen 6Q0 407 365 D

Volkswagen 6Q0 407 365 F

Volkswagen 6Q0 407 365 M

Volkswagen (SVW) 6Q0 407 365 A

Volkswagen (SVW) 6Q0 407 365 M

**Application info**

Audi A2 (8Z0) (02/00-08/05)  
 Skoda Fabia I (6Y\_) (08/99-03/08)  
 Skoda Roomster (03/06-05/15)  
 Volkswagen Polo (9N\_) (10/01--)

Seat Ibiza III / Cordoba II (6L\_) (02/02-11/09)  
 Skoda Fabia II (54\_) (12/06-12/14)  
 Volkswagen Fox/Lupo (Z51) (08/03--)

**Ball joint****116 010 0008****MBJ0050****Notes**

Front Axle Right  
 Lower  
 with accessories  
 Paired article number 116 010 0007 | MBJ0049  
 Required quantity 1  
 Thread Size M12x1,5  
 replacement in pairs recommended

**References**

Audi 8Z0 407 366 A  
 Seat 6Q0 407 366 M  
 Skoda 6Q0 407 366 M  
 Volkswagen 6Q0 407 366 A  
 Volkswagen 6Q0 407 366 F  
 Volkswagen (SVW) 6Q0 407 366 A

Seat 6Q0 407 366 A  
 Skoda 6Q0 407 366 A  
 Volkswagen 5Z0 407 366 B  
 Volkswagen 6Q0 407 366 D  
 Volkswagen 6Q0 407 366 M  
 Volkswagen (SVW) 6Q0 407 366 M

**Application info**

Audi A2 (8Z0) (02/00-08/05)  
 Skoda Fabia I (6Y\_) (08/99-03/08)  
 Skoda Roomster (03/06-05/15)  
 Volkswagen Polo (9N\_) (10/01--)

Seat Ibiza III / Cordoba II (6L\_) (02/02-11/09)  
 Skoda Fabia II (54\_) (12/06-12/14)  
 Volkswagen Fox/Lupo (Z51) (08/03--)

**Ball joint****116 010 0009****MBJ0051****Notes**

Front Axle Left  
 Front Axle Right  
 Lower  
 with accessories  
 Length [mm] 33  
 Required quantity 2  
 Thread Size M14x1,5  
 replacement in pairs recommended



**References**

Ford 1 111 156

Ford 95VW-3395-AA

Seat 7M3 407 365 A

Volkswagen 7M0 407 365 A

Volkswagen 7M3 407 365 C

Ford 7 200 946

Ford YM21-3395-BA

Seat 7M3 407 365 C

Volkswagen 7M3 407 365 A

**Application info**

Ford Galaxy I (03/95-05/06)

Volkswagen Sharan (7M) (05/95-03/10)

Seat Alhambra I (7V8, 7V9) (03/96-03/10)

**Ball joint**

116 010 0012/HD

MBJ0052HD

**Notes**

Carbon Neutral  
Front Axle Left  
Front Axle Right  
Lower  
with accessories

Required quantity

2

Thread Size

M14x1,5

reinforced version

replacement in pairs recommended



**References**

Volkswagen 7E0 407 361

Volkswagen 7H0 407 361

Volkswagen 7E0 407 361 A

Volkswagen 7H0 407 361 A

**Application info**

Volkswagen Multivan T7 (STM, STN) (08/21--)

Volkswagen Transporter VI (04/15--)

Volkswagen Transporter V (04/03-08/15)

**Ball joint**

116 010 0013/HD

MBJ0053HD

**Notes**

Carbon Neutral  
Front Axle Left  
Front Axle Right  
Lower  
with accessories

Required quantity

2

Thread Size

M14x1,5

reinforced version

replacement in pairs recommended





**References**

Volkswagen 7E8 407 361  
 Volkswagen 7H8 407 361 A

Volkswagen 7H8 407 361

**Application info**

Volkswagen Transporter V (04/03-08/15)

Volkswagen Transporter VI (04/15--)

**Ball joint**

116 010 0015

MBJ0054

**Notes**

Front Axle Left  
 Lower  
 with accessories  
 Paired article number 116 010 0016 | MBJ0055  
 Required quantity 1  
 Thread Size M12x1,5  
 replacement in pairs recommended



**References**

Audi 1K0 407 365 B  
 Audi 1K0 407 365 E  
 Skoda 1K0 407 365 C  
 Volkswagen 1K0 407 365 B  
 Volkswagen 1K0 407 365 E  
 Volkswagen (SVW) 1K0 407 365 C

Audi 1K0 407 365 C  
 Seat 1K0 407 365 C  
 Skoda (SVW) 1K0 407 365 C  
 Volkswagen 1K0 407 365 C  
 Volkswagen (FAW) 1KD 407 365  
 Volkswagen (SVW) 1KD 407 365

**Application info**

Audi A3 II (8P\_) (05/03-12/15)  
 Seat Leon II / Toledo III / Altea (1P\_ ,5P\_) (03/04--)  
 Skoda Superb II (3T) (03/08-05/15)  
 Volkswagen Beetle (5C1) (04/11-07/19)  
 Volkswagen Caddy IV (SA\_) (05/15--)  
 Volkswagen Golf V (1K1, 1K5, 5M1) (10/03-08/14)  
 Volkswagen Jetta III (1K2) (09/04-12/13)  
 Volkswagen Passat (A32) (01/11--)  
 Volkswagen Tiguan I (5N) (09/07-07/18)

Audi Q3 I (8U\_) (06/11-12/18)  
 Skoda Octavia II (1Z\_) (02/04-06/13)  
 Skoda Yeti (5L) (05/09-12/17)  
 Volkswagen Caddy III (2KA, 2KB) (03/04-05/15)  
 Volkswagen Eos (03/06-08/15)  
 Volkswagen Golf VI (5K1, 517, AJ5) (10/08-05/16)  
 Volkswagen Jetta IV (162) (01/08--)  
 Volkswagen Scirocco III (137) (05/08-11/17)  
 Volkswagen Touran I ( 1T1/2/3) (02/03-05/15)

**Ball joint****116 010 0016****MBJ0055****Notes**

Front Axle Right  
Lower  
with accessories  
Paired article number 116 010 0015 | MBJ0054  
Required quantity 1  
Thread Size M12x1,5  
replacement in pairs recommended

**References**

Audi 1K0 407 366 B  
Audi 1K0 407 366 E  
Skoda 1K0 407 366 C  
Volkswagen 1K0 407 366 B  
Volkswagen 1K0 407 366 E  
Volkswagen (SVW) 1K0 407 366 C

Audi 1K0 407 366 C  
Seat 1K0 407 366 C  
Skoda (SVW) 1K0 407 366 C  
Volkswagen 1K0 407 366 C  
Volkswagen (FAW) 1KD 407 366  
Volkswagen (SVW) 1KD 407 366

**Application info**

Audi A3 II (8P\_) (05/03-12/15)  
Seat Leon II / Toledo III / Altea (1P\_ ,5P\_) (03/04--)  
Skoda Superb II (3T) (03/08-05/15)  
Volkswagen Beetle (5C1) (04/11-07/19)  
Volkswagen Caddy IV (SA\_) (05/15--)  
Volkswagen Golf V (1K1, 1K5, 5M1) (10/03-08/14)  
Volkswagen Jetta III (1K2) (09/04-12/13)  
Volkswagen Passat (A32) (01/11--)  
Volkswagen Tiguan I (5N) (09/07-07/18)  
Audi Q3 I (8U\_) (06/11-12/18)  
Skoda Octavia II (1Z\_) (02/04-06/13)  
Skoda Yeti (5L) (05/09-12/17)  
Volkswagen Caddy III (2KA, 2KB) (03/04-05/15)  
Volkswagen Eos (03/06-08/15)  
Volkswagen Golf VI (5K1, 517, AJ5) (10/08-05/16)  
Volkswagen Jetta IV (162) (01/08--)  
Volkswagen Scirocco III (137) (05/08-11/17)  
Volkswagen Touran I (1T1/2/3) (02/03-05/15)

**Ball joint****116 010 0017****MBJ0056****Notes**

Front Axle Left  
Lower  
with accessories  
Paired article number 116 010 0018 | MBJ0057  
Required quantity 1  
Thread Size M12x1,5  
replacement in pairs recommended



**References**

- |                          |                          |
|--------------------------|--------------------------|
| Audi 3C0 407 365 A       | Audi 3C0 407 365 B       |
| Audi 5QD 407 365         | Audi (FAW) 3C0 407 365 B |
| Seat 3C0 407 365 A       | Seat 3C0 407 365 B       |
| Skoda 3C0 407 365 B      | Volkswagen 3C0 407 365 A |
| Volkswagen 3C0 407 365 B | Volkswagen 5QM 407 365   |

**Application info**

- |  |  |
|--|--|
| Audi A3 II (8P_) (05/03-12/15)             | Audi A3 III (8V_) (04/12--)                            |
| Audi A3 IV (8Y_) (11/19--)                 | Audi Q2 (06/16--)                                      |
| Audi Q3 I (8U_) (06/11-12/18)              | Audi Q3 II (F3_) (07/18--)                             |
| CUPRA ATECA (KH7_KHP) (09/18--)            | Seat Alhambra II (710) (06/10--)                       |
| Seat Ateca (04/16--)                       | Seat Leon II / Toledo III / Altea (1P_ ,5P_) (03/04--) |
| Seat Leon III (5F_) (09/12--)              | Seat Tarraco (09/18--)                                 |
| Skoda Karoq (07/17--)                      | Skoda Kodiaq I (10/16--)                               |
| Skoda Octavia III (5E_) (11/12--)          | Skoda Octavia IV (NX_) (11/19--)                       |
| Skoda Superb III (3V_) (03/15--)           | Volkswagen Arteon (03/17--)                            |
| Volkswagen CC (11/11-12/16)                | Volkswagen Golf VII (5G1,BA5) (08/12--)                |
| Volkswagen Golf VIII (CB1) (07/19--)       | Volkswagen Jetta VII (BU3 ) (12/17--)                  |
| Volkswagen Passat (362, 365) (08/10-12/15) | Volkswagen Passat (3C_) (03/05-01/12)                  |
| Volkswagen Passat (B8) (08/14--)           | Volkswagen Sharan (7N) (05/10--)                       |
| Volkswagen T-Roc (A11) (07/17--)           | Volkswagen Taos (CL1, CQ1) (10/20--)                   |
| Volkswagen Tiguan II (AD1, BW2 ) (01/16--) | Volkswagen Touran II (5T1 ) (05/15--)                  |

**Ball joint**

116 010 0018

MBJ0057

**Notes**

Front Axle Right  
 Lower  
 with accessories  
 Paired article number 116 010 0017 | MBJ0056  
 Required quantity 1  
 Thread Size M12x1,5  
 replacement in pairs recommended



**References**

- |                          |                          |
|--------------------------|--------------------------|
| Audi 3C0 407 366 A       | Audi 3C0 407 366 B       |
| Audi 5QD 407 366         | Audi (FAW) 3C0 407 366 B |
| Seat 3C0 407 366 A       | Seat 3C0 407 366 B       |
| Skoda 3C0 407 366 B      | Volkswagen 3C0 407 366 A |
| Volkswagen 3C0 407 366 B | Volkswagen 5QM 407 366   |

**Application info**

Audi A3 II (8P_) (05/03-12/15)	Audi A3 III (8V_) (04/12--)
Audi A3 IV (8Y_) (11/19--)	Audi Q2 (06/16--)
Audi Q3 I (8U_) (06/11-12/18)	Audi Q3 II (F3_) (07/18--)
CUPRA ATECA (KH7_KHP) (09/18--)	Seat Alhambra II (710) (06/10--)
Seat Ateca (04/16--)	Seat Leon II / Toledo III / Altea (1P_ ,5P_) (03/04--)
Seat Leon III (5F_) (09/12--)	Seat Tarraco (09/18--)
Skoda Karoq (07/17--)	Skoda Kodiaq I (10/16--)
Skoda Octavia III (5E_) (11/12--)	Skoda Octavia IV (NX_) (11/19--)
Skoda Superb III (3V_) (03/15--)	Volkswagen Arteon (03/17--)
Volkswagen CC (11/11-12/16)	Volkswagen Golf VII (5G1,BA5) (08/12--)
Volkswagen Golf VIII (CB1) (07/19--)	Volkswagen Jetta VII (BU3) (12/17--)
Volkswagen Passat (362, 365) (08/10-12/15)	Volkswagen Passat (3C_) (03/05-01/12)
Volkswagen Passat (B8) (08/14--)	Volkswagen Sharan (7N) (05/10--)
Volkswagen T-Roc (A11) (07/17--)	Volkswagen Taos (CL1, CQ1) (10/20--)
Volkswagen Tiguan II (AD1, BW2) (01/16--)	Volkswagen Touran II (5T1) (05/15--)

**Ball joint****116 010 0019****MBJ0058****Notes**

Front Axle Left  
 Front Axle Right  
 Lower  
 Cone Size [mm] 13.8  
 Height [mm] 109  
 Outer Diameter [mm] 42  
 Required quantity 2  
 Thread Size M12x1,5



replacement in pairs recommended

**References**

Audi 8K0 407 689 D	Audi 8K0 407 689 E
Audi 8K0 407 689 F	Audi 8K0 407 689 G
Audi (FAW) 8K0 407 689 E	Audi (FAW) 8K0 407 689 F
Audi (FAW) 8K0 407 689 G	

**Application info**

Audi A4 IV (8K_) (08/07-05/16)	Audi A5 I (8F_ , 8T_) (06/07-01/17)
Audi A6 IV (4G2, 4G5, C7) (11/10-09/18)	Audi A7 I Sportback (4G_) (07/10-05/18)
Audi Q5 I (8R_) (11/08-12/17)	

Ball joint		116 010 0022	MBJ0059
<p><b>Notes</b></p> <p>Front Axle Left with accessories</p> <p>Paired article number 116 010 0023   MBJ0060</p> <p>Required quantity 1</p> <p>Thread Size M12x1,5</p> <p>replacement in pairs recommended</p>			
<p><b>References</b></p> <p>Audi 8J0 407 365</p>			
<p><b>Application info</b></p> <p>Audi TT II (8J_) (07/06-01/15)</p> <p>Audi TT III (8S_) (07/14--)</p>			
Ball joint		116 010 0023	MBJ0060
<p><b>Notes</b></p> <p>Front Axle Right with accessories</p> <p>Paired article number 116 010 0022   MBJ0059</p> <p>Required quantity 1</p> <p>Thread Size M12x1,5</p> <p>replacement in pairs recommended</p>			
<p><b>References</b></p> <p>Audi 8J0 407 366</p>			
<p><b>Application info</b></p> <p>Audi TT II (8J_) (07/06-01/15)</p> <p>Audi TT III (8S_) (07/14--)</p>			

**Ball joint**

116 010 0024

MBJ0061

**Notes**

Front Axle Left  
Lower  
outer  
with accessories  
Paired article number 116 010 0025 | MBJ0062  
Required quantity 1  
Thread Size M12x1,5  
replacement in pairs recommended



**References**

- |                          |                          |
|--------------------------|--------------------------|
| Audi 6R0 407 365         | Audi 6R0 407 365 A       |
| Audi 6R0 407 365 B       | Seat 6R0 407 365         |
| Seat 6R0 407 365 A       | Seat 6R0 407 365 B       |
| Skoda 6R0 407 365        | Skoda 6R0 407 365 A      |
| Skoda 6R0 407 365 B      | Volkswagen 6R0 407 365   |
| Volkswagen 6R0 407 365 A | Volkswagen 6R0 407 365 B |

**Application info**

- |   |   |
|---|---|
| Audi A1 I (8X_) (05/10-10/18)             | Seat Ibiza III / Cordoba II (6L_) (02/02-11/09) |
| Seat Ibiza IV (6J_ ,6P_) (03/08-12/18)    | Seat Mii (10/11--)                              |
| Seat Toledo IV (KG3) (07/12-04/19)        | Skoda Citigo (10/11--)                          |
| Skoda Fabia II (54_) (12/06-12/14)        | Skoda Fabia III (NJ_) (08/14--)                 |
| Skoda Rapid II (N_) (07/12-12/19)         | Skoda Roomster (03/06-05/15)                    |
| Volkswagen Polo (6R_) (03/09--)           | Volkswagen Polo (9N_) (10/01--)                 |
| Volkswagen Polo Vivo (6R1, 6RS) (07/17--) | Volkswagen UP (08/11--)                         |

**Ball joint**

116 010 0025

MBJ0062

**Notes**

Front Axle Right  
Lower  
outer  
with accessories  
Paired article number 116 010 0024 | MBJ0061  
Required quantity 1  
Thread Size M12x1,5  
replacement in pairs recommended



**References**

Audi 6R0 407 366	Audi 6R0 407 366 A
Audi 6R0 407 366 B	Seat 6R0 407 366
Seat 6R0 407 366 A	Seat 6R0 407 366 B
Skoda 6R0 407 366	Skoda 6R0 407 366 A
Skoda 6R0 407 366 B	Volkswagen 6R0 407 366
Volkswagen 6R0 407 366 A	Volkswagen 6R0 407 366 B

**Application info**

Audi A1 I (8X_) (05/10-10/18)	Seat Ibiza III / Cordoba II (6L_) (02/02-11/09)
Seat Ibiza IV (6J_ ,6P_) (03/08-12/18)	Seat Mii (10/11--)
Seat Toledo IV (KG3) (07/12-04/19)	Skoda Citigo (10/11--)
Skoda Fabia II (54_) (12/06-12/14)	Skoda Fabia III (NJ_) (08/14--)
Skoda Rapid II (N_) (07/12-12/19)	Skoda Roomster (03/06-05/15)
Volkswagen Polo (6R_) (03/09--)	Volkswagen Polo (9N_) (10/01--)
Volkswagen Polo Vivo (6R1, 6RS) (07/17--)	Volkswagen UP (08/11--)

**Ball joint****116 010 0033****MBJ0063****Notes**

Front Axle Left  
with accessories  
Paired article number  
116 010 0034 | MBJ0064  
Required quantity  
1  
Thread Size  
M12x1,5

replacement in pairs recommended

**References**

Audi 5Q0 407 365 A	Audi (FAW) 5Q0 407 365 A
Seat 5Q0 407 365 A	Skoda 5Q0 407 365 A
Skoda (SVW) 5Q0 407 365 A	Volkswagen 5Q0 407 365 A

**Application info**

Audi A1 II (GB_) (07/18--)	Audi A3 III (8V_) (04/12--)
Audi Q2 (06/16--)	Seat Arona (KJ7) (07/17--)
Seat Ibiza V (KJ1) (01/17--)	Seat Leon III (5F_) (09/12--)
Skoda Fabia IV (PJ3) (06/21--)	Skoda Kamiq (07/19--)
Skoda Octavia III (5E_) (11/12--)	Skoda Scala (02/19--)
Volkswagen Caddy IV (SA_) (05/15--)	Volkswagen Golf VII (5G1,BA5) (08/12--)
Volkswagen Golf VIII (CB1) (07/19--)	Volkswagen Nivus / Taigo (11/21--)
Volkswagen Polo (AW1) (06/17--)	Volkswagen T-Cross (12/18--)
Volkswagen T-Roc (A11) (07/17--)	Volkswagen Taos (CL1, CQ1) (10/20--)



**Ball joint**

116 010 0034

MBJ0064

**Notes**

Front Axle Right  
with accessories

Paired article number 116 010 0033 | MBJ0063

Required quantity 1

Thread Size M12x1,5

replacement in pairs recommended



**References**

Audi 5Q0 407 366 A Audi (FAW) 5Q0 407 366 A

Seat 5Q0 407 366 A Skoda 5Q0 407 366 A

Skoda (SVW) 5Q0 407 366 A Volkswagen 5Q0 407 366 A

**Application info**

Audi A1 II (GB\_) (07/18--)

Audi Q2 (06/16--)

Seat Ibiza V (KJ1) (01/17--)

Skoda Fabia IV (PJ3) (06/21--)

Skoda Octavia III (5E\_) (11/12--)

Volkswagen Caddy IV (SA\_) (05/15--)

Volkswagen Golf VIII (CB1) (07/19--)

Volkswagen Polo (AW1) (06/17--)

Volkswagen T-Roc (A11) (07/17--)

Audi A3 III (8V\_) (04/12--)

Seat Arona (KJ7) (07/17--)

Seat Leon III (5F\_) (09/12--)

Skoda Kamiq (07/19--)

Skoda Scala (02/19--)

Volkswagen Golf VII (5G1,BA5) (08/12--)

Volkswagen Nivus / Taigo (11/21--)

Volkswagen T-Cross (12/18--)

Volkswagen Taos (CL1, CQ1) (10/20--)

**Ball joint**

116 010 0035

MBJ0303

**Notes**

Front Axle Left  
Front Axle Right  
Lower

Outer Diameter [mm] 49

Required quantity 2

Thread Size M14x1,5

replacement in pairs recommended



**References**

Volkswagen 2H0 407 151 A Volkswagen 2H0 407 152 A



**Application info**

Volkswagen Amarok I (09/10--)

**Ball joint**

116 010 0036

MBJ0306

**Notes**

Front Axle Left  
 Front Axle Right  
 Upper

Outer Diameter [mm]

45

Required quantity

2

Thread Size

M12x1,5

replacement in pairs recommended

**References**

Volkswagen 2H0 407 021 B

Volkswagen 2H0 407 022 B

**Application info**

Volkswagen Amarok I (09/10--)

**Ball joint**

116 010 0037

MBJ0430

**Notes**

Front Axle Left  
 Front Axle Right  
 Lower  
 with accessories

Required quantity

2

Thread Size

M14x1,5

replacement in pairs recommended

**References**

Volkswagen 7E0 407 361

Volkswagen 7E0 407 361 A

Volkswagen 7H0 407 361

Volkswagen 7H0 407 361 A

**Application info**

Volkswagen Transporter V (04/03-08/15)

Volkswagen Transporter VI (04/15--)

**Ball joint** 116 010 0038 MBJ0431

**Notes**

Front Axle Left  
 Front Axle Right  
 Upper  
 with accessories

Height [mm] 106  
 Outer Diameter [mm] 46  
 Required quantity 2  
 Thread Size M16x1,5  
 replacement in pairs recommended



**References**

Volkswagen 701 407 187 Volkswagen 701 407 187 A  
 Volkswagen 701 407 187 B

**Application info**

Volkswagen Transporter IV (07/90-06/03)

**Ball joint** 116 010 0039 MBJ0432

**Notes**

Front Axle Left  
 Lower  
 with accessories

Paired article number 116 010 0040 | MBJ0433  
 Required quantity 1  
 Thread Size M12x1,5  
 replacement in pairs recommended



**References**

Audi 1J0 407 365 A	Audi 1J0 407 365 C
Audi 1J0 407 365 D	Audi 1J0 407 365 J
Seat 1J0 407 365 C	Seat 1J0 407 365 H
Seat 1J0 407 365 J	Skoda 1J0 407 365 C
Skoda 1J0 407 365 D	Skoda 1J0 407 365 H
Skoda 1J0 407 365 J	Volkswagen 1J0 407 365 A
Volkswagen 1J0 407 365 C	Volkswagen 1J0 407 365 D
Volkswagen 1J0 407 365 H	Volkswagen 1J0 407 365 J
Volkswagen (FAW) 1J0 407 365 C	Volkswagen (SVW) 1JD 407 365

**Application info**

Audi A3 I (8L\_) (09/96-09/06)

Skoda Octavia I (1U\_) (09/96-12/10)

Volkswagen Bora V (Mex) (01/07--)

Volkswagen Golf VI (5K1, 517, AJ5) (10/08-05/16)

Volkswagen New Beetle (1Y7, 9C1, 1C1) (01/98-12/11)

Seat Leon I / Toledo II (1M\_) (10/98-06/06)

Volkswagen Bora (1J2, 1J6) (10/98-12/13)

Volkswagen Golf IV (1J1, 1J5) (08/97-06/14)

Volkswagen Jetta City (09/06-12/09)

**Ball joint****116 010 0040****MBJ0433****Notes**

Front Axle Right

Lower

with accessories

Paired article number

116 010 0039 | MBJ0432

Required quantity

1

Thread Size

M12x1,5

replacement in pairs recommended

**References**

Audi 1J0 407 366 A

Audi 1J0 407 366 D

Seat 1J0 407 366 C

Seat 1J0 407 366 J

Skoda 1J0 407 366 D

Skoda 1J0 407 366 J

Volkswagen 1J0 407 366 A

Volkswagen 1J0 407 366 D

Volkswagen 1J0 407 366 J

Volkswagen (SVW) 1JD 407 366

Audi 1J0 407 366 C

Audi 1J0 407 366 J

Seat 1J0 407 366 H

Skoda 1J0 407 366 C

Skoda 1J0 407 366 H

Skoda 1J0 422 366 C

Volkswagen 1J0 407 366 C

Volkswagen 1J0 407 366 H

Volkswagen (FAW) 1J0 407 366 C

**Application info**

Audi A3 I (8L\_) (09/96-09/06)

Skoda Octavia I (1U\_) (09/96-12/10)

Volkswagen Bora V (Mex) (01/07--)

Volkswagen Golf VI (5K1, 517, AJ5) (10/08-05/16)



Volkswagen New Beetle (1Y7, 9C1, 1C1) (01/98-12/11)

Seat Leon I / Toledo II (1M\_) (10/98-06/06)

Volkswagen Bora (1J2, 1J6) (10/98-12/13)

Volkswagen Golf IV (1J1, 1J5) (08/97-06/14)

Volkswagen Jetta City (09/06-12/09)

Ball joint		116 010 0041	MBJ0449
<b>Notes</b>  Front Axle Left Front Axle Right Lower outer Required quantity 2 Thread Size M14x1,5 replacement in pairs recommended			
<b>References</b> Audi 4H0 407 689 Audi 4H0 407 689 A			
<b>Application info</b> Audi A8 III (4H_) (11/09-01/18)			
Ball joint		116 010 0043	MBJ0458
<b>Notes</b>  Front Axle Left Front Axle Right Outer Diameter [mm] 54 Required quantity 2 Thread Size M14x1,5 replacement in pairs recommended			
<b>References</b> MAN 2N0407361A MAN 65.43316-0006 Volkswagen 2N0 407 361 A			
<b>Application info</b> MAN TGE (11/16--) Volkswagen Crafter II (SY_) (09/16--)			

**Ball joint****116 010 0044****MBJ0464****Notes**

Front Axle Left  
 Front Axle Right  
 Lower

Cone Size [mm] 24  
 Outer Diameter [mm] 46  
 Required quantity 2  
 Thread Size M14x1,5  
 replacement in pairs recommended

**References**

Audi 80A 407 689 B

Audi 80A 407 689 C

**Application info**

Audi A6 V (C8, 4A2) (02/18--)

Audi A7 II Sportback (4K\_) (10/17--)

Audi Q5 II (FY\_) (05/16--)

**Ball joint****116 010 0045/HD****MBJ0479HD****Notes**

Carbon Neutral  
 Front Axle Left  
 Front Axle Right  
 for control arm

Required quantity 2  
 Thread Size M14x1,5  
 reinforced version  
 replacement in pairs recommended

**References**

Audi 4M0 407 689 B

Audi 4M0 407 689 C

Porsche 958 407 689 C

Volkswagen 4M0 407 689 C

**Application info**

Audi A8 IV (4N\_) (06/17--)

Audi E-TRON (GE\_) (09/18--)



Audi Q7 II (4M\_) (01/15--)





Audi Q8 (4MN) (02/18--)

Audi Q8 E-TRON (11/22--)

Porsche Cayenne III (9Y\_) (05/17--)

Volkswagen Touareg III (CR7) (11/17--)

Ball joint		116 010 0052	MBJ0510
<p><b>Notes</b></p> <p>Front Axle Left Lower outer</p> <p>Paired article number 116 010 0053   MBJ0511</p> <p>Required quantity 1</p> <p>Thread Size M12x1,5</p> <p>replacement in pairs recommended</p>			
<p><b>References</b></p> <p>Volkswagen 3QF 407 365</p>			
<p><b>Application info</b></p> <p>Volkswagen Atlas (12/16--)</p>			
Ball joint		116 010 0053	MBJ0511
<p><b>Notes</b></p> <p>Front Axle Right Lower outer</p> <p>Paired article number 116 010 0052   MBJ0510</p> <p>Required quantity 1</p> <p>Thread Size M12x1,5</p> <p>replacement in pairs recommended</p>			
<p><b>References</b></p> <p>Volkswagen 3QF 407 366</p>			
<p><b>Application info</b></p> <p>Volkswagen Atlas (12/16--)</p>			

Ball joint		116 010 0600	MBJ0065
<b>Notes</b>  Front Axle Left Front Axle Right Lower Height [mm] 39 Outer Diameter [mm] 38.4 Required quantity 2 Thread Size M12x1,5 replacement in pairs recommended		 	
<b>References</b> Volkswagen 181 405 371 C			
<b>Application info</b> Volkswagen 181 (09/69-11/83)			
Ball joint		116 010 0633	MBJ0069
<b>Notes</b>  Front Axle Left Front Axle Right Lower Height [mm] 81 Outer Diameter [mm] 47 Required quantity 2 Thread Size M20x1,5 replacement in pairs recommended		 	
<b>References</b> Volkswagen 311 405 371 Volkswagen 311 405 371 C Volkswagen 311 405 371 A			
<b>Application info</b> Volkswagen 1500,1600 (04/61-03/75)			

**Ball joint**

116 010 0657/HD

MBJ0070HD

**Notes**

Carbon Neutral  
Front Axle Left  
Front Axle Right

Lower

Upper

Outer Diameter [mm]

48.6

Required quantity

4

Thread Size

M18x1,5

reinforced version

replacement in pairs recommended

**References**

Volkswagen 211 405 371 A

Volkswagen 211 405 371 B

**Application info**

Volkswagen Transporter II (08/67-09/79)

**Ball joint**

116 010 0657

MBJ0070

**Notes**

Front Axle Left  
Front Axle Right

Lower

Upper

Height [mm]

118

Outer Diameter [mm]

48.3

Required quantity

2

Thread Size

M18x1,5 mm

replacement in pairs recommended

**References**

Volkswagen 211 405 371 A

Volkswagen 211 405 371 B

**Application info**

Volkswagen Transporter II (08/67-09/79)



**Ball joint**

116 010 3222

MBJ0072

**Notes**

Front Axle Left  
 Front Axle Right  
 Lower

Height [mm] 66  
 Outer Diameter [mm] 38  
 Required quantity 2  
 replacement in pairs recommended

**References**

Volkswagen 133 407 361

**Application info**

Volkswagen Käfer / Karmann Ghia (12/47-08/03)

**Ball joint**

116 010 3254

MBJ0075

**Notes**

Front Axle Left  
 Front Axle Right  
 Lower  
 with accessories

Required quantity 2  
 replacement in pairs recommended

**References**

Porsche 171 407 365 G

Volkswagen 171 407 365 G

Volkswagen 171 407 365 F

**Application info**

Porsche 924 (11/75-08/89)

Volkswagen Caddy I (14) (08/79-07/92)





Volkswagen Jetta I (16) (08/78-12/87)

Volkswagen Scirocco II (53B) (08/80-07/92)

Porsche 944 (06/81-07/91)

Volkswagen Golf I (17, 155) (04/74-08/93)

Volkswagen Scirocco I (53) (02/74-07/80)

Ball joint		116 010 3269/HD	MBJ0076HD
<b>Notes</b>  Carbon Neutral Front Axle Left Front Axle Right Lower  Outer Diameter [mm] 48 Required quantity 2 Thread Size M18x1,5 reinforced version replacement in pairs recommended		 	
<b>References</b> Volkswagen 251 407 187 Volkswagen 251 407 187 B		Volkswagen 251 407 187 A	
<b>Application info</b> Volkswagen Transporter III (05/79-12/02)			
Ball joint		116 010 3270	MBJ0077
<b>Notes</b>  Front Axle Left Front Axle Right Upper with accessories  Length [mm] 18.5 Required quantity 2 Thread Size M16x1,5 replacement in pairs recommended		 	
<b>References</b> Volkswagen 251 407 361			
<b>Application info</b> Volkswagen Transporter III (05/79-12/02)			

<b>Ball joint</b>	<b>116 010 3270/HD</b>	<b>MBJ0077HD</b>
-------------------	------------------------	------------------

<p><b>Notes</b></p> <p>Carbon Neutral Front Axle Left Front Axle Right Upper with accessories</p> <p>Required quantity 2 Thread Size M16x1,5 reinforced version replacement in pairs recommended</p>	
--	---

<p><b>References</b></p> <p>Volkswagen 251 407 361</p>
--

<p><b>Application info</b></p> <p>Volkswagen Transporter III (05/79-12/02)</p>
--

<b>Ball joint</b>	<b>116 010 3915</b>	<b>MBJ0078</b>
-------------------	---------------------	----------------

<p><b>Notes</b></p> <p>Front Axle Right Lower for vehicles without power steering with accessories</p> <p>Cone Size [mm] 17 Length [mm] 42 Paired article number 116 010 3916   MBJ0079 Required quantity 1 replacement in pairs recommended</p>	
--	---

<p><b>References</b></p> <p>Audi 855 407 366</p>
--

<p><b>Application info</b></p> <p>Audi 80/90 (81, 85, B2) (08/78-10/88)</p>	<p>Audi 80/90 (89, 89Q, 8A, B3) (06/86-12/96)</p>
---	---

**Ball joint**

116 010 3916

MBJ0079

**Notes**

Front Axle Left  
Lower  
for vehicles without power steering  
with accessories

Cone Size [mm]

17

Length [mm]

42

Paired article number

116 010 3915 | MBJ0078

Required quantity

1

replacement in pairs recommended

**References**

Audi 855 407 365

**Application info**

Audi 80/90 (81, 85, B2) (08/78-10/88)

Audi 80/90 (89, 89Q, 8A, B3) (06/86-12/96)

**Ball joint**

116 010 3917

MBJ0080

**Notes**

Front Axle Left  
Lower  
for vehicles with power steering  
with accessories

Length [mm]

51

Paired article number

116 010 3918 | MBJ0081

Required quantity

1

replacement in pairs recommended

**References**

Audi 855 407 365 A

Volkswagen 855 407 365 A

Volkswagen 855 407 365 B



**Application info**



Audi 80/90 (81, 85, B2) (08/78-10/88)



Audi 80/90 (85) (07/80-07/91)



Audi 80/90 (89, 89Q, 8A, B3) (06/86-12/96)

Volkswagen Passat (32B) (09/79-06/89)



Ball joint		116 010 3918	MBJ0081
<p><b>Notes</b></p> <p>Front Axle Right Lower for vehicles with power steering with accessories</p> <p>Length [mm] 51</p> <p>Paired article number 116 010 3917   MBJ0080</p> <p>Required quantity 1</p> <p>replacement in pairs recommended</p>			
<p><b>References</b></p> <p>Audi 855 407 366 A Volkswagen 855 407 366 A</p> <p>Volkswagen 855 407 366 B</p>			
<p><b>Application info</b></p> <p>Audi 80/90 (81, 85, B2) (08/78-10/88) Audi 80/90 (85) (07/80-07/91)</p> <p>Audi 80/90 (89, 89Q, 8A, B3) (06/86-12/96) Volkswagen Passat (32B) (09/79-06/89)</p>			
Ball joint		116 010 7001/HD	MBJ0082HD
<p><b>Notes</b></p> <p>Carbon Neutral Front Axle Left Front Axle Right Lower with accessories</p> <p>Required quantity 2</p> <p>Thread Size M16x1,5</p> <p>reinforced version</p> <p>replacement in pairs recommended</p>			
<p><b>References</b></p> <p>Volkswagen 7D0 407 361</p>			
<p><b>Application info</b></p> <p>Volkswagen Transporter IV (07/90-06/03)</p>			

Ball joint		116 010 7108	MBJ0083
<p><b>Notes</b></p> <p>Front Axle Left Front Axle Right Lower with accessories</p> <p>Required quantity 2 replacement in pairs recommended</p>			
<p><b>References</b></p> <p>Seat 191 407 365 Volkswagen 191 407 365 A</p>		<p>Volkswagen 191 407 365 Volkswagen 191 407 365 B</p>	
<p><b>Application info</b></p> <p>Volkswagen Golf II (19E) (08/83-12/92)</p>		<p>Volkswagen Jetta II (19E) (08/83-12/92)</p>	
Ball joint		116 010 7154	MBJ0084
<p><b>Notes</b></p> <p>Front Axle Left Front Axle Right Lower with accessories</p> <p>Required quantity 2 replacement in pairs recommended</p>			
<p><b>References</b></p> <p>Seat 357 407 365 Volkswagen 357 407 365</p>		<p>Seat 357 407 365 S Volkswagen 357 407 365 A</p>	
<p><b>Application info</b></p> <p>Seat Ibiza II / Cordoba I / Inca (6K_) (02/93-11/03) Volkswagen Caddy II (9K9, 9K9B, 9U7) (11/95-06/09) Volkswagen Golf II (19E) (08/83-12/92) Volkswagen Jetta II (19E) (08/83-12/92) Volkswagen Polo (6K_) (01/95-11/09) Volkswagen Vento (11/91-09/98)</p>		<p>Seat Toledo I (1L_) (01/91-10/99) Volkswagen Corrado (53I) (08/87-12/95) Volkswagen Golf III (1H1, 1H5, 1E7) (10/89-12/02) Volkswagen Passat (35I) (02/88-12/97) Volkswagen Polo Playa (01/95-11/09)</p>	

Ball joint		116 010 7175	MBJ0091
<p><b>Notes</b></p> <p>Front Axle Left Lower for vehicles with power steering with accessories</p> <p>Cone Size [mm] 19 Length [mm] 48 Paired article number 116 010 7177   MBJ0092 Required quantity 1 replacement in pairs recommended</p>			
<p><b>References</b></p> <p>Audi 895 407 365</p>		<p>Audi 8A0 407 365</p>	
<p><b>Application info</b></p> <p>Audi 80 (8C, 8G7, B4) (05/91-08/00)</p>		<p>Audi 80/90 (89, 89Q, 8A, B3) (06/86-12/96)</p>	
Ball joint		116 010 7177	MBJ0092
<p><b>Notes</b></p> <p>Front Axle Right Lower for vehicles with power steering with accessories</p> <p>Cone Size [mm] 19 Length [mm] 48 Paired article number 116 010 7175   MBJ0091 Required quantity 1 replacement in pairs recommended</p>			
<p><b>References</b></p> <p>Audi 895 407 366</p>		<p>Audi 8A0 407 366</p>	
<p><b>Application info</b></p> <p>Audi 80 (8C, 8G7, B4) (05/91-08/00)</p>		<p>Audi 80/90 (89, 89Q, 8A, B3) (06/86-12/96)</p>	

Ball joint		116 010 7184	MBJ0093
<b>Notes</b>  Front Axle Left Front Axle Right Lower with accessories  Required quantity 2 Thread Size M12x1,5 replacement in pairs recommended			
<b>References</b> Seat 1H0 407 365 Volkswagen 1H0 407 365 A		Volkswagen 1H0 407 365	
<b>Application info</b> Seat Toledo I (1L_) (01/91-10/99) Volkswagen Golf III (1H1, 1H5, 1E7) (10/89-12/02) Volkswagen Vento (11/91-09/98)		Volkswagen Corrado (53I) (08/87-12/95) Volkswagen Passat (35I) (02/88-12/97)	
Ball joint		116 010 7192/HD	MBJ0094HD
<b>Notes</b>  Carbon Neutral Front Axle Left Front Axle Right Upper with accessories  Height [mm] 106 Outer Diameter [mm] 46 Required quantity 2 Thread Size M16x1,5 reinforced version replacement in pairs recommended			
<b>References</b> Volkswagen 701 407 187 Volkswagen 701 407 187 B		Volkswagen 701 407 187 A	
<b>Application info</b> Volkswagen Transporter IV (07/90-06/03)			



Ball joint		116 010 7193	MBJ0095
<b>Notes</b>  Front Axle Left Front Axle Right Lower with accessories  Cone Size [mm] 20.3 Length [mm] 40 Required quantity 2 Thread Size M16x1,5 replacement in pairs recommended			
<b>References</b> Volkswagen 701 407 361 B			
<b>Application info</b> Volkswagen Transporter IV (07/90-06/03)			
Ball joint		116 010 7193/HD	MBJ0095HD
<b>Notes</b>  Carbon Neutral Front Axle Left Front Axle Right Lower with accessories  Length [mm] 40 Required quantity 2 Thread Size M16x1,5 reinforced version replacement in pairs recommended			
<b>References</b> Volkswagen 701 407 361 B			
<b>Application info</b> Volkswagen Transporter IV (07/90-06/03)			

**Ball joint** **116 010 8223** **MBJ0096**

**Notes**

Front Axle Left  
 Front Axle Right  
 Lower  
 with accessories

Required quantity 2  
 replacement in pairs recommended



**References**

Skoda 6U0 407 365 Volkswagen 6U0 407 365

**Application info**

Skoda Favorit (06/88-06/97) Skoda Felicia (10/94-04/02)  
 Volkswagen Caddy II (9K9, 9K9B, 9U7) (11/95-06/09)

**Ball joint** **116 010 8248** **MBJ0097**

**Notes**

with accessories  
 Paired article number 116 010 8249 | MBJ0098  
 Required quantity 1  
 Thread Size M10x10

replacement in pairs recommended



**References**

Seat 6N0 407 365 A Volkswagen 6N0 407 365 A

**Application info**

Seat Arosa (6H) (05/97-06/04) Volkswagen Lupo (09/98-07/05)  
 Volkswagen Polo (6N\_) (09/94-10/01)

**Ball joint**

116 010 8249

MBJ0098

**Notes**

with accessories  
 Paired article number 116 010 8248 | MBJ0097  
 Required quantity 1  
 Thread Size M10x1,0  
 replacement in pairs recommended



**References**

Seat 6N0 407 365 Volkswagen 6N0 407 365

**Application info**

Seat Arosa (6H) (05/97-06/04) Volkswagen Lupo (09/98-07/05)  
 Volkswagen Polo (6N\_) (09/94-10/01)

**Ball joint**

116 010 8287/HD

MBJ0099HD

**Notes**

Carbon Neutral  
 Front Axle Left  
 Lower  
 with accessories  
 Paired article number 116 010 8288/HD | MBJ0100HD  
 Required quantity 1  
 Thread Size M12x1,5  
 reinforced version  
 replacement in pairs recommended



**References**

Audi 1J0 407 365 A	Audi 1J0 407 365 C
Audi 1J0 407 365 D	Audi 1J0 407 365 J
Seat 1J0 407 365 C	Seat 1J0 407 365 H
Seat 1J0 407 365 J	Skoda 1J0 407 365 C
Skoda 1J0 407 365 D	Skoda 1J0 407 365 H
Skoda 1J0 407 365 J	Volkswagen 1J0 407 365 A
Volkswagen 1J0 407 365 C	Volkswagen 1J0 407 365 D
Volkswagen 1J0 407 365 H	Volkswagen 1J0 407 365 J
Volkswagen (FAW) 1J0 407 365 C	Volkswagen (SVW) 1JD 407 365

**Application info**

Audi A3 I (8L\_) (09/96-09/06)

Skoda Octavia I (1U\_) (09/96-12/10)

Volkswagen Bora V (Mex) (01/07--)

Volkswagen Golf VI (5K1, 517, AJ5) (10/08-05/16)

Volkswagen New Beetle (1Y7, 9C1, 1C1) (01/98-12/11)

Seat Leon I / Toledo II (1M\_) (10/98-06/06)

Volkswagen Bora (1J2, 1J6) (10/98-12/13)

Volkswagen Golf IV (1J1, 1J5) (08/97-06/14)

Volkswagen Jetta City (09/06-12/09)

**Ball joint****116 010 8288/HD****MBJ0100HD****Notes**

Carbon Neutral

Front Axle Right

Lower

with accessories

116 010 8287/HD | MBJ0099HD

1

M12x1,5

Paired article number

Required quantity

Thread Size

reinforced version

replacement in pairs recommended

**References**

Audi 1J0 407 366 A

Audi 1J0 407 366 D

Seat 1J0 407 366 C

Seat 1J0 407 366 J

Skoda 1J0 407 366 D

Skoda 1J0 407 366 J

Volkswagen 1J0 407 366 A

Volkswagen 1J0 407 366 D

Volkswagen 1J0 407 366 J

Volkswagen (SVW) 1JD 407 366

Audi 1J0 407 366 C

Audi 1J0 407 366 J

Seat 1J0 407 366 H

Skoda 1J0 407 366 C

Skoda 1J0 407 366 H

Skoda 1J0 422 366 C

Volkswagen 1J0 407 366 C

Volkswagen 1J0 407 366 H

Volkswagen (FAW) 1J0 407 366 C

**Application info**

Audi A3 I (8L\_) (09/96-09/06)

Skoda Octavia I (1U\_) (09/96-12/10)

Volkswagen Bora V (Mex) (01/07--)

Volkswagen Golf VI (5K1, 517, AJ5) (10/08-05/16)

Volkswagen New Beetle (1Y7, 9C1, 1C1) (01/98-12/11)

Seat Leon I / Toledo II (1M\_) (10/98-06/06)

Volkswagen Bora (1J2, 1J6) (10/98-12/13)

Volkswagen Golf IV (1J1, 1J5) (08/97-06/14)

Volkswagen Jetta City (09/06-12/09)

**Ball joint**

116 010 9001

MBJ0101

**Notes**

Front Axle Left  
 Front Axle Right  
 Upper

Height [mm] 45  
 Outer Diameter [mm] 38.3  
 Required quantity 2  
 Thread Size M12x1,5  
 replacement in pairs recommended

**References**

Volkswagen 131 405 361 F

**Application info**

Volkswagen Käfer / Karmann Ghia (12/47-08/03)

**Ball joint**

116 010 9002

MBJ0102

**Notes**

Front Axle Left  
 Front Axle Right  
 Lower



Height [mm] 54  
 Outer Diameter [mm] 38.3  
 Required quantity 2  
 Thread Size M12x1,5  
 replacement in pairs recommended



**References**



Volkswagen 131 405 371 G

**Application info**

Volkswagen Käfer / Karmann Ghia (12/47-08/03)

Control arm		016 035 0008	MCA0001								
<p><b>Notes</b></p> <p>Aluminium Control Arm Front Front Axle Left Lower with rubber mount</p> <p>Paired article number Required quantity replacement in pairs recommended</p>											
<p><b>References</b></p> <table border="0"> <tr> <td>Mercedes-Benz 220 330 18 11</td> <td>Mercedes-Benz 220 330 33 11</td> </tr> <tr> <td>Mercedes-Benz 220 330 43 11</td> <td>Mercedes-Benz 220 330 57 11</td> </tr> <tr> <td>Mercedes-Benz A 220 330 18 11</td> <td>Mercedes-Benz A 220 330 33 11</td> </tr> <tr> <td>Mercedes-Benz A 220 330 43 11</td> <td>Mercedes-Benz A 220 330 57 11</td> </tr> </table>				Mercedes-Benz 220 330 18 11	Mercedes-Benz 220 330 33 11	Mercedes-Benz 220 330 43 11	Mercedes-Benz 220 330 57 11	Mercedes-Benz A 220 330 18 11	Mercedes-Benz A 220 330 33 11	Mercedes-Benz A 220 330 43 11	Mercedes-Benz A 220 330 57 11
Mercedes-Benz 220 330 18 11	Mercedes-Benz 220 330 33 11										
Mercedes-Benz 220 330 43 11	Mercedes-Benz 220 330 57 11										
Mercedes-Benz A 220 330 18 11	Mercedes-Benz A 220 330 33 11										
Mercedes-Benz A 220 330 43 11	Mercedes-Benz A 220 330 57 11										
<p><b>Application info</b></p> <table border="0"> <tr> <td>Mercedes-Benz BM 215 (S-Class) (03/99-12/06)</td> <td>Mercedes-Benz BM 220 (S-Class) (09/98-08/05)</td> </tr> </table>				Mercedes-Benz BM 215 (S-Class) (03/99-12/06)	Mercedes-Benz BM 220 (S-Class) (09/98-08/05)						
Mercedes-Benz BM 215 (S-Class) (03/99-12/06)	Mercedes-Benz BM 220 (S-Class) (09/98-08/05)										
Control arm		016 035 0009	MCA0002								
<p><b>Notes</b></p> <p>Aluminium Control Arm Front Front Axle Right Lower with rubber mount</p> <p>Paired article number Required quantity replacement in pairs recommended</p>											
<p><b>References</b></p> <table border="0"> <tr> <td>Mercedes-Benz 220 330 17 11</td> <td>Mercedes-Benz 220 330 34 11</td> </tr> <tr> <td>Mercedes-Benz 220 330 44 11</td> <td>Mercedes-Benz 220 330 58 11</td> </tr> <tr> <td>Mercedes-Benz A 220 330 17 11</td> <td>Mercedes-Benz A 220 330 34 11</td> </tr> <tr> <td>Mercedes-Benz A 220 330 44 11</td> <td>Mercedes-Benz A 220 330 58 11</td> </tr> </table>				Mercedes-Benz 220 330 17 11	Mercedes-Benz 220 330 34 11	Mercedes-Benz 220 330 44 11	Mercedes-Benz 220 330 58 11	Mercedes-Benz A 220 330 17 11	Mercedes-Benz A 220 330 34 11	Mercedes-Benz A 220 330 44 11	Mercedes-Benz A 220 330 58 11
Mercedes-Benz 220 330 17 11	Mercedes-Benz 220 330 34 11										
Mercedes-Benz 220 330 44 11	Mercedes-Benz 220 330 58 11										
Mercedes-Benz A 220 330 17 11	Mercedes-Benz A 220 330 34 11										
Mercedes-Benz A 220 330 44 11	Mercedes-Benz A 220 330 58 11										
<p><b>Application info</b></p> <table border="0"> <tr> <td>Mercedes-Benz BM 215 (S-Class) (03/99-12/06)</td> <td>Mercedes-Benz BM 220 (S-Class) (09/98-08/05)</td> </tr> </table>				Mercedes-Benz BM 215 (S-Class) (03/99-12/06)	Mercedes-Benz BM 220 (S-Class) (09/98-08/05)						
Mercedes-Benz BM 215 (S-Class) (03/99-12/06)	Mercedes-Benz BM 220 (S-Class) (09/98-08/05)										

Control arm		016 035 0025	MSR0124
<p><b>Notes</b></p> <p>Rear Axle Left Rear Axle Right Semi-Trailing Arm Sheet Steel Upper outer</p> <p>Required quantity replacement in pairs recommended</p>			
<p><b>References</b></p> <p>Infiniti 55120 5DA0A Mercedes-Benz A 246 350 10 06</p>		<p>Mercedes-Benz 246 350 10 06</p>	
<p><b>Application info</b></p> <p>Infiniti Q30 (11/15--) Mercedes-Benz BM 117 (CLA) (01/13-03/19) Mercedes-Benz BM 176 (A-Class) (06/12-05/18)</p>		<p>Infiniti QX30 (04/16--) Mercedes-Benz BM 156 (GLA-Class) (12/13--) Mercedes-Benz BM 246 (B-Class) (10/11-12/18)</p>	
Control arm		016 050 0000	MCA0003
<p><b>Notes</b></p> <p>Aluminium Control Arm Front Axle Left Upper with ball joint with rubber mount</p> <p>Paired article number Required quantity Thread Size replacement in pairs recommended</p>			
<p><b>References</b></p> <p>Mercedes-Benz 251 330 07 07 Mercedes-Benz A 251 330 07 07</p>		<p>Mercedes-Benz 251 330 25 00 Mercedes-Benz A 251 330 25 00</p>	
<p><b>Application info</b></p> <p>Mercedes-Benz BM 164 (GL-Class) (09/06-12/12) Mercedes-Benz BM 251 (R-Class) (08/05-10/17)</p>		<p>Mercedes-Benz BM 164 (M-Class) (02/05-12/12)</p>	

Control arm		016 050 0000/S	MCA1092
<b>Notes</b>  Aluminium Control Arm Front Axle Left Upper with ball joint with fastening material with rubber mount  Paired article number Required quantity Thread Size replacement in pairs recommended			
<b>References</b> Mercedes-Benz 251 330 07 07 Mercedes-Benz A 251 330 07 07		Mercedes-Benz 251 330 25 00 Mercedes-Benz A 251 330 25 00	
<b>Application info</b> Mercedes-Benz BM 164 (GL-Class) (09/06-12/12) Mercedes-Benz BM 251 (R-Class) (08/05-10/17)		Mercedes-Benz BM 164 (M-Class) (02/05-12/12)	
Control arm		016 050 0001	MCA0004
<b>Notes</b>  Aluminium Control Arm Front Axle Right Upper with ball joint with rubber mount  Paired article number Required quantity Thread Size replacement in pairs recommended			
<b>References</b> Mercedes-Benz 251 330 08 07 Mercedes-Benz A 251 330 08 07		Mercedes-Benz 251 330 26 00 Mercedes-Benz A 251 330 26 00	
<b>Application info</b> Mercedes-Benz BM 164 (GL-Class) (09/06-12/12) Mercedes-Benz BM 251 (R-Class) (08/05-10/17)		Mercedes-Benz BM 164 (M-Class) (02/05-12/12)	



**Control arm**

016 050 0001/S

MCA1093

**Notes**

Aluminium  
Control Arm  
Front Axle Right  
Upper  
with ball joint  
with fastening material  
with rubber mount



Paired article number 016 050 0000/S | MCA1092  
Required quantity 1  
Thread Size M14x1,5  
replacement in pairs recommended

**References**

Mercedes-Benz 251 330 08 07 Mercedes-Benz 251 330 26 00  
Mercedes-Benz A 251 330 08 07 Mercedes-Benz A 251 330 26 00

**Application info**

Mercedes-Benz BM 164 (GL-Class) (09/06-12/12) Mercedes-Benz BM 164 (M-Class) (02/05-12/12)  
Mercedes-Benz BM 251 (R-Class) (08/05-10/17)

**Control arm**

016 050 0006

MCA0007

**Notes**

Control Arm  
Front Axle Left  
Front Axle Right  
Lower  
Sheet Steel  
with rubber mount  
without ball joint



Required quantity 2  
replacement in pairs recommended

**References**

Smart 0007001V004000000 Smart 0007001V006  
Smart 0007001V006000000 Smart 0007001V007  
Smart 0007001V007000000 Smart 0014141V001  
Smart 0014141V001000000 Smart 0014141V002  
Smart 0014141V002000000 Smart 07001V006000  
Smart 07001V007000 Smart 14141V001000  
Smart 14141V002000000 Smart 7001V006000000

**Application info**

Smart City Coupé / Cabrio (07/98-01/04)  
 Smart Fortwo I (01/04-02/07)

Smart Crossblade (06/02-12/03)  
 Smart Roadster (04/03-11/05)

**Control arm**

016 050 0007

MCA0008

**Notes**

Cast Steel  
 Control Arm  
 Front Axle Left  
 Lower  
 Rear  
 with rubber mount  
 without ball joint

Length [mm] 409  
 Paired article number 016 050 0008 | MCA0009  
 Required quantity 1  
 replacement in pairs recommended



**References**

Mercedes-Benz 212 330 29 11  
 Mercedes-Benz A 212 330 29 11  
 Mercedes-Benz (BBDC) 212 330 29 11  
 Mercedes-Benz (BBDC) A 212 330 29 11

Mercedes-Benz 212 330 39 00  
 Mercedes-Benz A 212 330 39 00  
 Mercedes-Benz (BBDC) 212 330 39 00  
 Mercedes-Benz (BBDC) A 212 330 39 00

**Application info**

Mercedes-Benz BM 212 (E-Class) (01/09-12/16)

**Control arm**

016 050 0008

MCA0009

**Notes**

Cast Steel  
 Control Arm  
 Front Axle Right  
 Lower  
 Rear  
 with rubber mount  
 without ball joint

Length [mm] 409  
 Paired article number 016 050 0007 | MCA0008  
 Required quantity 1  
 replacement in pairs recommended



**References**

Mercedes-Benz 212 330 30 11

Mercedes-Benz A 212 330 30 11

Mercedes-Benz (BBDC) 212 330 30 11

Mercedes-Benz (BBDC) A 212 330 30 11

Mercedes-Benz 212 330 40 00

Mercedes-Benz A 212 330 40 00

Mercedes-Benz (BBDC) 212 330 40 00

Mercedes-Benz (BBDC) A 212 330 40 00

**Application info**

Mercedes-Benz BM 212 (E-Class) (01/09-12/16)

**Control arm**

016 050 0017

MCA0014

**Notes**

Control Arm  
Front Axle Left  
Lower  
Rear  
Steel  
with ball joint  
with rubber mount

Paired article number

016 050 0018 | MCA0015

Required quantity

1

replacement in pairs recommended

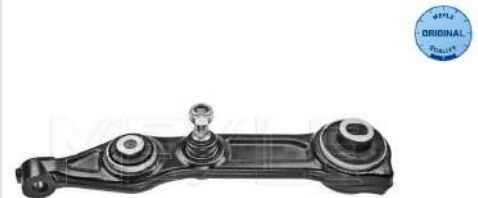

**References**

Mercedes-Benz 211 330 81 07

Mercedes-Benz A 211 330 81 07

Mercedes-Benz (BBDC) 211 330 91 07

Mercedes-Benz 211 330 91 07

Mercedes-Benz A 211 330 91 07

Mercedes-Benz (BBDC) A 211 330 91 07

**Application info**

Mercedes-Benz BM 211 (E-Class) (03/02-07/09)

Mercedes-Benz BM 219 (CLS) (10/04-02/11)

**Control arm**

016 050 0018

MCA0015

**Notes**

Control Arm  
Front Axle Right  
Lower  
Rear  
Steel  
with ball joint  
with rubber mount

Paired article number

016 050 0017 | MCA0014

Required quantity

1

replacement in pairs recommended



**References**

Mercedes-Benz 211 330 82 07

Mercedes-Benz A 211 330 82 07

Mercedes-Benz (BBDC) 211 330 92 07

Mercedes-Benz 211 330 92 07

Mercedes-Benz A 211 330 92 07

Mercedes-Benz (BBDC) A 211 330 92 07

**Application info**

Mercedes-Benz BM 211 (E-Class) (03/02-07/09)

Mercedes-Benz BM 219 (CLS) (10/04-02/11)

**Control arm**

016 050 0021

MCA0018

**Notes**

Control Arm  
 Front Axle Left  
 Lower  
 Sheet Steel  
 with ball joint  
 with right-hand thread  
 with rubber mount  
 Paired article number 016 050 0022 | MCA0019  
 Required quantity 1  
 Thread Size M12x1,5

Paired article number

Required quantity

Thread Size

replacement in pairs recommended



**References**

Mercedes-Benz 168 330 08 07

Mercedes-Benz 168 330 11 07

Mercedes-Benz 168 330 23 07

Mercedes-Benz A 168 330 08 27

Mercedes-Benz A 168 330 17 07

Mercedes-Benz 168 330 08 27

Mercedes-Benz 168 330 17 07

Mercedes-Benz A 168 330 08 07

Mercedes-Benz A 168 330 11 07

Mercedes-Benz A 168 330 23 07

**Application info**

Mercedes-Benz BM 168 (A-Class) (07/97-08/05)

Control arm		016 050 0022	MCA0019
<b>Notes</b>	Control Arm Front Axle Right Lower Sheet Steel with ball joint with right-hand thread with rubber mount		
Paired article number	016 050 0021   MCA0018		
Required quantity	1		
Thread Size replacement in pairs recommended	M12x1,5		

References	
Mercedes-Benz 168 330 09 07	Mercedes-Benz 168 330 09 27
Mercedes-Benz 168 330 12 07	Mercedes-Benz 168 330 18 07
Mercedes-Benz 168 330 24 07	Mercedes-Benz A 168 330 09 07
Mercedes-Benz A 168 330 09 27	Mercedes-Benz A 168 330 12 07
Mercedes-Benz A 168 330 18 07	Mercedes-Benz A 168 330 24 07

Application info
Mercedes-Benz BM 168 (A-Class) (07/97-08/05)

Control arm		016 050 0023/HD	MCA0020HD
<b>Notes</b>	Aluminium Carbon Neutral Control Arm Front Axle Left Lower with ball joint with rubber mount		
Paired article number	016 050 0024/HD   MCA0021HD		
Replace in pairs only Required quantity	1		
reinforced version			

References	
Mercedes-Benz 221 330 01 41	Mercedes-Benz 221 330 23 11
Mercedes-Benz 221 330 63 11	Mercedes-Benz A 221 330 01 41
Mercedes-Benz A 221 330 23 11	Mercedes-Benz A 221 330 63 11

**Application info**

Mercedes-Benz BM 216 (S-Class) (05/06-12/13)  
 Mercedes-Benz BM 221 (S-Class) (09/05-12/13)

Mercedes-Benz BM 220 (S-Class) (09/98-08/05)

**Control arm**

016 050 0024/HD

MCA0021HD

**Notes**

Aluminium  
 Carbon Neutral  
 Control Arm  
 Front Axle Right  
 Lower  
 with ball joint  
 with rubber mount

Paired article number 016 050 0023/HD | MCA0020HD  
 Replace in pairs only  
 Required quantity 1  
 reinforced version

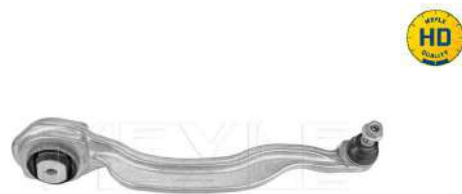

**References**

Mercedes-Benz 221 330 02 41  
 Mercedes-Benz 221 330 64 11  
 Mercedes-Benz A 221 330 24 11

Mercedes-Benz 221 330 24 11  
 Mercedes-Benz A 221 330 02 41  
 Mercedes-Benz A 221 330 64 11

**Application info**

Mercedes-Benz BM 216 (S-Class) (05/06-12/13)  
 Mercedes-Benz BM 221 (S-Class) (09/05-12/13)

Mercedes-Benz BM 220 (S-Class) (09/98-08/05)

**Control arm**

016 050 0025/HD

MCA0022HD

**Notes**

Aluminium  
 Carbon Neutral  
 Control Arm  
 Front Axle Left  
 Upper  
 with ball joint  
 with fastening material  
 with rubber mount

Cone Size [mm] 14  
 Paired article number 016 050 0026/HD | MCA0023HD  
 Replace in pairs only  
 Required quantity 1  
 reinforced version



**References**

Mercedes-Benz 221 330 03 07  
 Mercedes-Benz A 221 330 03 07

Mercedes-Benz 221 330 89 07  
 Mercedes-Benz A 221 330 89 07

**Application info**

Mercedes-Benz BM 216 (S-Class) (05/06-12/13)

Mercedes-Benz BM 221 (S-Class) (09/05-12/13)

**Control arm****016 050 0026/HD****MCA0023HD****Notes**

Aluminium  
 Carbon Neutral  
 Control Arm  
 Front Axle Right  
 Upper  
 with ball joint  
 with fastening material  
 with rubber mount

Cone Size [mm]

14

Paired article number

016 050 0025/HD | MCA0022HD

Replace in pairs only

Required quantity

1

reinforced version

**References**

Mercedes-Benz 221 330 04 07  
 Mercedes-Benz A 221 330 04 07

Mercedes-Benz 221 330 90 07  
 Mercedes-Benz A 221 330 90 07

**Application info**

Mercedes-Benz BM 216 (S-Class) (05/06-12/13)

Mercedes-Benz BM 221 (S-Class) (09/05-12/13)

**Control arm** 016 050 0027/HD MCA0024HD

**Notes**

Aluminium  
Carbon Neutral  
Control Arm  
Front  
Front Axle Left  
Lower  
with ball joint  
with rubber mount

Length [mm] 401  
Paired article number 016 050 0028/HD | MCA0025HD  
Replace in pairs only  
Required quantity 1  
Thread Size M14x1,5  
reinforced version



**References**

Mercedes-Benz 212 330 27 11 Mercedes-Benz A 212 330 27 11  
Mercedes-Benz (BBDC) 212 330 27 11 Mercedes-Benz (BBDC) A 212 330 27 11

**Application info**

Mercedes-Benz BM 212 (E-Class) (01/09-12/16)

**Control arm** 016 050 0028/HD MCA0025HD

**Notes**

Aluminium  
Carbon Neutral  
Control Arm  
Front  
Front Axle Right  
Lower  
with ball joint  
with rubber mount

Length [mm] 401  
Paired article number 016 050 0027/HD | MCA0024HD  
Replace in pairs only  
Required quantity 1  
Thread Size M14x1,5  
reinforced version

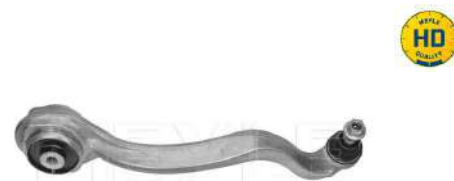



**References**

Mercedes-Benz 212 330 28 11

Mercedes-Benz (BBDC) 212 330 28 11

Mercedes-Benz A 212 330 28 11

Mercedes-Benz (BBDC) A 212 330 28 11

**Application info**

Mercedes-Benz BM 212 (E-Class) (01/09-12/16)

**Control arm**

016 050 0029

MCA0026

**Notes**

Control Arm

Front Axle Left

Lower

Rear

Steel

with rubber mount

Paired article number

016 050 0030 | MCA0027

Required quantity

1

replacement in pairs recommended



**References**

Mercedes-Benz 203 330 19 11

Mercedes-Benz 204 330 19 11

Mercedes-Benz A 203 330 33 11

Mercedes-Benz 203 330 33 11

Mercedes-Benz A 203 330 19 11

Mercedes-Benz A 204 330 19 11

**Application info**

Mercedes-Benz BM 171 (SLK) (03/04-12/11)

Mercedes-Benz BM 209 (CLK) (05/02-03/10)

Mercedes-Benz BM 203 (C-Class) (05/00-06/11)

**Control arm**

016 050 0030

MCA0027

**Notes**

Control Arm

Front Axle Right

Lower

Rear

Steel

with rubber mount

Paired article number

016 050 0029 | MCA0026

Required quantity

1

replacement in pairs recommended



**References**

Mercedes-Benz 203 330 20 11  
 Mercedes-Benz 204 330 20 11  
 Mercedes-Benz A 203 330 34 11

Mercedes-Benz 203 330 34 11  
 Mercedes-Benz A 203 330 20 11  
 Mercedes-Benz A 204 330 20 11

**Application info**

Mercedes-Benz BM 171 (SLK) (03/04-12/11)  
 Mercedes-Benz BM 209 (CLK) (05/02-03/10)

Mercedes-Benz BM 203 (C-Class) (05/00-06/11)

**Control arm**

016 050 0031/HD

MCA0028HD

**Notes**

Aluminium  
 Carbon Neutral  
 Control Arm  
 Front  
 Front Axle Left  
 Lower  
 with rubber mount

Paired article number  
 Replace in pairs only  
 Required quantity  
 reinforced version

016 050 0032/HD | MCA0029HD

1

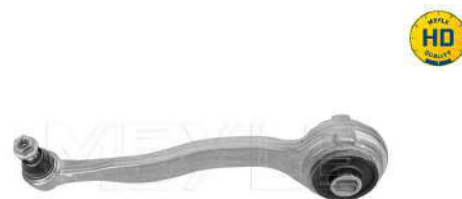

**References**

Mercedes-Benz 203 330 01 11  
 Mercedes-Benz 203 330 35 11  
 Mercedes-Benz 204 330 33 11  
 Mercedes-Benz 204 330 57 11  
 Mercedes-Benz A 203 330 01 11  
 Mercedes-Benz A 203 330 35 11  
 Mercedes-Benz A 204 330 33 11  
 Mercedes-Benz A 204 330 57 11  
 Mercedes-Benz (BBDC) 204 330 43 11  
 Mercedes-Benz (BBDC) A 204 330 43 11

Mercedes-Benz 203 330 16 11  
 Mercedes-Benz 203 330 39 11  
 Mercedes-Benz 204 330 43 11  
 Mercedes-Benz 204 330 87 11  
 Mercedes-Benz A 203 330 16 11  
 Mercedes-Benz A 203 330 39 11  
 Mercedes-Benz A 204 330 43 11  
 Mercedes-Benz A 204 330 87 11  
 Mercedes-Benz (BBDC) 204 330 87 11  
 Mercedes-Benz (BBDC) A 204 330 87 11

**Application info**

Mercedes-Benz BM 171 (SLK) (03/04-12/11)  
 Mercedes-Benz BM 172 (SLK) (01/11--)  
 Mercedes-Benz BM 204 (C-Class) (01/07--)  
 Mercedes-Benz BM 209 (CLK) (05/02-03/10)

Mercedes-Benz BM 172 (SLC) (01/16--)  
 Mercedes-Benz BM 203 (C-Class) (05/00-06/11)  
 Mercedes-Benz BM 207 (E-Class) (01/09-12/16)

## Control arm

016 050 0032/HD

MCA0029HD

## Notes

Aluminium  
Carbon Neutral  
Control Arm  
Front  
Front Axle Right  
Lower  
with rubber mount

Paired article number 016 050 0031/HD | MCA0028HD  
Replace in pairs only  
Required quantity 1  
reinforced version

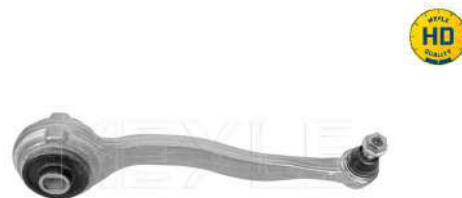

## References

Mercedes-Benz 203 330 02 11	Mercedes-Benz 203 330 17 11
Mercedes-Benz 203 330 36 11	Mercedes-Benz 203 330 40 11
Mercedes-Benz 204 330 34 11	Mercedes-Benz 204 330 44 11
Mercedes-Benz 204 330 58 11	Mercedes-Benz 204 330 88 11
Mercedes-Benz A 203 330 02 11	Mercedes-Benz A 203 330 17 11
Mercedes-Benz A 203 330 36 11	Mercedes-Benz A 203 330 40 11
Mercedes-Benz A 204 330 34 11	Mercedes-Benz A 204 330 44 11
Mercedes-Benz A 204 330 58 11	Mercedes-Benz A 204 330 88 11
Mercedes-Benz (BBDC) 204 330 44 11	Mercedes-Benz (BBDC) 204 330 88 11
Mercedes-Benz (BBDC) A 204 330 44 11	Mercedes-Benz (BBDC) A 204 330 88 11

## Application info

Mercedes-Benz BM 171 (SLK) (03/04-12/11)	Mercedes-Benz BM 172 (SLC) (01/16--)
Mercedes-Benz BM 172 (SLK) (01/11--)	Mercedes-Benz BM 203 (C-Class) (05/00-06/11)
Mercedes-Benz BM 204 (C-Class) (01/07--)	Mercedes-Benz BM 207 (E-Class) (01/09-12/16)
Mercedes-Benz BM 209 (CLK) (05/02-03/10)	

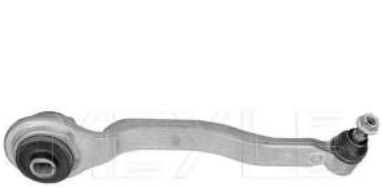
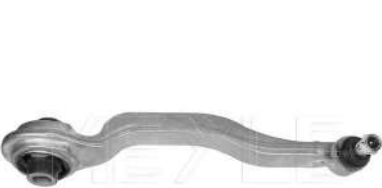
Control arm		016 050 0033/HD	MCA0030HD												
<p><b>Notes</b></p> <p>Aluminium Carbon Neutral Control Arm Front Front Axle Right Lower with rubber mount</p> <p>Paired article number 016 050 0034/HD   MCA0031HD</p> <p>Replace in pairs only</p> <p>Required quantity 1</p> <p>reinforced version</p>		 <p>A photograph of a silver-colored reinforced control arm with a yellow 'MEYLE HD REINFORCED' badge in the top right corner.</p>													
<p><b>References</b></p> <table border="0"> <tr> <td>Mercedes-Benz 211 330 12 11</td> <td>Mercedes-Benz 211 330 16 11</td> </tr> <tr> <td>Mercedes-Benz 211 330 30 11</td> <td>Mercedes-Benz 211 330 44 11</td> </tr> <tr> <td>Mercedes-Benz 211 330 50 11</td> <td>Mercedes-Benz A 211 330 12 11</td> </tr> <tr> <td>Mercedes-Benz A 211 330 16 11</td> <td>Mercedes-Benz A 211 330 30 11</td> </tr> <tr> <td>Mercedes-Benz A 211 330 44 11</td> <td>Mercedes-Benz A 211 330 50 11</td> </tr> <tr> <td>Mercedes-Benz (BBDC) 211 330 50 11</td> <td>Mercedes-Benz (BBDC) A 211 330 50 11</td> </tr> </table>				Mercedes-Benz 211 330 12 11	Mercedes-Benz 211 330 16 11	Mercedes-Benz 211 330 30 11	Mercedes-Benz 211 330 44 11	Mercedes-Benz 211 330 50 11	Mercedes-Benz A 211 330 12 11	Mercedes-Benz A 211 330 16 11	Mercedes-Benz A 211 330 30 11	Mercedes-Benz A 211 330 44 11	Mercedes-Benz A 211 330 50 11	Mercedes-Benz (BBDC) 211 330 50 11	Mercedes-Benz (BBDC) A 211 330 50 11
Mercedes-Benz 211 330 12 11	Mercedes-Benz 211 330 16 11														
Mercedes-Benz 211 330 30 11	Mercedes-Benz 211 330 44 11														
Mercedes-Benz 211 330 50 11	Mercedes-Benz A 211 330 12 11														
Mercedes-Benz A 211 330 16 11	Mercedes-Benz A 211 330 30 11														
Mercedes-Benz A 211 330 44 11	Mercedes-Benz A 211 330 50 11														
Mercedes-Benz (BBDC) 211 330 50 11	Mercedes-Benz (BBDC) A 211 330 50 11														
<p><b>Application info</b></p> <table border="0"> <tr> <td>Mercedes-Benz BM 211 (E-Class) (03/02-07/09)</td> <td>Mercedes-Benz BM 219 (CLS) (10/04-02/11)</td> </tr> <tr> <td>Mercedes-Benz BM 230 (SL) (10/01-01/12)</td> <td></td> </tr> </table>				Mercedes-Benz BM 211 (E-Class) (03/02-07/09)	Mercedes-Benz BM 219 (CLS) (10/04-02/11)	Mercedes-Benz BM 230 (SL) (10/01-01/12)									
Mercedes-Benz BM 211 (E-Class) (03/02-07/09)	Mercedes-Benz BM 219 (CLS) (10/04-02/11)														
Mercedes-Benz BM 230 (SL) (10/01-01/12)															
Control arm		016 050 0033	MCA0030												
<p><b>Notes</b></p> <p>Aluminium Control Arm Front Front Axle Right Lower with rubber mount</p> <p>Paired article number 016 050 0034   MCA0031</p> <p>Required quantity 1</p> <p>replacement in pairs recommended</p>		 <p>A photograph of a silver-colored control arm with a blue 'MEYLE ORIGINAL' badge in the top right corner.</p>													

**References**

- |                                    |                                      |
|------------------------------------|--------------------------------------|
| Mercedes-Benz 211 330 12 11        | Mercedes-Benz 211 330 16 11          |
| Mercedes-Benz 211 330 30 11        | Mercedes-Benz 211 330 44 11          |
| Mercedes-Benz 211 330 50 11        | Mercedes-Benz A 211 330 12 11        |
| Mercedes-Benz A 211 330 16 11      | Mercedes-Benz A 211 330 30 11        |
| Mercedes-Benz A 211 330 44 11      | Mercedes-Benz A 211 330 50 11        |
| Mercedes-Benz (BBDC) 211 330 50 11 | Mercedes-Benz (BBDC) A 211 330 50 11 |

**Application info**

- |  |  |
|--|--|
| Mercedes-Benz BM 211 (E-Class) (03/02-07/09) | Mercedes-Benz BM 219 (CLS) (10/04-02/11) |
| Mercedes-Benz BM 230 (SL) (10/01-01/12)      | Mercedes-Benz BM 231 (SL) (01/12--)      |

**Control arm**

**016 050 0034 MCA0031**

**Notes**

Aluminium  
Control Arm  
Front  
Front Axle Left  
Lower  
with rubber mount  
Paired article number 016 050 0033 | MCA0030  
Required quantity 1  
replacement in pairs recommended

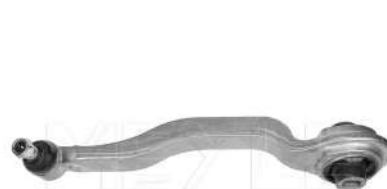



**References**

- |                                    |                                      |
|------------------------------------|--------------------------------------|
| Mercedes-Benz 211 330 11 11        | Mercedes-Benz 211 330 15 11          |
| Mercedes-Benz 211 330 29 11        | Mercedes-Benz 211 330 43 11          |
| Mercedes-Benz 211 330 49 11        | Mercedes-Benz A 211 330 11 11        |
| Mercedes-Benz A 211 330 15 11      | Mercedes-Benz A 211 330 29 11        |
| Mercedes-Benz A 211 330 43 11      | Mercedes-Benz A 211 330 49 11        |
| Mercedes-Benz (BBDC) 211 330 49 11 | Mercedes-Benz (BBDC) A 211 330 49 11 |

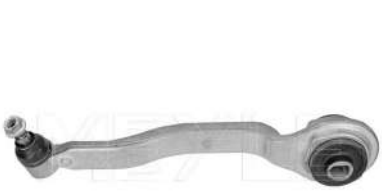

**Application info**

- |  |  |
|--|--|
| Mercedes-Benz BM 211 (E-Class) (03/02-07/09) | Mercedes-Benz BM 219 (CLS) (10/04-02/11) |
| Mercedes-Benz BM 230 (SL) (10/01-01/12)      | Mercedes-Benz BM 231 (SL) (01/12--)      |

Control arm		016 050 0034/HD	MCA0031HD
<b>Notes</b>	<p>Aluminium Carbon Neutral Control Arm Front Front Axle Left Lower with rubber mount</p>		
<p>Paired article number Replace in pairs only Required quantity reinforced version</p>	<p>016 050 0033/HD   MCA0030HD  1</p>		

References	
Mercedes-Benz 211 330 11 11	Mercedes-Benz 211 330 15 11
Mercedes-Benz 211 330 29 11	Mercedes-Benz 211 330 43 11
Mercedes-Benz 211 330 49 11	Mercedes-Benz A 211 330 11 11
Mercedes-Benz A 211 330 15 11	Mercedes-Benz A 211 330 29 11
Mercedes-Benz A 211 330 43 11	Mercedes-Benz A 211 330 49 11
Mercedes-Benz (BBDC) 211 330 49 11	Mercedes-Benz (BBDC) A 211 330 49 11

Application info	
Mercedes-Benz BM 211 (E-Class) (03/02-07/09)	Mercedes-Benz BM 219 (CLS) (10/04-02/11)
Mercedes-Benz BM 230 (SL) (10/01-01/12)	

Control arm		016 050 0041	MCA0034
<b>Notes</b>	<p>Control Arm Front Axle Left Lower Sheet Steel with ball joint with rubber mount</p>		
<p>Paired article number Required quantity replacement in pairs recommended</p>	<p>016 050 0042   MCA0035  1</p>		

References	
Mercedes-Benz 169 330 05 07	Mercedes-Benz 169 330 07 07
Mercedes-Benz 169 330 09 07	Mercedes-Benz A 169 330 05 07
Mercedes-Benz A 169 330 07 07	Mercedes-Benz A 169 330 09 07

**Application info**

Mercedes-Benz BM 169 (A-Class) (09/04-06/12)

Mercedes-Benz BM 245 (B-Class) (03/05-11/11)

**Control arm**

**016 050 0042**

**MCA0035**

**Notes**

Control Arm  
Front Axle Right  
Lower  
Sheet Steel  
with ball joint  
with rubber mount

Paired article number 016 050 0041 | MCA0034  
Required quantity 1  
replacement in pairs recommended



**References**

Mercedes-Benz 169 330 06 07  
Mercedes-Benz 169 330 10 07  
Mercedes-Benz A 169 330 08 07

Mercedes-Benz 169 330 08 07  
Mercedes-Benz A 169 330 06 07  
Mercedes-Benz A 169 330 10 07

**Application info**

Mercedes-Benz BM 169 (A-Class) (09/04-06/12)

Mercedes-Benz BM 245 (B-Class) (03/05-11/11)

**Control arm**

**016 050 0046**

**MCA0038**

**Notes**

Aluminium  
Control Arm  
Front Axle Left  
Upper  
with ball joint  
with rubber mount

Paired article number 016 050 0047 | MCA0039  
Required quantity 1  
replacement in pairs recommended



**References**



Mercedes-Benz 220 330 14 07  
Mercedes-Benz 220 330 93 07  
Mercedes-Benz A 220 330 83 07

Mercedes-Benz 220 330 83 07  
Mercedes-Benz A 220 330 14 07  
Mercedes-Benz A 220 330 93 07

**Application info**

Mercedes-Benz BM 215 (S-Class) (03/99-12/06)  
Mercedes-Benz BM 220 (S-Class) (09/98-08/05)

Mercedes-Benz BM 219 (CLS) (10/04-02/11)

Control arm		016 050 0047	MCA0039
<p><b>Notes</b></p> <p>Aluminium Control Arm Front Axle Right Upper with ball joint with rubber mount</p> <p>Paired article number Required quantity replacement in pairs recommended</p>			
<p><b>References</b></p> <p>Mercedes-Benz 220 330 15 07 Mercedes-Benz 220 330 94 07 Mercedes-Benz A 220 330 84 07</p>		<p>Mercedes-Benz 220 330 84 07 Mercedes-Benz A 220 330 15 07 Mercedes-Benz A 220 330 94 07</p>	
<p><b>Application info</b></p> <p>Mercedes-Benz BM 215 (S-Class) (03/99-12/06) Mercedes-Benz BM 220 (S-Class) (09/98-08/05)</p>		<p>Mercedes-Benz BM 219 (CLS) (10/04-02/11)</p>	
Control arm		016 050 0054/HD	MCA0040HD
<p><b>Notes</b></p> <p>Carbon Neutral Control Arm Front Axle Right Lower Sheet Steel with ball joint with rubber mount</p> <p>Paired article number Replace in pairs only Required quantity reinforced version</p>			
<p><b>References</b></p> <p>Mercedes-Benz 901 330 17 07 Mercedes-Benz 901 330 25 07 Mercedes-Benz A 901 330 19 07 Volkswagen 2D0 407 022 Volkswagen 2D0 407 022 B</p>		<p>Mercedes-Benz 901 330 19 07 Mercedes-Benz A 901 330 17 07 Mercedes-Benz A 901 330 25 07 Volkswagen 2D0 407 022 A Volkswagen 2D0 407 022 C</p>	



**Application info**

Mercedes-Benz BM 901 / 902 (Sprinter I) (01/95-05/06)  
 Mercedes-Benz BM 904 (Sprinter I) (02/95-05/12)  
 Volkswagen LT II (04/96-07/06)

Mercedes-Benz BM 903 (Sprinter I) (01/95-05/12)  
 Mercedes-Benz BM 909 (Sprinter) (09/13--)

**Control arm**

016 050 0056/HD

MCA0041HD

**Notes**

Carbon Neutral  
 Control Arm  
 Front Axle Left  
 Lower  
 Sheet Steel  
 with ball joint  
 with rubber mount



Paired article number 016 050 0054/HD | MCA0040HD  
 Replace in pairs only  
 Required quantity 1  
 reinforced version

**References**

Mercedes-Benz 901 330 16 07  
 Mercedes-Benz 901 330 24 07  
 Mercedes-Benz A 901 330 18 07  
 Volkswagen 2D0 407 021  
 Volkswagen 2D0 407 021 B

Mercedes-Benz 901 330 18 07  
 Mercedes-Benz A 901 330 16 07  
 Mercedes-Benz A 901 330 24 07  
 Volkswagen 2D0 407 021 A  
 Volkswagen 2D0 407 021 C

**Application info**

Mercedes-Benz BM 901 / 902 (Sprinter I) (01/95-05/06)  
 Mercedes-Benz BM 904 (Sprinter I) (02/95-05/12)  
 Volkswagen LT II (04/96-07/06)

Mercedes-Benz BM 903 (Sprinter I) (01/95-05/12)  
 Mercedes-Benz BM 909 (Sprinter) (09/13--)

Control arm		016 050 0060/HD	MCA0042HD
<p><b>Notes</b></p> <p>Carbon Neutral Control Arm Front Axle Left Lower Sheet Steel with ball joint with rubber mount</p> <p>Paired article number Replace in pairs only Required quantity reinforced version</p>	<p>016 050 0061/HD   MCA0043HD</p> <p>1</p>		





References			
Mercedes-Benz 639 330 04 10	Mercedes-Benz 639 330 08 10	Mercedes-Benz A 639 330 04 10	Mercedes-Benz A 639 330 08 10

Application info	
Mercedes-Benz BM 639 (Vito / Viano) (08/03--)	

Control arm		016 050 0061/HD	MCA0043HD
<p><b>Notes</b></p> <p>Carbon Neutral Control Arm Front Axle Right Lower Sheet Steel with ball joint with rubber mount</p> <p>Paired article number Replace in pairs only Required quantity reinforced version</p>	<p>016 050 0060/HD   MCA0042HD</p> <p>1</p>		

References			
Mercedes-Benz 639 330 05 10	Mercedes-Benz 639 330 09 10	Mercedes-Benz A 639 330 05 10	Mercedes-Benz A 639 330 09 10

Application info	
Mercedes-Benz BM 639 (Vito / Viano) (08/03--)	

Control arm		016 050 0066	MCA0048
<p><b>Notes</b></p> <p>Aluminium Control Arm Front Axle Left Lower Rear with ball joint with rubber mount</p> <p>Paired article number 016 050 0067   MCA0049 Required quantity 1 replacement in pairs recommended</p>		 	
<p><b>References</b></p> <p>Mercedes-Benz 204 330 31 11 Mercedes-Benz 204 330 67 11 Mercedes-Benz A 204 330 31 11 Mercedes-Benz A 204 330 67 11 Mercedes-Benz (BBDC) 204 330 67 11 Mercedes-Benz (BBDC) A 204 330 67 11</p>			
<p><b>Application info</b></p> <p>Mercedes-Benz BM 172 (SLC) (01/16--) Mercedes-Benz BM 204 (C-Class) (01/07--)</p> <p>Mercedes-Benz BM 172 (SLK) (01/11--) Mercedes-Benz BM 207 (E-Class) (01/09-12/16)</p>			
Control arm		016 050 0067	MCA0049
<p><b>Notes</b></p> <p>Aluminium Control Arm Front Axle Right Lower Rear with ball joint with rubber mount</p> <p>Paired article number 016 050 0066   MCA0048 Required quantity 1 replacement in pairs recommended</p>		 	
<p><b>References</b></p> <p>Mercedes-Benz 204 330 32 11 Mercedes-Benz 204 330 68 11 Mercedes-Benz A 204 330 32 11 Mercedes-Benz A 204 330 68 11 Mercedes-Benz (BBDC) 204 330 68 11 Mercedes-Benz (BBDC) A 204 330 68 11</p>			
<p><b>Application info</b></p> <p>Mercedes-Benz BM 172 (SLC) (01/16--) Mercedes-Benz BM 204 (C-Class) (01/07--)</p> <p>Mercedes-Benz BM 172 (SLK) (01/11--) Mercedes-Benz BM 207 (E-Class) (01/09-12/16)</p>			

Control arm		016 050 0068	MCA0050
<p><b>Notes</b></p> <p>Cast Steel Control Arm Front Axle Left Lower Rear for vehicles without electronic suspension control with ball joint with rubber mount</p> <p>Paired article number 016 050 0069   MCA0051 Required quantity 1 replacement in pairs recommended</p>			



References	
Mercedes-Benz 221 330 67 07	Mercedes-Benz 221 330 81 07
Mercedes-Benz A 221 330 67 07	Mercedes-Benz A 221 330 81 07

Application info
Mercedes-Benz BM 221 (S-Class) (09/05-12/13)

Control arm		016 050 0069	MCA0051
<p><b>Notes</b></p> <p>Cast Steel Control Arm Front Axle Right Lower Rear for vehicles without electronic suspension control with ball joint with rubber mount</p> <p>Paired article number 016 050 0068   MCA0050 Required quantity 1 replacement in pairs recommended</p>			

References	
Mercedes-Benz 221 330 68 07	Mercedes-Benz 221 330 82 07
Mercedes-Benz A 221 330 68 07	Mercedes-Benz A 221 330 82 07

Application info
Mercedes-Benz BM 221 (S-Class) (09/05-12/13)

Control arm		016 050 0071	MCA0053
<p><b>Notes</b></p> <p>Control Arm Front Axle Left Front Axle Right Sheet Steel with ball joint with rubber mount</p> <p>Required quantity 2 Thread Size M12x1,5 replacement in pairs recommended</p>			
<p><b>References</b></p> <p>Smart 451 330 00 10</p>		<p>Smart A 451 330 00 10</p>	
<p><b>Application info</b></p> <p>Smart Fortwo II (01/07--)</p>			
Control arm		016 050 0072	MCA0762
<p><b>Notes</b></p> <p>Aluminium Control Arm Front Axle Left with ball joint with rubber mount</p> <p>Paired article number 016 050 0073   MCA0763 Required quantity 1 Thread Size M14x1,5 replacement in pairs recommended</p>			
<p><b>References</b></p> <p>Mercedes-Benz 156 330 01 00 Mercedes-Benz 246 330 47 00 Mercedes-Benz A 246 330 17 07 Mercedes-Benz (BBDC) 156 330 01 00</p>		<p>Mercedes-Benz 246 330 17 07 Mercedes-Benz A 156 330 01 00 Mercedes-Benz A 246 330 47 00 Mercedes-Benz (BBDC) A 156 330 01 00</p>	
<p><b>Application info</b></p> <p>Mercedes-Benz BM 117 (CLA) (01/13-03/19) Mercedes-Benz BM 176 (A-Class) (06/12-05/18)</p> <p>Mercedes-Benz BM 156 (GLA-Class) (12/13--) Mercedes-Benz BM 246 (B-Class) (10/11-12/18)</p>			

**Control arm**

016 050 0073

MCA0763

**Notes**

Aluminium  
Control Arm  
Front Axle Right  
with ball joint  
with rubber mount

Paired article number 016 050 0072 | MCA0762  
Required quantity 1  
Thread Size M14x1,5  
replacement in pairs recommended



**References**

- |                                    |                                      |
|------------------------------------|--------------------------------------|
| Mercedes-Benz 156 330 02 00        | Mercedes-Benz 246 330 18 07          |
| Mercedes-Benz 246 330 48 00        | Mercedes-Benz A 156 330 02 00        |
| Mercedes-Benz A 246 330 18 07      | Mercedes-Benz A 246 330 48 00        |
| Mercedes-Benz (BBDC) 156 330 02 00 | Mercedes-Benz (BBDC) A 156 330 02 00 |

**Application info**

- |  |  |
|--|--|
| Mercedes-Benz BM 117 (CLA) (01/13-03/19)     | Mercedes-Benz BM 156 (GLA-Class) (12/13--)   |
| Mercedes-Benz BM 176 (A-Class) (06/12-05/18) | Mercedes-Benz BM 246 (B-Class) (10/11-12/18) |

**Control arm**

016 050 0077

MCA0981

**Notes**

Cast Steel  
Control Arm  
Front Axle Left  
Lower  
with rubber mount

Paired article number 016 050 0078 | MCA0982  
Required quantity 1  
replacement in pairs recommended



**References**

- |                               |                               |
|-------------------------------|-------------------------------|
| Mercedes-Benz 164 330 17 07   | Mercedes-Benz 164 330 25 07   |
| Mercedes-Benz 164 330 29 07   | Mercedes-Benz 164 330 34 07   |
| Mercedes-Benz A 164 330 17 07 | Mercedes-Benz A 164 330 25 07 |
| Mercedes-Benz A 164 330 29 07 | Mercedes-Benz A 164 330 34 07 |

**Application info**

- |   |  |
|---|--|
| Mercedes-Benz BM 164 (GL-Class) (09/06-12/12) | Mercedes-Benz BM 164 (M-Class) (02/05-12/12) |
|---|--|

**Control arm** **016 050 0078** **MCA0982**

**Notes**

Cast Steel  
Control Arm  
Front Axle Right  
Lower  
with rubber mount

Paired article number 016 050 0077 | MCA0981  
Required quantity 1  
replacement in pairs recommended



**References**

Mercedes-Benz 164 330 18 07	Mercedes-Benz 164 330 26 07
Mercedes-Benz 164 330 30 07	Mercedes-Benz 164 330 35 07
Mercedes-Benz A 164 330 18 07	Mercedes-Benz A 164 330 26 07
Mercedes-Benz A 164 330 30 07	Mercedes-Benz A 164 330 35 07

**Application info**

Mercedes-Benz BM 164 (GL-Class) (09/06-12/12)	Mercedes-Benz BM 164 (M-Class) (02/05-12/12)
---	--

**Control arm** **016 050 0079/HD** **MCA1144HD**

**Notes**

Aluminium  
Carbon Neutral  
Control Arm  
Front  
Front Axle Left  
Lower  
with ball joint  
with rubber mount

Paired article number 016 050 0080/HD | MCA1145HD  
Replace in pairs only  
Required quantity 1  
reinforced version

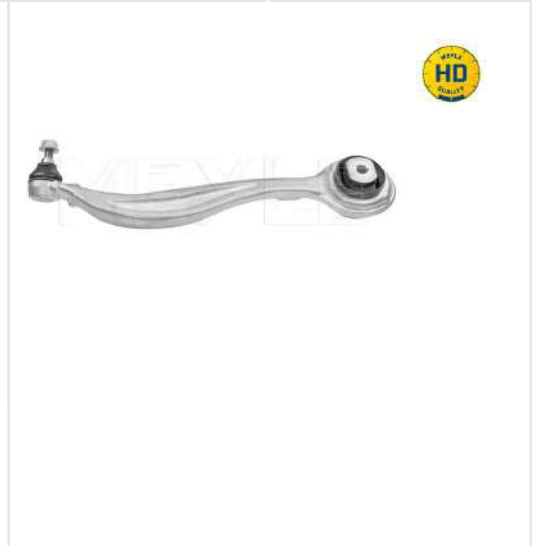

**References**

Mercedes-Benz 204 330 81 11	Mercedes-Benz 204 330 83 11
Mercedes-Benz A 204 330 81 11	Mercedes-Benz A 204 330 83 11
Mercedes-Benz (BBDC) 204 330 81 11	Mercedes-Benz (BBDC) 204 330 83 11
Mercedes-Benz (BBDC) A 204 330 81 11	Mercedes-Benz (BBDC) A 204 330 83 11

**Application info**

Mercedes-Benz BM 204 (GLK-Class) (06/08-12/15)

**Control arm**

016 050 0080/HD

MCA1145HD

**Notes**

Aluminium  
Carbon Neutral  
Control Arm  
Front  
Front Axle Right  
Lower  
with ball joint  
with rubber mount

Paired article number 016 050 0079/HD | MCA1144HD  
Replace in pairs only  
Required quantity 1  
reinforced version



**References**

Mercedes-Benz 204 330 82 11	Mercedes-Benz 204 330 84 11
Mercedes-Benz A 204 330 82 11	Mercedes-Benz A 204 330 84 11
Mercedes-Benz (BBDC) 204 330 82 11	Mercedes-Benz (BBDC) 204 330 84 11
Mercedes-Benz (BBDC) A 204 330 82 11	Mercedes-Benz (BBDC) A 204 330 84 11

**Application info**

Mercedes-Benz BM 204 (GLK-Class) (06/08-12/15)

**Control arm**

016 050 0081/S

MCA1026

**Notes**

Aluminium  
Control Arm  
Front Axle Left  
Front Axle Right  
Lower  
Rear  
with accessories  
with ball joint  
with rubber mount

Required quantity 2  
replacement in pairs recommended





**References**

Mercedes-Benz 204 330 80 11

Mercedes-Benz (BBDC) 204 330 80 11

Mercedes-Benz A 204 330 80 11

Mercedes-Benz (BBDC) A 204 330 80 11

**Application info**

Mercedes-Benz BM 204 (GLK-Class) (06/08-12/15)

**Control arm**

016 050 0086/HD

MCA1186HD

**Notes**

Carbon Neutral  
Control Arm  
Front Axle Right  
Lower  
Sheet Steel  
with ball joint  
with rubber mount

Paired article number

016 050 0087/HD | MCA1187HD

Replace in pairs only

Required quantity

1



**References**

Mercedes-Benz 639 330 13 07

Mercedes-Benz A 639 330 13 07

Mercedes-Benz 639 330 15 01

Mercedes-Benz A 639 330 15 01

**Application info**

Mercedes-Benz BM 639 (Vito / Viano) (08/03--)

**Control arm**

016 050 0087/HD

MCA1187HD

**Notes**

Carbon Neutral  
Control Arm  
Front Axle Left  
Sheet Steel  
with ball joint  
with rubber mount

Paired article number

016 050 0086/HD | MCA1186HD

Replace in pairs only

Required quantity

1



**References**

Mercedes-Benz 639 330 12 07

Mercedes-Benz A 639 330 12 07

Mercedes-Benz 639 330 14 01

Mercedes-Benz A 639 330 14 01

**Application info**

Mercedes-Benz BM 639 (Vito / Viano) (08/03--)

**Control arm**

016 050 0092

MCA1134

**Notes**

Control Arm  
Front Axle Right  
Grey Cast Iron  
Lower  
with rubber mount

Paired article number 016 050 0093 | MCA1135  
Required quantity 1  
replacement in pairs recommended



**References**

- |                               |                               |
|-------------------------------|-------------------------------|
| Mercedes-Benz 251 330 12 07   | Mercedes-Benz 251 330 14 07   |
| Mercedes-Benz 251 330 16 07   | Mercedes-Benz 251 330 20 07   |
| Mercedes-Benz A 251 330 12 07 | Mercedes-Benz A 251 330 14 07 |
| Mercedes-Benz A 251 330 16 07 | Mercedes-Benz A 251 330 20 07 |

**Application info**

Mercedes-Benz BM 251 (R-Class) (08/05-10/17)

**Control arm**

016 050 0093

MCA1135

**Notes**

Control Arm  
Front Axle Left  
Grey Cast Iron  
Lower  
with rubber mount

Paired article number 016 050 0092 | MCA1134  
Required quantity 1  
replacement in pairs recommended



**References**

- |                               |                               |
|-------------------------------|-------------------------------|
| Mercedes-Benz 251 330 11 07   | Mercedes-Benz 251 330 13 07   |
| Mercedes-Benz 251 330 15 07   | Mercedes-Benz 251 330 19 07   |
| Mercedes-Benz A 251 330 11 07 | Mercedes-Benz A 251 330 13 07 |
| Mercedes-Benz A 251 330 15 07 | Mercedes-Benz A 251 330 19 07 |

**Application info**

Mercedes-Benz BM 251 (R-Class) (08/05-10/17)

<b>Control arm</b>		<b>016 050 0097/S</b>	<b>MCA1142</b>
--------------------	--	-----------------------	----------------

**Notes**

Aluminium  
Control Arm  
Front Axle Left  
Upper  
with accessories  
with ball joint  
with rubber mount

Paired article number 016 050 0098/S | MCA1143

Required quantity

1

replacement in pairs recommended



**References**

Mercedes-Benz 166 330 17 07

Mercedes-Benz A 166 330 17 07

**Application info**

Mercedes-Benz BM 166 (GL) (07/12-12/15)

Mercedes-Benz BM 166 (GLE) (03/15-10/19)

Mercedes-Benz BM 166 (GLS) (11/15-04/19)

Mercedes-Benz BM 166 (M-Class) (06/11-12/15)

<b>Control arm</b>		<b>016 050 0098/S</b>	<b>MCA1143</b>
--------------------	--	-----------------------	----------------

**Notes**

Aluminium  
Control Arm  
Front Axle Right  
Upper  
with accessories  
with ball joint  
with rubber mount

Paired article number 016 050 0097/S | MCA1142

Required quantity

1

replacement in pairs recommended



**References**

Mercedes-Benz 166 330 18 07

Mercedes-Benz A 166 330 18 07

**Application info**

Mercedes-Benz BM 166 (GL) (07/12-12/15)

Mercedes-Benz BM 166 (GLE) (03/15-10/19)

Mercedes-Benz BM 166 (GLS) (11/15-04/19)

Mercedes-Benz BM 166 (M-Class) (06/11-12/15)

<b>Control arm</b>	<b>016 050 0101</b>	<b>MCA1059</b>
--------------------	---------------------	----------------

**Notes**

Aluminium  
Control Arm  
Front  
Front Axle Left  
Lower  
with rubber mount

Paired article number 016 050 0102 | MCA1060  
Required quantity 1  
replacement in pairs recommended



**References**

- |                                      |                                      |
|--------------------------------------|--------------------------------------|
| Mercedes-Benz 203 330 01 11          | Mercedes-Benz 203 330 16 11          |
| Mercedes-Benz 203 330 35 11          | Mercedes-Benz 203 330 39 11          |
| Mercedes-Benz 204 330 33 11          | Mercedes-Benz 204 330 43 11          |
| Mercedes-Benz 204 330 57 11          | Mercedes-Benz 204 330 87 11          |
| Mercedes-Benz A 203 330 01 11        | Mercedes-Benz A 203 330 16 11        |
| Mercedes-Benz A 203 330 35 11        | Mercedes-Benz A 203 330 39 11        |
| Mercedes-Benz A 204 330 33 11        | Mercedes-Benz A 204 330 43 11        |
| Mercedes-Benz A 204 330 57 11        | Mercedes-Benz A 204 330 87 11        |
| Mercedes-Benz (BBDC) 204 330 43 11   | Mercedes-Benz (BBDC) 204 330 87 11   |
| Mercedes-Benz (BBDC) A 204 330 43 11 | Mercedes-Benz (BBDC) A 204 330 87 11 |

**Application info**

- |  |  |
|--|--|
| Mercedes-Benz BM 171 (SLK) (03/04-12/11) | Mercedes-Benz BM 172 (SLC) (01/16--)         |
| Mercedes-Benz BM 172 (SLK) (01/11--)     | Mercedes-Benz BM 203 (C-Class) (05/00-06/11) |
| Mercedes-Benz BM 204 (C-Class) (01/07--) | Mercedes-Benz BM 207 (E-Class) (01/09-12/16) |
| Mercedes-Benz BM 209 (CLK) (05/02-03/10) |  |

<b>Control arm</b>	<b>016 050 0102</b>	<b>MCA1060</b>
--------------------	---------------------	----------------

**Notes**

Aluminium  
Control Arm  
Front  
Front Axle Right  
Lower  
with rubber mount

Paired article number 016 050 0101 | MCA1059  
Required quantity 1  
replacement in pairs recommended



**References**

Mercedes-Benz 203 330 02 11	Mercedes-Benz 203 330 17 11
Mercedes-Benz 203 330 36 11	Mercedes-Benz 203 330 40 11
Mercedes-Benz 204 330 34 11	Mercedes-Benz 204 330 44 11
Mercedes-Benz 204 330 58 11	Mercedes-Benz 204 330 88 11
Mercedes-Benz A 203 330 02 11	Mercedes-Benz A 203 330 17 11
Mercedes-Benz A 203 330 36 11	Mercedes-Benz A 203 330 40 11
Mercedes-Benz A 204 330 34 11	Mercedes-Benz A 204 330 44 11
Mercedes-Benz A 204 330 58 11	Mercedes-Benz A 204 330 88 11
Mercedes-Benz (BBDC) 204 330 44 11	Mercedes-Benz (BBDC) 204 330 88 11
Mercedes-Benz (BBDC) A 204 330 44 11	Mercedes-Benz (BBDC) A 204 330 88 11

**Application info**

Mercedes-Benz BM 171 (SLK) (03/04-12/11)	Mercedes-Benz BM 172 (SLC) (01/16--)
Mercedes-Benz BM 172 (SLK) (01/11--)	Mercedes-Benz BM 203 (C-Class) (05/00-06/11)
Mercedes-Benz BM 204 (C-Class) (01/07--)	Mercedes-Benz BM 207 (E-Class) (01/09-12/16)
Mercedes-Benz BM 209 (CLK) (05/02-03/10)	

**Control arm**

**016 050 0109 MCA1330**

**Notes**

Control Arm  
 Front Axle Left  
 Steel  
 Length [mm] 347  
 Paired article number 016 050 0110 | MCA1331  
 Required quantity 1  
 Thread Size M16x1,5  
 Width [mm] 313

replacement in pairs recommended





**References**

MERCEDES-BENZ (FJDA) 447 330 14 07	MERCEDES-BENZ (FJDA) A 447 330 14 07
Mercedes-Benz 447 330 14 07	Mercedes-Benz A 447 330 14 07

**Application info**

Mercedes-Benz BM 447 (V-Class) (03/14--)	Mercedes-Benz BM 447 (Vito) (10/14--)
--	---------------------------------------

Control arm		016 050 0110	MCA1331
<p><b>Notes</b></p> <p>Control Arm Front Axle Right Steel</p> <p>Length [mm] 347 Paired article number 016 050 0109   MCA1330 Paired article number 016 050 0109/HD Required quantity 1 Thread Size M16x1,5 Width [mm] 313 replacement in pairs recommended</p>			
<p><b>References</b></p> <p>MERCEDES-BENZ (FJDA) 447 330 15 07 Mercedes-Benz 447 330 15 07</p>		<p>MERCEDES-BENZ (FJDA) A 447 330 15 07 Mercedes-Benz A 447 330 15 07</p>	
<p><b>Application info</b></p> <p>Mercedes-Benz BM 447 (V-Class) (03/14--)</p>		<p>Mercedes-Benz BM 447 (Vito) (10/14--)</p>	
Control arm		016 050 0135	MCA1335
<p><b>Notes</b></p> <p>Cast Steel Control Arm Front Axle Left Front Axle Right Lower</p> <p>Required quantity 2 replacement in pairs recommended</p>			
<p><b>References</b></p> <p>Mercedes-Benz 212 330 19 11</p>		<p>Mercedes-Benz A 212 330 19 11</p>	
<p><b>Application info</b></p> <p>Mercedes-Benz BM 212 (E-Class) (01/09-12/16)</p>		<p>Mercedes-Benz BM 218 (CLS) (01/11-12/17)</p>	

**Control arm**

016 050 0137

MCA1391

**Notes**

Control Arm  
Rear Axle Left  
Rear Axle Right  
Steel

Required quantity 2  
replacement in pairs recommended



**References**

Mercedes-Benz 124 350 54 06  
Mercedes-Benz A 124 350 54 06

Mercedes-Benz 202 350 02 06  
Mercedes-Benz A 202 350 02 06

**Application info**

Mercedes-Benz BM 124 (12/84-12/93)  
Mercedes-Benz BM 129 (SL) (03/89-09/04)  
Mercedes-Benz BM 171 (SLK) (03/04-12/11)  
Mercedes-Benz BM 172 (SLK) (01/11--)  
Mercedes-Benz BM 202 (C-Class) (03/93-03/01)  
Mercedes-Benz BM 208 (CLK) (06/97-12/03)  
Mercedes-Benz BM 210 (E-Class) (06/95-08/03)

Mercedes-Benz BM 124 (E-Class) (02/93-03/98)  
Mercedes-Benz BM 170 (SLK) (04/96-04/04)  
Mercedes-Benz BM 172 (SLC) (01/16--)  
Mercedes-Benz BM 201 (190) (10/82-08/93)  
Mercedes-Benz BM 203 (C-Class) (05/00-06/11)  
Mercedes-Benz BM 209 (CLK) (05/02-03/10)

**Control arm**

016 050 0139

MCA1306

**Notes**

Centre  
Control Arm  
Rear Axle Left  
Steel  
Upper

Paired article number 016 050 0140 | MCA1307  
Required quantity 1  
replacement in pairs recommended



**References**



Mercedes-Benz 166 350 01 06

Mercedes-Benz A 166 350 01 06



**Application info**



Mercedes-Benz BM 166 (GL) (07/12-12/15)  
Mercedes-Benz BM 166 (GLS) (11/15-04/19)

Mercedes-Benz BM 166 (GLE) (03/15-10/19)  
Mercedes-Benz BM 166 (M-Class) (06/11-12/15)

Control arm		016 050 0140	MCA1307
<p><b>Notes</b></p> <p>Centre Control Arm Rear Axle Right Steel Upper</p> <p>Paired article number 016 050 0139   MCA1306 Required quantity 1 replacement in pairs recommended</p>			
<p><b>References</b></p> <p>Mercedes-Benz 166 350 02 06</p>		<p>Mercedes-Benz A 166 350 02 06</p>	
<p><b>Application info</b></p> <p>Mercedes-Benz BM 166 (GL) (07/12-12/15) Mercedes-Benz BM 166 (GLS) (11/15-04/19)</p>		<p>Mercedes-Benz BM 166 (GLE) (03/15-10/19) Mercedes-Benz BM 166 (M-Class) (06/11-12/15)</p>	
Control arm		016 050 0141/HD	MCA1263HD
<p><b>Notes</b></p> <p>Aluminium Carbon Neutral Control Arm Front Axle Left Upper</p> <p>Paired article number 016 050 0142/HD   MCA1264HD Replace in pairs only Required quantity 1</p>			
<p><b>References</b></p> <p>Mercedes-Benz 205 330 55 01 Mercedes-Benz (BBDC) 205 330 55 01</p>		<p>Mercedes-Benz A 205 330 55 01 Mercedes-Benz (BBDC) A 205 330 55 01</p>	
<p><b>Application info</b></p> <p>Mercedes-Benz BM 205 (C-Class) (12/13--) Mercedes-Benz BM 238 (E-Class) (06/17--) Mercedes-Benz BM 257 (CLS-Class) (12/17--)</p>		<p>Mercedes-Benz BM 213 (E-Class) (01/16--) Mercedes-Benz BM 253 (GLC) (06/15--) Mercedes-Benz BM 293 (EQC) (05/19--)</p>	

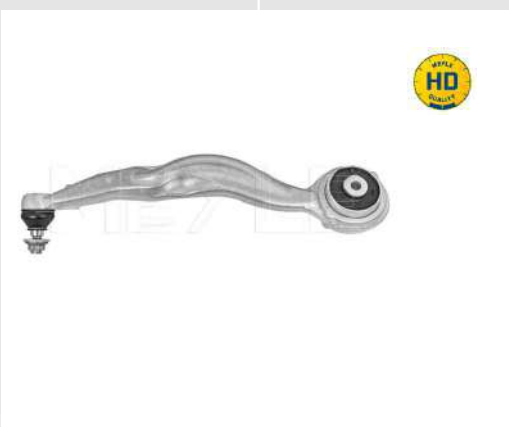

Control arm		016 050 0142/HD	MCA1264HD
<b>Notes</b>  Aluminium Carbon Neutral Control Arm Front Axle Right Upper  Paired article number 016 050 0141/HD   MCA1263HD Replace in pairs only Required quantity 1			
<b>References</b> Mercedes-Benz 205 330 56 01 Mercedes-Benz A 205 330 56 01 Mercedes-Benz (BBDC) 205 330 56 01 Mercedes-Benz (BBDC) A 205 330 56 01			
<b>Application info</b> Mercedes-Benz BM 205 (C-Class) (12/13--) Mercedes-Benz BM 238 (E-Class) (06/17--) Mercedes-Benz BM 257 (CLS-Class) (12/17--) Mercedes-Benz BM 213 (E-Class) (01/16--) Mercedes-Benz BM 253 (GLC) (06/15--) Mercedes-Benz BM 293 (EQC) (05/19--) 			
Control arm		016 050 0152/HD	MCA1275HD
<b>Notes</b>  Aluminium Carbon Neutral Control Arm Front Axle Right Lower Rear  Paired article number 016 050 0153/HD   MCA1276HD Replace in pairs only Required quantity 1			
<b>References</b> Mercedes-Benz 212 330 32 11 Mercedes-Benz A 212 330 32 11 Mercedes-Benz (BBDC) 212 330 32 11 Mercedes-Benz (BBDC) A 212 330 32 11			
<b>Application info</b> Mercedes-Benz BM 212 (E-Class) (01/09-12/16) Mercedes-Benz BM 218 (CLS) (01/11-12/17)			

Control arm		016 050 0153/HD	MCA1276HD
<b>Notes</b>  Aluminium Carbon Neutral Control Arm Front Axle Left Lower Rear  Paired article number 016 050 0152/HD   MCA1275HD Replace in pairs only Required quantity 1			
<b>References</b> Mercedes-Benz 212 330 31 11 Mercedes-Benz (BBDC) 212 330 31 11		Mercedes-Benz A 212 330 31 11 Mercedes-Benz (BBDC) A 212 330 31 11	
<b>Application info</b> Mercedes-Benz BM 212 (E-Class) (01/09-12/16)		Mercedes-Benz BM 218 (CLS) (01/11-12/17)	
Control arm		016 050 0154	MCA1292
<b>Notes</b>  Control Arm Front Rear Axle Left Rear Axle Right Steel  Required quantity 2 replacement in pairs recommended			
<b>References</b> Mercedes-Benz 166 350 03 06		Mercedes-Benz A 166 350 03 06	
<b>Application info</b> Mercedes-Benz BM 166 (GL) (07/12-12/15) Mercedes-Benz BM 166 (GLS) (11/15-04/19)		Mercedes-Benz BM 166 (GLE) (03/15-10/19) Mercedes-Benz BM 166 (M-Class) (06/11-12/15)	

**Control arm**

**016 050 0160/HD**

**MCA1298HD**

**Notes**

Aluminium  
Carbon Neutral  
Centre  
Control Arm  
Front Axle Right  
with rubber mount



Paired article number 016 050 0161  
Paired article number 016 050 0161/HD | MCA1299HD  
Replace in pairs only  
Required quantity 1

**References**

Mercedes-Benz 205 330 20 07 Mercedes-Benz 205 330 62 01  
Mercedes-Benz 205 330 66 10 Mercedes-Benz A 205 330 20 07  
Mercedes-Benz A 205 330 62 01 Mercedes-Benz A 205 330 66 10  
Mercedes-Benz (BBDC) 205 330 20 07 Mercedes-Benz (BBDC) A 205 330 20 07

**Application info**

Mercedes-Benz BM 205 (C-Class) (12/13--)  
Mercedes-Benz BM 238 (E-Class) (06/17--)

Mercedes-Benz BM 213 (E-Class) (01/16--)  
Mercedes-Benz BM 257 (CLS-Class) (12/17--)

**Control arm**

**016 050 0161/HD**

**MCA1299HD**

**Notes**

Aluminium  
Carbon Neutral  
Centre  
Control Arm  
Front Axle Left



Paired article number 016 050 0160/HD | MCA1298HD  
Paired article number 016 050 0210/HD | MCA1621HD  
Replace in pairs only  
Required quantity 1

**References**

Mercedes-Benz 205 330 19 07 Mercedes-Benz 205 330 59 01  
Mercedes-Benz 205 330 61 01 Mercedes-Benz 205 330 65 10  
Mercedes-Benz A 205 330 19 07 Mercedes-Benz A 205 330 59 01  
Mercedes-Benz A 205 330 61 01 Mercedes-Benz A 205 330 65 10  
Mercedes-Benz (BBDC) 205 330 19 07 Mercedes-Benz (BBDC) 205 330 61 01  
Mercedes-Benz (BBDC) A 205 330 19 07 Mercedes-Benz (BBDC) A 205 330 61 01

**Application info**

Mercedes-Benz BM 205 (C-Class) (12/13--)  
 Mercedes-Benz BM 238 (E-Class) (06/17--)

Mercedes-Benz BM 213 (E-Class) (01/16--)  
 Mercedes-Benz BM 257 (CLS-Class) (12/17--)

**Control arm**

016 050 0162

MCA1374

**Notes**

Rear Axle Right  
 Sheet Steel  
 Trailing Arm

Paired article number 016 050 0163 | MCA1375  
 Required quantity 1  
 replacement in pairs recommended



**References**

Mercedes-Benz 246 350 05 06

Mercedes-Benz A 246 350 05 06

**Application info**

Mercedes-Benz BM 117 (CLA) (01/13-03/19)  
 Mercedes-Benz BM 176 (A-Class) (06/12-05/18)

Mercedes-Benz BM 156 (GLA-Class) (12/13--)  
 Mercedes-Benz BM 246 (B-Class) (10/11-12/18)

**Control arm**

016 050 0163

MCA1375

**Notes**

Rear Axle Left  
 Sheet Steel  
 Trailing Arm

Paired article number 016 050 0162 | MCA1374  
 Required quantity 1  
 replacement in pairs recommended



**References**

Mercedes-Benz 246 350 04 06

Mercedes-Benz A 246 350 04 06

**Application info**

Mercedes-Benz BM 117 (CLA) (01/13-03/19)  
 Mercedes-Benz BM 176 (A-Class) (06/12-05/18)

Mercedes-Benz BM 156 (GLA-Class) (12/13--)  
 Mercedes-Benz BM 246 (B-Class) (10/11-12/18)

## Control arm

016 050 0164

MCA1287

## Notes

Centre  
Control Arm  
Rear Axle Left  
Rear Axle Right  
Steel

Length [mm]

258

Required quantity

2

replacement in pairs recommended



## References

Mercedes-Benz 172 350 01 53

Mercedes-Benz A 172 350 01 53

## Application info

Mercedes-Benz BM 172 (SLC) (01/16--)

Mercedes-Benz BM 172 (SLK) (01/11--)

## Control arm

016 050 0169/HD

MCA1376HD

## Notes

Aluminium  
Carbon Neutral  
Control Arm  
Front Axle Left  
Front Axle Right  
Lower  
Rear

Replace in pairs only

Required quantity

2

reinforced version



## References

Mercedes-Benz 205 330 45 07

Mercedes-Benz 205 330 58 01

Mercedes-Benz 205 330 67 10

Mercedes-Benz A 205 330 45 07

Mercedes-Benz A 205 330 58 01

Mercedes-Benz A 205 330 67 10

Mercedes-Benz (BBDC) 205 330 58 01

Mercedes-Benz (BBDC) A 205 330 58 01

## Application info

Mercedes-Benz BM 205 (C-Class) (12/13--)

Mercedes-Benz BM 207 (E-Class) (01/09-12/16)



Mercedes-Benz BM 213 (E-Class) (01/16--)

Mercedes-Benz BM 238 (E-Class) (06/17--)

Mercedes-Benz BM 253 (GLC) (06/15--)

Mercedes-Benz BM 257 (CLS-Class) (12/17--)

Mercedes-Benz BM 293 (EQC) (05/19--)

Control arm		016 050 0175	MCA1360
<p><b>Notes</b></p> <p>Aluminium Control Arm Front Front Axle Left Lower</p> <p>Paired article number 016 050 0176   MCA1361</p> <p>Required quantity 1</p> <p>replacement in pairs recommended</p>			
<p><b>References</b></p> <p>Mercedes-Benz 205 330 17 05 Mercedes-Benz A 205 330 17 05</p>			
<p><b>Application info</b></p> <p>Mercedes-Benz BM 205 (C-Class) (12/13--)</p> <p>Mercedes-Benz BM 238 (E-Class) (06/17--)</p> <p>Mercedes-Benz BM 293 (EQC) (05/19--)</p> <p>Mercedes-Benz BM 213 (E-Class) (01/16--)</p> <p>Mercedes-Benz BM 253 (GLC) (06/15--)</p>			
Control arm		016 050 0176	MCA1361
<p><b>Notes</b></p> <p>Aluminium Control Arm Front Front Axle Right Lower</p> <p>Paired article number 016 050 0175   MCA1360</p> <p>Required quantity 1</p> <p>replacement in pairs recommended</p>			
<p><b>References</b></p> <p>Mercedes-Benz 205 330 18 05 Mercedes-Benz A 205 330 18 05</p>			
<p><b>Application info</b></p> <p>Mercedes-Benz BM 205 (C-Class) (12/13--)</p> <p>Mercedes-Benz BM 238 (E-Class) (06/17--)</p> <p>Mercedes-Benz BM 293 (EQC) (05/19--)</p> <p>Mercedes-Benz BM 213 (E-Class) (01/16--)</p> <p>Mercedes-Benz BM 253 (GLC) (06/15--)</p>			

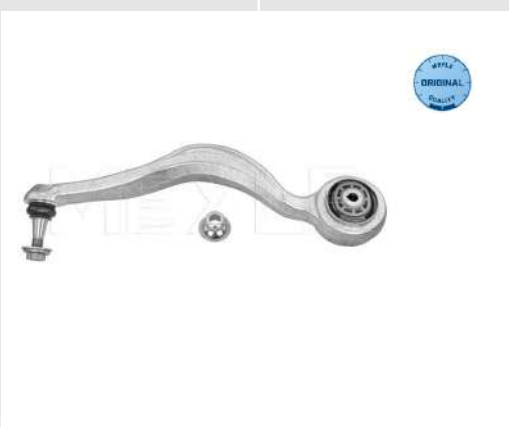
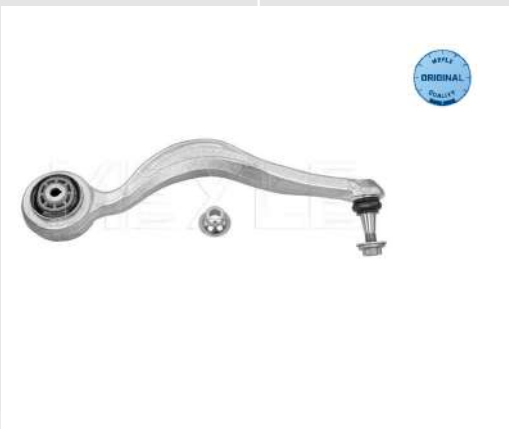
Control arm		016 050 0181	MCA1362
<p><b>Notes</b></p> <p>Aluminium Control Arm Front Front Axle Left Lower for left-hand drive vehicles</p> <p>Paired article number Required quantity replacement in pairs recommended</p>			
<p><b>References</b></p> <p>Mercedes-Benz 205 330 19 05 Mercedes-Benz (BBDC) 205 330 19 05</p>		<p>Mercedes-Benz A 205 330 19 05 Mercedes-Benz (BBDC) A 205 330 19 05</p>	
<p><b>Application info</b></p> <p>Mercedes-Benz BM 205 (C-Class) (12/13--) Mercedes-Benz BM 238 (E-Class) (06/17--)</p>		<p>Mercedes-Benz BM 213 (E-Class) (01/16--)</p>	
Control arm		016 050 0182	MCA1363
<p><b>Notes</b></p> <p>Aluminium Control Arm Front Front Axle Right Lower for left-hand drive vehicles</p> <p>Paired article number Required quantity replacement in pairs recommended</p>			
<p><b>References</b></p> <p>Mercedes-Benz 205 330 20 05 Mercedes-Benz (BBDC) 205 330 20 05</p>		<p>Mercedes-Benz A 205 330 20 05 Mercedes-Benz (BBDC) A 205 330 20 05</p>	
<p><b>Application info</b></p> <p>Mercedes-Benz BM 205 (C-Class) (12/13--) Mercedes-Benz BM 238 (E-Class) (06/17--)</p>		<p>Mercedes-Benz BM 213 (E-Class) (01/16--)</p>	

**Control arm**

016 050 0185/HD

MCA1442HD

**Notes**

Aluminium  
 Carbon Neutral  
 Control Arm  
 Front Axle Left  
 Lower  
 Length [mm] 386.4  
 Paired article number 016 050 0186/HD | MCA1443HD  
 Replace in pairs only  
 Required quantity 1  
 Thread Size M14x1,5  
 Width [mm] 366.6  
 reinforced version



**References**

- |                                      |                                      |
|--------------------------------------|--------------------------------------|
| Mercedes-Benz 177 330 03 02          | Mercedes-Benz 177 330 05 02          |
| Mercedes-Benz 177 330 73 00          | Mercedes-Benz 177 330 75 00          |
| Mercedes-Benz 247 330 05 00          | Mercedes-Benz 247 330 53 00          |
| Mercedes-Benz 247 330 73 02          | Mercedes-Benz 247 330 75 02          |
| Mercedes-Benz A 177 330 03 02        | Mercedes-Benz A 177 330 05 02        |
| Mercedes-Benz A 177 330 73 00        | Mercedes-Benz A 177 330 75 00        |
| Mercedes-Benz A 247 330 05 00        | Mercedes-Benz A 247 330 53 00        |
| Mercedes-Benz A 247 330 73 02        | Mercedes-Benz A 247 330 75 02        |
| Mercedes-Benz (BBDC) 247 330 05 00   | Mercedes-Benz (BBDC) 247 330 73 02   |
| Mercedes-Benz (BBDC) A 247 330 05 00 | Mercedes-Benz (BBDC) A 247 330 73 02 |

**Application info**

- |  |  |
|--|--|
| Mercedes-Benz BM 177 (A-Class) (03/18--) | Mercedes-Benz BM 247 (B-Class) (12/18--) |
|--|--|



**Control arm**

016 050 0186/HD

MCA1443HD

**Notes**

Aluminium  
Carbon Neutral  
Control Arm  
Front Axle Right  
Lower

Length [mm] 386.4  
Paired article number 016 050 0185/HD | MCA1442HD  
Replace in pairs only  
Required quantity 1  
Thread Size M14x1,5  
Width [mm] 366.6  
reinforced version



**References**

- |                                      |                                      |
|--------------------------------------|--------------------------------------|
| Mercedes-Benz 177 330 04 02          | Mercedes-Benz 177 330 06 02          |
| Mercedes-Benz 177 330 74 00          | Mercedes-Benz 177 330 76 00          |
| Mercedes-Benz 247 330 06 00          | Mercedes-Benz 247 330 54 00          |
| Mercedes-Benz 247 330 74 02          | Mercedes-Benz 247 330 76 02          |
| Mercedes-Benz A 177 330 04 02        | Mercedes-Benz A 177 330 06 02        |
| Mercedes-Benz A 177 330 74 00        | Mercedes-Benz A 177 330 76 00        |
| Mercedes-Benz A 247 330 06 00        | Mercedes-Benz A 247 330 54 00        |
| Mercedes-Benz A 247 330 74 02        | Mercedes-Benz A 247 330 76 02        |
| Mercedes-Benz (BBDC) 247 330 06 00   | Mercedes-Benz (BBDC) 247 330 74 02   |
| Mercedes-Benz (BBDC) A 247 330 06 00 | Mercedes-Benz (BBDC) A 247 330 74 02 |

**Application info**

Mercedes-Benz BM 177 (A-Class) (03/18--)

Mercedes-Benz BM 247 (B-Class) (12/18--)

**Control arm**

016 050 0187/HD

MCA1569HD

**Notes**

Carbon Neutral  
Control Arm  
Front Axle Left  
Lower  
Sheet Steel  
with ball joint

Length [mm] 442  
Paired article number 016 050 0188/HD | MCA1570HD  
Replace in pairs only  
Required quantity 1  
Width [mm] 390



**References**

Mercedes-Benz 910 330 25 00

Mercedes-Benz A 910 330 25 00

**Application info**

Mercedes-Benz BM 907 / 910 (Sprinter III) (02/18--)

**Control arm****016 050 0187****MCA1569****Notes**

Control Arm  
Front Axle Left  
Lower  
Sheet Steel  
without ball joint

Length [mm]

442

Paired article number

016 050 0188 | MCA1570

Required quantity

1

Width [mm]

390

replacement in pairs recommended

**References**

Mercedes-Benz 910 330 25 00

Mercedes-Benz A 910 330 25 00

**Application info**

Mercedes-Benz BM 907 / 910 (Sprinter III) (02/18--)

**Control arm****016 050 0188****MCA1570****Notes**

Control Arm  
Front Axle Right  
Lower  
Sheet Steel  
without ball joint

Length [mm]

442

Paired article number

016 050 0187 | MCA1569

Required quantity

1

Width [mm]

390

replacement in pairs recommended

**References**

Mercedes-Benz 910 330 26 00

Mercedes-Benz A 910 330 26 00

**Application info**

Mercedes-Benz BM 907 / 910 (Sprinter III) (02/18--)

Control arm		016 050 0188/HD	MCA1570HD
<b>Notes</b>  Carbon Neutral Control Arm Front Axle Right Lower Sheet Steel with ball joint  Length [mm] 442 Paired article number 016 050 0187/HD   MCA1569HD Replace in pairs only Required quantity 1 Width [mm] 390			

References	
Mercedes-Benz 910 330 26 00	Mercedes-Benz A 910 330 26 00

Application info	
Mercedes-Benz BM 907 / 910 (Sprinter III) (02/18--)	

Control arm		016 050 0189	MCA1412
<b>Notes</b>  Control Arm Front Lower Rear Axle Left Rear Axle Right Sheet Steel with rubber mount  Bore Diameter [mm] 12.2 Hole Spacing 1/Hole Spacing 2 207 Length [mm] 207 Required quantity 2 replacement in pairs recommended			

References	
Mercedes-Benz 247 350 18 00	Mercedes-Benz A 247 350 18 00
Mercedes-Benz (BBDC) 247 350 18 00	Mercedes-Benz (BBDC) A 247 350 18 00

**Application info**

Mercedes-Benz BM 118 (CLA) (03/19--)

Mercedes-Benz BM 243 (EQA) (02/21--)

Mercedes-Benz BM 247 (B-Class) (12/18--)

Mercedes-Benz BM 247 (GLB-Class) (08/19--)

Mercedes-Benz BM 177 (A-Class) (03/18--)

Mercedes-Benz BM 243 (EQB) (12/21--)

Mercedes-Benz BM 247 (GLA-Class) (02/20--)

**Control arm**

016 050 0191

MCA1366

**Notes**

Aluminium  
Control Arm  
Front  
Front Axle Left  
Lower  
for left-hand drive vehicles

Paired article number

016 050 0192 | MCA1367

Required quantity

1

replacement in pairs recommended



**References**

Mercedes-Benz 213 330 21 00

Mercedes-Benz A 213 330 21 00

**Application info**

Mercedes-Benz BM 213 (E-Class) (01/16--)

Mercedes-Benz BM 257 (CLS-Class) (12/17--)

**Control arm**

016 050 0192

MCA1367

**Notes**

Aluminium  
Control Arm  
Front  
Front Axle Right  
Lower  
for left-hand drive vehicles

Paired article number

016 050 0191 | MCA1366

Required quantity

1

replacement in pairs recommended



**References**

Mercedes-Benz 213 330 22 00

Mercedes-Benz A 213 330 22 00

**Application info**

Mercedes-Benz BM 213 (E-Class) (01/16--)

Mercedes-Benz BM 257 (CLS-Class) (12/17--)

<b>Control arm</b>	<b>016 050 0194/HD</b>	<b>MCA1355HD</b>
--------------------	------------------------	------------------

<p><b>Notes</b></p> <p>Aluminium Carbon Neutral Control Arm Front Axle Right Lower Rear</p> <p>Paired article number Replace in pairs only Required quantity reinforced version</p>	<p>016 050 0195/HD   MCA1356HD</p> <p>1</p>	
---	---	---

<b>References</b>	
Mercedes-Benz 218 330 12 11	Mercedes-Benz A 218 330 12 11



<b>Application info</b>
Mercedes-Benz BM 218 (CLS) (01/11-12/17)





<b>Control arm</b>	<b>016 050 0195/HD</b>	<b>MCA1356HD</b>
--------------------	------------------------	------------------



<p><b>Notes</b></p> <p>Aluminium Carbon Neutral Control Arm Front Axle Left Lower Rear</p> <p>Paired article number Replace in pairs only Required quantity reinforced version</p>	<p>1</p>	
--	----------	---

<b>References</b>	
Mercedes-Benz 218 330 11 11	Mercedes-Benz A 218 330 11 11





<b>Application info</b>
Mercedes-Benz BM 218 (CLS) (01/11-12/17)

Control arm		016 050 0196	MCA1473
<p><b>Notes</b></p> <p>Control Arm Front Front Axle Right Lower Steel without ball joint</p> <p>Length [mm] 367.4 Paired article number 016 050 0197   MCA1474 Required quantity 1 replacement in pairs recommended</p>			
<p><b>References</b></p> <p>Mercedes-Benz 218 330 08 11 Mercedes-Benz 218 330 74 00 Mercedes-Benz A 218 330 08 11 Mercedes-Benz A 218 330 74 00</p>			
<p><b>Application info</b></p> <p>Mercedes-Benz BM 212 (E-Class) (01/09-12/16) Mercedes-Benz BM 218 (CLS) (01/11-12/17)</p>			
Control arm		016 050 0197	MCA1474
<p><b>Notes</b></p> <p>Control Arm Front Front Axle Left Lower Steel without ball joint</p> <p>Length [mm] 367.4 Paired article number 016 050 0196   MCA1473 Required quantity 1 replacement in pairs recommended</p>			
<p><b>References</b></p> <p>Mercedes-Benz 218 330 07 11 Mercedes-Benz 218 330 73 00 Mercedes-Benz A 218 330 07 11 Mercedes-Benz A 218 330 73 00</p>			
<p><b>Application info</b></p> <p>Mercedes-Benz BM 212 (E-Class) (01/09-12/16) Mercedes-Benz BM 218 (CLS) (01/11-12/17)</p>			

Control arm		016 050 0198	MCA1504
<p><b>Notes</b></p> <p>Aluminium Rear Axle Right Semi-Trailing Arm</p> <p>Bore Diameter [mm] 12.2 Length [mm] 371.8 Paired article number 016 050 0199   MCA1505 Required quantity 1 replacement in pairs recommended</p>		 	
<p><b>References</b></p> <p>Mercedes-Benz 167 350 10 01 Mercedes-Benz A 167 350 10 01</p>			
<p><b>Application info</b></p> <p>Mercedes-Benz BM 167 (GLE) (10/18--)</p>			
Control arm		016 050 0199	MCA1505
<p><b>Notes</b></p> <p>Aluminium Rear Axle Left Semi-Trailing Arm</p> <p>Bore Diameter [mm] 12.2 Length [mm] 371.8 Paired article number 016 050 0198   MCA1504 Required quantity 1 replacement in pairs recommended</p>		 	
<p><b>References</b></p> <p>Mercedes-Benz 167 350 09 01 Mercedes-Benz A 167 350 09 01</p>			
<p><b>Application info</b></p> <p>Mercedes-Benz BM 167 (GLE) (10/18--)</p>			

Control arm		016 050 0203	MCA1486
<b>Notes</b>  Aluminium Control Arm Front Rear Axle Left  Paired article number 016 050 0204   MCA1487 Required quantity 1 replacement in pairs recommended			
<b>References</b> Mercedes-Benz 167 350 29 00		Mercedes-Benz A 167 350 29 00	
<b>Application info</b> Mercedes-Benz BM 167 (GLE) (10/18--)		Mercedes-Benz BM 167 (GLS) (04/19--)	
Control arm		016 050 0204	MCA1487
<b>Notes</b>  Aluminium Control Arm Front Rear Axle Right  Paired article number 016 050 0203   MCA1486 Required quantity 1 replacement in pairs recommended			
<b>References</b> Mercedes-Benz 167 350 30 00		Mercedes-Benz A 167 350 30 00	
<b>Application info</b> Mercedes-Benz BM 167 (GLE) (10/18--)		Mercedes-Benz BM 167 (GLS) (04/19--)	



Control arm		016 050 0205	MCA1535
<b>Notes</b>  Control Arm Rear Rear Axle Left Rear Axle Right Steel Pipe  Required quantity replacement in pairs recommended		 	
<b>References</b> Mercedes-Benz 167 350 25 00		Mercedes-Benz A 167 350 25 00	
<b>Application info</b> Mercedes-Benz BM 167 (GLE) (10/18--)		Mercedes-Benz BM 167 (GLS) (04/19--)	
Control arm		016 050 0210/HD	MCA1621HD
<b>Notes</b>  Aluminium Carbon Neutral Centre Control Arm Front Axle Right with ball joints  Paired article number Paired article number Replace in pairs only Required quantity		 	
<b>References</b> Mercedes-Benz 205 330 22 07 Mercedes-Benz A 205 330 22 07 Mercedes-Benz (BBDC) 205 330 22 07 Mercedes-Benz (BBDC) A 205 330 22 07		Mercedes-Benz 205 330 64 01 Mercedes-Benz A 205 330 64 01 Mercedes-Benz (BBDC) 205 330 64 01 Mercedes-Benz (BBDC) A 205 330 64 01	
<b>Application info</b> Mercedes-Benz BM 205 (C-Class) (12/13--) Mercedes-Benz BM 238 (E-Class) (06/17--)		Mercedes-Benz BM 213 (E-Class) (01/16--) Mercedes-Benz BM 257 (CLS-Class) (12/17--)	

**Control arm**

016 050 0211/HD

MCA1622HD

**Notes**

Aluminium  
 Carbon Neutral  
 Centre  
 Control Arm  
 Front Axle Left  
 Paired article number 016 050 0210/HD | MCA1621HD  
 Replace in pairs only  
 Required quantity 1



**References**

Mercedes-Benz 205 330 21 07	Mercedes-Benz 205 330 63 01
Mercedes-Benz A 205 330 21 07	Mercedes-Benz A 205 330 63 01
Mercedes-Benz (BBDC) 205 330 21 07	Mercedes-Benz (BBDC) 205 330 63 01
Mercedes-Benz (BBDC) A 205 330 21 07	Mercedes-Benz (BBDC) A 205 330 63 01

**Application info**

Mercedes-Benz BM 205 (C-Class) (12/13--)	Mercedes-Benz BM 213 (E-Class) (01/16--)
Mercedes-Benz BM 238 (E-Class) (06/17--)	Mercedes-Benz BM 257 (CLS-Class) (12/17--)

**Control arm**

016 050 2103/HD

MCA0058HD

**Notes**

Carbon Neutral  
 Control Arm  
 Front Axle Left  
 Sheet Steel  
 Upper  
 with rubber mount  
 Paired article number 016 050 2104/HD | MCA0059HD  
 Replace in pairs only  
 Required quantity 1  
 reinforced version



**References**

Chrysler 05101056AA  
 Mercedes-Benz 202 330 48 07  
 Mercedes-Benz 208 330 13 07  
 Mercedes-Benz 210 330 13 07  
 Mercedes-Benz 210 330 25 07  
 Mercedes-Benz 210 330 50 07  
 Mercedes-Benz A 202 330 48 07  
 Mercedes-Benz A 208 330 13 07  
 Mercedes-Benz A 210 330 13 07  
 Mercedes-Benz A 210 330 25 07  
 Mercedes-Benz A 210 330 50 07

Chrysler 5101056AA  
 Mercedes-Benz 208 330 04 07  
 Mercedes-Benz 210 330 04 07  
 Mercedes-Benz 210 330 22 07  
 Mercedes-Benz 210 330 48 07  
 Mercedes-Benz 210 330 87 07  
 Mercedes-Benz A 208 330 04 07  
 Mercedes-Benz A 210 330 04 07  
 Mercedes-Benz A 210 330 22 07  
 Mercedes-Benz A 210 330 48 07  
 Mercedes-Benz A 210 330 87 07

**Application info**

Chrysler Crossfire (07/03-12/08)  
 Mercedes-Benz BM 202 (C-Class) (03/93-03/01)  
 Mercedes-Benz BM 210 (E-Class) (06/95-08/03)

Mercedes-Benz BM 170 (SLK) (04/96-04/04)  
 Mercedes-Benz BM 208 (CLK) (06/97-12/03)

**Control arm**

016 050 2104/HD

MCA0059HD

**Notes**

Carbon Neutral  
 Control Arm  
 Front Axle Right  
 Sheet Steel  
 Upper  
 with rubber mount  
 Paired article number 016 050 2103/HD | MCA0058HD

Replace in pairs only  
 Required quantity 1  
 reinforced version



**References**

- |                               |                               |
|-------------------------------|-------------------------------|
| Chrysler 05101057AA           | Chrysler 5101057AA            |
| Mercedes-Benz 202 330 49 07   | Mercedes-Benz 208 330 05 07   |
| Mercedes-Benz 208 330 14 07   | Mercedes-Benz 210 330 05 07   |
| Mercedes-Benz 210 330 14 07   | Mercedes-Benz 210 330 23 07   |
| Mercedes-Benz 210 330 26 07   | Mercedes-Benz 210 330 37 07   |
| Mercedes-Benz 210 330 49 07   | Mercedes-Benz 210 330 51 07   |
| Mercedes-Benz 210 330 88 07   | Mercedes-Benz A 202 330 49 07 |
| Mercedes-Benz A 208 330 05 07 | Mercedes-Benz A 208 330 14 07 |
| Mercedes-Benz A 210 330 05 07 | Mercedes-Benz A 210 330 14 07 |
| Mercedes-Benz A 210 330 23 07 | Mercedes-Benz A 210 330 26 07 |
| Mercedes-Benz A 210 330 37 07 | Mercedes-Benz A 210 330 49 07 |
| Mercedes-Benz A 210 330 51 07 | Mercedes-Benz A 210 330 88 07 |

**Application info**

- |  |  |
|--|--|
| Chrysler Crossfire (07/03-12/08)             | Mercedes-Benz BM 170 (SLK) (04/96-04/04) |
| Mercedes-Benz BM 202 (C-Class) (03/93-03/01) | Mercedes-Benz BM 208 (CLK) (06/97-12/03) |
| Mercedes-Benz BM 210 (E-Class) (06/95-08/03) |  |

**Control arm**

016 050 6336 MCA0064

**Notes**

Aluminium  
Control Arm  
Front Axle Left  
Upper  
with rubber mount  
Paired article number 016 050 6337 | MCA0065  
Required quantity 1  
replacement in pairs recommended



**References**

- |                               |                               |
|-------------------------------|-------------------------------|
| Mercedes-Benz 140 330 54 07   | Mercedes-Benz 140 330 58 07   |
| Mercedes-Benz 140 330 76 07   | Mercedes-Benz A 140 330 54 07 |
| Mercedes-Benz A 140 330 58 07 | Mercedes-Benz A 140 330 76 07 |

**Application info**

- Mercedes-Benz BM 140 (S-Class) (02/91-12/99)

**Control arm**

016 050 6337

MCA0065

**Notes**

Aluminium  
Control Arm  
Front Axle Right  
Upper  
with rubber mount  
Paired article number 016 050 6336 | MCA0064  
Required quantity 1  
replacement in pairs recommended



**References**

Mercedes-Benz 140 330 55 07	Mercedes-Benz 140 330 59 07
Mercedes-Benz 140 330 77 07	Mercedes-Benz A 140 330 55 07
Mercedes-Benz A 140 330 59 07	Mercedes-Benz A 140 330 77 07

**Application info**

Mercedes-Benz BM 140 (S-Class) (02/91-12/99)

**Control arm**

100 407 0003/S

MCA0073

**Notes**

Control Arm  
Front Axle Left  
Front Axle Right  
Lower  
Set  
Sheet Steel  
with ball joint  
with rubber mount  
with suspension rod

Cone Size [mm] 19  
Required quantity 2  
replacement in pairs recommended



**References**

Seat 191 407 151 B	Volkswagen 191 407 151 B
Volkswagen 191 407 153	

**Application info**

Seat Ibiza II / Cordoba I / Inca (6K\_) (02/93-11/03)  
 Volkswagen Caddy II (9K9, 9K9B, 9U7) (11/95-06/09)  
 Volkswagen Golf II (19E) (08/83-12/92)  
 Volkswagen Polo (6K\_) (01/95-11/09)

Seat Toledo I (1L\_) (01/91-10/99)  
 Volkswagen Corrado (53I) (08/87-12/95)  
 Volkswagen Jetta II (19E) (08/83-12/92)

**Control arm**

100 407 0016

MCA0074

**Notes**

Control Arm  
 Front Axle Left  
 Front Axle Right  
 Lower  
 Sheet Steel  
 without bearing

Required quantity  
 replacement in pairs recommended

2



**References**

Porsche 171 407 153 D

Volkswagen 171 407 153 D

**Application info**

Porsche 924 (11/75-08/89)  
 Volkswagen Caddy I (14) (08/79-07/92)  
 Volkswagen Jetta I (16) (08/78-12/87)  
 Volkswagen Scirocco II (53B) (08/80-07/92)

Porsche 944 (06/81-07/91)  
 Volkswagen Golf I (17, 155) (04/74-08/93)  
 Volkswagen Scirocco I (53) (02/74-07/80)

**Control arm**

11-16 050 0003/HD

MCA0076HD

**Notes**

Carbon Neutral  
 Control Arm  
 Front Axle Right  
 Lower  
 Sheet Steel  
 for vehicles with power steering  
 with ball joint  
 with rubber mount

Paired article number 11-16 050 0004/HD | MCA0077HD

Replace in pairs only

Required quantity  
 reinforced version

1



**References**

Peugeot 16 144 473 80	Peugeot 3521.55
Peugeot 3521.56	Peugeot 3521.68
Peugeot 3521.E3	Peugeot 3521.E4
Peugeot 3521.E5	

**Application info**

Peugeot 306 (01/93-10/03)

**Control arm**

11-16 050 0004/HD

MCA0077HD

**Notes**

Carbon Neutral  
Control Arm  
Front Axle Left  
Lower  
Sheet Steel  
for vehicles with power steering  
with ball joint  
with rubber mount

Paired article number 11-16 050 0003/HD | MCA0076HD  
Paired article number 11-16 050 0070  
Replace in pairs only  
Required quantity 1  
reinforced version



**References**

Peugeot 16 144 472 80	Peugeot 3520.83
Peugeot 3520.84	Peugeot 3520.98
Peugeot 3520.99	Peugeot 3520.F3
Peugeot 3520.H3	Peugeot 3520.H4

**Application info**

Peugeot 306 (01/93-10/03)

**Control arm**

11-16 050 0007/HD

MCA0078HD

**Notes**

Carbon Neutral  
Control Arm  
Front Axle Right  
Lower  
Steel  
with ball joint  
with rubber mount

Paired article number 11-16 050 0008/HD | MCA0079HD

Replace in pairs only

Required quantity 1  
reinforced version



**References**

- |                 |                 |
|-----------------|-----------------|
| Peugeot 3521.S1 | Peugeot 3521.C8 |
| Peugeot 3521.E7 | Peugeot 3521.H9 |
| Peugeot 3521.J0 | Peugeot 3521.K2 |
| Peugeot 3521.P4 | Peugeot 3521.P5 |
| Peugeot 3521.R7 | Peugeot 3521.R9 |

**Application info**

Peugeot 206 (08/98--)

**Control arm**

11-16 050 0008/HD

MCA0079HD

**Notes**

Carbon Neutral  
Control Arm  
Front Axle Left  
Lower  
Steel  
with ball joint  
with rubber mount

Paired article number 11-16 050 0007/HD | MCA0078HD

Replace in pairs only

Required quantity 1  
reinforced version





**References**

Peugeot 3520.G8  
 Peugeot 3520.L7  
 Peugeot 3520.P2  
 Peugeot 3520.S4  
 Peugeot 3520.V7  
 Peugeot 3528.V6

Peugeot 3520.H7  
 Peugeot 3520.L8  
 Peugeot 3520.S3  
 Peugeot 3520.V6  
 Peugeot 3520.W0  
 Peugeot 3528.W8

**Application info**

Peugeot 206 (08/98--)

**Control arm**

11-16 050 0009/HD

MCA0080HD

**Notes**

Carbon Neutral  
 Control Arm  
 Front Axle Right  
 Lower  
 Steel  
 with rubber mount

Paired article number  
 Replace in pairs only  
 Required quantity  
 reinforced version

11-16 050 0010/HD | MCA0081HD

1

**References**

CITROËN (DF-PSA) 3521.G8  
 Citroën 16 431 889 80  
 Citroën 3521.K3  
 Peugeot 16 43 188 980  
 Peugeot 3521.G8  
 Peugeot 3521.K3  
 Peugeot (DF-PSA) 3521.G8

CITROËN (DF-PSA) 3521.P3  
 Citroën 3521.G8  
 Citroën 3521.P3  
 Peugeot 3521 Q1  
 Peugeot 3521.J5  
 Peugeot 3521.P3  
 Peugeot (DF-PSA) 3521.P3

**Application info**

Citroën Berlingo II (04/08--)

Peugeot 307 (08/00-12/12)

Citroën C4 I / Coupe / Grand Picasso / Picasso / Stufenheck  
 (11/04--)

Peugeot Partner II (04/08--)

## Control arm

11-16 050 0010/HD

MCA0081HD

## Notes

Carbon Neutral  
Control Arm  
Front Axle Left  
Lower  
Steel

with rubber mount

11-16 050 0009/HD | MCA0080HD

Paired article number

Replace in pairs only

Required quantity  
reinforced version

1



## References

CITROËN (DF-PSA) 3520.K8

Citroën 16 431 885 80

Citroën 3520.P3

Peugeot 16 43 188 580

Peugeot 3520.N5

Peugeot 3520.S2

Peugeot (DF-PSA) 3520.K8

CITROËN (DF-PSA) 3520.S2

Citroën 3520.K8

Citroën 3520.S2

Peugeot 3520.K8

Peugeot 3520.P3

Peugeot 3520.T0

Peugeot (DF-PSA) 3520.S2

## Application info

Citroën Berlingo II (04/08--)

Peugeot 307 (08/00-12/12)

Citroën C4 I / Coupe / Grand Picasso / Picasso / Stufenheck  
(11/04--)

Peugeot Partner II (04/08--)

## Control arm

11-16 050 0013

MCA0082

## Notes

Control Arm  
Front Axle Right  
Lower  
Steel

with rubber mount

11-16 050 0023 | MCA0089

Paired article number

Required quantity

replacement in pairs recommended

1



**References**

Citroën 3521.64  
 Citroën 3521.85  
 Citroën 3521.K4  
 Fiat 1313084080  
 Fiat 1317390080  
 Fiat 1333755080  
 Fiat 71737048  
 Lancia 1313084080  
 Lancia 1317390080  
 Lancia 1333755080  
 Peugeot 3521.64  
 Peugeot 3521.85  
 Peugeot 3521.K4

Citroën 3521.83  
 Citroën 3521.C9  
 Citroën 3521.L0  
 Fiat 1316736080  
 Fiat 1322664080  
 Fiat 1356066080  
 Fiat 93500973  
 Lancia 1316736080  
 Lancia 1322664080  
 Lancia 71737048  
 Peugeot 3521.83  
 Peugeot 3521.C9  
 Peugeot 3521.L0

**Application info**

Citroën Evasion (03/94-10/02)  
 Fiat Scudo I (220) (02/96-12/06)  
 Lancia Zeta (05/95-10/03)  
 Peugeot Expert I (07/95-03/08)

Citroën Jumpy I (06/94-12/06)  
 Fiat Ulysse I (220) (06/94-08/02)  
 Peugeot 806 (06/94-02/03)

**Control arm****11-16 050 0014****MCA0083****Notes**

Control Arm  
 Front Axle Right  
 Lower  
 Steel  
 with rubber mount

Paired article number

11-16 050 0047 | MCA0104

Required quantity

1

replacement in pairs recommended

**References**

Citroën 3521.65  
 Citroën 3521.J3  
 Fiat 1339467080  
 Peugeot 3521.65  
 Peugeot 3521.J3

Citroën 3521.H2  
 Fiat 1320787080  
 Peugeot 16 07 301 180  
 Peugeot 3521.H2

**Application info**

Citroën Jumper I (02/94-08/02)  
 Fiat Ducato (230) (03/94-05/05)  
 Peugeot Boxer I (03/94-08/05)

Citroën Jumper II (02/02--)  
 Fiat Ducato (244) (04/02--)  
 Peugeot Boxer II (12/01--)

Control arm		11-16 050 0015/HD	MCA0084HD
<b>Notes</b>	Carbon Neutral Control Arm Front Axle Left Lower Sheet Steel with ball joint with rubber mount		
Paired article number	11-16 050 0017/HD   MCA0086HD		
Replace in pairs only Required quantity reinforced version	1		

<b>References</b>	Peugeot 3520.F1
-------------------	-----------------

<b>Application info</b>	Peugeot 306 (01/93-10/03)
-------------------------	---------------------------

Control arm		11-16 050 0017/HD	MCA0086HD
<b>Notes</b>	Carbon Neutral Control Arm Front Axle Right Lower Sheet Steel with ball joint with rubber mount		
Paired article number	11-16 050 0015/HD   MCA0084HD		
Replace in pairs only Required quantity reinforced version	1		

<b>References</b>	Peugeot 3521.69	Peugeot 3521.A1
-------------------	-----------------	-----------------

<b>Application info</b>	Peugeot 306 (01/93-10/03)
-------------------------	---------------------------

**Control arm**

11-16 050 0023

MCA0089

**Notes**

Control Arm  
 Front Axle Left  
 Lower  
 Steel  
 with rubber mount







Paired article number 11-16 050 0013 | MCA0082  
 Required quantity 1  
 replacement in pairs recommended







**References**

Citroën 3520.94	Citroën 3520.C3
Citroën 3520.C5	Citroën 3520.G9
Citroën 3520.P4	Citroën 3520.P8
Fiat 1313083080	Fiat 1316735080
Fiat 1317389080	Fiat 1322663080
Fiat 1333754080	Fiat 1356065080
Fiat 71737047	Fiat 93500972
Lancia 1313083080	Lancia 1316735080
Lancia 1317389080	Lancia 1322663080
Lancia 1333754080	Lancia 71737047
Peugeot 3520.94	Peugeot 3520.C3
Peugeot 3520.C5	Peugeot 3520.C9
Peugeot 3520.G9	Peugeot 3520.P4
Peugeot 3520.P8	

**Application info**

Citroën Evasion (03/94-10/02)	Citroën Jumpy I (06/94-12/06)
Fiat Scudo I (220) (02/96-12/06)	Fiat Ulysse I (220) (06/94-08/02)
Lancia Zeta (05/95-10/03)	Peugeot 806 (06/94-02/03)
Peugeot Expert I (07/95-03/08)	

Control arm		11-16 050 0030	MCA0094
<b>Notes</b>  Paired article number Required quantity replacement in pairs recommended		Control Arm Front Axle Right Lower Steel with rubber mount 11-16 050 0031   MCA0095 1	  
<b>References</b> Citroën 3521.L2 Peugeot 3520.S8 Peugeot 3521.J6 Peugeot 3521.J7			
<b>Application info</b> Citroën C6 (09/05-12/12) Peugeot 407 (02/04--) Peugeot 508 I (11/10--)			
Control arm		11-16 050 0031	MCA0095
<b>Notes</b>  Paired article number Required quantity replacement in pairs recommended		Control Arm Front Axle Left Lower Steel with rubber mount 11-16 050 0030   MCA0094 1	  
<b>References</b> Citroën 3520.Q1 Citroën 96 502 568 80 Peugeot 3520.N6 Peugeot 3520.N7 Peugeot 96 50 256 880			
<b>Application info</b> Citroën C6 (09/05-12/12) Peugeot 407 (02/04--) Peugeot 508 I (11/10--)			

Control arm		11-16 050 0032	MCA0096
<b>Notes</b>  Paired article number Required quantity replacement in pairs recommended		Control Arm Front Axle Left Lower Steel with rubber mount 11-16 050 0033   MCA0097 1	  
<b>References</b> Citroën 3520.96 Citroën 3520.N4 Fiat 1317238080 Fiat 1331937080 Peugeot 3520.96 Peugeot 3520.N4			
<b>Application info</b> Citroën Jumper I (02/94-08/02) Fiat Ducato (230) (03/94-05/05) Peugeot Boxer I (03/94-08/05)			
<b>Control arm</b>		11-16 050 0033	MCA0097
<b>Notes</b>  Paired article number Required quantity replacement in pairs recommended		Control Arm Front Axle Right Lower Steel with rubber mount 11-16 050 0032   MCA0096 1	  
<b>References</b> Citroën 3521.66 Citroën 3521.J4 Fiat 1317239080 Fiat 1331939080 Peugeot 3521.66 Peugeot 3521.J4			

**Application info**

Citroën Jumper I (02/94-08/02)  
 Fiat Ducato (230) (03/94-05/05)  
 Peugeot Boxer I (03/94-08/05)

Citroën Jumper II (02/02--)  
 Fiat Ducato (244) (04/02--)  
 Peugeot Boxer II (12/01--)

**Control arm**

**11-16 050 0036/HD**

**MCA0098HD**

**Notes**

Carbon Neutral  
 Control Arm  
 Front Axle Left  
 Lower  
 Sheet Steel  
 with ball joint  
 with rubber mount



Paired article number 11-16 050 0037/HD | MCA0099HD  
 Replace in pairs only  
 Required quantity 1  
 reinforced version

**References**

Citroën 3520.F7  
 Citroën 95 685 512

Citroën 3520.F8  
 Peugeot 3520.H5

**Application info**

Citroën Berlingo I (07/96-12/11)  
 Citroën Xsara Picasso (09/99-06/12)  
 Peugeot Partner II (04/08--)

Citroën Xsara (04/97-03/10)  
 Peugeot Partner I (05/96--)

**Control arm**

**11-16 050 0037/HD**

**MCA0099HD**

**Notes**

Carbon Neutral  
 Control Arm  
 Front Axle Right  
 Lower  
 Sheet Steel  
 with ball joint  
 with rubber mount



Paired article number 11-16 050 0036/HD | MCA0098HD  
 Replace in pairs only  
 Required quantity 1  
 reinforced version



**References**

Citroën 3521.A7  
Citroën 95 685 513

Citroën 3521.A8  
Peugeot 3521.E5

**Application info**

Citroën Berlingo I (07/96-12/11)  
Citroën Xsara Picasso (09/99-06/12)  
Peugeot Partner II (04/08--)

Citroën Xsara (04/97-03/10)  
Peugeot Partner I (05/96--)

**Control arm****11-16 050 0038****MCA0100****Notes**

Control Arm  
Front Axle Left  
Lower  
Steel  
with rubber mount

Paired article number  
Required quantity  
replacement in pairs recommended

11-16 050 0039 | MCA0101  
1

**References**

Citroën 3520.P6  
Fiat 1346384080  
Lancia 1346384080  
Peugeot 3520.P6

Citroën 3521.H0  
Fiat 93501487  
Lancia 93501487  
Peugeot 3521.H0

**Application info**

Citroën C8 (06/02--)  
Lancia Phedra (09/02-11/10)

Fiat Ulysse II (179) (08/02-06/11)  
Peugeot 807 (06/02--)

**Control arm****11-16 050 0039****MCA0101****Notes**

Control Arm  
Front Axle Right  
Lower  
Steel  
with rubber mount

Paired article number  
Required quantity  
replacement in pairs recommended

11-16 050 0038 | MCA0100  
1



**References**

Citroën 3521.H1

Fiat 134 638 5080

Lancia 1346385080

Peugeot 3521.H1

Citroën 3521.K6

Fiat 93501488

Lancia 93501488

Peugeot 3521.K6

**Application info**

Citroën C8 (06/02--)

Lancia Phedra (09/02-11/10)

Fiat Ulysse II (179) (08/02-06/11)

Peugeot 807 (06/02--)

**Control arm**

11-16 050 0040

MCA0102

**Notes**

Control Arm  
 Front Axle Left  
 Lower  
 Steel  
 with rubber mount

Paired article number  
 Required quantity  
 replacement in pairs recommended

11-16 050 0041 | MCA0103  
 1

**References**

Citroën 3520.K3

Citroën 3520.P0

**Application info**

Citroën C5 I / C5 II (03/01--)

**Control arm**

11-16 050 0041

MCA0103

**Notes**

Control Arm  
 Front Axle Right  
 Lower  
 Steel  
 with rubber mount

Paired article number  
 Required quantity  
 replacement in pairs recommended

11-16 050 0040 | MCA0102  
 1

**References**

Citroën 3521.G3

Citroën 3521.K0

**Application info**

Citroën C5 I / C5 II (03/01--)

**Control arm**

11-16 050 0047

MCA0104

**Notes**

Control Arm  
Front Axle Left  
Lower  
Steel  
with rubber mount

Paired article number

11-16 050 0014 | MCA0083

Required quantity

1

replacement in pairs recommended

**References**

Citroën 3520.95

Citroën 3520.L0

Citroën 3520.N3

Fiat 1320786080

Fiat 1339465080

Peugeot 16 07 301 280

Peugeot 3520.95

Peugeot 3520.L0

Peugeot 3520.N3

**Application info**

Citroën Jumper I (02/94-08/02)

Citroën Jumper II (02/02--)

Fiat Ducato (230) (03/94-05/05)

Fiat Ducato (244) (04/02--)

Peugeot Boxer I (03/94-08/05)

Peugeot Boxer II (12/01--)

**Control arm**

11-16 050 0048/HD

MCA0105HD

**Notes**

Carbon Neutral  
Control Arm  
Front Axle Left  
Lower  
Steel  
with rubber mount

Paired article number

11-16 050 0049/HD | MCA0106HD

Replace in pairs only

Required quantity

1

reinforced version



**References**

CITROËN (DF-PSA) 3520.V3  
 Citroën 3520.J3  
 Citroën 3520.K9  
 Citroën 3520.Q4  
 Citroën 3520.Q8  
 Citroën 3520.V4  
 Peugeot 3520.J3  
 Peugeot 3520.Q5  
 Peugeot (DF-PSA) 3520.V3

Citroën 16 073 141 80  
 Citroën 3520.J4  
 Citroën 3520.Q3  
 Citroën 3520.Q5  
 Citroën 3520.V3  
 Peugeot 16 07 314 180  
 Peugeot 3520.Q3  
 Peugeot 3520.V3

**Application info**

Citroën Berlingo I (07/96-12/11)  
 Peugeot Partner I (05/96--)

Citroën Xsara Picasso (09/99-06/12)  
 Peugeot Partner II (04/08--)

**Control arm****11-16 050 0049/HD****MCA0106HD****Notes**

Carbon Neutral  
 Control Arm  
 Front Axle Right  
 Lower  
 Steel  
 with rubber mount

Paired article number  
 Replace in pairs only  
 Required quantity  
 reinforced version

11-16 050 0048/HD | MCA0105HD

1

**References**

CITROËN (DF-PSA) 3521.R4  
 Citroën 3521.F3  
 Citroën 3521.L4  
 Citroën 3521.L6  
 Citroën 3521.R4  
 Peugeot 16 07 314 280  
 Peugeot 3521.L4  
 Peugeot 3521.R4

Citroën 16 073 142 80  
 Citroën 3521.F4  
 Citroën 3521.L5  
 Citroën 3521.L9  
 Citroën 3521.R5  
 Peugeot 3521.F3  
 Peugeot 3521.L6  
 Peugeot (DF-PSA) 3521.R4

**Application info**

Citroën Berlingo I (07/96-12/11)  
 Peugeot Partner I (05/96--)

Citroën Xsara Picasso (09/99-06/12)  
 Peugeot Partner II (04/08--)

## Control arm

11-16 050 0052

MCA0107

## Notes

Control Arm  
Front Axle Right  
Lower  
Sheet Steel  
with ball joint  
with rubber mount

Paired article number

11-16 050 0053 | MCA0108

Required quantity

1

replacement in pairs recommended



## References

Citroën 16 073 051 80

Citroën 3521.N8

Citroën 98 105 881 80

Peugeot 16 073 051 80

Peugeot 3521 S8

Peugeot 3521.Q2

Citroën 3521 N0

Citroën 3521.S8

DS 98 105 881 80

Peugeot 3521 N0

Peugeot 3521.N8

Peugeot 98 10 588 180

## Application info

Citroën C3 III (07/16--)

Citroën C4 Cactus (09/14--)

DS DS 3 (04/15-07/19)

Peugeot 207 (02/06--)

Citroën C3 Picasso (02/09--)

Citroën DS3 (11/09-12/16)

Peugeot 208 I (03/13--)

Peugeot 208 I (03/12--)

## Control arm

11-16 050 0053

MCA0108

## Notes

Control Arm  
Front Axle Left  
Lower  
Sheet Steel  
with ball joint  
with rubber mount

Paired article number

11-16 050 0052 | MCA0107

Required quantity

1

replacement in pairs recommended



**References**

Citroën 16 073 050 80  
 Citroën 3520.R7  
 Citroën 98 105 882 80  
 Peugeot 16 073 050 80  
 Peugeot 3520 W5  
 Peugeot 3520.T1

Citroën 3520 Q9  
 Citroën 3520.W5  
 DS 98 105 882 80  
 Peugeot 3520 Q9  
 Peugeot 3520.R7  
 Peugeot 98 10 588 280

**Application info**

Citroën C3 III (07/16--)  
 Citroën C4 Cactus (09/14--)  
 DS DS 3 (04/15-07/19)  
 Peugeot 207 (02/06--)

Citroën C3 Picasso (02/09--)  
 Citroën DS3 (11/09-12/16)  
 Peugeot 2008 I (03/13--)  
 Peugeot 208 I (03/12--)

**Control arm****11-16 050 0065****MCA0111****Notes**

Control Arm  
 Front Axle Right  
 Lower  
 Steel  
 with rubber mount  
 Paired article number 11-16 050 0066 | MCA0112  
 Required quantity 1  
 replacement in pairs recommended

**References**

Citroën 3521.P1  
 Fiat 1352225080  
 Fiat 6001070755  
 Peugeot 16 109 349 80  
 Peugeot 3521.P2

Citroën 3521.P2  
 Fiat 1352226080  
 Fiat 6001070756  
 Peugeot 3521.P1

**Application info**

Citroën Jumper III (04/06--)  
 Peugeot Boxer III (09/05--)

Fiat Ducato (250) (07/06--)

**Control arm**

11-16 050 0066

MCA0112

**Notes**

Control Arm  
 Front Axle Left  
 Lower  
 Steel  
 with rubber mount

Paired article number  
 Required quantity  
 replacement in pairs recommended

11-16 050 0065 | MCA0111

1

**References**

Citroën 3520.S0  
 Fiat 1352227080  
 Fiat 6001070757  
 Peugeot 16 109 347 80  
 Peugeot 3520.S1

Citroën 3520.S1  
 Fiat 1352228080  
 Fiat 6001070758  
 Peugeot 3520.S0

**Application info**

Citroën Jumper III (04/06--)  
 Peugeot Boxer III (09/05--)

Fiat Ducato (250) (07/06--)

**Control arm**

11-16 050 0067

MCA0113

**Notes**

Control Arm  
 Front Axle Right  
 Lower  
 Steel  
 with rubber mount

Cone Size [mm]  
 Paired article number  
 Required quantity  
 replacement in pairs recommended

19

11-16 050 0068 | MCA0114

1

**References**

Citroën 3521.N9  
 Fiat 1401239480  
 Lancia 1401239480  
 Peugeot 3521.N9  
 Toyota SU001-A0993

Citroën 3521.S0  
 Fiat 1497407080  
 Peugeot 16 109 405 80  
 Peugeot 3521.S0

**Application info**

Citroën C8 (06/02--)

Fiat Scudo II (270) (01/07--)

Lancia Phedra (09/02-11/10)

Peugeot Expert II (01/07--)

Toyota Proace II (02/16--)

Citroën Jumpy II (01/07--)

Fiat Ulysse II (179) (08/02-06/11)

Peugeot 807 (06/02--)

Toyota Proace I (06/13-03/16)

**Control arm****11-16 050 0068****MCA0114****Notes**

Control Arm  
 Front Axle Left  
 Lower  
 Steel  
 with rubber mount

Cone Size [mm]

19

Paired article number

11-16 050 0067 | MCA0113

Required quantity

1

replacement in pairs recommended

**References**

Citroën 3520.R8

Fiat 1401239580

Lancia 1401239580

Peugeot 3520.R8

Toyota SU001-A0992

Citroën 3520.V8

Fiat 1497408080

Peugeot 16 109 406 80

Peugeot 3520.V8

**Application info**

Citroën C8 (06/02--)

Fiat Scudo II (270) (01/07--)

Lancia Phedra (09/02-11/10)

Peugeot Expert II (01/07--)

Toyota Proace II (02/16--)





Citroën Jumpy II (01/07--)



Fiat Ulysse II (179) (08/02-06/11)



Peugeot 807 (06/02--)

Toyota Proace I (06/13-03/16)



Control arm		11-16 050 0071/HD	MCA0809HD
<b>Notes</b>	Carbon Neutral Control Arm Front Axle Right Steel with rubber mount		
Paired article number Replace in pairs only Required quantity reinforced version	11-16 050 0072/HD   MCA0810HD 1		
<b>References</b>			
Citroën 16 431 891 80		Citroën 3521.R3	
DS 16 431 891 80		DS 3521.R3	
Peugeot 16 43 189 180		Peugeot 3521.R3	
<b>Application info</b>			
Citroën C4 II / DS4 (02/09--)		DS DS 4 I (07/15-12/18)	
Peugeot 3008 I (05/09-12/17)		Peugeot 308 I (09/07--)	
Peugeot 5008 I (06/09-03/17)			
Control arm		11-16 050 0072/HD	MCA0810HD
<b>Notes</b>	Carbon Neutral Control Arm Front Axle Left Steel with rubber mount		
Paired article number Replace in pairs only Required quantity reinforced version	11-16 050 0071/HD   MCA0809HD 1		
<b>References</b>			
Citroën 16 431 887 80		Citroën 3520.V2	
DS 16 431 887 80		DS 3520.V2	
Peugeot 16 43 188 780		Peugeot 3520.V2	
<b>Application info</b>			
Citroën C4 II / DS4 (02/09--)		DS DS 4 I (07/15-12/18)	
Peugeot 3008 I (05/09-12/17)		Peugeot 308 I (09/07--)	
Peugeot 5008 I (06/09-03/17)			

Control arm		11-16 050 0073	MCA0115
<p><b>Notes</b></p> <p>Control Arm Front Axle Left Lower Steel with rubber mount</p> <p>Paired article number Required quantity replacement in pairs recommended</p>			
<p><b>References</b></p> <p>Citroën 3520.S9 Citroën 3520.W2 Citroën 96 639 808 80</p>		<p>Citroën 3520.W1 Citroën 96 639 806 80</p>	
<p><b>Application info</b></p> <p>Citroën C5 III (RD_, TD_) (02/08--)</p>		<p>Citroën C6 (09/05-12/12)</p>	
Control arm		11-16 050 0074	MCA0116
<p><b>Notes</b></p> <p>Control Arm Front Axle Right Lower Steel with rubber mount</p> <p>Paired article number Required quantity replacement in pairs recommended</p>			
<p><b>References</b></p> <p>Citroën 3521.Q0 Citroën 3521.S5 Citroën 96 639 809 80</p>		<p>Citroën 3521.S4 Citroën 96 639 807 80</p>	
<p><b>Application info</b></p> <p>Citroën C5 III (RD_, TD_) (02/08--)</p>		<p>Citroën C6 (09/05-12/12)</p>	

Control arm		11-16 050 0075	MCA0117
<p><b>Notes</b></p> <p>Control Arm Front Axle Left Lower Steel with rubber mount</p> <p>Paired article number Required quantity replacement in pairs recommended</p>			
<p><b>References</b></p> <p>Citroën 3520.X6</p>		<p>Citroën 96 662 440 80</p>	
<p><b>Application info</b></p> <p>Citroën C5 III (RD_, TD_) (02/08--)</p>			
Control arm		11-16 050 0076	MCA0118
<p><b>Notes</b></p> <p>Control Arm Front Axle Right Lower Steel with rubber mount</p> <p>Paired article number Required quantity replacement in pairs recommended</p>			
<p><b>References</b></p> <p>Citroën 3521.T7</p>		<p>Citroën 96 662 439 80</p>	
<p><b>Application info</b></p> <p>Citroën C5 III (RD_, TD_) (02/08--)</p>			

## Control arm

11-16 050 0079/HD

MCA0784HD

## Notes

Carbon Neutral  
Control Arm  
Front Axle Left  
Lower  
Sheet Steel  
with ball joint  
with rubber mount

Paired article number 11-16 050 0080/HD | MCA0785HD  
Replace in pairs only  
Required quantity 1  
reinforced version



## References

Citroën 3520.W7  
Citroën 3520.X1  
Citroën 98 032 865 80  
DS 3520 X1  
DS 3520.W7  
Peugeot 98 032 865 80

Citroën 3520.W8  
Citroën 3520.Y1  
DS 3520 W8  
DS 3520 Y1  
DS 98 032 865 80  
Peugeot 98 13 612 780

## Application info

Citroën C3 II (09/09--)  
Citroën C4 Cactus (09/14--)  
DS DS 3 (04/15-07/19)  
Peugeot 208 I (03/12--)

Citroën C3 III (07/16--)  
Citroën DS3 (11/09-12/16)  
Peugeot 2008 I (03/13--)

## Control arm

11-16 050 0080/HD

MCA0785HD

## Notes

Carbon Neutral  
Control Arm  
Front Axle Right  
Lower  
Sheet Steel  
with ball joint  
with rubber mount

Paired article number 11-16 050 0079/HD | MCA0784HD  
Replace in pairs only  
Required quantity 1  
reinforced version



**References**

Citroën 3521.S9

Citroën 3521.T3

Citroën 98 032 864 80

DS 3521 T3

DS 3521.S9

Peugeot 98 032 864 80

Citroën 3521.T0

Citroën 3521.V2

DS 3521 T0

DS 3521 V2

DS 98 032 864 80

Peugeot 98 13 612 580

**Application info**

Citroën C3 II (09/09--)

Citroën C4 Cactus (09/14--)

DS DS 3 (04/15-07/19)

Peugeot 208 I (03/12--)

Citroën C3 III (07/16--)

Citroën DS3 (11/09-12/16)

Peugeot 2008 I (03/13--)

**Control arm****11-16 050 0081/HD****MCA0786HD****Notes**

Carbon Neutral  
Control Arm  
Front Axle Left  
Lower  
Sheet Steel  
with ball joint  
with rubber mount

Paired article number

11-16 050 0082/HD | MCA0787HD

Replace in pairs only

Required quantity

1

reinforced version

**References**

Citroën 16 139 915 80

Citroën 3520.T5

Citroën 3520.T7

Citroën 3520.T9

Peugeot 3520.T3

Citroën 3520.T2

Citroën 3520.T6

Citroën 3520.T8

Peugeot 3520.T2

**Application info**

Citroën C2 / C3 I / Pluriel (02/02--)

Peugeot 1007 (04/05--)

**Control arm** 11-16 050 0082/HD MCA0787HD

**Notes**

Carbon Neutral  
Control Arm  
Front Axle Right  
Lower  
Sheet Steel  
with ball joint  
with rubber mount

Paired article number 11-16 050 0081/HD | MCA0786HD  
Replace in pairs only  
Required quantity 1  
reinforced version



**References**

- |                       |                 |
|-----------------------|-----------------|
| Citroën 16 139 914 80 | Citroën 3521 Q3 |
| Citroën 3521 Q6       | Citroën 3521 Q7 |
| Citroën 3521 Q8       | Citroën 3521 Q9 |
| Citroën 3521 R0       | Peugeot 3521 Q3 |
| Peugeot 3521 Q4       |                 |

**Application info**

Citroën C2 / C3 I / Pluriel (02/02--)  
Peugeot 1007 (04/05--)

**Control arm** 11-16 050 0083 MCA0121

**Notes**

Control Arm  
Front Axle Right  
Lower  
Steel  
with rubber mount

Cone Size [mm] 17  
Paired article number 11-16 050 0084 | MCA0122  
Required quantity 1  
replacement in pairs recommended



**References**

Citroën 16 075 107 80

Citroën 3521.S7

Fiat 1356 061 080

Fiat 1363 096 080

Fiat 6001070762

Lancia 1359 399 080

Lancia 1368 629 080

Peugeot 16 07 510 780

Peugeot 3521.S7

Citroën 3521.P6

Citroën 3521.T2

Fiat 1359 399 080

Fiat 1368 629 080

Lancia 1356 061 080

Lancia 1363 096 080

Lancia 6001070762

Peugeot 3521.P6

Peugeot 3521.T2

**Application info**

Citroën C8 (06/02--)

Lancia Phedra (09/02-11/10)

Fiat Ulysse II (179) (08/02-06/11)

Peugeot 807 (06/02--)

**Control arm****11-16 050 0084****MCA0122****Notes**

Control Arm  
Front Axle Left  
Lower  
Steel  
with rubber mount

Cone Size [mm]

17

Paired article number

11-16 050 0083 | MCA0121

Required quantity

1

replacement in pairs recommended

**References**

Citroën 16 075 106 80

Citroën 3520.W4

Fiat 1356 060 080

Fiat 1363 095 080

Fiat 6001070761

Lancia 1359 398 080

Lancia 1368 628 080

Peugeot 16 07 510 680

Peugeot 3520.W4

Citroën 3520.S5

Citroën 3520.X0

Fiat 1359 398 080

Fiat 1368 628 080

Lancia 1356 060 080

Lancia 1363 095 080

Lancia 6001070761

Peugeot 3520.S5

Peugeot 3520.X0

**Application info**

Citroën C8 (06/02--)

Lancia Phedra (09/02-11/10)

Fiat Ulysse II (179) (08/02-06/11)

Peugeot 807 (06/02--)

Control arm		11-16 050 0085/HD	MCA1120HD
<p><b>Notes</b></p> <p>Carbon Neutral Control Arm Front Axle Right Lower Steel with ball joint with rubber mount</p> <p>Paired article number Replace in pairs only Required quantity reinforced version</p>	<p>11-16 050 0086/HD   MCA1121HD</p> <p>1</p>		

**References**

Peugeot 3521.V1

Peugeot 96 66 681 380

**Application info**

Peugeot 508 I (11/10--)

Control arm		11-16 050 0086/HD	MCA1121HD
<p><b>Notes</b></p> <p>Carbon Neutral Control Arm Front Axle Left Lower Steel with ball joint with rubber mount</p> <p>Paired article number Replace in pairs only Required quantity reinforced version</p>	<p>11-16 050 0085/HD   MCA1120HD</p> <p>1</p>		

**References**

Peugeot 3520.Y0

Peugeot 96 66 681 480

**Application info**

Peugeot 508 I (11/10--)



**Control arm****11-16 050 0102****MCA1174****Notes**

Control Arm  
Front Axle Right  
Sheet Steel  
with ball joint

Paired article number 11-16 050 0103 | MCA1175  
Required quantity 1  
replacement in pairs recommended

**References**

Citroën 96 750 288 80  
Citroën 98 194 182 80  
GENERAL MOTORS 3647088  
Opel 36 47 086  
Peugeot 96 75 028 880

Citroën 98 194 180 80  
GENERAL MOTORS 3647086  
GENERAL MOTORS 9819418280  
Opel 36 47 088

**Application info**

Citroën C Elyse (11/12--)  
Opel Crossland X (03/17--)  
Vauxhall Crossland X (03/17--)

Citroën C3 AIRCROSS II (06/17--)  
Peugeot 301 (11/12--)

**Control arm****11-16 050 0103****MCA1175****Notes**

Control Arm  
Front Axle Left  
Sheet Steel  
with ball joint

Paired article number 11-16 050 0102 | MCA1174  
Required quantity 1  
replacement in pairs recommended

**References**

Citroën 96 750 318 80  
Citroën 98 194 181 80  
GENERAL MOTORS 3647089  
Opel 36 47 087  
Peugeot 96 75 031 880

Citroën 98 194 179 80  
GENERAL MOTORS 3647087  
GENERAL MOTORS 9819418180  
Opel 36 47 089

**Application info**

Citroën C Elyse (11/12--)  
 Opel Crossland X (03/17--)  
 Vauxhall Crossland X (03/17--)

Citroën C3 AIRCROSS II (06/17--)  
 Peugeot 301 (11/12--)  
 Vauxhall Grandland X (75) (06/17--)

**Control arm**

11-16 050 0106

MCA1222

**Notes**

Aluminium  
 Control Arm  
 Rear Axle Right  
 Upper  
 outer

Paired article number 11-16 050 0107 | MCA1223  
 Required quantity 1  
 replacement in pairs recommended



**References**

Citroën 5175.CP

Peugeot 5175.CH

**Application info**

Citroën C5 III (RD\_, TD\_) (02/08--)  
 Peugeot 407 (02/04--)

Citroën C6 (09/05-12/12)  
 Peugeot 508 I (11/10--)

**Control arm**

11-16 050 0107

MCA1223

**Notes**

Aluminium  
 Control Arm  
 Rear Axle Left  
 Upper  
 outer

Paired article number 11-16 050 0106 | MCA1222  
 Required quantity 1  
 replacement in pairs recommended

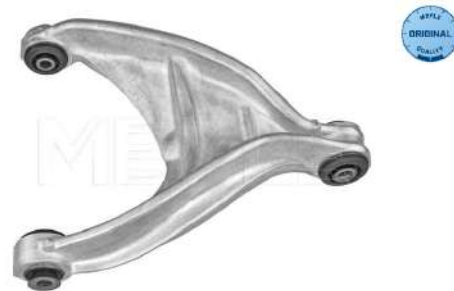

**References**



Citroën 5175.CN

Peugeot 5175.CG

**Application info**

Citroën C5 III (RD\_, TD\_) (02/08--)  
 Peugeot 407 (02/04--)

Citroën C6 (09/05-12/12)  
 Peugeot 508 I (11/10--)

Control arm		11-16 050 0110/HD	MCA1234HD
<p><b>Notes</b></p> <p>Carbon Neutral Control Arm Front Axle Left Lower Steel with rubber mount</p> <p>Paired article number Replace in pairs only Required quantity reinforced version</p>			
<p><b>References</b></p> <p>Citroën 98 056 074 80 Peugeot 98 056 074 80</p>		<p>DS 98 056 074 80</p>	
<p><b>Application info</b></p> <p>Citroën C4 II / DS4 (02/09--) Peugeot 5008 I (06/09-03/17)</p>		<p>DS DS 4 I (07/15-12/18)</p>	
Control arm		11-16 050 0111/HD	MCA1235HD
<p><b>Notes</b></p> <p>Carbon Neutral Control Arm Front Axle Right Steel with rubber mount</p> <p>Paired article number Replace in pairs only Required quantity reinforced version</p>			
<p><b>References</b></p> <p>Citroën 16 431 893 80 DS 16 431 893 80 Peugeot 16 43 189 380</p>		<p>Citroën 98 056 073 80 DS 98 056 073 80 Peugeot 98 056 073 80</p>	
<p><b>Application info</b></p> <p>Citroën C4 II / DS4 (02/09--) Peugeot 5008 I (06/09-03/17)</p>		<p>DS DS 4 I (07/15-12/18)</p>	

**Control arm****11-16 050 0114****MCA1288****Notes**

Control Arm  
Front Axle Right  
Steel  
for left-hand drive vehicles  
for right-hand drive vehicles  
with ball joint

Manufacturer Exclusion

CITROËN

Paired article number

11-16 050 0115 | MCA1289

Required quantity

1

replacement in pairs recommended

**References**

Opel 98 463 292 80

Peugeot 96 78 311 280

Peugeot 98 07 914 180

Peugeot 98 20 381 580

Peugeot 98 46 329 280

**Application info**

Opel Astra L (10/21--)

Peugeot 308 I (09/07--)

Peugeot 308 II (09/13--)

Peugeot 308 III (07/21--)

Vauxhall Astra Mk VIII (10/21--)

**Control arm****11-16 050 0115****MCA1289****Notes**

Control Arm  
Front Axle Left  
Steel  
for left-hand drive vehicles  
for right-hand drive vehicles  
with ball joint

Manufacturer Exclusion

CITROËN

Paired article number

11-16 050 0114 | MCA1288

Required quantity

1

replacement in pairs recommended

**References**

Opel 98 463 297 80

Peugeot 96 78 311 380

Peugeot 98 07 914 280

Peugeot 98 20 381 680

Peugeot 98 46 329 780

**Application info**

Opel Astra L (10/21--)  
 Peugeot 308 II (09/13--)  
 Vauxhall Astra Mk VIII (10/21--)

Peugeot 308 I (09/07--)  
 Peugeot 308 III (07/21--)

**Control arm****11-16 050 3198****MCA0125****Notes**

Control Arm  
 Front Axle Left  
 Lower  
 Steel  
 with rubber mount

Length [mm]

304

Paired article number

11-16 050 3199 | MCA0126

Required quantity

1

replacement in pairs recommended

**References**

Citroën 3520.51

Citroën 91 504 358

Citroën 91 516 335

Citroën 91 516 336

Peugeot 3520.48

Peugeot 3520.49

Peugeot 3520.50

Peugeot 3520.51

**Application info**

Citroën C15 / Visa (09/78-10/06)

Peugeot 205 (02/83-12/00)

**Control arm****11-16 050 3199****MCA0126****Notes**

Control Arm  
 Front Axle Right  
 Lower  
 Steel  
 with rubber mount

Length [mm]

304

Paired article number

11-16 050 3198 | MCA0125

Required quantity

1

replacement in pairs recommended

**References**

Citroën 3521.34

Citroën 91 516 334

Citroën 91 516 337

Peugeot 3521.31

Peugeot 3521.33

Peugeot 3521.34

**Application info**

Citroën C15 / Visa (09/78-10/06)

Peugeot 205 (02/83-12/00)

**Control arm**

11-16 050 6979

MCA0127

**Notes**

Control Arm  
Front Axle Right  
Lower  
Steel  
with rubber mount

Paired article number

11-16 050 6980 | MCA0128

Required quantity

1

replacement in pairs recommended

**References**

Citroën 3520.79

Citroën 95 658 979

Peugeot 3520.79

**Application info**

Citroën AX (07/86-12/98)

Citroën Saxo (02/96-04/04)

Peugeot 106 (08/91-05/05)

**Control arm**

11-16 050 6980

MCA0128

**Notes**

Control Arm  
Front Axle Left  
Lower  
Steel  
with rubber mount

Paired article number

11-16 050 6979 | MCA0127

Required quantity

1

replacement in pairs recommended

**References**

Citroën 3520.78

Citroën 95 658 978



Peugeot 3520.78

**Application info**

Citroën AX (07/86-12/98)

Citroën Saxo (02/96-04/04)

Peugeot 106 (08/91-05/05)

Control arm		116 050 0000/HD	MCA0131HD
<b>Notes</b>	<p>Aluminium Carbon Neutral Control Arm Front Front Axle Left Front Axle Right Lower with accessories with rubber mount</p> <p>Length [mm] 364</p> <p>Replace in pairs only</p> <p>Required quantity 2</p> <p>reinforced version</p>		
<b>References</b>	<p>Audi 8E0 407 151 E                      Audi 8E0 407 151 K</p> <p>Audi 8E0 407 151 L                      Audi 8E0 407 151 M</p> <p>Audi 8E0 407 151 N                      Audi 8E0 407 151 R</p> <p>Audi (FAW) 8E0 407 151 M              Audi (FAW) 8E0 407 151 R</p> <p>Seat 8E0 407 151 R</p>		
<b>Application info</b>	<p>Audi A4 Cabriolet (8H_) (01/02-12/09)</p> <p>Audi A4 III (8E_) (11/04-06/08)</p>	<p>Audi A4 II (8E_) (02/00-12/05)</p> <p>Seat Exeo (3R) (12/08-05/13)</p>	
Control arm		116 050 0002/HD	MCA0132HD
<b>Notes</b>	<p>Carbon Neutral Control Arm Front Axle Left Sheet Steel with rubber mount</p> <p>Article number of recommended accessori 100 654 0008</p> <p>Paired article number 116 050 0003/HD   MCA0133HD</p> <p>Replace in pairs only</p> <p>Required quantity 1</p> <p>reinforced version</p>		

**References**

Audi 1K0 407 151 AA	Audi 1K0 407 151 AB
Audi 1K0 407 151 AE	Audi 1K0 407 151 AH
Audi 1K0 407 151 BC	Audi 1K0 407 151 BD
Audi 1K0 407 151 N	Audi 1K0 407 151 P
Seat 1K0 407 151 AA	Seat 1K0 407 151 AB
Seat 1K0 407 151 AE	Seat 1K0 407 151 AH
Seat 1K0 407 151 BC	Seat 1K0 407 151 BD
Seat 1K0 407 151 N	Seat 1K0 407 151 P
Skoda 1K0 407 151 AA	Skoda 1K0 407 151 AB
Skoda 1K0 407 151 AE	Skoda 1K0 407 151 AH
Skoda 1K0 407 151 BC	Skoda 1K0 407 151 N
Skoda 1K0 407 151 P	Skoda (SVW) 1K0 407 151 BC
Volkswagen 1K0 407 151 AA	Volkswagen 1K0 407 151 AB
Volkswagen 1K0 407 151 AE	Volkswagen 1K0 407 151 AH
Volkswagen 1K0 407 151 BC	Volkswagen 1K0 407 151 BD
Volkswagen 1K0 407 151 N	Volkswagen 1K0 407 151 P
Volkswagen 2K0 407 151 B	Volkswagen (FAW) 1K0 407 151 AA

**Application info**

Audi A3 II (8P_) (05/03-12/15)	Seat Leon II / Toledo III / Altea (1P_ ,5P_) (03/04--)
Skoda Octavia II (1Z_) (02/04-06/13)	Skoda Superb II (3T) (03/08-05/15)
Skoda Yeti (5L) (05/09-12/17)	Vauxhall Movano Mk I (10/98-12/10)
Volkswagen Caddy III (2KA, 2KB) (03/04-05/15)	Volkswagen Eos (03/06-08/15)
Volkswagen Golf V (1K1, 1K5, 5M1) (10/03-08/14)	Volkswagen Golf VI (5K1, 517, AJ5) (10/08-05/16)
Volkswagen Jetta III (1K2) (09/04-12/13)	Volkswagen Scirocco III (137) (05/08-11/17)
Volkswagen Touran I (1T1/2/3) (02/03-05/15)	

**Control arm****116 050 0003/HD****MCA0133HD****Notes**

Carbon Neutral  
Control Arm  
Front Axle Right  
Sheet Steel  
with rubber mount  
without ball joint

Article number of recommended accessories	100 654 0008
Paired article number	116 050 0002/HD   MCA0132HD
Replace in pairs only	
Required quantity	1
reinforced version	





**References**

Audi 1K0 407 152 AA	Audi 1K0 407 152 AB
Audi 1K0 407 152 AE	Audi 1K0 407 152 AH
Audi 1K0 407 152 BC	Audi 1K0 407 152 BD
Audi 1K0 407 152 N	Audi 1K0 407 152 P
Seat 1K0 407 152 AA	Seat 1K0 407 152 AB
Seat 1K0 407 152 AE	Seat 1K0 407 152 AH
Seat 1K0 407 152 BC	Seat 1K0 407 152 BD
Seat 1K0 407 152 N	Seat 1K0 407 152 P
Skoda 1K0 407 152 AA	Skoda 1K0 407 152 AB
Skoda 1K0 407 152 AE	Skoda 1K0 407 152 AH
Skoda 1K0 407 152 BC	Skoda 1K0 407 152 N
Skoda 1K0 407 152 P	Skoda (SVW) 1K0 407 152 BC
Volkswagen 1K0 407 152 AA	Volkswagen 1K0 407 152 AB
Volkswagen 1K0 407 152 AE	Volkswagen 1K0 407 152 AH
Volkswagen 1K0 407 152 BC	Volkswagen 1K0 407 152 BD
Volkswagen 1K0 407 152 N	Volkswagen 1K0 407 152 P
Volkswagen 2K0 407 152 B	Volkswagen (FAW) 1K0 407 152 AA

**Application info**

Audi A3 II (8P_) (05/03-12/15)	Seat Leon II / Toledo III / Altea (1P_ ,5P_) (03/04--)
Skoda Octavia II (1Z_) (02/04-06/13)	Skoda Superb II (3T) (03/08-05/15)
Skoda Yeti (5L) (05/09-12/17)	Vauxhall Movano Mk I (10/98-12/10)
Volkswagen Caddy III (2KA, 2KB) (03/04-05/15)	Volkswagen Eos (03/06-08/15)
Volkswagen Golf V (1K1, 1K5, 5M1) (10/03-08/14)	Volkswagen Golf VI (5K1, 517, AJ5) (10/08-05/16)
Volkswagen Jetta III (1K2) (09/04-12/13)	Volkswagen Scirocco III (137) (05/08-11/17)
Volkswagen Touran I (1T1/2/3) (02/03-05/15)	

**Control arm****116 050 0005****MCA0134****Notes**

Control Arm  
Front Axle Left  
Lower  
Sheet Steel  
with ball joint  
with rubber mount

Paired article number 116 050 0006 | MCA0135  
Required quantity 1

replacement in pairs recommended



**References**

Skoda 007 304 447  
 Skoda 6U0 407 151 A  
 Volkswagen 6U0 407 151  
 Volkswagen 6U0 407 151 B

Skoda 6U0 407 151  
 Skoda 6U0 407 151 B  
 Volkswagen 6U0 407 151 A

**Application info**

Skoda Felicia (10/94-04/02)

Volkswagen Caddy II (9K9, 9K9B, 9U7) (11/95-06/09)

**Control arm**

116 050 0006

MCA0135

**Notes**

Control Arm  
 Front Axle Right  
 Lower  
 Sheet Steel  
 with ball joint  
 with rubber mount  
 Paired article number 116 050 0005 | MCA0134  
 Required quantity 1

Paired article number  
 Required quantity  
 replacement in pairs recommended



**References**

Skoda 007 304 448  
 Skoda 6U0 407 152 A  
 Volkswagen 6U0 407 152  
 Volkswagen 6U0 407 152 B

Skoda 6U0 407 152  
 Skoda 6U0 407 152 B  
 Volkswagen 6U0 407 152 A

**Application info**

Skoda Felicia (10/94-04/02)

Volkswagen Caddy II (9K9, 9K9B, 9U7) (11/95-06/09)

**Control arm**

116 050 0007/HD

MCA0136HD

**Notes**

Carbon Neutral  
 Control Arm  
 Front Axle Right  
 Lower  
 Steel  
 with rubber mount  
 Paired article number 116 050 0008/HD | MCA0137HD  
 Required quantity 1

Paired article number  
 Replace in pairs only  
 Required quantity  
 reinforced version



**References**

Ford 1 012 632

Seat 7M0 407 152 B

Ford 95VW-3078-AC

Volkswagen 7M0 407 152 B

**Application info**

Ford Galaxy I (03/95-05/06)

Volkswagen Sharan (7M) (05/95-03/10)

Seat Alhambra I (7V8, 7V9) (03/96-03/10)

**Control arm****116 050 0008/HD****MCA0137HD****Notes**

Carbon Neutral

Control Arm

Front Axle Left

Lower

Steel

with rubber mount

Paired article number

116 050 0007/HD | MCA0136HD

Replace in pairs only

Required quantity

1

reinforced version

**References**

Ford 1 007 602

Seat 7M0 407 151 B

Ford 95VW-3079-AC

Volkswagen 7M0 407 151 B

**Application info**

Ford Galaxy I (03/95-05/06)

Volkswagen Sharan (7M) (05/95-03/10)

Seat Alhambra I (7V8, 7V9) (03/96-03/10)

**Control arm****116 050 0009/HD****MCA0138HD****Notes**

Carbon Neutral

Control Arm

Front Axle Left

Sheet Steel

with ball joint

Length [mm]

347

Paired article number

116 050 0010/HD | MCA0139HD

Replace in pairs only

Required quantity

1

Thread Size

M12x1,5

Width [mm]

277

reinforced version



**References**

Audi 1J0 407 151 A  
 Audi 1J0 407 151 C  
 Skoda 1J0 407 151 C  
 Volkswagen 1J0 407 151 B  
 Volkswagen (FAW) 1J0 407 151 C

Audi 1J0 407 151 B  
 Seat 1J0 407 151 C  
 Volkswagen 1J0 407 151 A  
 Volkswagen 1J0 407 151 C  
 Volkswagen (SVW) 1JD 407 151 A

**Application info**

Audi A3 I (8L\_) (09/96-09/06)  
 Skoda Octavia I (1U\_) (09/96-12/10)  
 Volkswagen Bora V (Mex) (01/07--)  
 Volkswagen Golf VI (5K1, 517, AJ5) (10/08-05/16)  
 Volkswagen New Beetle (1Y7, 9C1, 1C1) (01/98-12/11)

Seat Leon I / Toledo II (1M\_) (10/98-06/06)  
 Volkswagen Bora (1J2, 1J6) (10/98-12/13)  
 Volkswagen Golf IV (1J1, 1J5) (08/97-06/14)  
 Volkswagen Jetta City (09/06-12/09)

**Control arm**

116 050 0010/HD

MCA0139HD

**Notes**

Carbon Neutral  
 Control Arm  
 Front Axle Right  
 Sheet Steel  
 with ball joint  
 Length [mm] 347  
 Paired article number 116 050 0009/HD | MCA0138HD  
 Replace in pairs only  
 Required quantity 1  
 Thread Size M12x1,5  
 Width [mm] 277  
 reinforced version



**References**

Audi 1J0 407 151 A  
 Audi 1J0 407 151 C  
 Skoda 1J0 407 151 C  
 Volkswagen 1J0 407 151 B  
 Volkswagen (FAW) 1J0 407 151 C

Audi 1J0 407 151 B  
 Seat 1J0 407 151 C  
 Volkswagen 1J0 407 151 A  
 Volkswagen 1J0 407 151 C  
 Volkswagen (SVW) 1JD 407 151 A

**Application info**

Audi A3 I (8L\_) (09/96-09/06)  
 Skoda Octavia I (1U\_) (09/96-12/10)  
 Volkswagen Bora V (Mex) (01/07--)  
 Volkswagen Golf VI (5K1, 517, AJ5) (10/08-05/16)  
 Volkswagen New Beetle (1Y7, 9C1, 1C1) (01/98-12/11)

Seat Leon I / Toledo II (1M\_) (10/98-06/06)  
 Volkswagen Bora (1J2, 1J6) (10/98-12/13)  
 Volkswagen Golf IV (1J1, 1J5) (08/97-06/14)  
 Volkswagen Jetta City (09/06-12/09)

**Control arm** 116 050 0012 MCA0140

**Notes**

Control Arm  
 Front Axle Left  
 Front Axle Right  
 Lower  
 Sheet Steel  
 with rubber mount

Article number of recommended accessories 100 654 0021  
 Required quantity 2  
 replacement in pairs recommended



**References**

Seat 6X0 407 151 A Volkswagen 6N0 407 151 A  
 Volkswagen 6X0 407 151 A

**Application info**

Seat Arosa (6H) (05/97-06/04) Volkswagen Lupo (09/98-07/05)  
 Volkswagen Polo (6N\_) (09/94-10/01)

**Control arm** 116 050 0015/HD MCA0142HD

**Notes**

Aluminium  
 Carbon Neutral  
 Control Arm  
 Front Axle Left  
 Rear  
 Upper  
 with accessories  
 with rubber mount

Length [mm] 256  
 Paired article number 116 050 0016/HD | MCA0143HD  
 Replace in pairs only  
 Required quantity 1  
 reinforced version



**References**

Audi 4E0 407 509 B

Audi 4E0 407 509 F

Audi 4E0 407 509 H

Audi (FAW) 4E0 407 509 B

Audi (FAW) 4E0 407 509 G

Audi (FAW) L4E0 407 509 B

Volkswagen 4E0 407 509 E

Audi 4E0 407 509 E

Audi 4E0 407 509 G

Audi 4E0 407 509 K

Audi (FAW) 4E0 407 509 E

Audi (FAW) 4E0 407 509 K

Volkswagen 4E0 407 509 B

Volkswagen 4E0 407 509 G

**Application info**

Audi A6 III (4F2, 4FH, 4F5) (04/04-08/11)

Volkswagen Phaeton (3D) (04/02-03/16)

Audi A8 II (4E\_) (10/02-12/10)

**Control arm****116 050 0016/HD****MCA0143HD****Notes**

Aluminium  
Carbon Neutral  
Control Arm  
Front Axle Right  
Rear  
Upper  
with accessories  
with rubber mount

Length [mm]

257

Paired article number

116 050 0015/HD | MCA0142HD

Replace in pairs only

Required quantity

1

reinforced version

**References**

Audi 4E0 407 510 B

Audi 4E0 407 510 F

Audi 4E0 407 510 H

Audi (FAW) 4E0 407 510 B

Audi (FAW) 4E0 407 510 G

Audi (FAW) L4E0 407 510 B

Volkswagen 4E0 407 510 E

Audi 4E0 407 510 E

Audi 4E0 407 510 G

Audi 4E0 407 510 K

Audi (FAW) 4E0 407 510 E

Audi (FAW) 4E0 407 510 K

Volkswagen 4E0 407 510 B





Volkswagen 4E0 407 510 G

**Application info**

Audi A6 III (4F2, 4FH, 4F5) (04/04-08/11)

Volkswagen Phaeton (3D) (04/02-03/16)

Audi A8 II (4E\_) (10/02-12/10)

Control arm		116 050 0017	MCA0144
<p><b>Notes</b></p> <p>Aluminium Control Arm Front Axle Left Front Axle Right Upper with ball joint with rubber mount</p> <p>Required quantity replacement in pairs recommended</p>		 	
<p><b>References</b></p> <p>Audi 7L0 407 021 Audi 7L0 407 021 B Porsche 955 341 027 01 Volkswagen 7L0 407 021 Volkswagen 7L0 407 021 B</p>		<p>Audi 7L0 407 021 A Porsche 955 341 027 00 Porsche 955 341 027 02 Volkswagen 7L0 407 021 A</p>	
<p><b>Application info</b></p> <p>Audi Q7 I (4L_) (03/06-01/16) Volkswagen Touareg I (7LA, 7L6 ,7L7 ) (10/02-01/13)</p>		<p>Porsche Cayenne I (955) (09/02-12/10)</p>	
Control arm		116 050 0017/S	MCA0983
<p><b>Notes</b></p> <p>Aluminium Control Arm Front Axle Left Front Axle Right Upper with accessories with ball joint with rubber mount</p> <p>Required quantity replacement in pairs recommended</p>		 	
<p><b>References</b></p> <p>Audi 7L0 407 021 Audi 7L0 407 021 B Porsche 955 341 027 01 Volkswagen 7L0 407 021 Volkswagen 7L0 407 021 B</p>		<p>Audi 7L0 407 021 A Porsche 955 341 027 00 Porsche 955 341 027 02 Volkswagen 7L0 407 021 A</p>	

**Application info**

Audi Q7 I (4L\_) (03/06-01/16)

Porsche Cayenne I (955) (09/02-12/10)

Volkswagen Touareg I (7LA, 7L6 ,7L7 ) (10/02-01/13)

**Control arm**

116 050 0018

MCA0145

**Notes**

Control Arm  
Front Axle Left  
Sheet Steel  
with ball joint  
with rubber mount

Article number of recommended accessories 100 654 0020  
Paired article number 116 050 0019 | MCA0146  
Required quantity 1  
replacement in pairs recommended



**References**

Seat 6Q0 407 151 E

Seat 6Q0 407 151 L

Skoda 6Q0 407 151 E

Skoda 6Q0 407 151 L

Volkswagen 6Q0 407 151 D

Volkswagen 6Q0 407 151 E

Volkswagen 6Q0 407 151 L

Volkswagen (SVW) 6Q0 407 151 L

**Application info**

Seat Ibiza III / Cordoba II (6L\_) (02/02-11/09)

Skoda Fabia I (6Y\_) (08/99-03/08)

Skoda Fabia II (54\_) (12/06-12/14)

Skoda Roomster (03/06-05/15)

Volkswagen Fox/Lupo (Z51) (08/03--)

Volkswagen Polo (9N\_) (10/01--)

**Control arm**

116 050 0019

MCA0146

**Notes**

Control Arm  
Front Axle Right  
Sheet Steel  
with ball joint  
with rubber mount

Article number of recommended accessories 100 654 0020  
Paired article number 116 050 0018 | MCA0145  
Required quantity 1  
replacement in pairs recommended





**References**

Seat 6Q0 407 151 E

Skoda 6Q0 407 151 E

Volkswagen 6Q0 407 151 D

Volkswagen 6Q0 407 151 L

Seat 6Q0 407 151 L

Skoda 6Q0 407 151 L

Volkswagen 6Q0 407 151 E

Volkswagen (SVW) 6Q0 407 151 L

**Application info**

Seat Ibiza III / Cordoba II (6L\_) (02/02-11/09)

Skoda Fabia II (54\_) (12/06-12/14)

Volkswagen Fox/Lupo (Z51) (08/03--)

Skoda Fabia I (6Y\_) (08/99-03/08)

Skoda Roomster (03/06-05/15)

Volkswagen Polo (9N\_) (10/01--)

**Control arm****116 050 0028****MCA0149****Notes**

Control Arm  
 Front Axle Left  
 Front Axle Right  
 Lower  
 Sheet Steel  
 with rubber mount  
 2

Required quantity

replacement in pairs recommended

**References**

Seat 6Q0 407 151 E

Skoda 6Q0 407 151 E

Volkswagen 6Q0 407 151 D

Volkswagen 6Q0 407 151 L

Seat 6Q0 407 151 L

Skoda 6Q0 407 151 L

Volkswagen 6Q0 407 151 E

Volkswagen (SVW) 6Q0 407 151 L

**Application info**

Seat Ibiza III / Cordoba II (6L\_) (02/02-11/09)

Skoda Fabia II (54\_) (12/06-12/14)

Volkswagen Fox/Lupo (Z51) (08/03--)

Skoda Fabia I (6Y\_) (08/99-03/08)

Skoda Roomster (03/06-05/15)

Volkswagen Polo (9N\_) (10/01--)

**Control arm set** **014 035 0017** **MCX0031**

**Notes**

Rear Axle Left  
Rear Axle Right  
for trailing arm  
with accessories

Full Set

Required quantity

1



**References**

Mercedes-Benz 210 350 21 53  
Mercedes-Benz 210 350 34 06  
Mercedes-Benz A 210 350 21 53  
Mercedes-Benz A 210 350 34 06

Mercedes-Benz 210 350 33 06  
Mercedes-Benz 210 350 38 06  
Mercedes-Benz A 210 350 33 06  
Mercedes-Benz A 210 350 38 06

**Application info**

Mercedes-Benz BM 124 (12/84-12/93)  
Mercedes-Benz BM 129 (SL) (03/89-09/04)  
Mercedes-Benz BM 201 (190) (10/82-08/93)  
Mercedes-Benz BM 208 (CLK) (06/97-12/03)

Mercedes-Benz BM 124 (E-Class) (02/93-03/98)  
Mercedes-Benz BM 170 (SLK) (04/96-04/04)  
Mercedes-Benz BM 202 (C-Class) (03/93-03/01)  
Mercedes-Benz BM 210 (E-Class) (06/95-08/03)

**Control arm set** **016 050 0090/HD** **MCK0040HD**

**Notes**

Carbon Neutral  
Front Axle Left  
Front Axle Right

Full Set

Required quantity  
reinforced version

1



**References**

Mercedes-Benz 203 320 04 89  
 Mercedes-Benz 203 320 28 89  
 Mercedes-Benz 203 330 01 11  
 Mercedes-Benz 203 330 16 11  
 Mercedes-Benz 203 330 19 11  
 Mercedes-Benz 203 330 33 11  
 Mercedes-Benz 203 330 35 11  
 Mercedes-Benz 203 330 39 11  
 Mercedes-Benz 204 330 19 11  
 Mercedes-Benz 204 330 33 11  
 Mercedes-Benz 204 330 43 11  
 Mercedes-Benz A 203 320 04 89  
 Mercedes-Benz A 203 320 28 89  
 Mercedes-Benz A 203 330 01 11  
 Mercedes-Benz A 203 330 16 11  
 Mercedes-Benz A 203 330 19 11  
 Mercedes-Benz A 203 330 33 11  
 Mercedes-Benz A 203 330 35 11  
 Mercedes-Benz A 203 330 39 11  
 Mercedes-Benz A 204 330 19 11  
 Mercedes-Benz A 204 330 33 11  
 Mercedes-Benz A 204 330 43 11

Mercedes-Benz 203 320 25 89  
 Mercedes-Benz 203 320 38 89  
 Mercedes-Benz 203 330 02 11  
 Mercedes-Benz 203 330 17 11  
 Mercedes-Benz 203 330 20 11  
 Mercedes-Benz 203 330 34 11  
 Mercedes-Benz 203 330 36 11  
 Mercedes-Benz 203 330 40 11  
 Mercedes-Benz 204 330 20 11  
 Mercedes-Benz 204 330 34 11  
 Mercedes-Benz 204 330 44 11  
 Mercedes-Benz A 203 320 25 89  
 Mercedes-Benz A 203 320 38 89  
 Mercedes-Benz A 203 330 02 11  
 Mercedes-Benz A 203 330 17 11  
 Mercedes-Benz A 203 330 20 11  
 Mercedes-Benz A 203 330 34 11  
 Mercedes-Benz A 203 330 36 11  
 Mercedes-Benz A 203 330 40 11  
 Mercedes-Benz A 204 330 20 11  
 Mercedes-Benz A 204 330 34 11  
 Mercedes-Benz A 204 330 44 11

**Application info**

Mercedes-Benz BM 203 (C-Class) (05/00-06/11)

Mercedes-Benz BM 209 (CLK) (05/02-03/10)

**Control arm set**

016 050 0091/HD

MCK0041HD

**Notes**

Carbon Neutral  
 Front Axle Left  
 Front Axle Right

Full Set  
 Required quantity  
 reinforced version

1



**References**

Mercedes-Benz 203 330 01 11  
 Mercedes-Benz 203 330 16 11  
 Mercedes-Benz 203 330 19 11  
 Mercedes-Benz 203 330 33 11  
 Mercedes-Benz 203 330 35 11  
 Mercedes-Benz 203 330 39 11  
 Mercedes-Benz 204 330 19 11  
 Mercedes-Benz 204 330 33 11  
 Mercedes-Benz 204 330 43 11  
 Mercedes-Benz A 203 330 01 11  
 Mercedes-Benz A 203 330 16 11  
 Mercedes-Benz A 203 330 19 11  
 Mercedes-Benz A 203 330 33 11  
 Mercedes-Benz A 203 330 35 11  
 Mercedes-Benz A 203 330 39 11  
 Mercedes-Benz A 204 330 19 11  
 Mercedes-Benz A 204 330 33 11  
 Mercedes-Benz A 204 330 43 11

Mercedes-Benz 203 330 02 11  
 Mercedes-Benz 203 330 17 11  
 Mercedes-Benz 203 330 20 11  
 Mercedes-Benz 203 330 34 11  
 Mercedes-Benz 203 330 36 11  
 Mercedes-Benz 203 330 40 11  
 Mercedes-Benz 204 330 20 11  
 Mercedes-Benz 204 330 34 11  
 Mercedes-Benz 204 330 44 11  
 Mercedes-Benz A 203 330 02 11  
 Mercedes-Benz A 203 330 17 11  
 Mercedes-Benz A 203 330 20 11  
 Mercedes-Benz A 203 330 34 11  
 Mercedes-Benz A 203 330 36 11  
 Mercedes-Benz A 203 330 40 11  
 Mercedes-Benz A 204 330 20 11  
 Mercedes-Benz A 204 330 34 11  
 Mercedes-Benz A 204 330 44 11

**Application info**

Mercedes-Benz BM 203 (C-Class) (05/00-06/11)

Mercedes-Benz BM 209 (CLK) (05/02-03/10)

**Control arm set**

016 050 0092/HD

MCK0043HD

**Notes**

Carbon Neutral  
 Front Axle Left  
 Front Axle Right

Full Set

Required quantity  
 reinforced version

1



**References**

- |                                    |                                      |
|------------------------------------|--------------------------------------|
| Mercedes-Benz 203 330 01 11        | Mercedes-Benz 203 330 02 11          |
| Mercedes-Benz 203 330 16 11        | Mercedes-Benz 203 330 17 11          |
| Mercedes-Benz 203 330 35 11        | Mercedes-Benz 203 330 36 11          |
| Mercedes-Benz 203 330 39 11        | Mercedes-Benz 203 330 40 11          |
| Mercedes-Benz 204 330 31 11        | Mercedes-Benz 204 330 32 11          |
| Mercedes-Benz 204 330 33 11        | Mercedes-Benz 204 330 34 11          |
| Mercedes-Benz 204 330 43 11        | Mercedes-Benz 204 330 44 11          |
| Mercedes-Benz 204 330 67 11        | Mercedes-Benz 204 330 68 11          |
| Mercedes-Benz 204 330 87 11        | Mercedes-Benz 204 330 88 11          |
| Mercedes-Benz A 203 330 01 11      | Mercedes-Benz A 203 330 02 11        |
| Mercedes-Benz A 203 330 16 11      | Mercedes-Benz A 203 330 17 11        |
| Mercedes-Benz A 203 330 35 11      | Mercedes-Benz A 203 330 36 11        |
| Mercedes-Benz A 203 330 39 11      | Mercedes-Benz A 203 330 40 11        |
| Mercedes-Benz A 204 330 31 11      | Mercedes-Benz A 204 330 32 11        |
| Mercedes-Benz A 204 330 33 11      | Mercedes-Benz A 204 330 34 11        |
| Mercedes-Benz A 204 330 43 11      | Mercedes-Benz A 204 330 44 11        |
| Mercedes-Benz A 204 330 67 11      | Mercedes-Benz A 204 330 68 11        |
| Mercedes-Benz A 204 330 87 11      | Mercedes-Benz A 204 330 88 11        |
| Mercedes-Benz (BBDC) 204 330 67 11 | Mercedes-Benz (BBDC) A 204 330 67 11 |

**Application info**

- |  |  |
|--|--|
| Mercedes-Benz BM 204 (C-Class) (01/07--) | Mercedes-Benz BM 207 (E-Class) (01/09-12/16) |
|--|--|

**Control arm set**

016 050 0093/HD

MCK0044HD

**Notes**

Carbon Neutral  
Front Axle Left  
Front Axle Right

Full Set  
Required quantity  
reinforced version

1



**References**

- |                                    |                                      |
|------------------------------------|--------------------------------------|
| Mercedes-Benz 212 330 27 11        | Mercedes-Benz 212 330 28 11          |
| Mercedes-Benz 212 330 29 11        | Mercedes-Benz 212 330 30 11          |
| Mercedes-Benz 212 330 39 00        | Mercedes-Benz 212 330 40 00          |
| Mercedes-Benz A 212 330 27 11      | Mercedes-Benz A 212 330 28 11        |
| Mercedes-Benz A 212 330 29 11      | Mercedes-Benz A 212 330 30 11        |
| Mercedes-Benz A 212 330 39 00      | Mercedes-Benz A 212 330 40 00        |
| Mercedes-Benz (BBDC) 212 330 39 00 | Mercedes-Benz (BBDC) A 212 330 39 00 |

**Application info**

Mercedes-Benz BM 212 (E-Class) (01/09-12/16)

**Control arm set**

016 050 0094/HD

MCK0042HD

**Notes**

Carbon Neutral  
Front Axle Left  
Front Axle Right

Full Set

Required quantity  
reinforced version

1



**References**

- Mercedes-Benz 203 330 01 11
- Mercedes-Benz 203 330 16 11
- Mercedes-Benz 203 330 19 11
- Mercedes-Benz 203 330 33 11
- Mercedes-Benz 203 330 35 11
- Mercedes-Benz 203 330 39 11
- Mercedes-Benz 204 330 19 11
- Mercedes-Benz 204 330 33 11
- Mercedes-Benz 204 330 43 11
- Mercedes-Benz 204 330 87 11
- Mercedes-Benz A 203 330 01 11
- Mercedes-Benz A 203 330 16 11
- Mercedes-Benz A 203 330 19 11
- Mercedes-Benz A 203 330 33 11
- Mercedes-Benz A 203 330 35 11
- Mercedes-Benz A 203 330 39 11
- Mercedes-Benz A 204 330 19 11
- Mercedes-Benz A 204 330 33 11
- Mercedes-Benz A 204 330 43 11
- Mercedes-Benz A 204 330 87 11

- Mercedes-Benz 203 330 02 11
- Mercedes-Benz 203 330 17 11
- Mercedes-Benz 203 330 20 11
- Mercedes-Benz 203 330 34 11
- Mercedes-Benz 203 330 36 11
- Mercedes-Benz 203 330 40 11
- Mercedes-Benz 204 330 20 11
- Mercedes-Benz 204 330 34 11
- Mercedes-Benz 204 330 44 11
- Mercedes-Benz 204 330 88 11
- Mercedes-Benz A 203 330 02 11
- Mercedes-Benz A 203 330 17 11
- Mercedes-Benz A 203 330 20 11
- Mercedes-Benz A 203 330 34 11
- Mercedes-Benz A 203 330 36 11
- Mercedes-Benz A 203 330 40 11
- Mercedes-Benz A 204 330 20 11
- Mercedes-Benz A 204 330 34 11
- Mercedes-Benz A 204 330 44 11
- Mercedes-Benz A 204 330 88 11

**Application info**

Mercedes-Benz BM 171 (SLK) (03/04-12/11)

**Control arm set**

016 050 0225/HD

MCK0061HD

**Notes**

Carbon Neutral  
 Front Axle Left  
 Front Axle Right  
 for vehicles without Airmatic DC

Full Set  
 Required quantity  
 reinforced version

1



**References**

Mercedes-Benz 205 330 13 05  
 Mercedes-Benz 205 330 43 03  
 Mercedes-Benz 205 330 55 01  
 Mercedes-Benz 205 330 59 01  
 Mercedes-Benz 205 330 62 01  
 Mercedes-Benz 205 330 66 10  
 Mercedes-Benz A 205 330 14 05  
 Mercedes-Benz A 205 330 44 03  
 Mercedes-Benz A 205 330 56 01  
 Mercedes-Benz A 205 330 61 01  
 Mercedes-Benz A 205 330 65 10

Mercedes-Benz 205 330 14 05  
 Mercedes-Benz 205 330 44 03  
 Mercedes-Benz 205 330 56 01  
 Mercedes-Benz 205 330 61 01  
 Mercedes-Benz 205 330 65 10  
 Mercedes-Benz A 205 330 13 05  
 Mercedes-Benz A 205 330 43 03  
 Mercedes-Benz A 205 330 55 01  
 Mercedes-Benz A 205 330 59 01  
 Mercedes-Benz A 205 330 62 01  
 Mercedes-Benz A 205 330 66 10

**Application info**

Mercedes-Benz BM 205 (C-Class) (12/13--)  
 Mercedes-Benz BM 238 (E-Class) (06/17--)

Mercedes-Benz BM 213 (E-Class) (01/16--)  
 Mercedes-Benz BM 257 (CLS-Class) (12/17--)

**Control arm set**

016 050 0231/HD

MCK0062HD

**Notes**

Front Axle Left  
 Front Axle Right  
 for vehicles with Airmatic DC

Full Set  
 Required quantity  
 reinforced version

1



**References**

Mercedes-Benz 205 330 13 05	Mercedes-Benz 205 330 14 05
Mercedes-Benz 205 330 21 07	Mercedes-Benz 205 330 22 07
Mercedes-Benz 205 330 43 03	Mercedes-Benz 205 330 44 03
Mercedes-Benz 205 330 55 01	Mercedes-Benz 205 330 56 01
Mercedes-Benz 205 330 63 01	Mercedes-Benz 205 330 64 01
Mercedes-Benz A 205 330 13 05	Mercedes-Benz A 205 330 14 05
Mercedes-Benz A 205 330 21 07	Mercedes-Benz A 205 330 22 07
Mercedes-Benz A 205 330 43 03	Mercedes-Benz A 205 330 44 03
Mercedes-Benz A 205 330 55 01	Mercedes-Benz A 205 330 56 01
Mercedes-Benz A 205 330 63 01	Mercedes-Benz A 205 330 64 01

**Application info**

Mercedes-Benz BM 205 (C-Class) (12/13--)	Mercedes-Benz BM 213 (E-Class) (01/16--)
Mercedes-Benz BM 238 (E-Class) (06/17--)	Mercedes-Benz BM 257 (CLS-Class) (12/17--)

**Control arm set**

116 050 0022/HD

MCK0004HD

**Notes**

Aluminium  
Carbon Neutral  
Front Axle Left  
Front Axle Right  
Lower  
with accessories

Required quantity  
Slim Set  
reinforced version

1



**References**

Audi 3B0 498 798 A	Skoda 3B0 498 798 A
Volkswagen 3B0 498 798 A	

**Application info**

Audi A4 I (8D_) (11/94-12/02)	Audi A6 II (4B, C5) (01/97-12/05)
Audi A8 I (4D_) (03/94-12/05)	Skoda Superb I (3U) (12/01-03/08)
Volkswagen Passat (3B_) (08/96-12/05)	



**Mount, axle rod****014 035 0085****MAM0005****Notes**

Rear Axle Left  
 Rear Axle Right  
 Upper  
 inner

Height [mm] 38  
 Inner Diameter [mm] 12  
 Outer Diameter [mm] 38  
 Required quantity 2  
 replacement in pairs recommended

**References**

Mercedes-Benz 204 353 00 43  
 Mercedes-Benz 230 352 15 65  
 Mercedes-Benz A 205 352 05 08  
 Mercedes-Benz (BBDC) 205 352 05 08  
 Mercedes-Benz (BBDC) A 205 352 05 08

Mercedes-Benz 205 352 05 08  
 Mercedes-Benz A 204 353 00 43  
 Mercedes-Benz A 230 352 15 65  
 Mercedes-Benz (BBDC) 230 352 15 65  
 Mercedes-Benz (BBDC) A 230 352 15 65

**Application info**

Mercedes-Benz BM 204 (C-Class) (01/07--)  
 Mercedes-Benz BM 205 (C-Class) (12/13--)  
 Mercedes-Benz BM 211 (E-Class) (03/02-07/09)  
 Mercedes-Benz BM 213 (E-Class) (01/16--)  
 Mercedes-Benz BM 219 (CLS) (10/04-02/11)  
 Mercedes-Benz BM 238 (E-Class) (06/17--)  
 Mercedes-Benz BM 257 (CLS-Class) (12/17--)

Mercedes-Benz BM 204 (GLK-Class) (06/08-12/15)  
 Mercedes-Benz BM 207 (E-Class) (01/09-12/16)  
 Mercedes-Benz BM 212 (E-Class) (01/09-12/16)  
 Mercedes-Benz BM 218 (CLS) (01/11-12/17)  
 Mercedes-Benz BM 230 (SL) (10/01-01/12)  
 Mercedes-Benz BM 253 (GLC) (06/15--)  
 Mercedes-Benz BM 293 (EQC) (05/19--)

**Mount, axle rod****014 710 0013****MAM0008****Notes**

Front  
 Rear Axle Left  
 Rear Axle Right  
 Upper  
 inner

Height [mm] 73  
 Inner Diameter [mm] 12  
 Outer Diameter [mm] 40  
 Required quantity 2  
 replacement in pairs recommended



**References**

Mercedes-Benz 204 350 05 53	Mercedes-Benz 204 350 06 53
Mercedes-Benz 205 350 65 03	Mercedes-Benz 205 350 66 03
Mercedes-Benz A 204 350 05 53	Mercedes-Benz A 204 350 06 53
Mercedes-Benz A 205 350 65 03	Mercedes-Benz A 205 350 66 03
Mercedes-Benz (BBDC) 205 350 65 03	Mercedes-Benz (BBDC) A 205 350 65 03

**Application info**

Mercedes-Benz BM 204 (C-Class) (01/07--)	Mercedes-Benz BM 204 (GLK-Class) (06/08-12/15)
Mercedes-Benz BM 205 (C-Class) (12/13--)	Mercedes-Benz BM 207 (E-Class) (01/09-12/16)
Mercedes-Benz BM 212 (E-Class) (01/09-12/16)	Mercedes-Benz BM 213 (E-Class) (01/16--)
Mercedes-Benz BM 218 (CLS) (01/11-12/17)	Mercedes-Benz BM 238 (E-Class) (06/17--)
Mercedes-Benz BM 253 (GLC) (06/15--)	Mercedes-Benz BM 257 (CLS-Class) (12/17--)
Mercedes-Benz BM 293 (EQC) (05/19--)	

**Mount, axle rod**

014 710 0014

MAM0009

**Notes**

Front  
Rear Axle Left  
Rear Axle Right  
Upper  
outer

Height [mm]	37
Inner Diameter [mm]	12
Outer Diameter [mm]	40
Required quantity	2
replacement in pairs recommended	



**References**

Mercedes-Benz 204 350 05 53	Mercedes-Benz 204 350 06 53
Mercedes-Benz 205 350 65 03	Mercedes-Benz 205 350 66 03
Mercedes-Benz A 204 350 05 53	Mercedes-Benz A 204 350 06 53
Mercedes-Benz A 205 350 65 03	Mercedes-Benz A 205 350 66 03
Mercedes-Benz (BBDC) 205 350 66 03	Mercedes-Benz (BBDC) A 205 350 66 03

**Application info**

Mercedes-Benz BM 204 (C-Class) (01/07--)	Mercedes-Benz BM 204 (GLK-Class) (06/08-12/15)
Mercedes-Benz BM 205 (C-Class) (12/13--)	Mercedes-Benz BM 207 (E-Class) (01/09-12/16)
Mercedes-Benz BM 212 (E-Class) (01/09-12/16)	Mercedes-Benz BM 213 (E-Class) (01/16--)
Mercedes-Benz BM 218 (CLS) (01/11-12/17)	Mercedes-Benz BM 238 (E-Class) (06/17--)
Mercedes-Benz BM 253 (GLC) (06/15--)	Mercedes-Benz BM 257 (CLS-Class) (12/17--)
Mercedes-Benz BM 293 (EQC) (05/19--)	

**Mount, axle rod**

014 710 0015

MAM0010

**Notes**

Rear Axle Left  
Rear Axle Right  
Upper  
inner

Height [mm] 41  
Inner Diameter [mm] 12  
Outer Diameter [mm] 44  
Required quantity 2  
replacement in pairs recommended



**References**

Mercedes-Benz 204 350 21 06	Mercedes-Benz 204 350 22 06
Mercedes-Benz A 204 350 21 06	Mercedes-Benz A 204 350 22 06
Mercedes-Benz (BBDC) 204 350 21 06	Mercedes-Benz (BBDC) 204 350 22 06
Mercedes-Benz (BBDC) A 204 350 21 06	Mercedes-Benz (BBDC) A 204 350 22 06

**Application info**

Mercedes-Benz BM 204 (C-Class) (01/07--)	Mercedes-Benz BM 204 (GLK-Class) (06/08-12/15)
Mercedes-Benz BM 205 (C-Class) (12/13--)	Mercedes-Benz BM 207 (E-Class) (01/09-12/16)
Mercedes-Benz BM 212 (E-Class) (01/09-12/16)	Mercedes-Benz BM 213 (E-Class) (01/16--)
Mercedes-Benz BM 218 (CLS) (01/11-12/17)	Mercedes-Benz BM 238 (E-Class) (06/17--)
Mercedes-Benz BM 253 (GLC) (06/15--)	Mercedes-Benz BM 257 (CLS-Class) (12/17--)
Mercedes-Benz BM 293 (EQC) (05/19--)	

**Mount, axle rod**

014 710 0016

MAM0011

**Notes**

Rear Axle Left  
Rear Axle Right  
Upper  
outer

Height [mm] 38  
Inner Diameter [mm] 12  
Outer Diameter [mm] 44  
Required quantity 2  
replacement in pairs recommended



**References**

Mercedes-Benz 204 350 21 06	Mercedes-Benz 204 350 22 06
Mercedes-Benz A 204 350 21 06	Mercedes-Benz A 204 350 22 06
Mercedes-Benz (BBDC) 204 350 21 06	Mercedes-Benz (BBDC) A 204 350 21 06

**Application info**

Mercedes-Benz BM 204 (C-Class) (01/07--)  
 Mercedes-Benz BM 205 (C-Class) (12/13--)  
 Mercedes-Benz BM 212 (E-Class) (01/09-12/16)  
 Mercedes-Benz BM 218 (CLS) (01/11-12/17)  
 Mercedes-Benz BM 253 (GLC) (06/15--)  
 Mercedes-Benz BM 293 (EQC) (05/19--)

Mercedes-Benz BM 204 (GLK-Class) (06/08-12/15)  
 Mercedes-Benz BM 207 (E-Class) (01/09-12/16)  
 Mercedes-Benz BM 213 (E-Class) (01/16--)  
 Mercedes-Benz BM 238 (E-Class) (06/17--)  
 Mercedes-Benz BM 257 (CLS-Class) (12/17--)

**Mount, axle rod**

100 710 0016

MAM0019

**Notes**

Front  
 Rear Axle Left  
 Rear Axle Right  
 outer

Height [mm] 40  
 Inner Diameter [mm] 14  
 Outer Diameter [mm] 44  
 Required quantity 2  
 replacement in pairs recommended



**References**

Audi 7L0 505 323 A

Volkswagen 7L0 505 323 A

**Application info**

Audi Q7 I (4L\_) (03/06-01/16)  
 Porsche Cayenne II (92A) (06/10--)  
 Volkswagen Touareg II (7P5) (01/10-12/18)

Porsche Cayenne I (955) (09/02-12/10)  
 Volkswagen Touareg I (7LA, 7L6, 7L7) (10/02-01/13)

**Mount, axle rod**

100 710 0017

MAM0020

**Notes**

Front  
 Rear Axle Left  
 Rear Axle Right  
 inner

Height [mm] 40  
 Inner Diameter [mm] 12  
 Outer Diameter [mm] 44  
 Required quantity 2  
 replacement in pairs recommended



**References**

Audi 7L0 505 323 A

Volkswagen 7L0 505 323 A

**Application info**

Audi Q7 I (4L\_) (03/06-01/16)

Porsche Cayenne II (92A) (06/10--)

Volkswagen Touareg II (7P5 ) (01/10-12/18)

Porsche Cayenne I (955) (09/02-12/10)

Volkswagen Touareg I (7LA, 7L6 ,7L7 ) (10/02-01/13)

**Mount, control arm**

014 033 0090

MCB0012

**Notes**

Front Axle Left  
 Front Axle Right  
 Lower  
 Rear  
 inner  
 without holder

Height [mm]

45

Inner Diameter [mm]

24

Outer Diameter [mm]

70

Required quantity

2

replacement in pairs recommended



**References**

Mercedes-Benz 211 333 11 14

Mercedes-Benz (BBDC) 211 333 11 14

Mercedes-Benz A 211 333 11 14

Mercedes-Benz (BBDC) A 211 333 11 14

**Application info**

Mercedes-Benz BM 171 (SLK) (03/04-12/11)

Mercedes-Benz BM 203 (C-Class) (05/00-06/11)

Mercedes-Benz BM 211 (E-Class) (03/02-07/09)

Mercedes-Benz BM 231 (SL) (01/12--)

Mercedes-Benz BM 172 (SLC) (01/16--)

Mercedes-Benz BM 204 (C-Class) (01/07--)

Mercedes-Benz BM 219 (CLS) (10/04-02/11)

**Mount, control arm**

014 033 0115/HD

MCB0016HD

**Notes**

Carbon Neutral  
 Front  
 Front Axle Left  
 Front Axle Right  
 Lower  
 without holder

Height [mm]

80

Inner Diameter [mm]

18

Outer Diameter [mm]

70

Replace in pairs only

Required quantity

2

reinforced version



**References**

Mercedes-Benz 203 333 02 14	Mercedes-Benz 203 333 10 14
Mercedes-Benz 204 333 10 14	Mercedes-Benz 211 333 29 14
Mercedes-Benz A 203 333 02 14	Mercedes-Benz A 203 333 10 14
Mercedes-Benz A 204 333 10 14	Mercedes-Benz A 211 333 29 14
Mercedes-Benz (BBDC) 203 333 10 14	Mercedes-Benz (BBDC) A 203 333 10 14

**Application info**

Mercedes-Benz BM 171 (SLK) (03/04-12/11)	Mercedes-Benz BM 172 (SLC) (01/16--)
Mercedes-Benz BM 172 (SLK) (01/11--)	Mercedes-Benz BM 203 (C-Class) (05/00-06/11)
Mercedes-Benz BM 204 (C-Class) (01/07--)	Mercedes-Benz BM 204 (GLK-Class) (06/08-12/15)
Mercedes-Benz BM 207 (E-Class) (01/09-12/16)	Mercedes-Benz BM 209 (CLK) (05/02-03/10)
Mercedes-Benz BM 211 (E-Class) (03/02-07/09)	Mercedes-Benz BM 212 (E-Class) (01/09-12/16)
Mercedes-Benz BM 219 (CLS) (10/04-02/11)	Mercedes-Benz BM 230 (SL) (10/01-01/12)
Mercedes-Benz BM 231 (SL) (01/12--)	

**Mount, control arm****014 033 0149****MCB0017****Notes**

Front Axle Left  
 Front Axle Right  
 Lower  
 Rear  
 without holder

Height [mm]	80
Inner Diameter [mm]	24
Outer Diameter [mm]	70
Required quantity	2
replacement in pairs recommended	

**References**

Mercedes-Benz 203 333 03 14	Mercedes-Benz 203 333 09 14
Mercedes-Benz A 203 333 03 14	Mercedes-Benz A 203 333 09 14

**Application info**

Mercedes-Benz BM 171 (SLK) (03/04-12/11)	Mercedes-Benz BM 203 (C-Class) (05/00-06/11)
Mercedes-Benz BM 209 (CLK) (05/02-03/10)	

**Mount, control arm**

014 033 0157

MCB0018

**Notes**

Front  
 Front Axle Left  
 Front Axle Right  
 Lower  
 without holder

Height [mm] 80  
 Inner Diameter [mm] 18  
 Outer Diameter [mm] 70  
 Required quantity 2  
 replacement in pairs recommended



**References**

Mercedes-Benz 211 333 10 14  
 Mercedes-Benz 211 333 28 14  
 Mercedes-Benz A 211 333 10 14  
 Mercedes-Benz A 211 333 28 14  
 Mercedes-Benz (BBDC) 211 333 29 14

Mercedes-Benz 211 333 25 14  
 Mercedes-Benz 211 333 29 14  
 Mercedes-Benz A 211 333 25 14  
 Mercedes-Benz A 211 333 29 14  
 Mercedes-Benz (BBDC) A 211 333 29 14

**Application info**

Mercedes-Benz BM 211 (E-Class) (03/02-07/09)  
 Mercedes-Benz BM 230 (SL) (10/01-01/12)

Mercedes-Benz BM 219 (CLS) (10/04-02/11)  
 Mercedes-Benz BM 231 (SL) (01/12--)

**Mount, control arm**

014 610 0007

MCB0028

**Notes**

Front Axle Left  
 Front Axle Right  
 Lower  
 Rear  
 inner  
 without holder

Height [mm] 80  
 Inner Diameter [mm] 23  
 Outer Diameter [mm] 61  
 Required quantity 2  
 replacement in pairs recommended



**References**

Mercedes-Benz 221 333 07 14

Mercedes-Benz A 221 333 07 14



**Application info**

Mercedes-Benz BM 216 (S-Class) (05/06-12/13)  
 Mercedes-Benz BM 221 (S-Class) (09/05-12/13)

Mercedes-Benz BM 220 (S-Class) (09/98-08/05)

**Mount, control arm**

014 610 0008

MCB0029

**Notes**

Front Axle Left  
 Front Axle Right  
 Rear  
 without holder

Height [mm] 42  
 Inner Diameter [mm] 20  
 Outer Diameter [mm] 46  
 Required quantity 2  
 replacement in pairs recommended



**References**

Mercedes-Benz 169 330 05 07  
 Mercedes-Benz 169 330 07 07  
 Mercedes-Benz 169 330 09 07  
 Mercedes-Benz A 169 330 05 07  
 Mercedes-Benz A 169 330 07 07  
 Mercedes-Benz A 169 330 09 07

Mercedes-Benz 169 330 06 07  
 Mercedes-Benz 169 330 08 07  
 Mercedes-Benz 169 330 10 07  
 Mercedes-Benz A 169 330 06 07  
 Mercedes-Benz A 169 330 08 07  
 Mercedes-Benz A 169 330 10 07

**Application info**

Mercedes-Benz BM 169 (A-Class) (09/04-06/12)

Mercedes-Benz BM 245 (B-Class) (03/05-11/11)

**Mount, control arm**

014 610 0012

MCB0031

**Notes**

Front  
 Front Axle Left  
 Front Axle Right  
 Lower  
 without holder

Height [mm] 80  
 Inner Diameter [mm] 23  
 Outer Diameter [mm] 70  
 Required quantity 2  
 replacement in pairs recommended



**References**

Mercedes-Benz 221 333 08 14

Mercedes-Benz A 221 333 08 14



**Application info**

Mercedes-Benz BM 216 (S-Class) (05/06-12/13)

Mercedes-Benz BM 221 (S-Class) (09/05-12/13)

Mercedes-Benz BM 220 (S-Class) (09/98-08/05)

**Mount, control arm****014 610 0013****MCB0032****Notes**

Front Axle Left  
 Front Axle Right  
 Lower  
 without holder

Height [mm]

80

Inner Diameter [mm]

15

Outer Diameter [mm]

53

Required quantity

2

replacement in pairs recommended

**References**

Mercedes-Benz 204 330 31 11

Mercedes-Benz 204 330 67 11

Mercedes-Benz A 204 330 31 11

Mercedes-Benz A 204 330 67 11

Mercedes-Benz (BBDC) 204 330 67 11

Mercedes-Benz (BBDC) A 204 330 67 11

Mercedes-Benz 204 330 32 11

Mercedes-Benz 204 330 68 11

Mercedes-Benz A 204 330 32 11

Mercedes-Benz A 204 330 68 11

Mercedes-Benz (BBDC) 204 330 68 11

Mercedes-Benz (BBDC) A 204 330 68 11

**Application info**

Mercedes-Benz BM 172 (SLC) (01/16--)

Mercedes-Benz BM 204 (C-Class) (01/07--)

Mercedes-Benz BM 172 (SLK) (01/11--)

Mercedes-Benz BM 207 (E-Class) (01/09-12/16)

**Mount, control arm****014 610 0014****MCB0033****Notes**

Front Axle Left  
 Front Axle Right  
 without holder

Height [mm]

42

Inner Diameter [mm]

10

Outer Diameter [mm]

46

Required quantity

2

replacement in pairs recommended



**References**

Mercedes-Benz 166 333 00 00  
 Mercedes-Benz 251 333 01 14  
 Mercedes-Benz A 166 333 07 14

Mercedes-Benz 166 333 07 14  
 Mercedes-Benz A 166 333 00 00  
 Mercedes-Benz A 251 333 01 14

**Application info**

Mercedes-Benz BM 164 (GL-Class) (09/06-12/12)  
 Mercedes-Benz BM 166 (GL) (07/12-12/15)  
 Mercedes-Benz BM 166 (GLS) (11/15-04/19)  
 Mercedes-Benz BM 251 (R-Class) (08/05-10/17)

Mercedes-Benz BM 164 (M-Class) (02/05-12/12)  
 Mercedes-Benz BM 166 (GLE) (03/15-10/19)  
 Mercedes-Benz BM 166 (M-Class) (06/11-12/15)

**Mount, control arm****014 610 0015****MCB0034****Notes**

Front Axle Left  
 Front Axle Right  
 Lower  
 inner  
 without holder

Height [mm] 37  
 Inner Diameter [mm] 12  
 Outer Diameter [mm] 39  
 Required quantity 2  
 replacement in pairs recommended

**References**

Smart 450 333 00 14  
 Smart A 450 333 00 14  
 Smart Q0014141V002000000

Smart 451 330 00 10  
 Smart A 451 330 00 10

**Application info**

Smart City Coupé / Cabrio (07/98-01/04)  
 Smart Fortwo I (01/04-02/07)  
 Smart Roadster (04/03-11/05)

Smart Crossblade (06/02-12/03)  
 Smart Fortwo II (01/07--)

**Mount, control arm****014 610 0016****MCB0035****Notes**

Front Axle Left  
 Front Axle Right  
 Lower  
 without holder

Height [mm] 80  
 Inner Diameter [mm] 14  
 Outer Diameter [mm] 53  
 Required quantity 2  
 replacement in pairs recommended

**References**

Mercedes-Benz 212 330 29 11  
 Mercedes-Benz 212 333 05 14  
 Mercedes-Benz A 212 330 30 11

Mercedes-Benz 212 330 30 11  
 Mercedes-Benz A 212 330 29 11  
 Mercedes-Benz A 212 333 05 14

**Application info**

Mercedes-Benz BM 212 (E-Class) (01/09-12/16)

Mercedes-Benz BM 218 (CLS) (01/11-12/17)

**Mount, control arm****014 610 0017/HD****MCB0036HD****Notes**

Carbon Neutral  
 Front Axle Left  
 Front Axle Right  
 Rear  
 without holder

Height [mm] 80  
 Inner Diameter [mm] 14  
 Outer Diameter [mm] 75  
 Replace in pairs only  
 Required quantity 2  
 reinforced version

**References**

Mercedes-Benz 212 333 00 14  
 Mercedes-Benz A 212 333 00 14  
 Mercedes-Benz (BBDC) 212 333 00 14  
 Mercedes-Benz (BBDC) A 212 333 00 14

Mercedes-Benz 212 333 03 14  
 Mercedes-Benz A 212 333 03 14  
 Mercedes-Benz (BBDC) 212 333 03 14  
 Mercedes-Benz (BBDC) A 212 333 03 14

**Application info**

Mercedes-Benz BM 212 (E-Class) (01/09-12/16)

Mercedes-Benz BM 218 (CLS) (01/11-12/17)

**Mount, control arm**

**014 610 0020**

**MCB0348**

**Notes**

Front  
Front Axle Left  
Front Axle Right  
Set  
without holder

Height [mm] 39  
Inner Diameter [mm] 20  
Outer Diameter [mm] 46  
Required quantity 2  
replacement in pairs recommended



**References**

Mercedes-Benz 246 330 17 07	Mercedes-Benz 246 330 18 07
Mercedes-Benz 246 330 47 00	Mercedes-Benz 246 330 48 00
Mercedes-Benz A 246 330 17 07	Mercedes-Benz A 246 330 18 07
Mercedes-Benz A 246 330 47 00	Mercedes-Benz A 246 330 48 00

**Application info**

Mercedes-Benz BM 117 (CLA) (01/13-03/19)	Mercedes-Benz BM 156 (GLA-Class) (12/13--)
Mercedes-Benz BM 176 (A-Class) (06/12-05/18)	Mercedes-Benz BM 246 (B-Class) (10/11-12/18)

**Mount, control arm**

**014 610 0021**

**MCM0001**

**Notes**

Front Axle Left  
Rear  
with holder

Height [mm] 62  
Inner Diameter [mm] 14  
Paired article number 014 610 0022 | MCM0002  
Required quantity 1  
replacement in pairs recommended

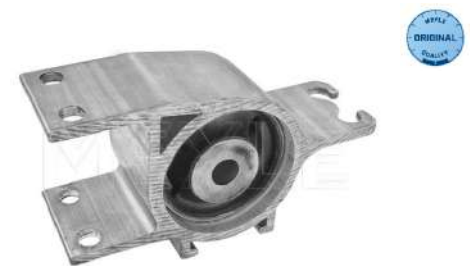

**References**

Mercedes-Benz 246 333 00 14	Mercedes-Benz 246 333 01 00
Mercedes-Benz 246 333 05 14	Mercedes-Benz A 246 333 00 14
Mercedes-Benz A 246 333 01 00	Mercedes-Benz A 246 333 05 14
Mercedes-Benz (BBDC) 246 333 05 14	Mercedes-Benz (BBDC) A 246 333 05 14

**Application info**

Mercedes-Benz BM 117 (CLA) (01/13-03/19)  
 Mercedes-Benz BM 176 (A-Class) (06/12-05/18)

Mercedes-Benz BM 156 (GLA-Class) (12/13--)  
 Mercedes-Benz BM 246 (B-Class) (10/11-12/18)

**Mount, control arm**

014 610 0022

MCM0002

**Notes**

Front Axle Right  
 Rear  
 with holder  
 Height [mm] 62  
 Inner Diameter [mm] 14  
 Paired article number 014 610 0021 | MCM0001  
 Required quantity 1  
 replacement in pairs recommended



**References**

Mercedes-Benz 246 333 02 00  
 Mercedes-Benz 246 333 06 14  
 Mercedes-Benz A 246 333 02 14  
 Mercedes-Benz (BBDC) 246 333 06 14

Mercedes-Benz 246 333 02 14  
 Mercedes-Benz A 246 333 02 00  
 Mercedes-Benz A 246 333 06 14  
 Mercedes-Benz (BBDC) A 246 333 06 14

**Application info**

Mercedes-Benz BM 117 (CLA) (01/13-03/19)  
 Mercedes-Benz BM 176 (A-Class) (06/12-05/18)

Mercedes-Benz BM 156 (GLA-Class) (12/13--)  
 Mercedes-Benz BM 246 (B-Class) (10/11-12/18)

**Mount, control arm**

014 610 0024

MCB0460

**Notes**

Front Axle Left  
 Front Axle Right  
 Hydro Mount  
 Rear  
 without holder  
 Height [mm] 67  
 Inner Diameter [mm] 16  
 Outer Diameter [mm] 70  
 Required quantity 2  
 replacement in pairs recommended



**References**

Mercedes-Benz 251 330 07 43  
 Mercedes-Benz 251 333 08 43  
 Mercedes-Benz A 251 333 08 14

Mercedes-Benz 251 333 08 14  
 Mercedes-Benz A 251 330 07 43  
 Mercedes-Benz A 251 333 08 43

**Application info**

Mercedes-Benz BM 251 (R-Class) (08/05-10/17)

**Mount, control arm**

014 610 0029

MCB0397

**Notes**

Front Axle Left  
 Front Axle Right  
 Lower  
 outer  
 without holder

Height [mm] 82  
 Inner Diameter [mm] 16.2  
 Outer Diameter [mm] 52.3  
 Required quantity 2  
 replacement in pairs recommended

**References**

Mercedes-Benz 164 333 03 14

Mercedes-Benz A 164 333 03 14

**Application info**

Mercedes-Benz BM 164 (GL-Class) (09/06-12/12)

Mercedes-Benz BM 164 (M-Class) (02/05-12/12)

Mercedes-Benz BM 251 (R-Class) (08/05-10/17)

**Mount, control arm**

014 610 0030

MCB0400

**Notes**

Front Axle Left  
 Front Axle Right  
 Lower  
 inner  
 without holder

Height [mm] 64.5  
 Inner Diameter [mm] 14.1  
 Outer Diameter [mm] 57.3  
 Required quantity 2  
 replacement in pairs recommended

**References**

Mercedes-Benz 164 333 04 14

Mercedes-Benz A 164 333 04 14

**Application info**

Mercedes-Benz BM 164 (GL-Class) (09/06-12/12)

Mercedes-Benz BM 164 (M-Class) (02/05-12/12)

Mercedes-Benz BM 251 (R-Class) (08/05-10/17)

**Mount, control arm** **014 610 0031** **MCM0148**

**Notes**

Front Axle Left  
with holder  
Height [mm] 55.5  
Inner Diameter [mm] 30  
Outer Diameter [mm] 70  
Paired article number 014 610 0032 | MCM0149  
Required quantity 1  
replacement in pairs recommended



**References**

- |                               |                               |
|-------------------------------|-------------------------------|
| Mercedes-Benz 164 330 17 07   | Mercedes-Benz 164 330 25 07   |
| Mercedes-Benz 164 330 29 07   | Mercedes-Benz 164 330 34 07   |
| Mercedes-Benz 164 333 12 14   | Mercedes-Benz A 164 330 17 07 |
| Mercedes-Benz A 164 330 25 07 | Mercedes-Benz A 164 330 29 07 |
| Mercedes-Benz A 164 330 34 07 | Mercedes-Benz A 164 333 12 14 |

**Application info**

Mercedes-Benz BM 164 (GL-Class) (09/06-12/12) Mercedes-Benz BM 164 (M-Class) (02/05-12/12)

**Mount, control arm** **014 610 0032** **MCM0149**

**Notes**

Front Axle Right  
with holder  
Height [mm] 55.5  
Inner Diameter [mm] 30  
Outer Diameter [mm] 70  
Paired article number 014 610 0031 | MCM0148  
Required quantity 1  
replacement in pairs recommended



**References**

- |                               |                               |
|-------------------------------|-------------------------------|
| Mercedes-Benz 164 330 18 07   | Mercedes-Benz 164 330 26 07   |
| Mercedes-Benz 164 330 30 07   | Mercedes-Benz 164 330 35 07   |
| Mercedes-Benz 164 333 12 14   | Mercedes-Benz A 164 330 18 07 |
| Mercedes-Benz A 164 330 26 07 | Mercedes-Benz A 164 330 30 07 |
| Mercedes-Benz A 164 330 35 07 | Mercedes-Benz A 164 333 12 14 |

**Application info**

Mercedes-Benz BM 164 (GL-Class) (09/06-12/12) Mercedes-Benz BM 164 (M-Class) (02/05-12/12)

**Mount, control arm**

014 610 0033

MCB0470

**Notes**

Front Axle Left  
 Front Axle Right  
 Lower  
 Rear  
 Rubber-Metal Mount  
 without holder

Height [mm] 60  
 Inner Diameter [mm] 14  
 Outer Diameter [mm] 70  
 Required quantity 2  
 replacement in pairs recommended



**References**

Mercedes-Benz 447 330 14 07  
 Mercedes-Benz 447 330 34 00  
 Mercedes-Benz 447 330 75 00  
 Mercedes-Benz 447 333 01 00  
 Mercedes-Benz 639 330 13 07  
 Mercedes-Benz 639 330 15 01  
 Mercedes-Benz A 447 330 15 07  
 Mercedes-Benz A 447 330 34 00  
 Mercedes-Benz A 447 330 75 00  
 Mercedes-Benz A 447 333 01 00  
 Mercedes-Benz A 639 330 12 07  
 Mercedes-Benz A 639 330 14 01

Mercedes-Benz 447 330 15 07  
 Mercedes-Benz 447 330 35 00  
 Mercedes-Benz 447 330 76 00  
 Mercedes-Benz 639 330 12 07  
 Mercedes-Benz 639 330 14 01  
 Mercedes-Benz A 447 330 14 07  
 Mercedes-Benz A 447 330 34 00  
 Mercedes-Benz A 447 330 75 00  
 Mercedes-Benz A 447 333 01 00  
 Mercedes-Benz A 639 330 13 07  
 Mercedes-Benz A 639 330 15 01

**Application info**

Mercedes-Benz BM 447 (V-Class) (03/14--)  
 Mercedes-Benz BM 639 (Vito / Viano) (08/03--)

Mercedes-Benz BM 447 (Vito) (10/14--)

**Mount, control arm**

014 610 0034

MCM0168

**Notes**

Front  
 Front Axle Right  
 Hydro Mount  
 Lower  
 with holder

Height [mm] 63  
 Inner Diameter [mm] 15  
 Paired article number 014 610 0035 | MCM0169  
 Required quantity 1  
 replacement in pairs recommended

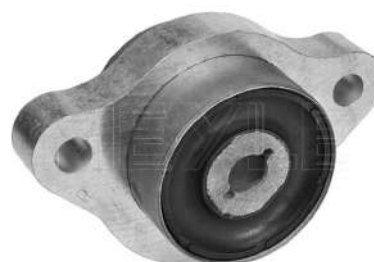



**References**

Mercedes-Benz 639 330 13 07  
 Mercedes-Benz A 639 330 13 07

Mercedes-Benz 639 330 15 01  
 Mercedes-Benz A 639 330 15 01

**Application info**

Mercedes-Benz BM 639 (Vito / Viano) (08/03--)

**Mount, control arm**

014 610 0035

MCM0169

**Notes**

Front  
 Front Axle Left  
 Hydro Mount  
 Lower  
 with holder  
 Height [mm] 63  
 Inner Diameter [mm] 15  
 Paired article number 014 610 0034 | MCM0168  
 Required quantity 1  
 replacement in pairs recommended



**References**

Mercedes-Benz 639 330 12 07  
 Mercedes-Benz A 639 330 12 07

Mercedes-Benz 639 330 14 01  
 Mercedes-Benz A 639 330 14 01

**Application info**

Mercedes-Benz BM 639 (Vito / Viano) (08/03--)

**Mount, control arm**

014 610 0037

MCM0171

**Notes**

Front Axle Left  
 Lower  
 with holder  
 Height [mm] 67  
 Inner Diameter [mm] 16  
 Paired article number 014 610 0038 | MCM0172  
 Required quantity 1  
 replacement in pairs recommended



**References**

Mercedes-Benz 251 330 07 43

Mercedes-Benz A 251 330 07 43

**Application info**

Mercedes-Benz BM 251 (R-Class) (08/05-10/17)

**Mount, control arm**

014 610 0038

MCM0172

**Notes**

Front Axle Right

Lower  
with holder

Height [mm]

67

Inner Diameter [mm]

16

Paired article number

014 610 0037 | MCM0171

Required quantity

1

replacement in pairs recommended

**References**

Mercedes-Benz 251 330 08 43

Mercedes-Benz A 251 330 08 43

**Application info**

Mercedes-Benz BM 251 (R-Class) (08/05-10/17)

**Mount, control arm**

014 610 0039

MCB0481

**Notes**

Front Axle Left

Front Axle Right

Lower  
inner  
without holder

Height [mm]

60

Inner Diameter [mm]

14

Outer Diameter [mm]

60

Quantity per axle

2

Required quantity

2

replacement in pairs recommended

**References**

Mercedes-Benz 205 333 38 00

Mercedes-Benz A 205 333 38 00

Mercedes-Benz (BBDC) 205 333 38 00

Mercedes-Benz (BBDC) A 205 333 38 00

**Application info**

Mercedes-Benz BM 205 (C-Class) (12/13--)

Mercedes-Benz BM 213 (E-Class) (01/16--)

Mercedes-Benz BM 238 (E-Class) (06/17--)

Mercedes-Benz BM 253 (GLC) (06/15--)

Mercedes-Benz BM 257 (CLS-Class) (12/17--)

**Mount, control arm** **014 610 0051** **MCB0561**

**Notes**

Front Axle Left  
 Front Axle Right  
 Molecular Bearing  
 outer  
 without holder

Height [mm] 48  
 Inner Diameter [mm] 14  
 Outer Diameter [mm] 43  
 Required quantity 2  
 replacement in pairs recommended



**References**

Mercedes-Benz 205 330 58 01 Mercedes-Benz 205 333 04 14  
 Mercedes-Benz A 205 330 58 01 Mercedes-Benz A 205 333 04 14  
 Mercedes-Benz (BBDC) 205 330 58 01 Mercedes-Benz (BBDC) A 205 330 58 01

**Application info**

Mercedes-Benz BM 205 (C-Class) (12/13--)  
 Mercedes-Benz BM 213 (E-Class) (01/16--)  
 Mercedes-Benz BM 253 (GLC) (06/15--)  
 Mercedes-Benz BM 293 (EQC) (05/19--)  
 Mercedes-Benz BM 207 (E-Class) (01/09-12/16)  
 Mercedes-Benz BM 238 (E-Class) (06/17--)  
 Mercedes-Benz BM 257 (CLS-Class) (12/17--)

**Mount, control arm** **014 610 0055** **MCB0526**

**Notes**

Front Axle Left  
 Front Axle Right  
 Lower  
 Rubber/Metal  
 without holder

Height [mm] 60  
 Inner Diameter [mm] 14.9  
 Outer Diameter [mm] 55.4  
 Required quantity 2  
 replacement in pairs recommended



**References**

Mercedes-Benz 212 330 19 11 Mercedes-Benz A 212 330 19 11

**Application info**

Mercedes-Benz BM 212 (E-Class) (01/09-12/16) Mercedes-Benz BM 218 (CLS) (01/11-12/17)

## Mount, control arm

014 610 0067/HD

MCM0190HD

## Notes

Carbon Neutral  
Front Axle Left  
Lower  
Rear  
Rubber/Metal  
for control arm  
with holder



Height [mm]	59
Inner Diameter [mm]	14
Length [mm]	178
Paired article number	014 610 0068/HD   MCM0191HD
Replace in pairs only	
Required quantity	1
reinforced version	

## References

Mercedes-Benz 247 333 05 00	Mercedes-Benz 247 333 11 00
Mercedes-Benz A 247 333 05 00	Mercedes-Benz A 247 333 11 00
Mercedes-Benz (BBDC) 247 333 05 00	Mercedes-Benz (BBDC) 247 333 11 00
Mercedes-Benz (BBDC) A 247 333 05 00	Mercedes-Benz (BBDC) A 247 333 11 00

## Application info

Mercedes-Benz BM 118 (CLA) (03/19--)	Mercedes-Benz BM 177 (A-Class) (03/18--)
Mercedes-Benz BM 243 (EQA) (02/21--)	Mercedes-Benz BM 243 (EQB) (12/21--)
Mercedes-Benz BM 247 (B-Class) (12/18--)	Mercedes-Benz BM 247 (GLA-Class) (02/20--)
Mercedes-Benz BM 247 (GLB-Class) (08/19--)	

Mount, control arm

014 610 0068/HD

MCM0191HD

Notes

Carbon Neutral  
Front Axle Right  
Lower  
Rear  
Rubber/Metal  
with holder

Height [mm] 59  
Inner Diameter [mm] 14  
Length [mm] 178  
Paired article number 014 610 0067/HD | MCM0190HD  
Replace in pairs only  
Required quantity 1  
reinforced version



References

Mercedes-Benz 247 333 06 00	Mercedes-Benz 247 333 12 00
Mercedes-Benz A 247 333 06 00	Mercedes-Benz A 247 333 12 00
Mercedes-Benz (BBDC) 247 333 06 00	Mercedes-Benz (BBDC) 247 333 12 00
Mercedes-Benz (BBDC) A 247 333 06 00	Mercedes-Benz (BBDC) A 247 333 12 00

Application info

Mercedes-Benz BM 118 (CLA) (03/19--)	Mercedes-Benz BM 177 (A-Class) (03/18--)
Mercedes-Benz BM 243 (EQA) (02/21--)	Mercedes-Benz BM 243 (EQB) (12/21--)
Mercedes-Benz BM 247 (B-Class) (12/18--)	Mercedes-Benz BM 247 (GLA-Class) (02/20--)
Mercedes-Benz BM 247 (GLB-Class) (08/19--)	

Mount, control arm

014 610 0070

MCB0549

Notes

Front  
Front Axle Left  
Front Axle Right  
Lower  
Rubber/Metal  
without holder

Height [mm] 68  
Inner Diameter [mm] 14.5  
Outer Diameter [mm] 50  
Required quantity 2  
replacement in pairs recommended



**References**

- |                                    |                                      |
|------------------------------------|--------------------------------------|
| Mercedes-Benz 247 330 06 00        | Mercedes-Benz 247 330 54 00          |
| Mercedes-Benz 247 330 74 02        | Mercedes-Benz 247 330 76 02          |
| Mercedes-Benz 247 333 30 00        | Mercedes-Benz A 247 330 06 00        |
| Mercedes-Benz A 247 330 54 00      | Mercedes-Benz A 247 330 74 02        |
| Mercedes-Benz A 247 330 76 02      | Mercedes-Benz A 247 333 30 00        |
| Mercedes-Benz (BBDC) 247 330 76 02 | Mercedes-Benz (BBDC) A 247 330 76 02 |

**Application info**

- |  |  |
|--|--|
| Mercedes-Benz BM 177 (A-Class) (03/18--) | Mercedes-Benz BM 247 (B-Class) (12/18--) |
|--|--|

**Mount, control arm**

014 610 0072

MCB0545

**Notes**

- Front
- Front Axle Left
- Front Axle Right
- Lower
- without holder

- Height [mm] 80
- Inner Diameter [mm] 14
- Outer Diameter [mm] 75
- Required quantity 2
- replacement in pairs recommended



**References**

- |                               |                               |
|-------------------------------|-------------------------------|
| Mercedes-Benz 205 333 21 00   | Mercedes-Benz 213 330 21 00   |
| Mercedes-Benz 213 330 22 00   | Mercedes-Benz A 205 333 21 00 |
| Mercedes-Benz A 213 330 21 00 | Mercedes-Benz A 213 330 22 00 |

**Application info**

- |  |  |
|--|--|
| Mercedes-Benz BM 213 (E-Class) (01/16--) | Mercedes-Benz BM 257 (CLS-Class) (12/17--) |
|--|--|

**Mount, control arm**

014 610 0073/HD

MCB0565HD

**Notes**

Carbon Neutral  
 Front Axle Left  
 Front Axle Right  
 Lower  
 Rear  
 without holder

Height [mm] 59  
 Inner Diameter [mm] 14  
 Outer Diameter [mm] 71.5  
 Replace in pairs only  
 Required quantity 2



**References**

Mercedes-Benz 247 333 06 00  
 Mercedes-Benz A 247 333 06 00  
 Mercedes-Benz (BBDC) 247 333 06 00  
 Mercedes-Benz (BBDC) A 247 333 06 00

Mercedes-Benz 247 333 12 00  
 Mercedes-Benz A 247 333 12 00  
 Mercedes-Benz (BBDC) 247 333 12 00  
 Mercedes-Benz (BBDC) A 247 333 12 00

**Application info**

Mercedes-Benz BM 118 (CLA) (03/19--)  
 Mercedes-Benz BM 243 (EQA) (02/21--)  
 Mercedes-Benz BM 247 (B-Class) (12/18--)  
 Mercedes-Benz BM 247 (GLB-Class) (08/19--)

Mercedes-Benz BM 177 (A-Class) (03/18--)  
 Mercedes-Benz BM 243 (EQB) (12/21--)  
 Mercedes-Benz BM 247 (GLA-Class) (02/20--)

**Mount, control arm**

014 610 0076

MCM0194

**Notes**

Rear Axle Left  
 Rear Axle Right

Height [mm] 48  
 Inner Diameter [mm] 12  
 Outer Diameter [mm] 45  
 Paired article number 014 710 0046 | MCB0571  
 Required quantity 2  
 replacement in pairs recommended



**References**

Mercedes-Benz 167 350 25 00

Mercedes-Benz A 167 350 25 00

**Application info**

Mercedes-Benz BM 167 (GLE) (10/18--)

Mercedes-Benz BM 167 (GLS) (04/19--)

**Mount, control arm**

014 610 0077

MCB0577

**Notes**

Front Axle Left  
 Front Axle Right  
 Lower  
 Rear  
 Rubber-Metal Mount  
 Rubber/Metal  
 without holder

Height [mm] 85  
 Inner Diameter [mm] 16.5  
 Outer Diameter [mm] 77  
 Required quantity 2  
 replacement in pairs recommended

**References**

Mercedes-Benz 910 330 25 00  
 Mercedes-Benz A 910 330 25 00

Mercedes-Benz 910 330 26 00  
 Mercedes-Benz A 910 330 26 00

**Application info**

Mercedes-Benz BM 907 / 910 (Sprinter III) (02/18--)

**Mount, control arm**

014 610 0078

MCB0578

**Notes**

Front  
 Front Axle Left  
 Front Axle Right  
 Lower  
 Rubber-Metal Mount  
 Rubber/Metal  
 without holder

Height [mm] 79  
 Inner Diameter [mm] 16  
 Outer Diameter [mm] 59.3  
 Required quantity 2  
 replacement in pairs recommended

**References**

Mercedes-Benz 910 330 25 00  
 Mercedes-Benz A 910 330 25 00

Mercedes-Benz 910 330 26 00  
 Mercedes-Benz A 910 330 26 00

**Application info**

Mercedes-Benz BM 907 / 910 (Sprinter III) (02/18--)



**Mount, control arm**

014 710 0004

MCB0472

**Notes**

Lower  
Rear Axle Left  
Rear Axle Right  
inner  
without holder

Height [mm] 58  
Inner Diameter [mm] 12  
Outer Diameter [mm] 51  
Required quantity 2  
replacement in pairs recommended



**References**

Mercedes-Benz 203 352 00 65

Mercedes-Benz A 203 352 00 65

**Application info**

Mercedes-Benz BM 203 (C-Class) (05/00-06/11)

Mercedes-Benz BM 209 (CLK) (05/02-03/10)

**Mount, control arm**

014 710 0023

MCB0442

**Notes**

Rear Axle Left  
Rear Axle Right  
Upper  
for trailing arm  
inner  
without holder

Height [mm] 38  
Inner Diameter [mm] 12  
Outer Diameter [mm] 39.5  
Quantity per axle 2  
Required quantity 2  
replacement in pairs recommended



**References**

Mercedes-Benz 164 350 13 06

Mercedes-Benz 164 350 16 06

Mercedes-Benz 164 352 03 65

Mercedes-Benz 166 353 19 00

Mercedes-Benz 167 352 18 00

Mercedes-Benz A 164 350 13 06

Mercedes-Benz A 164 350 16 06

Mercedes-Benz A 164 352 03 65

Mercedes-Benz A 166 353 19 00

Mercedes-Benz A 167 352 18 00

**Application info**

Mercedes-Benz BM 164 (GL-Class) (09/06-12/12)  
 Mercedes-Benz BM 166 (GL) (07/12-12/15)  
 Mercedes-Benz BM 166 (GLS) (11/15-04/19)  
 Mercedes-Benz BM 167 (GLE) (10/18--)  
 Mercedes-Benz BM 251 (R-Class) (08/05-10/17)

Mercedes-Benz BM 164 (M-Class) (02/05-12/12)  
 Mercedes-Benz BM 166 (GLE) (03/15-10/19)  
 Mercedes-Benz BM 166 (M-Class) (06/11-12/15)  
 Mercedes-Benz BM 167 (GLS) (04/19--)

**Mount, control arm**

014 710 0033

MCB0486

**Notes**

Rear Axle Left  
 Rear Axle Right  
 Rubber/Metal  
 without holder

Height [mm] 62  
 Inner Diameter [mm] 16  
 Outer Diameter [mm] 50  
 Quantity per axle 2  
 Required quantity 2  
 replacement in pairs recommended



**References**

Mercedes-Benz 164 326 06 81  
 Mercedes-Benz A 164 326 06 81

Mercedes-Benz 166 326 02 81  
 Mercedes-Benz A 166 326 02 81

**Application info**

Mercedes-Benz BM 164 (GL-Class) (09/06-12/12)  
 Mercedes-Benz BM 166 (GL) (07/12-12/15)  
 Mercedes-Benz BM 166 (GLS) (11/15-04/19)  
 Mercedes-Benz BM 251 (R-Class) (08/05-10/17)

Mercedes-Benz BM 164 (M-Class) (02/05-12/12)  
 Mercedes-Benz BM 166 (GLE) (03/15-10/19)  
 Mercedes-Benz BM 166 (M-Class) (06/11-12/15)

**Mount, control arm**

014 710 0036

MCB0524

**Notes**

Rear Axle Left  
 Rear Axle Right  
 Upper  
 outer  
 without holder

Height [mm] 41  
 Inner Diameter [mm] 12  
 Outer Diameter [mm] 39.5  
 Quantity per axle 8  
 Required quantity 2  
 replacement in pairs recommended



**References**

Mercedes-Benz 166 352 09 00  
Mercedes-Benz A 166 352 09 00

Mercedes-Benz 167 352 19 00  
Mercedes-Benz A 167 352 19 00

**Application info**

Mercedes-Benz BM 167 (GLE) (10/18--)  
Mercedes-Benz BM 251 (R-Class) (08/05-10/17)

Mercedes-Benz BM 167 (GLS) (04/19--)

**Mount, control arm**

014 710 0043

MCB0539

**Notes**

Front  
Rear Axle Left  
Rear Axle Right  
Rubber/Metal  
without holder

Height [mm] 38  
Inner Diameter [mm] 40  
Outer Diameter [mm] 82  
Required quantity 2  
replacement in pairs recommended



**References**

Mercedes-Benz 246 350 04 06  
Mercedes-Benz A 246 350 04 06

Mercedes-Benz 246 350 05 06  
Mercedes-Benz A 246 350 05 06

**Application info**

Mercedes-Benz BM 117 (CLA) (01/13-03/19)  
Mercedes-Benz BM 176 (A-Class) (06/12-05/18)

Mercedes-Benz BM 156 (GLA-Class) (12/13--)  
Mercedes-Benz BM 246 (B-Class) (10/11-12/18)

**Mount, control arm**

014 710 0046

MCB0571

**Notes**

Rear Axle Left  
Rear Axle Right  
for control arm  
without holder

Height [mm] 43  
Inner Diameter [mm] 12.1  
Outer Diameter [mm] 39.9  
Paired article number 014 610 0076 | MCM0194  
Required quantity 2  
replacement in pairs recommended



**References**

Mercedes-Benz 167 350 25 00

Mercedes-Benz A 167 350 25 00

**Application info**

Mercedes-Benz BM 167 (GLE) (10/18--)

Mercedes-Benz BM 167 (GLS) (04/19--)

**Mount, control arm****100 199 0085/HD****MCM0003HD****Notes**

Carbon Neutral  
 Front Axle Left  
 Rear  
 with holder  
 with rubber mount

Height [mm]

50

Inner Diameter [mm]

18

Paired article number

100 199 0086/HD | MCM0004HD

Replace in pairs only

Required quantity

1

reinforced version

**References**

Audi 1K0 199 231 G

Audi 1K0 199 231 J

Audi 1K0 199 231 K

Seat 1K0 199 231 J

Seat 1K0 199 231 K

Skoda 1K0 199 231 J

Skoda (SVW) 1K0 199 231 J

Volkswagen 1K0 199 231 G

Volkswagen 1K0 199 231 J

Volkswagen 1K0 199 231 K

Volkswagen 2K0 199 231

Volkswagen (FAW) 1K0 199 231

**Application info**

Audi A3 II (8P\_) (05/03-12/15)

Seat Leon II / Toledo III / Altea (1P\_ ,5P\_) (03/04--)

Skoda Octavia II (1Z\_) (02/04-06/13)

Skoda Superb II (3T) (03/08-05/15)

Skoda Yeti (5L) (05/09-12/17)

Volkswagen Beetle (5C1) (04/11-07/19)

Volkswagen Bora V (Mex) (01/07--)

Volkswagen Caddy III (2KA, 2KB) (03/04-05/15)

Volkswagen Caddy IV (SA\_) (05/15--)

Volkswagen Eos (03/06-08/15)

Volkswagen Golf V (1K1, 1K5, 5M1) (10/03-08/14)

Volkswagen Golf VI (5K1, 517, AJ5) (10/08-05/16)

Volkswagen Jetta III (1K2) (09/04-12/13)

Volkswagen Scirocco III (137) (05/08-11/17)

Volkswagen Touran I (1T1/2/3) (02/03-05/15)

## Mount, control arm

100 199 0086/HD

MCM0004HD

## Notes

Carbon Neutral  
 Front Axle Right  
 Rear  
 with holder  
 with rubber mount

Height [mm] 50  
 Inner Diameter [mm] 18  
 Paired article number 100 199 0085/HD | MCM0003HD  
 Replace in pairs only  
 Required quantity 1  
 reinforced version



## References

Audi 1K0 199 232 G	Audi 1K0 199 232 J
Audi 1K0 199 232 K	Seat 1K0 199 232 J
Seat 1K0 199 232 K	Skoda 1K0 199 232 J
Skoda (SVW) 1K0 199 232 J	Volkswagen 1K0 199 232 G
Volkswagen 1K0 199 232 J	Volkswagen 1K0 199 232 K
Volkswagen 2K0 199 232	Volkswagen (FAW) 1K0 199 232 J

## Application info

Audi A3 II (8P_) (05/03-12/15)	Seat Leon II / Toledo III / Altea (1P_ ,5P_) (03/04--)
Skoda Octavia II (1Z_) (02/04-06/13)	Skoda Superb II (3T) (03/08-05/15)
Skoda Yeti (5L) (05/09-12/17)	Volkswagen Beetle (5C1) (04/11-07/19)
Volkswagen Bora V (Mex) (01/07--)	Volkswagen Caddy III (2KA, 2KB) (03/04-05/15)
Volkswagen Caddy IV (SA_) (05/15--)	Volkswagen Eos (03/06-08/15)
Volkswagen Golf V (1K1, 1K5, 5M1) (10/03-08/14)	Volkswagen Golf VI (5K1, 517, AJ5) (10/08-05/16)
Volkswagen Jetta III (1K2) (09/04-12/13)	Volkswagen Scirocco III (137) (05/08-11/17)
Volkswagen Touran I (1T1/2/3) (02/03-05/15)	

## Mount, control arm

100 407 0022/HD

MCB0050HD

## Notes

Carbon Neutral  
 Front  
 Front Axle Left  
 Front Axle Right  
 Lower  
 inner  
 without holder

Height [mm]

60

Inner Diameter [mm]

32

Outer Diameter [mm]

50

Replace in pairs only

Required quantity

2

reinforced version



## References

Audi 4D0 407 182 E

Audi 4D0 407 182 G

Audi 4Z7 407 182

Audi (FAW) 4D0 407 182 E

Audi (FAW) 4D0 407 182 G

Seat 4D0 407 182 G

Skoda 4D0 407 182 E

Skoda 4D0 407 182 G

Volkswagen 4D0 407 182 E

Volkswagen 4D0 407 182 G

Volkswagen (SVW) 4D0 407 182 E

Volkswagen (SVW) 4D0 407 182 G

## Application info

Audi A4 Cabriolet (8H\_) (01/02-12/09)

Audi A4 I (8D\_) (11/94-12/02)

Audi A4 II (8E\_) (02/00-12/05)

Audi A4 III (8E\_) (11/04-06/08)

Audi A6 II (4B, C5) (01/97-12/05)

Audi A6 III (4F2, 4FH, 4F5) (04/04-08/11)

Audi A8 I (4D\_) (03/94-12/05)

Audi Allroad (4BH) (05/00-08/05)

Seat Exeo (3R) (12/08-05/13)

Skoda Superb I (3U) (12/01-03/08)

Volkswagen Passat (3B\_) (08/96-12/05)

**Mount, control arm****100 407 0024/HD****MCB0051HD****Notes**

Carbon Neutral  
 Front Axle Left  
 Front Axle Right  
 Upper  
 without holder

Height [mm]

40

Inner Diameter [mm]

10

Outer Diameter [mm]

47

Replace in pairs only

Required quantity

2

reinforced version

**References**

Audi 4B0 407 515

Audi (FAW) 4B0 407 515

Skoda 4B0 407 515

Volkswagen 4B0 407 515

Volkswagen (SVW) 4B0 407 515

Audi 4D0 407 515 C

Audi (FAW) 4D0 407 515 C

Skoda 4D0 407 515 C

Volkswagen 4D0 407 515 C

**Application info**

Audi A4 Cabriolet (8H\_) (01/02-12/09)

Audi A4 II (8E\_) (02/00-12/05)

Audi A8 I (4D\_) (03/94-12/05)

Skoda Superb I (3U) (12/01-03/08)

Audi A4 I (8D\_) (11/94-12/02)

Audi A6 II (4B, C5) (01/97-12/05)

Audi Allroad (4BH) (05/00-08/05)

Volkswagen Passat (3B\_) (08/96-12/05)

**Mount, control arm****100 407 0041****MCB0058****Notes**

Front Axle Left  
 Front Axle Right  
 Lower  
 Rear  
 without holder

Height [mm]

46

Inner Diameter [mm]

17

Outer Diameter [mm]

61

Required quantity

2

replacement in pairs recommended

**References**

Seat 6N0 407 181

Volkswagen 6N0 407 181

**Application info**

Seat Arosa (6H) (05/97-06/04)

Volkswagen Lupo (09/98-07/05)

Volkswagen Polo (6N\_) (09/94-10/01)

**Mount, control arm****100 407 0043****MCB0060****Notes**

Front Axle Left  
 Front Axle Right  
 Lower  
 Rear  
 without holder

Height [mm]

41

Inner Diameter [mm]

13

Outer Diameter [mm]

60

Required quantity

2

replacement in pairs recommended

**References**

Audi 1J0 407 181

Audi 1J0 407 181 A

Seat 1J0 407 181

Seat 1J0 407 181 A

Skoda 1J0 407 181

Skoda 1J0 407 181 A

Skoda (SVW) 180 407 181

Volkswagen 1J0 407 181

Volkswagen 1J0 407 181 A

Volkswagen (FAW) 1J0 407 181

Volkswagen (FAW) L1J0 407 181

Volkswagen (SVW) 180 407 181

**Application info**

Audi A1 I (8X\_) (05/10-10/18)

Audi A3 I (8L\_) (09/96-09/06)

Audi TT I (8N\_) (10/98-12/06)

Seat Ibiza IV (6J\_, 6P\_) (03/08-12/18)

Seat Leon I / Toledo II (1M\_) (10/98-06/06)

Seat Mii (10/11--)

Seat Toledo IV (KG3) (07/12-04/19)

Skoda Citigo (10/11--)

Skoda Fabia II (54\_) (12/06-12/14)

Skoda Fabia III (NJ\_) (08/14--)

Skoda Octavia I (1U\_) (09/96-12/10)

Skoda Rapid II (N\_) (07/12-12/19)

Skoda Roomster (03/06-05/15)

Volkswagen Bora (1J2, 1J6) (10/98-12/13)

Volkswagen Bora V (Mex) (01/07--)

Volkswagen Gol III (06/08--)

Volkswagen Golf IV (1J1, 1J5) (08/97-06/14)

Volkswagen Golf VI (5K1, 517, AJ5) (10/08-05/16)

Volkswagen Jetta City (09/06-12/09)

Volkswagen New Beetle (1Y7, 9C1, 1C1) (01/98-12/11)

Volkswagen Passat (3B\_) (08/96-12/05)

Volkswagen Polo (6R\_) (03/09--)

Volkswagen Polo (9N\_) (10/01--)

Volkswagen Polo Vivo (6R1, 6RS) (07/17--)

Volkswagen UP (08/11--)



**Mount, control arm****100 407 0047/HD****MCB0061HD****Notes**

Carbon Neutral  
 Front  
 Front Axle Left  
 Front Axle Right  
 Lower  
 outer  
 without holder

Height [mm] 50  
 Inner Diameter [mm] 12  
 Outer Diameter [mm] 40  
 Replace in pairs only  
 Required quantity 2  
 reinforced version

**References**

Audi 4D0 407 181 F  
 Audi (FAW) 4D0 407 181 H  
 Skoda 4D0 407 181 H  
 Volkswagen 4D0 407 181 H

Audi 4D0 407 181 H  
 Skoda 4D0 407 181 F  
 Volkswagen 4D0 407 181 F  
 Volkswagen (SVW) 4D0 407 181 H

**Application info**

Audi A4 I (8D\_) (11/94-12/02)  
 Audi A8 I (4D\_) (03/94-12/05)  
 Skoda Superb I (3U) (12/01-03/08)

Audi A6 II (4B, C5) (01/97-12/05)  
 Audi Allroad (4BH) (05/00-08/05)  
 Volkswagen Passat (3B\_) (08/96-12/05)

**Mount, control arm****100 407 0049****MCB0062****Notes**

Aluminium  
 Front Axle Left  
 Front Axle Right  
 Lower  
 Rear  
 without holder

Height [mm] 41  
 Inner Diameter [mm] 17  
 Outer Diameter [mm] 60  
 Required quantity 2  
 replacement in pairs recommended



**References**

Seat 191 407 181 A

Seat 191 407 181 D

Seat 357 407 181

Volkswagen 191 407 181 B

Volkswagen 191 407 181 E

Volkswagen (FAW) 191 407 181 D

Seat 191 407 181 B

Seat 191 407 181 E

Volkswagen 191 407 181 A

Volkswagen 191 407 181 D

Volkswagen 357 407 181

**Application info**

Seat Ibiza II / Cordoba I / Inca (6K\_) (02/93-11/03)

Volkswagen Caddy II (9K9, 9K9B, 9U7) (11/95-06/09)

Volkswagen Golf II (19E) (08/83-12/92)

Volkswagen Jetta II (19E) (08/83-12/92)

Volkswagen Polo (6K\_) (01/95-11/09)

Volkswagen Vento (11/91-09/98)

Seat Toledo I (1L\_) (01/91-10/99)

Volkswagen Corrado (53I) (08/87-12/95)

Volkswagen Golf III (1H1, 1H5, 1E7) (10/89-12/02)

Volkswagen Passat (35I) (02/88-12/97)

Volkswagen Polo Playa (01/95-11/09)

**Mount, control arm****100 407 0049/S****MCB0063****Notes**

Aluminium  
 Front Axle Left  
 Front Axle Right  
 Lower  
 Rear  
 Set  
 without holder

Height [mm]

41

Inner Diameter [mm]

17

Outer Diameter [mm]

60

Required quantity

2

replacement in pairs recommended

**References**

Seat 191 407 181 A

Seat 191 407 181 D

Seat 357 407 181

Volkswagen 191 407 181 B

Volkswagen 191 407 181 E

Seat 191 407 181 B

Seat 191 407 181 E

Volkswagen 191 407 181 A

Volkswagen 191 407 181 D

Volkswagen 357 407 181

**Application info**

Seat Ibiza II / Cordoba I / Inca (6K\_) (02/93-11/03)  
 Volkswagen Caddy II (9K9, 9K9B, 9U7) (11/95-06/09)  
 Volkswagen Golf II (19E) (08/83-12/92)  
 Volkswagen Jetta II (19E) (08/83-12/92)  
 Volkswagen Polo (6K\_) (01/95-11/09)  
 Volkswagen Vento (11/91-09/98)

Seat Toledo I (1L\_) (01/91-10/99)  
 Volkswagen Corrado (53I) (08/87-12/95)  
 Volkswagen Golf III (1H1, 1H5, 1E7) (10/89-12/02)  
 Volkswagen Passat (35I) (02/88-12/97)  
 Volkswagen Polo Playa (01/95-11/09)

**Mount, control arm****100 407 0060/HD****MCB0069HD****Notes**

Carbon Neutral  
 Front Axle Left  
 Front Axle Right  
 Lower  
 Rear  
 without holder

Height [mm] 80  
 Inner Diameter [mm] 12  
 Outer Diameter [mm] 65  
 Replace in pairs only  
 Required quantity 2  
 reinforced version

**References**

Audi 4D0 407 183 AA  
 Audi 4D0 407 183 AC  
 Audi 4D0 407 183 Q  
 Audi (FAW) 4D0 407 183 AB  
 Skoda 4D0 407 183 AB  
 Skoda 4D0 407 183 P  
 Skoda 4F0 407 183 A  
 Volkswagen 4D0 407 183 AB  
 Volkswagen 4D0 407 183 P  
 Volkswagen 4F0 407 183 A  
 Volkswagen (SVW) 4D0 407 183 AB

Audi 4D0 407 183 AB  
 Audi 4D0 407 183 P  
 Audi 4F0 407 183 A  
 Audi (FAW) 4D0 407 183 AC  
 Skoda 4D0 407 183 AC  
 Skoda 4D0 407 183 Q  
 Volkswagen 4D0 407 183 AA  
 Volkswagen 4D0 407 183 AC  
 Volkswagen 4D0 407 183 Q  
 Volkswagen 4F0 407 183 B  
 Volkswagen (SVW) 4D0 407 183 AC

**Application info**

Audi A4 Cabriolet (8H\_) (01/02-12/09)  
 Audi A4 II (8E\_) (02/00-12/05)  
 Audi A6 II (4B, C5) (01/97-12/05)  
 Audi Allroad (4BH) (05/00-08/05)  
 Volkswagen Passat (3B\_) (08/96-12/05)

Audi A4 I (8D\_) (11/94-12/02)  
 Audi A4 III (8E\_) (11/04-06/08)  
 Audi A8 I (4D\_) (03/94-12/05)  
 Skoda Superb I (3U) (12/01-03/08)

## Mount, control arm

100 407 0070/HD

MCB0071HD

## Notes

Carbon Neutral  
 Front Axle Left  
 Front Axle Right  
 Upper  
 without holder

Height [mm]

40

Inner Diameter [mm]

10

Outer Diameter [mm]

47

Replace in pairs only

Required quantity

2

reinforced version



## References

Audi 4E0 407 515 D

Audi 4H0 407 515 A

Audi 8D0 407 515 A

Audi 8D0 407 515 C

Audi 8R0 407 515

Audi (FAW) 8D0 407 515 B

Porsche 8D0 407 515 C

Volkswagen 8D0 407 515 A

Volkswagen 8D0 407 515 C

Audi 4H0 407 515

Audi 4H0 407 515 B

Audi 8D0 407 515 B

Audi 8K0 407 515

Audi (FAW) 4GD 407 515

Audi (FAW) 8D0 407 515 C

Seat 8D0 407 515 C

Volkswagen 8D0 407 515 B

## Application info

Audi A4 Cabriolet (8H\_) (01/02-12/09)

Audi A4 II (8E\_) (02/00-12/05)

Audi A4 IV (8K\_) (08/07-05/16)

Audi A6 II (4B, C5) (01/97-12/05)

Audi A6 IV (4G2, 4G5, C7) (11/10-09/18)

Audi A8 I (4D\_) (03/94-12/05)

Audi A8 III (4H\_) (11/09-01/18)

Porsche Macan (95B) (02/14--)

Volkswagen Phaeton (3D) (04/02-03/16)

Audi A4 I (8D\_) (11/94-12/02)

Audi A4 III (8E\_) (11/04-06/08)

Audi A5 I (8F\_, 8T\_) (06/07-01/17)

Audi A6 III (4F2, 4FH, 4F5) (04/04-08/11)

Audi A7 I Sportback (4G\_) (07/10-05/18)

Audi A8 II (4E\_) (10/02-12/10)

Audi Q5 I (8R\_) (11/08-12/17)

Seat Exeo (3R) (12/08-05/13)

## Mount, control arm

100 407 0073/HD

MCB0072HD

## Notes

Carbon Neutral  
 Front Axle Left  
 Front Axle Right  
 Lower  
 Rear  
 without holder

Height [mm] 41  
 Inner Diameter [mm] 13  
 Outer Diameter [mm] 60  
 Replace in pairs only  
 Required quantity 2  
 reinforced version



## References

Audi 6R0 407 181 B  
 Seat 6R0 407 181 B  
 Skoda 6R0 407 181 B

Audi 8N0 407 181 B  
 Seat 8N0 407 181 B  
 Volkswagen 8N0 407 181 B

## Application info

Audi A1 I (8X\_) (05/10-10/18)  
 Audi TT I (8N\_) (10/98-12/06)  
 Skoda Fabia II (54\_) (12/06-12/14)  
 Skoda Rapid II (N\_) (07/12-12/19)  
 Volkswagen New Beetle (1Y7, 9C1, 1C1) (01/98-12/11)  
 Volkswagen Polo Vivo (6R1, 6RS) (07/17--)

Audi A3 I (8L\_) (09/96-09/06)  
 Seat Ibiza IV (6J\_, 6P\_) (03/08-12/18)  
 Skoda Fabia III (NJ\_) (08/14--)  
 Volkswagen Golf IV (1J1, 1J5) (08/97-06/14)  
 Volkswagen Polo (6R\_) (03/09--)

## Mount, control arm

100 407 0082

MCB0074

## Notes

Front  
 Front Axle Left  
 Front Axle Right  
 Lower  
 outer  
 without holder

Height [mm] 37  
 Inner Diameter [mm] 12  
 Outer Diameter [mm] 40  
 Required quantity 2  
 replacement in pairs recommended



**References**

Audi 8E0 407 181 B  
 Audi 8E0 407 181 D  
 Seat 8E0 407 181 C

Audi 8E0 407 181 C  
 Audi (FAW) 8E0 407 181 C

**Application info**

Audi A4 Cabriolet (8H\_) (01/02-12/09)  
 Audi A4 III (8E\_) (11/04-06/08)

Audi A4 II (8E\_) (02/00-12/05)  
 Seat Exeo (3R) (12/08-05/13)

**Mount, control arm****100 407 0084/HD****MCB0076HD****Notes**

Carbon Neutral  
 Front Axle Left  
 Front Axle Right  
 Lower  
 Rear  
 without holder

Height [mm] 50  
 Inner Diameter [mm] 18  
 Outer Diameter [mm] 60  
 Replace in pairs only  
 Required quantity 2  
 reinforced version

**References**

Ford 1 044 571  
 Ford 95VW-3A262-BA  
 Seat 7M0 407 181 A

Ford 7 396 830  
 Ford 95VW-5A638-DA  
 Volkswagen 7M0 407 181 A

**Application info**

Ford Galaxy I (03/95-05/06)  
 Volkswagen Sharan (7M) (05/95-03/10)

Seat Alhambra I (7V8, 7V9) (03/96-03/10)

## Mount, control arm

100 407 0086

MCB0077

## Notes

Front  
 Front Axle Left  
 Front Axle Right  
 Lower  
 without holder

Height [mm] 54  
 Inner Diameter [mm] 12  
 Outer Diameter [mm] 40  
 Required quantity 2  
 replacement in pairs recommended



## References

Audi 1K0 407 182	Audi 1K0 407 182 A
Audi 1K0 407 182 F	Audi 5Q0 407 182
Audi 5Q0 407 182 A	Audi (FAW) 1K0407182F
Audi (FAW) 5Q0 407 182	Seat 1K0 407 182
Seat 1K0 407 182 A	Seat 1K0 407 182 F
Seat 5Q0 407 182 A	Skoda 1K0 407 182
Skoda 1K0 407 182 A	Skoda 1K0 407 182 F
Skoda 5Q0 407 182	Skoda 5Q0 407 182 A
Skoda (SVW) 1K0 407 182	Volkswagen 1K0 407 182
Volkswagen 1K0 407 182 A	Volkswagen 1K0 407 182 F
Volkswagen 5Q0 407 182	Volkswagen 5Q0 407 182 A
Volkswagen (FAW) 1K0407182F	Volkswagen (FAW) 1KD 407 182
Volkswagen (FAW) 5Q0 407 182	Volkswagen (SVW) 1K0 407 182
Volkswagen (SVW) 1K0407182F	

**Application info**

Audi A3 II (8P_) (05/03-12/15)	Audi A3 III (8V_) (04/12--)
Audi A3 IV (8Y_) (11/19--)	Audi Q2 (06/16--)
Audi Q3 I (8U_) (06/11-12/18)	Audi Q3 II (F3_) (07/18--)
Audi TT II (8J_) (07/06-01/15)	Audi TT III (8S_) (07/14--)
CUPRA ATECA (KH7_KHP) (09/18--)	CUPRA FORMENTOR (KM_) (07/20--)
Seat Alhambra II (710) (06/10--)	Seat Ateca (04/16--)
Seat Ibiza II / Cordoba I / Inca (6K_) (02/93-11/03)	Seat Leon II / Toledo III / Altea (1P_ ,5P_) (03/04--)
Seat Leon III (5F_) (09/12--)	Seat Tarraco (09/18--)
Skoda Karoq (07/17--)	Skoda Kodiaq I (10/16--)
Skoda Kodiaq II (01/24--)	Skoda Octavia II (1Z_) (02/04-06/13)
Skoda Octavia III (5E_) (11/12--)	Skoda Octavia IV (NX_) (11/19--)
Skoda Superb II (3T) (03/08-05/15)	Skoda Superb III (3V_) (03/15--)
Skoda Superb IV (NZ_) (11/23--)	Skoda Yeti (5L) (05/09-12/17)
Volkswagen Arteon (03/17--)	Volkswagen Beetle (5C1) (04/11-07/19)
Volkswagen Bora V (Mex) (01/07--)	Volkswagen Caddy III (2KA, 2KB) (03/04-05/15)
Volkswagen Caddy IV (SA_) (05/15--)	Volkswagen Eos (03/06-08/15)
Volkswagen Golf V (1K1, 1K5, 5M1) (10/03-08/14)	Volkswagen Golf VI (5K1, 517, AJ5) (10/08-05/16)
Volkswagen Golf VII (5G1,BA5) (08/12--)	Volkswagen Golf VIII (CB1) (07/19--)
Volkswagen Jetta III (1K2) (09/04-12/13)	Volkswagen Jetta IV (162) (01/08--)
Volkswagen Jetta VII (BU3) (12/17--)	Volkswagen Passat (362, 365) (08/10-12/15)
Volkswagen Passat (3C_) (03/05-01/12)	Volkswagen Passat (A32) (01/11--)
Volkswagen Passat (B8) (08/14--)	Volkswagen Scirocco III (137) (05/08-11/17)
Volkswagen Sharan (7N) (05/10--)	Volkswagen T-Roc (A11) (07/17--)
Volkswagen Taos (CL1, CQ1) (10/20--)	Volkswagen Tiguan I (5N) (09/07-07/18)
Volkswagen Tiguan II (AD1, BW2) (01/16--)	Volkswagen Touran I (1T1/2/3) (02/03-05/15)
Volkswagen Touran II (5T1) (05/15--)	

**Mount, control arm****100 407 0089****MCB0078****Notes**

Front Axle Left  
 Front Axle Right  
 Lower  
 for control arm  
 without holder

Height [mm]	48
Inner Diameter [mm]	15
Outer Diameter [mm]	36
Required quantity	2
replacement in pairs recommended	





**References**

Audi 8Z0 407 182 B  
Audi 8Z0 407 195 D

Audi 8Z0 407 182 C

**Application info**

Audi A2 (8Z0) (02/00-08/05)

**Mount, control arm**

100 407 0094

MCB0081

**Notes**

Front  
Front Axle Left  
Front Axle Right  
Lower  
without holder

Height [mm] 54  
Inner Diameter [mm] 12  
Outer Diameter [mm] 34  
Required quantity 2  
replacement in pairs recommended

**References**

Seat 6Q0 407 182 A  
Volkswagen 6Q0 407 182 A

Skoda 6Q0 407 182 A  
Volkswagen (SVW) 6Q0 407 151 L

**Application info**

Seat Ibiza III / Cordoba II (6L\_) (02/02-11/09)  
Skoda Roomster (03/06-05/15)  
Volkswagen Polo (9N\_) (10/01--)

Skoda Fabia I (6Y\_) (08/99-03/08)  
Volkswagen Fox/Lupo (Z51) (08/03--)

**Mount, control arm**

100 407 0095/HD

MCB0082HD

**Notes**

Carbon Neutral  
Front Axle Left  
Front Axle Right  
Lower  
Rear  
without holder

Height [mm] 80  
Inner Diameter [mm] 12  
Outer Diameter [mm] 65  
Replace in pairs only  
Required quantity 2  
reinforced version



**References**

Audi 4F0 407 183 C  
 Audi 4F0 407 183 F  
 Audi 8K0 407 183 B  
 Audi (FAW) 4F0 407 183 E

Audi 4F0 407 183 E  
 Audi 8K0 407 183 A  
 Audi (FAW) 4F0 407 183 C  
 Seat 4F0 407 183 E

**Application info**

Audi A4 Cabriolet (8H\_) (01/02-12/09)  
 Audi A4 IV (8K\_) (08/07-05/16)  
 Audi A6 III (4F2, 4FH, 4F5) (04/04-08/11)  
 Audi Q5 I (8R\_) (11/08-12/17)  
 Volkswagen Phaeton (3D) (04/02-03/16)

Audi A4 III (8E\_) (11/04-06/08)  
 Audi A5 I (8F\_ , 8T\_) (06/07-01/17)  
 Audi A8 II (4E\_) (10/02-12/10)  
 Seat Exeo (3R) (12/08-05/13)

**Mount, control arm****100 505 0014****MCM0011****Notes**

Rear Axle Left  
 Rear Axle Right  
 for trailing arm  
 without holder

Height [mm] 64  
 Inner Diameter [mm] 12  
 Outer Diameter [mm] 60  
 Required quantity 2  
 replacement in pairs recommended

**References**

Audi 1K0 505 541 B  
 Audi 1K0 505 541 D  
 Seat 1K0 505 541 B  
 Seat 1K0 505 541 D  
 Skoda 1K0 505 541 B  
 Skoda 1K0 505 541 D  
 Volkswagen 1K0 505 541 B  
 Volkswagen 1K0 505 541 D

Audi 1K0 505 541 C  
 Audi 5Q0 505 541 A  
 Seat 1K0 505 541 C  
 Seat 5Q0 505 541 A  
 Skoda 1K0 505 541 C  
 Skoda 5Q0 505 541 A  
 Volkswagen 1K0 505 541 C  
 Volkswagen 5Q0 505 541 A

**Application info**

Audi A1 I (8X_) (05/10-10/18)	Audi A3 II (8P_) (05/03-12/15)
Audi A3 III (8V_) (04/12--)	Audi A3 IV (8Y_) (11/19--)
Audi Q2 (06/16--)	Audi Q3 I (8U_) (06/11-12/18)
Audi Q3 II (F3_) (07/18--)	Audi TT II (8J_) (07/06-01/15)
Audi TT III (8S_) (07/14--)	CUPRA ATECA (KH7_KHP) (09/18--)
Seat Alhambra II (710) (06/10--)	Seat Ateca (04/16--)
Seat Leon II / Toledo III / Altea (1P_ ,5P_) (03/04--)	Seat Leon III (5F_) (09/12--)
Seat Tarraco (09/18--)	Skoda Karoq (07/17--)
Skoda Kodiaq I (10/16--)	Skoda Octavia II (1Z_) (02/04-06/13)
Skoda Octavia III (5E_) (11/12--)	Skoda Octavia IV (NX_) (11/19--)
Skoda Superb II (3T) (03/08-05/15)	Skoda Superb III (3V_) (03/15--)
Skoda Yeti (5L) (05/09-12/17)	Volkswagen Arteon (03/17--)
Volkswagen Beetle (5C1) (04/11-07/19)	Volkswagen Eos (03/06-08/15)
Volkswagen Golf IV (1J1, 1J5) (08/97-06/14)	Volkswagen Golf V (1K1, 1K5, 5M1) (10/03-08/14)
Volkswagen Golf VI (5K1, 517, AJ5) (10/08-05/16)	Volkswagen Golf VII (5G1,BA5) (08/12--)
Volkswagen Golf VIII (CB1) (07/19--)	Volkswagen Jetta III (1K2) (09/04-12/13)
Volkswagen Jetta IV (162) (01/08--)	Volkswagen Jetta VII (BU3 ) (12/17--)
Volkswagen Passat (3C_) (03/05-01/12)	Volkswagen Passat (A32) (01/11--)
Volkswagen Passat (B8) (08/14--)	Volkswagen Scirocco III (137) (05/08-11/17)
Volkswagen Sharan (7N) (05/10--)	Volkswagen T-Roc (A11) (07/17--)
Volkswagen Taos (CL1, CQ1) (10/20--)	Volkswagen Tiguan I (5N ) (09/07-07/18)
Volkswagen Tiguan II (AD1, BW2 ) (01/16--)	Volkswagen Touran I ( 1T1/2/3) (02/03-05/15)
Volkswagen Touran II (5T1 ) (05/15--)	

**Mount, control arm****100 610 0002/HD****MCB0458HD****Notes**

Carbon Neutral  
 Front Axle Left  
 Front Axle Right  
 Rear  
 without holder

Height [mm]	64
Inner Diameter [mm]	14
Outer Diameter [mm]	60
Replace in pairs only	
Required quantity	2
reinforced version	

**References**

Volkswagen 7H0 407 182

Volkswagen 7H0 407 182 A

**Application info**

Volkswagen Transporter V (04/03-08/15)

Volkswagen Transporter VI (04/15--)

**Mount, control arm****100 610 0003/HD****MCB0095HD****Notes**

Carbon Neutral  
 Front  
 Front Axle Left  
 Front Axle Right  
 Lower  
 outer  
 without holder

Height [mm]

45

Inner Diameter [mm]

12

Outer Diameter [mm]

44

Replace in pairs only

Required quantity

2

reinforced version

**References**

Audi 4E0 407 181 B

Audi (FAW) 4GD 407 181

Audi (FAW) 4E0 407 181 B

Porsche 4E0 407 181 B

**Application info**

Audi A4 IV (8K\_) (08/07-05/16)

Audi A5 I (8F\_, 8T\_) (06/07-01/17)

Audi A6 III (4F2, 4FH, 4F5) (04/04-08/11)

Audi A7 I Sportback (4G\_) (07/10-05/18)

Audi A8 III (4H\_) (11/09-01/18)

Porsche Macan (95B) (02/14--)

Audi A4 V (8W\_) (05/15--)

Audi A5 II (F5\_) (06/16--)

Audi A6 IV (4G2, 4G5, C7) (11/10-09/18)

Audi A8 II (4E\_) (10/02-12/10)

Audi Q5 I (8R\_) (11/08-12/17)

**Mount, control arm****100 610 0004/HD****MCB0096HD****Notes**

Carbon Neutral  
 Front  
 Front Axle Left  
 Front Axle Right  
 Lower  
 inner  
 without holder

Height [mm] 60  
 Inner Diameter [mm] 12  
 Outer Diameter [mm] 55  
 Replace in pairs only  
 Required quantity 2  
 reinforced version

**References**

Audi 4E0 407 182 C

Audi (FAW) 4E0 407 182 C

Volkswagen 4E0 407 182 C

**Application info**

Audi A6 III (4F2, 4FH, 4F5) (04/04-08/11)

Audi A7 I Sportback (4G\_) (07/10-05/18)

Audi A8 II (4E\_) (10/02-12/10)

Volkswagen Phaeton (3D) (04/02-03/16)

**Mount, control arm****100 610 0008****MCB0098****Notes**

Front  
 Front Axle Left  
 Front Axle Right  
 Rubber-Metal Mount  
 without holder

Height [mm] 47  
 Inner Diameter [mm] 14  
 Outer Diameter [mm] 40  
 Required quantity 2  
 replacement in pairs recommended

**References**

Volkswagen 2H0 407 183 A

Volkswagen 7H0 407 151 B

Volkswagen 7H0 407 152 B

Volkswagen 7H0 407 183

**Application info**

Volkswagen Amarok I (09/10--)

Volkswagen Transporter VI (04/15--)

Volkswagen Transporter V (04/03-08/15)

**Mount, control arm**

100 610 0011

MCB0100

**Notes**

Front  
Front Axle Left  
Front Axle Right  
Lower  
without holder

Height [mm]

60

Inner Diameter [mm]

14

Outer Diameter [mm]

40

Required quantity

2

replacement in pairs recommended



**References**

Audi 7L0 407 183 A

Porsche 955 341 588 10

Audi 7L8 407 183

Volkswagen 7L0 407 183 A

**Application info**

Audi Q7 I (4L\_) (03/06-01/16)

Porsche Cayenne II (92A) (06/10--)

Volkswagen Touareg II (7P5) (01/10-12/18)

Porsche Cayenne I (955) (09/02-12/10)

Volkswagen Touareg I (7LA, 7L6, 7L7) (10/02-01/13)

**Mount, control arm**

100 610 0012

MCB0101

**Notes**

Front Axle Left  
Front Axle Right  
Lower  
outer  
without holder

Height [mm]

74

Inner Diameter [mm]

14

Outer Diameter [mm]

47

Required quantity

2

replacement in pairs recommended



**References**

Audi 7L0 412 333 A

Volkswagen 7L0 412 333 A

Porsche 955 343 243 01

**Application info**

Audi Q7 I (4L\_) (03/06-01/16)

Porsche Cayenne II (92A) (06/10--)

Volkswagen Touareg II (7P5 ) (01/10-12/18)

Porsche Cayenne I (955) (09/02-12/10)

Volkswagen Touareg I (7LA, 7L6 ,7L7 ) (10/02-01/13)

**Mount, control arm**

100 610 0014/HD

MCM0014HD

**Notes**

Carbon Neutral  
 Front Axle Left  
 Front Axle Right  
 Rear  
 with holder  
 with rubber mount

Height [mm]

50

Inner Diameter [mm]

19

Replace in pairs only

Required quantity

2

reinforced version



**References**

Audi 3C0 199 231 D

Audi 3C0 199 231 F

Seat 3C0 199 231 E

Volkswagen 3C0 199 231 A

Volkswagen 3C0 199 231 D

Volkswagen 3C0 199 231 F

Audi 3C0 199 231 E

Seat 3C0 199 231 D

Seat 3C0 199 231 F

Volkswagen 3C0 199 231 B

Volkswagen 3C0 199 231 E

Volkswagen (FAW) 3C0 199 231 D

**Application info**

Audi Q3 I (8U\_) (06/11-12/18)

Volkswagen CC (11/11-12/16)

Volkswagen Passat (3C\_) (03/05-01/12)

Volkswagen Tiguan I (5N ) (09/07-07/18)

Seat Alhambra II (710) (06/10--)

Volkswagen Passat (362, 365) (08/10-12/15)

Volkswagen Sharan (7N) (05/10--)

**Mount, control arm****100 610 0018/HD****MCB0103HD****Notes**

Carbon Neutral  
 Front Axle Left  
 Front Axle Right  
 Lower  
 Rear  
 without holder

Height [mm] 80  
 Inner Diameter [mm] 12  
 Outer Diameter [mm] 75  
 Replace in pairs only  
 Required quantity 2  
 reinforced version

**References**

Audi 4E0 407 183 A	Audi 4E0 407 183 B
Audi 4E0 407 183 H	Audi 4G0 407 183
Audi 4G0 407 183 A	Audi 4G0 407 183 B
Audi 4H0 407 183	Audi 4H0 407 183 B
Audi 4H0 407 183 C	Audi (FAW) 4G0 407 183 B
Volkswagen 4E0 407 183 A	Volkswagen 4E0 407 183 B
Volkswagen 4E0 407 183 H	Volkswagen (SVW) 4G0 407 183 C

**Application info**

Audi A4 IV (8K_) (08/07-05/16)	Audi A5 I (8F_ , 8T_) (06/07-01/17)
Audi A6 IV (4G2, 4G5, C7) (11/10-09/18)	Audi A7 I Sportback (4G_) (07/10-05/18)
Audi A8 II (4E_) (10/02-12/10)	Audi A8 III (4H_) (11/09-01/18)
Audi Q5 I (8R_) (11/08-12/17)	Volkswagen Phaeton (3D) (04/02-03/16)

**Mount, control arm****100 610 0020****MCB0104****Notes**

Front Axle Left  
 Front Axle Right  
 inner  
 without holder

Height [mm] 75  
 Inner Diameter [mm] 25  
 Outer Diameter [mm] 52  
 Required quantity 2  
 replacement in pairs recommended





**References**

Mercedes-Benz 906 333 00 14  
 Mercedes-Benz A 906 333 00 14  
 Volkswagen 2E0 407 523

Mercedes-Benz 906 333 01 14  
 Mercedes-Benz A 906 333 01 14  
 Volkswagen 2E0 407 523 A

**Application info**

Mercedes-Benz BM 906 (Sprinter II) (06/06--)  
 Volkswagen Crafter I (2E) (04/06-12/16)

Mercedes-Benz BM 907 / 910 (Sprinter III) (02/18--)

**Mount, control arm****100 610 0021****MCB0105****Notes**

Front  
 Front Axle Left  
 Front Axle Right  
 Lower  
 inner  
 without holder

Height [mm] 55  
 Inner Diameter [mm] 12  
 Outer Diameter [mm] 50  
 Required quantity 2  
 replacement in pairs recommended

**References**

Audi 8K0 407 182 A  
 Audi 8K0 407 182 C  
 Audi (FAW) 8K0 407 182 C  
 Porsche 8K0 407 182 B

Audi 8K0 407 182 B  
 Audi (FAW) 8K0 407 182 B  
 Audi (FAW) L8K0 407 182 B  
 Volkswagen (SVW) 8K0 407 182 B

**Application info**

Audi A4 IV (8K\_) (08/07-05/16)  
 Audi A5 I (8F\_, 8T\_) (06/07-01/17)  
 Audi A6 IV (4G2, 4G5, C7) (11/10-09/18)  
 Audi Q5 I (8R\_) (11/08-12/17)

Audi A4 V (8W\_) (05/15--)  
 Audi A5 II (F5\_) (06/16--)  
 Audi A7 I Sportback (4G\_) (07/10-05/18)  
 Porsche Macan (95B) (02/14--)

## Mount, control arm

100 610 0027/HD

MCB0108HD

## Notes

Carbon Neutral  
 Front Axle Left  
 Front Axle Right  
 Rear  
 without holder

Height [mm]

50

Inner Diameter [mm]

19

Outer Diameter [mm]

63

Replace in pairs only

Required quantity

2

reinforced version



## References

Audi 1K0 199 231 G

Audi 1K0 199 231 K

Audi 1K0 199 232 J

Seat 1K0 199 231 J

Seat 1K0 199 232 J

Seat 1K0 407 183 E

Seat 6Q0 407 183 A

Skoda 1K0 199 231 J

Skoda 1K0 407 183 E

Skoda 6Q0 407 183 A

Skoda (SVW) 1K0 199 231 J

Skoda (SVW) 1KD 199 231

Volkswagen 1K0 199 231 J

Volkswagen 1K0 199 232 G

Volkswagen 1K0 199 232 K

Volkswagen 1K0 407 183 E

Volkswagen 3C0 199 231 F

Volkswagen 6Q0 407 183 A

Volkswagen (FAW) 1K0 199 231

Volkswagen (FAW) 1KD 199 231

Audi 1K0 199 231 J

Audi 1K0 199 232 G

Audi 1K0 199 232 K

Seat 1K0 199 231 K

Seat 1K0 199 232 K

Seat 6Q0 407 183

Seat 6Q0 407 183 B

Skoda 1K0 199 232 J

Skoda 6Q0 407 183

Skoda 6Q0 407 183 B

Skoda (SVW) 1K0 199 232 J

Volkswagen 1K0 199 231 G

Volkswagen 1K0 199 231 K

Volkswagen 1K0 199 232 J

Volkswagen 1K0 407 183

Volkswagen 3C0 199 231 E

Volkswagen 6Q0 407 183

Volkswagen 6Q0 407 183 B

Volkswagen (FAW) 1K0 199 232

**Application info**

Audi A3 II (8P_) (05/03-12/15)	Audi A3 III (8V_) (04/12--)
Audi Q3 I (8U_) (06/11-12/18)	Seat Alhambra II (710) (06/10--)
Seat Ibiza III / Cordoba II (6L_) (02/02-11/09)	Seat Leon II / Toledo III / Altea (1P_ ,5P_) (03/04--)
Skoda Fabia I (6Y_) (08/99-03/08)	Skoda Fabia II (54_) (12/06-12/14)
Skoda Octavia II (1Z_) (02/04-06/13)	Skoda Roomster (03/06-05/15)
Skoda Superb II (3T) (03/08-05/15)	Skoda Yeti (5L) (05/09-12/17)
Volkswagen Beetle (5C1) (04/11-07/19)	Volkswagen Bora V (Mex) (01/07--)
Volkswagen CC (11/11-12/16)	Volkswagen Caddy III (2KA, 2KB) (03/04-05/15)
Volkswagen Eos (03/06-08/15)	Volkswagen Fox/Lupo (Z51) (08/03--)
Volkswagen Golf V (1K1, 1K5, 5M1) (10/03-08/14)	Volkswagen Golf VI (5K1, 517, AJ5) (10/08-05/16)
Volkswagen Jetta III (1K2) (09/04-12/13)	Volkswagen Passat (362, 365) (08/10-12/15)
Volkswagen Passat (3C_) (03/05-01/12)	Volkswagen Polo (9N_) (10/01--)
Volkswagen Scirocco III (137) (05/08-11/17)	Volkswagen Sharan (7N) (05/10--)
Volkswagen Tiguan I (5N) (09/07-07/18)	Volkswagen Touran I (1T1/2/3) (02/03-05/15)

**Mount, control arm****100 610 0028****MCM0016****Notes**

Front Axle Left  
 Front Axle Right  
 with holder



Height [mm]	50
Inner Diameter [mm]	19
Required quantity	2
replacement in pairs recommended	



**References**

Audi 8J0 199 231

**Application info**

Audi TT II (8J\_) (07/06-01/15)

Mount, control arm		100 610 0030	MCB0401
<b>Notes</b>  Front Axle Left Front Axle Right Lower outer without holder  Height [mm] 84 Inner Diameter [mm] 14.4 Outer Diameter [mm] 46.5 Required quantity 2 replacement in pairs recommended			
<b>References</b> Volkswagen 2H0 412 333 A			
<b>Application info</b> Volkswagen Amarok I (09/10-- )			
Mount, control arm		100 610 0032	MCB0393
<b>Notes</b>  Front Axle Left Front Axle Right Lower Rear inner without holder  Height [mm] 64 Inner Diameter [mm] 14.4 Outer Diameter [mm] 60.5 Required quantity 2 replacement in pairs recommended			
<b>References</b> Volkswagen 2H0 407 182 A			
<b>Application info</b> Volkswagen Amarok I (09/10-- )			

Mount, control arm		100 610 0033	MCB0394
<b>Notes</b>  Front Axle Left Front Axle Right Upper without holder  Height [mm] 60 Inner Diameter [mm] 10 Outer Diameter [mm] 40.5 Required quantity 2 replacement in pairs recommended			
<b>References</b> Volkswagen 2H0 407 077 A			
<b>Application info</b> Volkswagen Amarok I (09/10--)			
Mount, control arm		100 610 0034	MCB0109
<b>Notes</b>  Front Axle Left Front Axle Right Rear without holder  Height [mm] 50 Inner Diameter [mm] 14 Outer Diameter [mm] 64 Required quantity 2 replacement in pairs recommended			
<b>References</b> Skoda 1K0 407 183 M Skoda 5C0 407 183 A Volkswagen 1K0 407 183 P Volkswagen (SVW) 1K0 407 183 P Skoda 1K0 407 183 P Volkswagen 1K0 407 183 M Volkswagen 5C0 407 183 A			
<b>Application info</b> Skoda Superb II (3T) (03/08-05/15) Volkswagen Beetle (5C1) (04/11-07/19) Volkswagen Caddy IV (SA_) (05/15--) Volkswagen Passat (A32) (01/11--) Skoda Yeti (5L) (05/09-12/17) Volkswagen Caddy III (2KA, 2KB) (03/04-05/15) Volkswagen Jetta IV (162) (01/08--)			

## Mount, control arm

100 610 0036

MCB0389

## Notes

Front Axle Left  
 Front Axle Right  
 Rear  
 without holder

Height [mm] 50  
 Inner Diameter [mm] 13  
 Outer Diameter [mm] 65  
 Required quantity 2  
 replacement in pairs recommended



## References

Audi 5Q0 407 183 E	Audi 5Q0 407 183 L
Audi (FAW) 5Q0 407 183 E	Seat 5Q0 407 183 E
Seat 5Q0 407 183 J	Seat 5Q0 407 183 K
Seat 5Q0 407 183 L	Skoda 5Q0 407 183 E
Skoda 5Q0 407 183 G	Skoda 5Q0 407 183 J
Skoda 5Q0 407 183 K	Skoda 5Q0 407 183 L
Skoda 5Q0 407 183 M	Volkswagen 5Q0 407 183 D
Volkswagen 5Q0 407 183 E	Volkswagen 5Q0 407 183 G
Volkswagen 5Q0 407 183 J	Volkswagen 5Q0 407 183 K
Volkswagen 5Q0 407 183 L	Volkswagen 5Q0 407 183 M
Volkswagen (FAW) 5Q0 407 183 E	Volkswagen (SVW) 5Q0 407 183 E
Volkswagen (SVW) 5Q0 407 183 K	

## Application info

Audi A1 II (GB_) (07/18--)	Audi A3 III (8V_) (04/12--)
Audi A3 IV (8Y_) (11/19--)	Audi Q2 (06/16--)
Audi Q3 II (F3_) (07/18--)	CUPRA FORMENTOR (KM_) (07/20--)
Seat Arona (KJ7) (07/17--)	Seat Ateca (04/16--)
Seat Ibiza V (KJ1) (01/17--)	Seat Leon III (5F_) (09/12--)
Seat Tarraco (09/18--)	Skoda Kamiq (07/19--)
Skoda Karoq (07/17--)	Skoda Kodiaq I (10/16--)
Skoda Kodiaq II (01/24--)	Skoda Octavia III (5E_) (11/12--)
Skoda Octavia IV (NX_) (11/19--)	Skoda Scala (02/19--)
Skoda Superb III (3V_) (03/15--)	Skoda Superb IV (NZ_) (11/23--)
Volkswagen Arteon (03/17--)	Volkswagen Golf VII (5G1,BA5) (08/12--)
Volkswagen Golf VIII (CB1) (07/19--)	Volkswagen Jetta VII (BU3) (12/17--)
Volkswagen Nivus / Taigo (11/21--)	Volkswagen Passat (B8) (08/14--)
Volkswagen Polo (AW1) (06/17--)	Volkswagen T-Cross (12/18--)
Volkswagen T-Roc (A11) (07/17--)	Volkswagen Taos (CL1, CQ1) (10/20--)
Volkswagen Tiguan II (AD1, BW2) (01/16--)	Volkswagen Touran II (5T1) (05/15--)

**Mount, control arm****100 610 0038/HD****MCB0390HD****Notes**

Carbon Neutral  
 Front Axle Left  
 Front Axle Right  
 without holder

Height [mm] 80  
 Inner Diameter [mm] 12  
 Outer Diameter [mm] 75  
 Replace in pairs only  
 Required quantity 2  
 reinforced version

**References**

Audi 8K0 407 183 D  
 Audi 8K0 407 183 G  
 Audi (FAW) 8K0 407 183 F

Audi 8K0 407 183 F  
 Audi (FAW) 8K0 407 183 D  
 Porsche 8K0 407 183 D

**Application info**

Audi A4 IV (8K\_) (08/07-05/16)  
 Audi A5 I (8F\_, 8T\_) (06/07-01/17)  
 Audi Q5 I (8R\_) (11/08-12/17)

Audi A4 V (8W\_) (05/15--)  
 Audi A5 II (F5\_) (06/16--)  
 Porsche Macan (95B) (02/14--)

**Mount, control arm****100 610 0039/HD****MCB0426HD****Notes**

Carbon Neutral  
 Front Axle Left  
 Front Axle Right  
 without holder

Height [mm] 90  
 Inner Diameter [mm] 12  
 Outer Diameter [mm] 75  
 Replace in pairs only  
 Required quantity 2  
 reinforced version

**References**

Audi 4K0 407 183  
 Audi 80A 407 183

Audi 4K0 407 183 A

**Application info**

Audi A6 V (C8, 4A2) (02/18--)  
 Audi Q5 II (FY\_) (05/16--)

Audi A7 II Sportback (4K\_) (10/17--)

**Mount, control arm****100 610 0041****MCM0156****Notes**

Front Axle Left  
with holder  
with rubber mount

Height [mm] 50  
Inner Diameter [mm] 18  
Paired article number 100 610 0042 | MCM0157  
Required quantity 1  
replacement in pairs recommended

**References**

Audi 1K0 199 231 G  
Audi 1K0 199 231 K  
Seat 1K0 199 231 K  
Skoda (SVW) 1K0 199 231 J  
Volkswagen 1K0 199 231 J  
Volkswagen (FAW) 1K0 199 231

Audi 1K0 199 231 J  
Seat 1K0 199 231 J  
Skoda 1K0 199 231 J  
Volkswagen 1K0 199 231 G  
Volkswagen 1K0 199 231 K

**Application info**

Audi A3 II (8P\_) (05/03-12/15)  
Skoda Octavia II (1Z\_) (02/04-06/13)  
Skoda Yeti (5L) (05/09-12/17)  
Volkswagen Caddy III (2KA, 2KB) (03/04-05/15)  
Volkswagen Golf V (1K1, 1K5, 5M1) (10/03-08/14)  
Volkswagen Jetta III (1K2) (09/04-12/13)  
Volkswagen Touran I (1T1/2/3) (02/03-05/15)

Seat Leon II / Toledo III / Altea (1P\_ ,5P\_) (03/04--)  
Skoda Superb II (3T) (03/08-05/15)  
Volkswagen Beetle (5C1) (04/11-07/19)  
Volkswagen Eos (03/06-08/15)  
Volkswagen Golf VI (5K1, 517, AJ5) (10/08-05/16)  
Volkswagen Scirocco III (137) (05/08-11/17)

**Mount, control arm****100 610 0042****MCM0157****Notes**

Front Axle Right  
with holder  
with rubber mount

Height [mm] 50  
Inner Diameter [mm] 18  
Paired article number 100 610 0041 | MCM0156  
Required quantity 1  
replacement in pairs recommended





**References**

Audi 1K0 199 232 G

Audi 1K0 199 232 K

Seat 1K0 199 232 K

Skoda (SVW) 1K0 199 232 J

Volkswagen 1K0 199 232 J

Volkswagen (FAW) 1K0 199 232 J

Audi 1K0 199 232 J

Seat 1K0 199 232 J

Skoda 1K0 199 232 J

Volkswagen 1K0 199 232 G

Volkswagen 1K0 199 232 K

**Application info**

Audi A3 II (8P\_) (05/03-12/15)

Skoda Octavia II (1Z\_) (02/04-06/13)

Skoda Yeti (5L) (05/09-12/17)

Volkswagen Caddy III (2KA, 2KB) (03/04-05/15)

Volkswagen Golf V (1K1, 1K5, 5M1) (10/03-08/14)

Volkswagen Jetta III (1K2) (09/04-12/13)

Volkswagen Touran I (1T1/2/3) (02/03-05/15)

Seat Leon II / Toledo III / Altea (1P\_ ,5P\_) (03/04--)

Skoda Superb II (3T) (03/08-05/15)

Volkswagen Beetle (5C1) (04/11-07/19)

Volkswagen Eos (03/06-08/15)

Volkswagen Golf VI (5K1, 517, AJ5) (10/08-05/16)

Volkswagen Scirocco III (137) (05/08-11/17)

**Mount, control arm****100 610 0043****MCB0441****Notes**Front Axle Left  
Front Axle Right  
without holder

Height [mm]

50

Inner Diameter [mm]

19

Outer Diameter [mm]

63

Required quantity

2

replacement in pairs recommended



**References**

Audi 1K0 199 231 G	Audi 1K0 199 231 J
Audi 1K0 199 231 K	Audi 1K0 199 232 G
Audi 1K0 199 232 J	Audi 1K0 199 232 K
Seat 1K0 199 231 J	Seat 1K0 199 231 K
Seat 1K0 199 232 J	Seat 1K0 199 232 K
Seat 1K0 407 183 E	Seat 6Q0 407 183
Seat 6Q0 407 183 A	Skoda 1K0 199 231 J
Skoda 1K0 199 232 J	Skoda 1K0 407 183 E
Skoda 6Q0 407 183	Skoda 6Q0 407 183 A
Skoda (SVW) 1K0 199 231 J	Skoda (SVW) 1K0 199 232 J
Volkswagen 1K0 199 231 G	Volkswagen 1K0 199 231 J
Volkswagen 1K0 199 231 K	Volkswagen 1K0 199 232 G
Volkswagen 1K0 199 232 J	Volkswagen 1K0 199 232 K
Volkswagen 1K0 407 183	Volkswagen 1K0 407 183 E
Volkswagen 3C0 199 231 E	Volkswagen 3C0 199 231 F
Volkswagen 6Q0 407 183	Volkswagen 6Q0 407 183 A
Volkswagen 6Q0 407 183 B	Volkswagen (FAW) 1K0 199 231
Volkswagen (FAW) 1K0 199 232	

**Application info**

Audi A3 II (8P_) (05/03-12/15)	Seat Alhambra II (710) (06/10--)
Seat Ibiza III / Cordoba II (6L_) (02/02-11/09)	Seat Leon II / Toledo III / Altea (1P_ ,5P_) (03/04--)
Skoda Fabia I (6Y_) (08/99-03/08)	Skoda Fabia II (54_) (12/06-12/14)
Skoda Octavia II (1Z_) (02/04-06/13)	Skoda Roomster (03/06-05/15)
Skoda Superb II (3T) (03/08-05/15)	Skoda Yeti (5L) (05/09-12/17)
Volkswagen Beetle (5C1) (04/11-07/19)	Volkswagen Caddy III (2KA, 2KB) (03/04-05/15)
Volkswagen Eos (03/06-08/15)	Volkswagen Fox/Lupo (Z51) (08/03--)
Volkswagen Golf V (1K1, 1K5, 5M1) (10/03-08/14)	Volkswagen Golf VI (5K1, 517, AJ5) (10/08-05/16)
Volkswagen Jetta III (1K2) (09/04-12/13)	Volkswagen Passat (362, 365) (08/10-12/15)
Volkswagen Passat (3C_) (03/05-01/12)	Volkswagen Polo (9N_) (10/01--)
Volkswagen Scirocco III (137) (05/08-11/17)	Volkswagen Sharan (7N) (05/10--)
Volkswagen Tiguan I (5N) (09/07-07/18)	Volkswagen Touran I (1T1/2/3) (02/03-05/15)

**Mount, control arm**

100 610 0044

MCM0158

**Notes**

Front Axle Left  
Front Axle Right  
with holder  
with rubber mount

Height [mm] 50  
Inner Diameter [mm] 19  
Required quantity 2  
replacement in pairs recommended



**References**

Audi 3C0 199 231 D  
Seat 3C0 199 231 D  
Seat 3C0 199 231 F  
Volkswagen 3C0 199 231 B  
Volkswagen 3C0 199 231 E  
Volkswagen (FAW) 3C0 199 231 D

Audi 3C0 199 231 E  
Seat 3C0 199 231 E  
Volkswagen 3C0 199 231 A  
Volkswagen 3C0 199 231 D  
Volkswagen 3C0 199 231 F

**Application info**

Audi Q3 I (8U\_) (06/11-12/18)  
Volkswagen CC (11/11-12/16)  
Volkswagen Passat (3C\_) (03/05-01/12)  
Volkswagen Tiguan I (5N) (09/07-07/18)

Seat Alhambra II (710) (06/10--)  
Volkswagen Passat (362, 365) (08/10-12/15)  
Volkswagen Sharan (7N) (05/10--)

**Mount, control arm**

100 610 0049

MCB0525

**Notes**

Front  
Front Axle Left  
Front Axle Right  
Rubber/Metal  
inner  
without holder

Height [mm] 55  
Inner Diameter [mm] 12.1  
Outer Diameter [mm] 55.4  
Required quantity 2  
replacement in pairs recommended



**References**

Audi 4H0 407 182 B

Audi 4H0 407 182 C

**Application info**

Audi A8 III (4H\_) (11/09-01/18)

**Mount, control arm**

100 610 0050

MCB0503

**Notes**

Front Axle Left  
 Front Axle Right  
 Upper  
 without holder

Height [mm] 50  
 Inner Diameter [mm] 10  
 Outer Diameter [mm] 46  
 Required quantity 2  
 replacement in pairs recommended



**References**

Audi 4N0 407 515

Audi 8W0 407 515

Audi (FAW) 8W0 407 515

**Application info**

Audi A4 V (8W\_) (05/15--)

Audi A5 II (F5\_) (06/16--)

Audi A8 IV (4N\_) (06/17--)

**Mount, control arm**

100 610 0051/HD

MCB0491HD

**Notes**

Carbon Neutral  
 Front  
 Front Axle Left  
 Front Axle Right  
 Lower  
 outer  
 without holder

Height [mm] 45  
 Inner Diameter [mm] 12  
 Outer Diameter [mm] 44  
 Replace in pairs only  
 Required quantity 2  
 reinforced version



**References**

Audi 80A 407 181

**Application info**

Audi A4 V (8W\_) (05/15--)  
 Audi A6 V (C8, 4A2) (02/18--)  
 Audi Q5 II (FY\_) (05/16--)

Audi A5 II (F5\_) (06/16--)  
 Audi A7 II Sportback (4K\_) (10/17--)

**Mount, control arm**

100 610 0054/HD

MCB0492HD

**Notes**

Carbon Neutral  
 Front Axle Left  
 Front Axle Right  
 Rear  
 without holder

Height [mm] 70  
 Inner Diameter [mm] 16  
 Outer Diameter [mm] 70.5  
 Quantity per axle 2  
 Replace in pairs only  
 Required quantity 2



**References**

MAN 65.43316.0004  
 Volkswagen 2N0 407 182 B  
 Volkswagen 2N0 407 182 D

MAN 65.43316.0007  
 Volkswagen 2N0 407 182 C

**Application info**

MAN TGE (11/16--)

Volkswagen Crafter II (SY\_) (09/16--)

**Mount, control arm**

100 610 0055

MCB0482

**Notes**

Front  
 Front Axle Left  
 Front Axle Right  
 without holder

Height [mm] 70  
 Inner Diameter [mm] 16  
 Outer Diameter [mm] 50  
 Required quantity 2  
 replacement in pairs recommended



**References**

MAN 65.43316.0005  
 Volkswagen 2N0 407 183 B

Volkswagen 2N0 407 183 A

**Application info**

MAN TGE (11/16--)

Volkswagen Crafter II (SY\_) (09/16--)

**Mount, control arm****100 610 0070****MCB0567****Notes**

Front Axle Left  
 Front Axle Right  
 Lower  
 Rear  
 without holder

Height [mm] 50  
 Inner Diameter [mm] 13.1  
 Outer Diameter [mm] 60  
 Required quantity 2  
 replacement in pairs recommended

**References**

Audi 2Q0 407 183  
 Seat 2Q0 407 183  
 Skoda 2Q0 407 183  
 Volkswagen 2Q0 407 183

Audi 2Q0 407 183 B  
 Seat 2Q0 407 183 B  
 Skoda 2Q0 407 183 B  
 Volkswagen 2Q0 407 183 B

**Application info**

Audi A1 II (GB\_) (07/18--)  
 Seat Ibiza V (KJ1) (01/17--)  
 Skoda Kamiq (07/19--)  
 Volkswagen Polo (AW1) (06/17--)

Seat Arona (KJ7) (07/17--)  
 Skoda Fabia IV (PJ3) (06/21--)  
 Skoda Scala (02/19--)  
 Volkswagen T-Cross (12/18--)

**Mount, control arm****100 610 0087****MCB0534****Notes**

Rear Axle Left  
 Rear Axle Right  
 Rubber/Metal  
 outer  
 without holder

Height [mm] 42  
 Inner Diameter [mm] 12.5  
 Outer Diameter [mm] 45.5  
 Quantity per axle 2  
 Required quantity 2  
 replacement in pairs recommended



**References**

Audi 4M0 505 291 D  
 Audi 4M0 505 541 K  
 Audi 80A 505 292  
 Audi 8W0 505 397 E  
 Audi 8W0 505 398 C  
 Audi 8W0 505 398 F

Audi 4M0 505 292 D  
 Audi 80A 505 291  
 Audi 8W0 505 397 C  
 Audi 8W0 505 397 F  
 Audi 8W0 505 398 E

**Application info**

Audi A4 V (8W\_) (05/15--)  
 Audi Q5 II (FY\_) (05/16--)

Audi A5 II (F5\_) (06/16--)  
 Audi Q7 II (4M\_) (01/15--)

**Mount, control arm****100 610 0088****MCB0572****Notes**

Rear Axle Left  
 Rear Axle Right  
 Rubber/Metal  
 inner  
 without holder

Height [mm] 42  
 Inner Diameter [mm] 10  
 Outer Diameter [mm] 40  
 Quantity per axle 2  
 Required quantity 2  
 replacement in pairs recommended

**References**

Audi 4M0 505 291 D  
 Audi 4M0 505 323 G  
 Audi 8W0 505 323 F  
 Audi (FAW) 8W0 505 323 F  
 Volkswagen 4M0 505 323 G

Audi 4M0 505 292 D  
 Audi 4M0 505 543 A  
 Audi 8W0 505 324 F  
 Audi (FAW) 8W0 505 324 F

**Application info**

Audi A4 V (8W\_) (05/15--)  
 Audi A6 V (C8, 4A2) (02/18--)  
 Audi E-TRON (GE\_) (09/18--)  
 Audi Q7 II (4M\_) (01/15--)  
 Volkswagen Touareg III (CR7) (11/17--)

Audi A5 II (F5\_) (06/16--)  
 Audi A7 II Sportback (4K\_) (10/17--)  
 Audi Q5 II (FY\_) (05/16--)  
 Audi Q8 (4MN) (02/18--)

**Mount, control arm****100 710 0035****MCB0395****Notes**Rear Axle Left  
Rear Axle Right  
without holderHeight [mm] 70  
Inner Diameter [mm] 14  
Outer Diameter [mm] 60.5  
Required quantity 2  
replacement in pairs recommended**References**Audi 7L0 505 311 B  
Porsche 955 331 017 11  
Volkswagen 7P0 505 311 EAudi 7L0 505 312 B  
Volkswagen 7L0 505 311 B**Application info**Audi Q7 I (4L\_) (03/06-01/16)  
Volkswagen Touareg I (7LA, 7L6 ,7L7 ) (10/02-01/13)Porsche Cayenne I (955) (09/02-12/10)  
Volkswagen Touareg II (7P5 ) (01/10-12/18)**Mount, control arm****100 710 0052****MCB0527****Notes**Rear Axle Left  
Rear Axle Right  
inner  
without holderHeight [mm] 60  
Inner Diameter [mm] 12  
Outer Diameter [mm] 40  
Required quantity 2  
replacement in pairs recommended**References**Audi 1K0 501 529 F  
Seat 1K0 501 529 F  
Seat 7N0 501 530  
Volkswagen 1K0 501 529 E  
Volkswagen 1K0 501 530 CAudi (FAW) 1K0 501 529 F  
Seat 7N0 501 529  
Skoda 1K0 501 529 F  
Volkswagen 1K0 501 529 F  
Volkswagen 7N0 501 529



**Application info**

- |  |   |
|--|---|
| Audi A3 II (8P_) (05/03-12/15)                         | Audi Q3 I (8U_) (06/11-12/18)                   |
| Audi TT II (8J_) (07/06-01/15)                         | Seat Alhambra II (710) (06/10--)                |
| Seat Leon II / Toledo III / Altea (1P_ ,5P_) (03/04--) | Skoda Octavia II (1Z_) (02/04-06/13)            |
| Skoda Superb II (3T) (03/08-05/15)                     | Volkswagen CC (11/11-12/16)                     |
| Volkswagen Eos (03/06-08/15)                           | Volkswagen Golf V (1K1, 1K5, 5M1) (10/03-08/14) |
| Volkswagen Jetta III (1K2) (09/04-12/13)               | Volkswagen Passat (362, 365) (08/10-12/15)      |
| Volkswagen Passat (3C_) (03/05-01/12)                  | Volkswagen Passat (A32) (01/11--)               |
| Volkswagen Sharan (7N) (05/10--)                       | Volkswagen Tiguan I (5N ) (09/07-07/18)         |
| Volkswagen Touran I ( 1T1/2/3) (02/03-05/15)           |   |

**Mount, control arm**

100 710 0054

MCB0573

**Notes**

Lower  
Rear Axle  
outer  
without holder

- Height [mm] 42.2  
 Inner Diameter [mm] 12.1  
 Outer Diameter [mm] 45  
 Required quantity 2  
 replacement in pairs recommended



**References**

- |                          |                          |
|--------------------------|--------------------------|
| Audi 4M0 505 291 F       | Audi 4M0 505 292 F       |
| Audi (FAW) 4M0 505 291 F | Audi (FAW) 4M0 505 292 F |

**Application info**

- |                               |                                      |
|-------------------------------|--------------------------------------|
| Audi A6 V (C8, 4A2) (02/18--) | Audi A7 II Sportback (4K_) (10/17--) |
| Audi E-TRON (GE_) (09/18--)   | Audi Q5 II (FY_) (05/16--)           |
| Audi Q7 II (4M_) (01/15--)    | Audi Q8 (4MN) (02/18--)              |

**Mount, control arm**

100 710 0055

MCB0535

**Notes**

Rear Axle Left  
Rear Axle Right  
Rubber/Metal  
inner  
without holder

Height [mm]

45.8

Inner Diameter [mm]

12.1

Outer Diameter [mm]

42.2

Required quantity

2

replacement in pairs recommended

**References**

Audi 8W0 505 397 C

Audi 8W0 505 397 E

Audi 8W0 505 397 F

Audi 8W0 505 398 C

Audi 8W0 505 398 E

Audi 8W0 505 398 F

**Application info**

Audi A4 V (8W\_) (05/15--)

Audi A5 II (F5\_) (06/16--)

**Mount, control arm**

100 711 0017

MCB0112

**Notes**

Rear  
Rear Axle  
Upper  
inner  
without holder

Height [mm]

46

Inner Diameter [mm]

12

Outer Diameter [mm]

36

Required quantity

4

replacement in pairs recommended

**References**

Audi 8E0 501 541 K

Audi (FAW) 8E0 501 541 K

**Application info**

Audi A6 III (4F2, 4FH, 4F5) (04/04-08/11)

**Mount, control arm**

11-14 035 2320

MCB0113

**Notes**

Front Axle Left  
 Front Axle Right  
 Lower  
 inner  
 without holder

Height [mm]

34

Inner Diameter [mm]

10

Outer Diameter [mm]

28

Required quantity

2

replacement in pairs recommended

**References**

Citroën 3523.20

Citroën 3523.73

Peugeot 3523.20

Peugeot 3523.73

**Application info**

Citroën C15 / Visa (09/78-10/06)

Peugeot 205 (02/83-12/00)

**Mount, control arm**

11-14 352 0005

MCB0118

**Notes**

Front Axle Left  
 Front Axle Right  
 Lower  
 outer  
 without holder

Height [mm]

26

Inner Diameter [mm]

12

Outer Diameter [mm]

36

Required quantity

2

replacement in pairs recommended

**References**

Citroën 3523.49

Citroën 91 515 653

Peugeot 3523.25

Peugeot 3523.27

Peugeot 3523.29

Peugeot 3523.35

Peugeot 3523.49

Peugeot 3523.58

**Application info**

Citroën C15 / Visa (09/78-10/06)

Peugeot 205 (02/83-12/00)

Peugeot 309 (10/85-12/93)

**Mount, control arm**

11-14 610 0012/HD

MCM0025HD

**Notes**

Carbon Neutral  
 Front Axle Left  
 Front Axle Right  
 Lower  
 Rear  
 with holder

Height [mm] 38  
 Inner Diameter [mm] 19  
 Replace in pairs only  
 Required quantity 2  
 Thread Size M8x1.25  
 reinforced version



**References**

Citroën 3523.75  
 Peugeot 3520 H5  
 Peugeot 3523.75

Peugeot 1215144  
 Peugeot 3521 E5

**Application info**

Citroën Berlingo I (07/96-12/11)  
 Citroën Xsara Picasso (09/99-06/12)  
 Peugeot 306 (01/93-10/03)  
 Peugeot Partner II (04/08--)

Citroën Xsara (04/97-03/10)  
 Citroën ZX (03/91-07/99)  
 Peugeot Partner I (05/96--)

**Mount, control arm**

11-14 610 0013/HD

MCB0126HD

**Notes**

Carbon Neutral  
 Front Axle Left  
 Front Axle Right  
 Lower  
 Rear  
 without holder

Height [mm] 48  
 Inner Diameter [mm] 14  
 Outer Diameter [mm] 55  
 Replace in pairs only  
 Required quantity 2  
 reinforced version



**References**

CITROËN (DF-PSA) 3523.92  
 DS 3523 92  
 Peugeot (DF-PSA) 3523.92

Citroën 3523.92  
 Peugeot 3523.92

**Application info**

Citroën Berlingo II (04/08--)  
 Citroën C4 I / Coupe / Grand Picasso / Picasso / Stufenheck  
 (11/04--)  
 Citroën DS5 (09/11-07/15)  
 Peugeot 3008 I (05/09-12/17)  
 Peugeot 308 I (09/07--)  
 Peugeot 5008 I (06/09-03/17)  
 Peugeot RCZ (03/10-12/15)

Citroën C4 Grand Picasso II (01/13--)  
 Citroën C4 II / DS4 (02/09--)  
 DS DS 5 (04/15-12/18)  
 Peugeot 307 (08/00-12/12)  
 Peugeot 308 II (09/13--)  
 Peugeot Partner II (04/08--)

**Mount, control arm****11-14 610 0014/HD****MCM0026HD****Notes**

Carbon Neutral  
 Front Axle Left  
 Front Axle Right  
 Lower  
 Rear  
 with holder  
 Height [mm] 45  
 Inner Diameter [mm] 18  
 Replace in pairs only  
 Required quantity 2  
 Thread Size M12x175

Height [mm]  
 Inner Diameter [mm]  
 Replace in pairs only  
 Required quantity  
 Thread Size  
 reinforced version

**References**

Peugeot 3523.42  
 Peugeot 3523.89

Peugeot 3523.54

**Application info**

Peugeot 405 (01/87-12/99)

**Mount, control arm**

11-14 610 0015/HD

MCB0127HD

**Notes**

Carbon Neutral  
 Front  
 Front Axle Left  
 Front Axle Right  
 Lower  
 without holder

Height [mm] 31  
 Inner Diameter [mm] 12  
 Outer Diameter [mm] 33  
 Replace in pairs only  
 Required quantity 2  
 reinforced version

**References**

Citroën 96 110 483  
 Peugeot 1215145

Citroën 96 111 043

**Application info**

Citroën Berlingo I (07/96-12/11)  
 Citroën Xsara Picasso (09/99-06/12)  
 Peugeot 306 (01/93-10/03)  
 Peugeot Partner II (04/08--)

Citroën Xsara (04/97-03/10)  
 Citroën ZX (03/91-07/99)  
 Peugeot Partner I (05/96--)

**Mount, control arm**

11-14 610 0016/HD

MCB0128HD

**Notes**

Carbon Neutral  
 Front  
 Front Axle Left  
 Front Axle Right  
 Lower  
 without holder

Height [mm] 56  
 Inner Diameter [mm] 14  
 Outer Diameter [mm] 56  
 Replace in pairs only  
 Required quantity 2  
 reinforced version



**References**

CITROËN (DF-PSA) 3523.91  
 Citroën 3523.CW  
 DS 3523.CW  
 Peugeot 3523.AJ  
 Peugeot (DF-PSA) 3523.91

Citroën 3523.91  
 DS 3523 91  
 Peugeot 3523.91  
 Peugeot 3523.CW

**Application info**

Citroën Berlingo II (04/08--)  
 Citroën C4 I / Coupe / Grand Picasso / Picasso / Stufenheck  
 (11/04--)  
 Citroën DS5 (09/11-07/15)  
 DS DS 5 (04/15-12/18)  
 Peugeot 307 (08/00-12/12)  
 Peugeot 308 II (09/13--)  
 Peugeot Partner II (04/08--)

Citroën C4 Grand Picasso II (01/13--)  
 Citroën C4 II / DS4 (02/09--)  
 DS DS 4 I (07/15-12/18)  
 Peugeot 3008 I (05/09-12/17)  
 Peugeot 308 I (09/07--)  
 Peugeot 5008 I (06/09-03/17)  
 Peugeot RCZ (03/10-12/15)

**Mount, control arm****11-14 610 0020****MCB0131****Notes**

Front Axle Left  
 Front Axle Right  
 Lower  
 Rear  
 without holder

Height [mm] 48  
 Inner Diameter [mm] 14  
 Outer Diameter [mm] 57  
 Required quantity 2  
 replacement in pairs recommended

**References**

Citroën 3523.CC  
 Citroën 98 105 881 80  
 DS 96 770 405 80  
 DS 98 105 882 80  
 Peugeot 96 770 405 80  
 Peugeot 98 105 882 80

Citroën 96 770 405 80  
 Citroën 98 105 882 80  
 DS 98 105 881 80  
 Peugeot 3523.CC  
 Peugeot 98 105 881 80

**Application info**

Citroën C Elyse (11/12--)  
 Citroën C3 III (07/16--)  
 Citroën C4 Cactus (09/14--)  
 DS DS 3 (04/15-07/19)  
 Peugeot 2008 I (03/13--)  
 Peugeot 208 I (03/12--)  
 Vauxhall Crossland X (03/17--)

Citroën C3 AIRCROSS II (06/17--)  
 Citroën C3 Picasso (02/09--)  
 Citroën DS3 (11/09-12/16)  
 Opel Crossland X (03/17--)  
 Peugeot 207 (02/06--)  
 Peugeot 301 (11/12--)  
 Vauxhall Grandland X (75) (06/17--)

**Mount, control arm****11-14 610 0021****MCB0132****Notes**

Front  
 Front Axle Left  
 Front Axle Right  
 Lower  
 without holder

Height [mm] 48  
 Inner Diameter [mm] 14  
 Outer Diameter [mm] 57  
 Required quantity 2  
 replacement in pairs recommended

**References**

Citroën 3523.CE  
 Citroën 98 105 881 80  
 DS 98 105 881 80  
 Peugeot 3523.CE  
 Peugeot 98 105 881 80

Citroën 96 770 410 80  
 Citroën 98 105 882 80  
 DS 98 105 882 80  
 Peugeot 96 770 410 80  
 Peugeot 98 105 882 80

**Application info**

Citroën C Elyse (11/12--)  
 Citroën C3 III (07/16--)  
 Citroën C4 Cactus (09/14--)  
 DS DS 3 (04/15-07/19)  
 Peugeot 2008 I (03/13--)  
 Peugeot 208 I (03/12--)

Citroën C3 AIRCROSS II (06/17--)  
 Citroën C3 Picasso (02/09--)  
 Citroën DS3 (11/09-12/16)  
 Opel Crossland X (03/17--)  
 Peugeot 207 (02/06--)  
 Peugeot 301 (11/12--)



**Mount, control arm**

11-14 610 0025

MCB0133

**Notes**

Front  
Front Axle Left  
Front Axle Right  
Lower  
without holder

Height [mm] 65  
Inner Diameter [mm] 18  
Outer Diameter [mm] 57  
Required quantity 2  
replacement in pairs recommended



**References**

Citroën 3520.S0	Citroën 3520.S1
Citroën 3521.P1	Citroën 3521.P2
Fiat 1352225080	Fiat 1352226080
Fiat 1352227080	Fiat 1352228080
Peugeot 3520.S0	Peugeot 3520.S1
Peugeot 3521.P1	Peugeot 3521.P2

**Application info**

Citroën Jumper III (04/06--)	Fiat Ducato (250) (07/06--)
Peugeot Boxer III (09/05--)	

**Mount, control arm**

11-14 610 0026

MCB0134

**Notes**

Front Axle Left  
Front Axle Right  
Lower  
Rear  
without holder

Height [mm] 76  
Inner Diameter [mm] 19  
Outer Diameter [mm] 73  
Required quantity 2  
replacement in pairs recommended



**References**

Citroën 3520.S0  
 Citroën 3521.P1  
 Fiat 1352225080  
 Fiat 1352227080  
 Peugeot 3520.S0  
 Peugeot 3521.P1

Citroën 3520.S1  
 Citroën 3521.P2  
 Fiat 1352226080  
 Fiat 1352228080  
 Peugeot 3520.S1  
 Peugeot 3521.P2

**Application info**

Citroën Jumper III (04/06--)  
 Peugeot Boxer III (09/05--)

Fiat Ducato (250) (07/06--)

**Mount, control arm****11-14 610 0032****MCM0030****Notes**

Front Axle Left  
 Front Axle Right  
 Lower  
 Rear  
 with holder  
 with rubber mount

Height [mm] 42  
 Inner Diameter [mm] 20  
 Required quantity 2  
 Thread Size M12x1,75  
 Thread Size M14x2  
 replacement in pairs recommended

**References**

Peugeot 3520.N6  
 Peugeot 3521.J6  
 Peugeot 9649591680

Peugeot 3520.S8  
 Peugeot 3521.P9

**Application info**

Peugeot 407 (02/04--)

Peugeot 508 I (11/10--)

**Mount, control arm****11-14 610 0034****MCM0031****Notes**

Front  
 Front Axle Left  
 Front Axle Right  
 with holder  
 with rubber mount

Height [mm]

50

Inner Diameter [mm]

23

Required quantity

2

Thread Size

M14x1,5

replacement in pairs recommended

**References**

Citroën 3520.R8

Fiat 1401239480

Fiat 1497407080

Lancia 1401239480

Peugeot 16 075 106 80

Peugeot 16 109 405 80

Peugeot 3520 S5

Peugeot 3520 W4

Peugeot 3520.R8

Peugeot 3521 S0

Peugeot 3521 T2

Citroën 3521.N9

Fiat 1401239580

Fiat 1497408080

Lancia 1401239580

Peugeot 16 075 107 80

Peugeot 16 109 406 80

Peugeot 3520 V8

Peugeot 3520 X0

Peugeot 3521 P6

Peugeot 3521 S7

Peugeot 3521.N9

**Application info**

Citroën C8 (06/02--)

Fiat Scudo II (270) (01/07--)

Lancia Phedra (09/02-11/10)

Peugeot Expert II (01/07--)

Citroën Jumpy II (01/07--)

Fiat Ulysse II (179) (08/02-06/11)

Peugeot 807 (06/02--)

**Mount, control arm****11-14 610 0037****MCB0436****Notes**

Front  
 Front Axle Left  
 Front Axle Right  
 Lower  
 without holder

Height [mm] 59.5  
 Inner Diameter [mm] 14  
 Outer Diameter [mm] 43  
 Required quantity 2  
 replacement in pairs recommended

**References**

Citroën 96 760 321 80  
 Citroën 98 168 655 80  
 Citroën 98 463 295 80  
 Peugeot 98 168 654 80  
 Peugeot 98 200 812 80  
 Peugeot 98 203 815 80  
 Peugeot 98 463 290 80  
 Peugeot 98 463 295 80

Citroën 98 168 654 80  
 Citroën 98 463 290 80  
 Peugeot 96 760 321 80  
 Peugeot 98 168 655 80  
 Peugeot 98 200 813 80  
 Peugeot 98 203 816 80  
 Peugeot 98 463 292 80  
 Peugeot 98 463 297 80

**Application info**

Citroën Berlingo III (06/18--)  
 Citroën C4 II / DS4 (02/09--)  
  
 Citroën C5 AIRCROSS (11/18--)  
 Opel Combo E (K9) (06/18--)  
 Peugeot 3008 II (05/16--)  
 Peugeot 308 II (09/13--)  
 Peugeot 5008 II (12/16--)  
 Peugeot Rifter (09/18--)  
 Vauxhall Grandland X (75) (06/17--)

Citroën C4 Grand Picasso II (01/13--)  
 Citroën C4 SPACETOURER / GRAND SPACETOURER  
 (04/18--)  
 Opel Astra L (10/21--)  
 Opel Grandland X (75) (06/17--)  
 Peugeot 308 I (09/07--)  
 Peugeot 308 III (07/21--)  
 Peugeot 508 II (09/18--)  
 Vauxhall Combo Mk IV (06/18--)

## Mount, control arm

11-14 610 0038

MCM0032

## Notes

Front Axle Left  
Rear  
with holder  
with rubber mount

Height [mm] 61.5  
Inner Diameter [mm] 23  
Paired article number 11-14 610 0039 | MCM0033  
Required quantity 1  
Thread Size M12x1,25  
replacement in pairs recommended



## References

Citroën 3520.P6	Citroën 3520.R8
Citroën 3521.H0	Fiat 1346384080
Fiat 1401239480	Fiat 1401239580
Fiat 1497408080	Fiat 93501487
Lancia 1346384080	Lancia 1401239480
Lancia 1401239580	Lancia 93501487
Peugeot 16 075 106 80	Peugeot 16 109 406 80
Peugeot 3520 S5	Peugeot 3520 V8
Peugeot 3520 W4	Peugeot 3520 X0
Peugeot 3520.P6	Peugeot 3520.R8
Peugeot 3521.H0	

## Application info

Citroën C8 (06/02--)	Citroën Jumpy II (01/07--)
Fiat Scudo II (270) (01/07--)	Fiat Ulysse II (179) (08/02-06/11)
Lancia Phedra (09/02-11/10)	Peugeot 807 (06/02--)
Peugeot Expert II (01/07--)	

## Mount, control arm

11-14 610 0039

MCM0033

## Notes

Front Axle Right  
Rear  
with holder  
with rubber mount

Height [mm] 61.5  
Inner Diameter [mm] 23  
Paired article number 11-14 610 0038 | MCM0032  
Required quantity 1  
Thread Size M12x1,25  
replacement in pairs recommended





## References

Citroën 3521.H1	Citroën 3521.K6
Citroën 3521.N9	Fiat 134 638 5080
Fiat 1497407080	Fiat 93501488
Lancia 1346385080	Lancia 93501488
Peugeot 16 075 107 80	Peugeot 16 109 405 80
Peugeot 3521 P6	Peugeot 3521 S0
Peugeot 3521 S7	Peugeot 3521 T2
Peugeot 3521.H1	Peugeot 3521.K6
Peugeot 3521.N9	

## Application info

Citroën C8 (06/02--)	Citroën Jumpy II (01/07--)
Fiat Scudo II (270) (01/07--)	Fiat Ulysse II (179) (08/02-06/11)
Lancia Phedra (09/02-11/10)	Peugeot 807 (06/02--)
Peugeot Expert II (01/07--)	

Mount, control arm		11-14 610 0040	MCM0034
<b>Notes</b>  Front Axle Left Front Axle Right Lower Rear with holder with rubber mount  Height [mm] 42 Inner Diameter [mm] 20 Required quantity 2 Thread Size M12x1,75 Thread Size M14x2 replacement in pairs recommended			
<b>References</b> Citroën 3520.S9 Citroën 3520.W1 Citroën 3520.W2 Citroën 3521.Q0 Citroën 3521.S4 Citroën 3521.S5			
<b>Application info</b> Citroën C5 III (RD_, TD_) (02/08--) Citroën C6 (09/05-12/12)			
Mount, control arm		11-14 610 0041	MCM0035
<b>Notes</b>  Front Axle Left Front Axle Right Lower Rear with holder with rubber mount  Height [mm] 42 Inner Diameter [mm] 20 Required quantity 2 Thread Size M12x1,75 Thread Size M14x2 replacement in pairs recommended			
<b>References</b> Citroën 3520.X6 Citroën 3521.T7			
<b>Application info</b> Citroën C5 III (RD_, TD_) (02/08--) Citroën C6 (09/05-12/12)			

**Mount, control arm**

11-14 610 0042

MCM0036

**Notes**

Front Axle Left  
 Front Axle Right  
 Lower  
 Rear  
 with holder  
 with rubber mount



Height [mm] 42  
 Inner Diameter [mm] 20  
 Required quantity 2  
 Thread Size M12x1,75  
 Thread Size M14x2  
 replacement in pairs recommended

**References**

Peugeot 3520.X7

Peugeot 3521.T8

**Application info**

Peugeot 407 (02/04--)

Peugeot 508 I (11/10--)

**Mount, control arm**

11-14 610 0043

MCB0349

**Notes**

Front  
 Front Axle Left  
 Front Axle Right  
 without holder



Height [mm] 48  
 Inner Diameter [mm] 18  
 Outer Diameter [mm] 55  
 Required quantity 2  
 replacement in pairs recommended

**References**

Citroën 3523 CZ

Citroën 3523 EA

Citroën 3523.CN

DS 3523 CZ

Peugeot 3523 CN

Peugeot 96 707 714 80

Peugeot 96 707 720 80

Peugeot 98 032 864 80

Peugeot 98 032 865 80



**Application info**

Citroën C2 / C3 I / Pluriel (02/02--)  
 Citroën C3 III (07/16--)  
 Citroën DS3 (11/09-12/16)  
 Peugeot 1007 (04/05--)  
 Peugeot 208 I (03/12--)

Citroën C3 II (09/09--)  
 Citroën C4 Cactus (09/14--)  
 DS DS 3 (04/15-07/19)  
 Peugeot 2008 I (03/13--)

**Mount, control arm**

11-14 610 0047/HD

MCM0166HD

**Notes**

Carbon Neutral  
 Front Axle Left  
 Front Axle Right  
 Lower  
 Rear  
 with holder

Height [mm] 61  
 Inner Diameter [mm] 21  
 Outer Diameter [mm] 70  
 Replace in pairs only  
 Required quantity 2  
 reinforced version



**References**

Peugeot 3520.Y0  
 Peugeot 96 77 547 880

Peugeot 3521.V1  
 Peugeot 96 77 548 980

**Application info**

Peugeot 508 I (11/10--)

**Mount, control arm**

11-14 610 0054

MCB0459

**Notes**

Front Axle Left  
 Front Axle Right  
 without holder

Height [mm] 65  
 Inner Diameter [mm] 14  
 Outer Diameter [mm] 52  
 Required quantity 2  
 replacement in pairs recommended



**References**

Citroën 96 76 035 280  
 Citroën 98 168 654 80  
 Citroën 98 463 290 80  
 Peugeot 96 76 035 280  
 Peugeot 98 168 654 80  
 Peugeot 98 200 812 80  
 Peugeot 98 203 815 80  
 Peugeot 98 463 290 80  
 Peugeot 98 463 295 80

Citroën 98 163 803 80  
 Citroën 98 168 655 80  
 Citroën 98 463 295 80  
 Peugeot 98 16 380 380  
 Peugeot 98 168 655 80  
 Peugeot 98 200 813 80  
 Peugeot 98 203 816 80  
 Peugeot 98 463 292 80  
 Peugeot 98 463 297 80

**Application info**

Citroën Berlingo III (06/18--)  
 Citroën C4 II / DS4 (02/09--)

Citroën C5 AIRCROSS (11/18--)  
 Opel Combo E (K9) (06/18--)  
 Peugeot 3008 II (05/16--)  
 Peugeot 308 II (09/13--)  
 Peugeot 5008 II (12/16--)  
 Peugeot Rifter (09/18--)  
 Vauxhall Grandland X (75) (06/17--)

Citroën C4 Grand Picasso II (01/13--)  
 Citroën C4 SPACETOURER / GRAND SPACETOURER  
 (04/18--)

Opel Astra L (10/21--)  
 Opel Grandland X (75) (06/17--)  
 Peugeot 308 I (09/07--)  
 Peugeot 308 III (07/21--)  
 Peugeot 508 II (09/18--)  
 Vauxhall Combo Mk IV (06/18--)

**Mount, control arm****11-14 610 0055/HD****MCB0463HD****Notes**

Carbon Neutral  
 Front Axle Left  
 Front Axle Right  
 Rear  
 without holder

Height [mm] 48  
 Inner Diameter [mm] 18  
 Outer Diameter [mm] 55  
 Replace in pairs only  
 Required quantity 2  
 reinforced version

**References**

Citroën 3523 EC  
 Citroën 3523.CP  
 Peugeot 3523.CR  
 Peugeot 96 707 720 80  
 Peugeot 98 032 865 80

Citroën 3523 EE  
 DS 3523 EC  
 Peugeot 96 707 714 80  
 Peugeot 98 032 864 80

**Application info**

Citroën C2 / C3 I / Pluriel (02/02--)

Citroën C3 III (07/16--)

Citroën DS3 (11/09-12/16)

Peugeot 1007 (04/05--)

Peugeot 208 I (03/12--)

Citroën C3 II (09/09--)

Citroën C4 Cactus (09/14--)

DS DS 3 (04/15-07/19)

Peugeot 2008 I (03/13--)

**Mount, control arm****114 610 0000****MCB0446****Notes**

Front Axle Left  
 Front Axle Right  
 Rear  
 inner  
 without holder

Height [mm]

50

Inner Diameter [mm]

13.5

Outer Diameter [mm]

66

Required quantity

2

replacement in pairs recommended

**References**

Audi 5Q0 407 183 F

Volkswagen 5Q0 407 183 F

Audi 81A 407 183

Volkswagen 81A 407 183

**Application info**

Audi A3 III (8V\_) (04/12--)

Audi Q2 (06/16--)

Audi TT III (8S\_) (07/14--)

Volkswagen Golf VIII (CB1) (07/19--)

Volkswagen Tiguan II (AD1, BW2) (01/16--)

Audi A3 IV (8Y\_) (11/19--)

Audi Q3 II (F3\_) (07/18--)

Volkswagen Golf VII (5G1,BA5) (08/12--)

Volkswagen T-Roc (A11) (07/17--)

**Mount, wheel bearing housing****016 010 6313****MCX0046****Notes**

Height [mm]

48

Inner Diameter [mm]

14

Outer Diameter [mm]

40

Required quantity

2

replacement in pairs recommended



**References**

Jaguar C2C12119

Jaguar C2C36866

Mercedes-Benz 201 352 00 27

Mercedes-Benz 211 350 18 06

Mercedes-Benz 220 352 02 27

Mercedes-Benz 221 352 01 27

Mercedes-Benz 231 333 02 27

Mercedes-Benz A 204 352 00 27

Mercedes-Benz A 220 352 00 27

Mercedes-Benz A 221 352 00 27

Mercedes-Benz A 230 352 00 27

Mercedes-Benz (BBDC) 204 352 00 27

Jaguar C2C18350

Jaguar C2D4013

Mercedes-Benz 204 352 00 27

Mercedes-Benz 220 352 00 27

Mercedes-Benz 221 352 00 27

Mercedes-Benz 230 352 00 27

Mercedes-Benz A 201 352 00 27

Mercedes-Benz A 211 350 18 06

Mercedes-Benz A 220 352 02 27

Mercedes-Benz A 221 352 01 27

Mercedes-Benz A 231 333 02 27

Mercedes-Benz (BBDC) A 204 352 00 27

**Application info**

Jaguar S-Type (CCX) (10/98-12/08)

Jaguar XJ (X351) (10/09--)

Mercedes-Benz BM 124 (12/84-12/93)

Mercedes-Benz BM 129 (SL) (03/89-09/04)

Mercedes-Benz BM 170 (SLK) (04/96-04/04)

Mercedes-Benz BM 172 (SLC) (01/16--)

Mercedes-Benz BM 201 (190) (10/82-08/93)

Mercedes-Benz BM 203 (C-Class) (05/00-06/11)

Mercedes-Benz BM 204 (GLK-Class) (06/08-12/15)

Mercedes-Benz BM 207 (E-Class) (01/09-12/16)

Mercedes-Benz BM 209 (CLK) (05/02-03/10)

Mercedes-Benz BM 211 (E-Class) (03/02-07/09)

Mercedes-Benz BM 213 (E-Class) (01/16--)

Mercedes-Benz BM 216 (S-Class) (05/06-12/13)

Mercedes-Benz BM 218 (CLS) (01/11-12/17)

Mercedes-Benz BM 220 (S-Class) (09/98-08/05)

Mercedes-Benz BM 222 (S-Class) (05/13--)

Mercedes-Benz BM 231 (SL) (01/12--)

Mercedes-Benz BM 253 (GLC) (06/15--)

Jaguar XF I (X250) (03/08--)

Jaguar XK (03/06-12/14)

Mercedes-Benz BM 124 (E-Class) (02/93-03/98)

Mercedes-Benz BM 140 (S-Class) (02/91-12/99)

Mercedes-Benz BM 171 (SLK) (03/04-12/11)

Mercedes-Benz BM 172 (SLK) (01/11--)

Mercedes-Benz BM 202 (C-Class) (03/93-03/01)

Mercedes-Benz BM 204 (C-Class) (01/07--)

Mercedes-Benz BM 205 (C-Class) (12/13--)

Mercedes-Benz BM 208 (CLK) (06/97-12/03)

Mercedes-Benz BM 210 (E-Class) (06/95-08/03)

Mercedes-Benz BM 212 (E-Class) (01/09-12/16)

Mercedes-Benz BM 215 (S-Class) (03/99-12/06)

Mercedes-Benz BM 217 (S-Class) (12/15--)

Mercedes-Benz BM 219 (CLS) (10/04-02/11)

Mercedes-Benz BM 221 (S-Class) (09/05-12/13)

Mercedes-Benz BM 230 (SL) (10/01-01/12)

Mercedes-Benz BM 238 (E-Class) (06/17--)

Mercedes-Benz BM 257 (CLS-Class) (12/17--)

**Mounting kit, control arm**

100 610 0000/HD

MCX0166HD

**Notes**

Carbon Neutral  
Front Axle Left  
Front Axle Right  
Lower  
for control arm  
with accessories

Required quantity  
reinforced version

2

**References**

Audi 4A0 399 347 C  
Audi 4A0 407 181 A  
Audi (FAW) 4A0 407 181 A

Audi 4A0 399 413 A  
Audi 4A0 407 201  
Audi (FAW) 4A0 407 201

**Application info**

Audi 100 (4A, C4) (12/90-11/94)

Audi A6 I (4A, C4) (06/94-12/97)

**Repair kit, ball joint**

016 010 0019/HD

MCX0045HD

**Notes**

Carbon Neutral  
Front Axle Left  
Front Axle Right

Required quantity

2

**References**

Smart 0014224V002  
Smart 0015642V002000000  
Smart 14224V002000000

Smart 0014224V002000000  
Smart 14224V001000  
Smart 2271V007000005

**Application info**

Smart City Coupé / Cabrio (07/98-01/04)  
Smart Fortwo I (01/04-02/07)

Smart Crossblade (06/02-12/03)  
Smart Roadster (04/03-11/05)

## Repair kit, ball joint

016 010 0029/HD

MAX0147HD

## Notes

Front Axle Left  
Front Axle Right  
with mounting tool



## References

Mercedes-Benz 163 350 00 13  
Mercedes-Benz A 163 350 00 13

Mercedes-Benz 163 350 01 13  
Mercedes-Benz A 163 350 01 13

## Application info

Mercedes-Benz BM 163 (M-Class) (02/98-07/05)

## Repair kit, ball joint

016 010 0033/HD

MCX0696HD

## Notes

Front Axle





## References



Mercedes-Benz 163 330 00 35  
Mercedes-Benz A 163 330 00 35

Mercedes-Benz 163 330 01 35  
Mercedes-Benz A 163 330 01 35

## Application info

Mercedes-Benz BM 163 (M-Class) (02/98-07/05)

Repair kit, ball joint		11-16 010 0018/S	MCX0428
<b>Notes</b>			
Required quantity	Front Axle Left Front Axle Right Lower without ball joint 2		
<b>References</b>			
Citroën 3640.58		Citroën 3640.69	
Citroën 3640.72		Peugeot 3640.58	
Peugeot 3640.69		Peugeot 3640.72	
<b>Application info</b>			
Citroën C5 III (RD_, TD_) (02/08--)		Citroën C6 (09/05-12/12)	
Peugeot 407 (02/04--)		Peugeot 508 I (11/10--)	
Repair kit, ball joint		11-16 010 0019	MCX0189
<b>Notes</b>			
Required quantity	Front Axle Left Front Axle Right Lower outer 2		
<b>References</b>			
Citroën 3640.57		Citroën 3640.69	
Citroën 3640.72		Citroën 3640.74	
Peugeot 3640.57		Peugeot 3640.69	
Peugeot 3640.72		Peugeot 3640.74	
<b>Application info</b>			
Citroën C5 III (RD_, TD_) (02/08--)		Citroën C6 (09/05-12/12)	
Peugeot 407 (02/04--)		Peugeot 508 I (11/10--)	

Repair kit, ball joint		11-16 010 0030	MAX0148
<b>Notes</b>	Front Axle Left Front Axle Right Lower outer with mounting tool		
Thread Size	M14x1,5		
<b>References</b>			
Citroën 98 186 575 80		Citroën 98 345 990 80	
Peugeot 98 18 657 580		Peugeot 98 34 599 080	
Toyota SU001-A6525		Toyota SU001-A8260	
<b>Application info</b>			
Citroën Jumpy III (04/16--)		Citroën Spacetourer (04/16--)	
Peugeot Expert III (04/16--)		Peugeot Traveller (04/16--)	
Toyota Proace II (02/16--)			
Repair kit, ball joint		11-16 010 0031	MAX0150
<b>Notes</b>	Front Axle Left Front Axle Right Lower outer with mounting tool		
Thread Size 1	M14x1,5		
Thread Size 2	M42x1,5		
<b>References</b>			
Citroën 3640.57		Citroën 3640.74	
Peugeot 3640.57		Peugeot 3640.74	
<b>Application info</b>			
Citroën C5 III (RD_, TD_) (02/08--)		Citroën C6 (09/05-12/12)	
Peugeot 407 (02/04--)		Peugeot 508 I (11/10--)	



**Repair kit, ball joint**

11-16 010 0032

MAX0151

**Notes**

Front Axle Left  
 Front Axle Right  
 Lower  
 outer  
 with mounting tool



**References**

Citroën 3640.57  
 Citroën 3640.72  
 Peugeot 3640.57  
 Peugeot 3640.72

Citroën 3640.69  
 Citroën 3640.74  
 Peugeot 3640.69  
 Peugeot 3640.74

**Application info**

Citroën C5 III (RD\_, TD\_) (02/08--)  
 Peugeot 407 (02/04--)

Citroën C6 (09/05-12/12)  
 Peugeot 508 I (11/10--)

**Repair kit, strut mount**

100 641 1002/HD

MCX0561HD

**Notes**

reinforced version

Front Axle  
 Set  
 with rolling bearing



**References**

Volkswagen 7E0 412 249  
 Volkswagen 7E0 412 249 B  
 Volkswagen 7E0 412 331 A  
 Volkswagen 7H0 412 341 A  
 Volkswagen 7LA 412 331

Volkswagen 7E0 412 249 A  
 Volkswagen 7E0 412 331  
 Volkswagen 7H0 412 249 A  
 Volkswagen 7LA 412 249  
 Volkswagen 7LA 412 331 A

**Application info**

Volkswagen Transporter V (04/03-08/15)

Volkswagen Transporter VI (04/15--)

**Repair kit, stub axle**

016 754 0001

MCX0655

**Notes**

Rear Axle Left  
Rear Axle Right  
with mounting sleeves

Required quantity  
replacement in pairs recommended

2



**References**

Jaguar C2C12119

Jaguar C2C36866

Mercedes-Benz 204 352 00 27

Mercedes-Benz 220 352 00 27

Mercedes-Benz 221 352 00 27

Mercedes-Benz 230 352 00 27

Mercedes-Benz A 201 352 00 27

Mercedes-Benz A 211 350 18 06

Mercedes-Benz A 220 352 02 27

Mercedes-Benz A 221 352 01 27

Mercedes-Benz A 231 333 02 27

Mercedes-Benz (BBDC) A 204 352 00 27

Jaguar C2C18350

Mercedes-Benz 201 352 00 27

Mercedes-Benz 211 350 18 06

Mercedes-Benz 220 352 02 27

Mercedes-Benz 221 352 01 27

Mercedes-Benz 231 333 02 27

Mercedes-Benz A 204 352 00 27

Mercedes-Benz A 220 352 00 27

Mercedes-Benz A 221 352 00 27

Mercedes-Benz A 230 352 00 27

Mercedes-Benz (BBDC) 204 352 00 27

**Application info**

Jaguar S-Type (CCX) (10/98-12/08)	Jaguar XF I (X250) (03/08--)
Jaguar XK (03/06-12/14)	Mercedes-Benz BM 124 (12/84-12/93)
Mercedes-Benz BM 124 (E-Class) (02/93-03/98)	Mercedes-Benz BM 129 (SL) (03/89-09/04)
Mercedes-Benz BM 140 (S-Class) (02/91-12/99)	Mercedes-Benz BM 170 (SLK) (04/96-04/04)
Mercedes-Benz BM 171 (SLK) (03/04-12/11)	Mercedes-Benz BM 172 (SLC) (01/16--)
Mercedes-Benz BM 172 (SLK) (01/11--)	Mercedes-Benz BM 201 ( 190) (10/82-08/93)
Mercedes-Benz BM 202 (C-Class) (03/93-03/01)	Mercedes-Benz BM 203 (C-Class) (05/00-06/11)
Mercedes-Benz BM 204 (C-Class) (01/07--)	Mercedes-Benz BM 204 (GLK-Class) (06/08-12/15)
Mercedes-Benz BM 205 (C-Class) (12/13--)	Mercedes-Benz BM 207 (E-Class) (01/09-12/16)
Mercedes-Benz BM 208 (CLK) (06/97-12/03)	Mercedes-Benz BM 209 (CLK) (05/02-03/10)
Mercedes-Benz BM 210 (E-Class) (06/95-08/03)	Mercedes-Benz BM 211 (E-Class) (03/02-07/09)
Mercedes-Benz BM 212 (E-Class) (01/09-12/16)	Mercedes-Benz BM 213 (E-Class) (01/16--)
Mercedes-Benz BM 215 (S-Class) (03/99-12/06)	Mercedes-Benz BM 216 (S-Class) (05/06-12/13)
Mercedes-Benz BM 217 (S-Class) (12/15--)	Mercedes-Benz BM 218 (CLS) (01/11-12/17)
Mercedes-Benz BM 219 (CLS) (10/04-02/11)	Mercedes-Benz BM 220 (S-Class) (09/98-08/05)
Mercedes-Benz BM 221 (S-Class) (09/05-12/13)	Mercedes-Benz BM 222 (S-Class) (05/13--)
Mercedes-Benz BM 230 (SL) (10/01-01/12)	Mercedes-Benz BM 231 (SL) (01/12--)
Mercedes-Benz BM 238 (E-Class) (06/17--)	Mercedes-Benz BM 253 (GLC) (06/15--)
Mercedes-Benz BM 257 (CLS-Class) (12/17--)	

**Rod/strut, suspension****016 030 0011****MSR0001****Notes**

Aluminium  
Guide Rod  
Lower  
Rear Axle Left

Length [mm]

440

Paired article number

016 030 0012 | MSR0002

Required quantity

1

replacement in pairs recommended

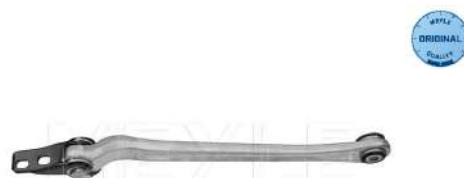
**References**

Mercedes-Benz 230 350 03 29

Mercedes-Benz A 230 350 03 29

Mercedes-Benz (BBDC) 230 350 03 29

Mercedes-Benz (BBDC) A 230 350 03 29

**Application info**

Mercedes-Benz BM 211 (E-Class) (03/02-07/09)

Mercedes-Benz BM 219 (CLS) (10/04-02/11)

Mercedes-Benz BM 230 (SL) (10/01-01/12)

Rod/strut, suspension

016 030 0012

MSR0002

Notes

Aluminium  
Guide Rod  
Lower  
Rear Axle Right

Length [mm] 440  
Paired article number 016 030 0011 | MSR0001  
Required quantity 1  
replacement in pairs recommended

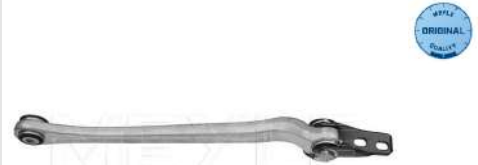

References

Mercedes-Benz 230 350 04 29 Mercedes-Benz A 230 350 04 29  
Mercedes-Benz (BBDC) 230 350 04 29 Mercedes-Benz (BBDC) A 230 350 04 29

Application info

Mercedes-Benz BM 211 (E-Class) (03/02-07/09) Mercedes-Benz BM 219 (CLS) (10/04-02/11)  
Mercedes-Benz BM 230 (SL) (10/01-01/12)

Rod/strut, suspension

016 035 0001

MSR0003

Notes

Aluminium  
Guide Rod  
Rear Axle Left  
with rubber mount

Inner Diameter [mm] 12  
Length [mm] 265  
Paired article number 016 035 0002 | MSR0004  
Required quantity 1  
replacement in pairs recommended

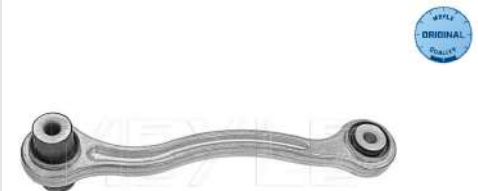

References

Mercedes-Benz 204 350 05 53 Mercedes-Benz 205 350 65 03  
Mercedes-Benz A 204 350 05 53 Mercedes-Benz A 205 350 65 03

Application info

Mercedes-Benz BM 204 (C-Class) (01/07--) Mercedes-Benz BM 204 (GLK-Class) (06/08-12/15)  
Mercedes-Benz BM 205 (C-Class) (12/13--) Mercedes-Benz BM 207 (E-Class) (01/09-12/16)  
Mercedes-Benz BM 212 (E-Class) (01/09-12/16) Mercedes-Benz BM 213 (E-Class) (01/16--)  
Mercedes-Benz BM 218 (CLS) (01/11-12/17) Mercedes-Benz BM 238 (E-Class) (06/17--)  
Mercedes-Benz BM 253 (GLC) (06/15--) Mercedes-Benz BM 257 (CLS-Class) (12/17--)  
Mercedes-Benz BM 293 (EQC) (05/19--)

**Rod/strut, suspension**

016 035 0002

MSR0004

**Notes**

Aluminium  
Guide Rod  
Rear Axle Right  
with rubber mount

Inner Diameter [mm] 12  
Length [mm] 265  
Paired article number 016 035 0001 | MSR0003  
Required quantity 1  
replacement in pairs recommended

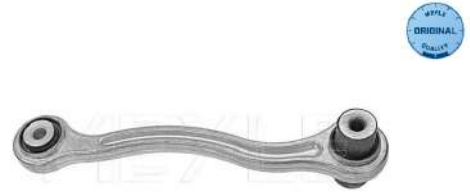

**References**

Mercedes-Benz 204 350 06 53 Mercedes-Benz 205 350 66 03  
Mercedes-Benz A 204 350 06 53 Mercedes-Benz A 205 350 66 03

**Application info**

Mercedes-Benz BM 204 (C-Class) (01/07--)  
Mercedes-Benz BM 205 (C-Class) (12/13--)  
Mercedes-Benz BM 212 (E-Class) (01/09-12/16)  
Mercedes-Benz BM 218 (CLS) (01/11-12/17)  
Mercedes-Benz BM 253 (GLC) (06/15--)  
Mercedes-Benz BM 293 (EQC) (05/19--)  
Mercedes-Benz BM 204 (GLK-Class) (06/08-12/15)  
Mercedes-Benz BM 207 (E-Class) (01/09-12/16)  
Mercedes-Benz BM 213 (E-Class) (01/16--)  
Mercedes-Benz BM 238 (E-Class) (06/17--)  
Mercedes-Benz BM 257 (CLS-Class) (12/17--)

**Rod/strut, suspension**

016 035 0003

MSR0005

**Notes**

Aluminium  
Front  
Guide Rod  
Rear Axle Left  
Upper

Length [mm] 312  
Paired article number 016 035 0004 | MSR0006  
Required quantity 1  
replacement in pairs recommended



**References**

Mercedes-Benz 204 350 21 06 Mercedes-Benz A 204 350 21 06  
Mercedes-Benz (BBDC) 204 350 21 06 Mercedes-Benz (BBDC) A 204 350 21 06

**Application info**

Mercedes-Benz BM 204 (C-Class) (01/07--)  
 Mercedes-Benz BM 205 (C-Class) (12/13--)  
 Mercedes-Benz BM 212 (E-Class) (01/09-12/16)  
 Mercedes-Benz BM 218 (CLS) (01/11-12/17)  
 Mercedes-Benz BM 253 (GLC) (06/15--)  
 Mercedes-Benz BM 293 (EQC) (05/19--)

Mercedes-Benz BM 204 (GLK-Class) (06/08-12/15)  
 Mercedes-Benz BM 207 (E-Class) (01/09-12/16)  
 Mercedes-Benz BM 213 (E-Class) (01/16--)  
 Mercedes-Benz BM 238 (E-Class) (06/17--)  
 Mercedes-Benz BM 257 (CLS-Class) (12/17--)

**Rod/strut, suspension**

016 035 0004

MSR0006

**Notes**

Aluminium  
 Front  
 Guide Rod  
 Rear Axle Right  
 Upper

Length [mm] 312  
 Paired article number 016 035 0003 | MSR0005  
 Required quantity 1  
 replacement in pairs recommended



**References**

Mercedes-Benz 204 350 22 06  
 Mercedes-Benz (BBDC) 204 350 22 06

Mercedes-Benz A 204 350 22 06  
 Mercedes-Benz (BBDC) A 204 350 22 06

**Application info**

Mercedes-Benz BM 204 (C-Class) (01/07--)  
 Mercedes-Benz BM 205 (C-Class) (12/13--)  
 Mercedes-Benz BM 212 (E-Class) (01/09-12/16)  
 Mercedes-Benz BM 218 (CLS) (01/11-12/17)  
 Mercedes-Benz BM 253 (GLC) (06/15--)  
 Mercedes-Benz BM 293 (EQC) (05/19--)

Mercedes-Benz BM 204 (GLK-Class) (06/08-12/15)  
 Mercedes-Benz BM 207 (E-Class) (01/09-12/16)  
 Mercedes-Benz BM 213 (E-Class) (01/16--)  
 Mercedes-Benz BM 238 (E-Class) (06/17--)  
 Mercedes-Benz BM 257 (CLS-Class) (12/17--)

**Rod/strut, suspension**

016 035 0005

MSR0007

**Notes**

Aluminium  
 Guide Rod  
 Rear  
 Rear Axle Left  
 Upper

Length [mm] 343  
 Paired article number 016 035 0006 | MSR0008  
 Required quantity 1  
 replacement in pairs recommended



**References**

- Mercedes-Benz 204 350 15 06
- Mercedes-Benz 205 350 61 03
- Mercedes-Benz A 204 350 30 06
- Mercedes-Benz (BBDC) 205 350 61 03
- Mercedes-Benz 204 350 30 06
- Mercedes-Benz A 204 350 15 06
- Mercedes-Benz A 205 350 61 03
- Mercedes-Benz (BBDC) A 205 350 61 03

**Application info**

- Mercedes-Benz BM 204 (C-Class) (01/07--)
- Mercedes-Benz BM 205 (C-Class) (12/13--)
- Mercedes-Benz BM 212 (E-Class) (01/09-12/16)
- Mercedes-Benz BM 218 (CLS) (01/11-12/17)
- Mercedes-Benz BM 238 (E-Class) (06/17--)
- Mercedes-Benz BM 257 (CLS-Class) (12/17--)
- Mercedes-Benz BM 204 (GLK-Class) (06/08-12/15)
- Mercedes-Benz BM 207 (E-Class) (01/09-12/16)
- Mercedes-Benz BM 213 (E-Class) (01/16--)
- Mercedes-Benz BM 231 (SL) (01/12--)
- Mercedes-Benz BM 253 (GLC) (06/15--)
- Mercedes-Benz BM 293 (EQC) (05/19--)

**Rod/strut, suspension**

016 035 0006

MSR0008

**Notes**

Aluminium  
Guide Rod  
Rear  
Rear Axle Right  
Upper

Length [mm] 343  
Paired article number 016 035 0005 | MSR0007  
Required quantity 1  
replacement in pairs recommended



**References**

- Mercedes-Benz 204 350 16 06
- Mercedes-Benz 205 350 62 03
- Mercedes-Benz A 204 350 31 06
- Mercedes-Benz (BBDC) 205 350 62 03
- Mercedes-Benz 204 350 31 06
- Mercedes-Benz A 204 350 16 06
- Mercedes-Benz A 205 350 62 03
- Mercedes-Benz (BBDC) A 205 350 62 03

**Application info**

- Mercedes-Benz BM 204 (C-Class) (01/07--)
- Mercedes-Benz BM 205 (C-Class) (12/13--)
- Mercedes-Benz BM 212 (E-Class) (01/09-12/16)
- Mercedes-Benz BM 218 (CLS) (01/11-12/17)
- Mercedes-Benz BM 238 (E-Class) (06/17--)
- Mercedes-Benz BM 257 (CLS-Class) (12/17--)
- Mercedes-Benz BM 204 (GLK-Class) (06/08-12/15)
- Mercedes-Benz BM 207 (E-Class) (01/09-12/16)
- Mercedes-Benz BM 213 (E-Class) (01/16--)
- Mercedes-Benz BM 231 (SL) (01/12--)
- Mercedes-Benz BM 253 (GLC) (06/15--)
- Mercedes-Benz BM 293 (EQC) (05/19--)

**Rod/strut, suspension** **016 035 0010** **MSR0009**

**Notes**

Aluminium  
 Guide Rod  
 Rear  
 Rear Axle Left  
 Upper  
 with rubber mount

Length [mm] 325  
 Paired article number 016 035 0011 | MSR0010  
 Required quantity 1  
 replacement in pairs recommended



**References**

Mercedes-Benz 230 350 27 06 Mercedes-Benz A 230 350 27 06  
 Mercedes-Benz (BBDC) 230 350 27 06 Mercedes-Benz (BBDC) A 230 350 27 06

**Application info**

Mercedes-Benz BM 211 (E-Class) (03/02-07/09) Mercedes-Benz BM 219 (CLS) (10/04-02/11)  
 Mercedes-Benz BM 230 (SL) (10/01-01/12)

**Rod/strut, suspension** **016 035 0011** **MSR0010**

**Notes**

Aluminium  
 Guide Rod  
 Rear  
 Rear Axle Right  
 Upper  
 with rubber mount

Length [mm] 325  
 Paired article number 016 035 0010 | MSR0009  
 Required quantity 1  
 replacement in pairs recommended





**References**

Mercedes-Benz 230 350 28 06 Mercedes-Benz A 230 350 28 06  
 Mercedes-Benz (BBDC) 230 350 28 06 Mercedes-Benz (BBDC) A 230 350 28 06

**Application info**

Mercedes-Benz BM 211 (E-Class) (03/02-07/09) Mercedes-Benz BM 219 (CLS) (10/04-02/11)  
 Mercedes-Benz BM 230 (SL) (10/01-01/12)

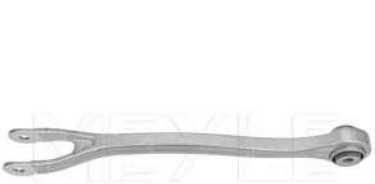

Rod/strut, suspension		016 035 0012	MSR0011
<p><b>Notes</b></p> <p>Aluminium Front Guide Rod Rear Axle Left Upper with rubber mount</p> <p>Length [mm] 261 Paired article number 016 035 0013   MSR0012 Required quantity 1 replacement in pairs recommended</p>			
<p><b>References</b></p> <p>Mercedes-Benz 230 350 35 06 Mercedes-Benz A 230 350 35 06 Mercedes-Benz (BBDC) 230 350 35 06 Mercedes-Benz (BBDC) A 230 350 35 06</p>			
<p><b>Application info</b></p> <p>Mercedes-Benz BM 211 (E-Class) (03/02-07/09) Mercedes-Benz BM 219 (CLS) (10/04-02/11) Mercedes-Benz BM 230 (SL) (10/01-01/12)</p>			
Rod/strut, suspension		016 035 0013	MSR0012
<p><b>Notes</b></p> <p>Aluminium Front Guide Rod Rear Axle Right Upper with rubber mount</p> <p>Length [mm] 261 Paired article number 016 035 0012   MSR0011 Required quantity 1 replacement in pairs recommended</p>			
<p><b>References</b></p> <p>Mercedes-Benz 230 350 36 06 Mercedes-Benz A 230 350 36 06 Mercedes-Benz (BBDC) 230 350 36 06 Mercedes-Benz (BBDC) A 230 350 36 06</p>			
<p><b>Application info</b></p> <p>Mercedes-Benz BM 211 (E-Class) (03/02-07/09) Mercedes-Benz BM 219 (CLS) (10/04-02/11) Mercedes-Benz BM 230 (SL) (10/01-01/12)</p>			

Rod/strut, suspension		016 035 0014	MSR0013
<b>Notes</b>  Front Guide Rod Lower Rear Axle Left Rear Axle Right Sheet Steel with rubber mount  Length [mm] 332 Required quantity 2 replacement in pairs recommended			
<b>References</b> Mercedes-Benz 204 350 00 29 Mercedes-Benz 204 350 27 06 Mercedes-Benz 205 350 63 03 Mercedes-Benz A 204 350 00 29 Mercedes-Benz A 204 350 27 06 Mercedes-Benz A 205 350 63 03 Mercedes-Benz (BBDC) 204 350 27 06 Mercedes-Benz (BBDC) A 204 350 27 06			
<b>Application info</b> Mercedes-Benz BM 204 (C-Class) (01/07--) Mercedes-Benz BM 205 (C-Class) (12/13--) Mercedes-Benz BM 212 (E-Class) (01/09-12/16) Mercedes-Benz BM 218 (CLS) (01/11-12/17) Mercedes-Benz BM 253 (GLC) (06/15--) Mercedes-Benz BM 293 (EQC) (05/19--) Mercedes-Benz BM 204 (GLK-Class) (06/08-12/15) Mercedes-Benz BM 207 (E-Class) (01/09-12/16) Mercedes-Benz BM 213 (E-Class) (01/16--) Mercedes-Benz BM 238 (E-Class) (06/17--) Mercedes-Benz BM 257 (CLS-Class) (12/17--) 			
Rod/strut, suspension		016 035 0016	MSR0014
<b>Notes</b>  Aluminium Front Guide Rod Rear Axle Left Rear Axle Right  Length [mm] 367.5 Required quantity 2 replacement in pairs recommended			
<b>References</b> Mercedes-Benz 230 350 20 06 Mercedes-Benz A 230 350 20 06 Mercedes-Benz (BBDC) 230 350 20 06 Mercedes-Benz (BBDC) A 230 350 20 06			

**Application info**

Mercedes-Benz BM 211 (E-Class) (03/02-07/09)  
 Mercedes-Benz BM 230 (SL) (10/01-01/12)

Mercedes-Benz BM 219 (CLS) (10/04-02/11)

**Rod/strut, suspension**

016 035 0016/S

MSR0133

**Notes**

Aluminium  
 Front  
 Guide Rod  
 Rear Axle Left  
 Rear Axle Right  
 with accessories

Length [mm] 367.5  
 Required quantity 2  
 replacement in pairs recommended

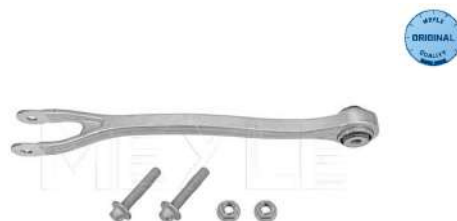

**References**

Mercedes-Benz 230 350 20 06  
 Mercedes-Benz (BBDC) 230 350 20 06

Mercedes-Benz A 230 350 20 06  
 Mercedes-Benz (BBDC) A 230 350 20 06

**Application info**

Mercedes-Benz BM 211 (E-Class) (03/02-07/09)  
 Mercedes-Benz BM 230 (SL) (10/01-01/12)

Mercedes-Benz BM 219 (CLS) (10/04-02/11)

**Rod/strut, suspension**

016 035 0017

MSR0123

**Notes**

Front  
 Guide Rod  
 Lower  
 Rear Axle Left  
 Rear Axle Right  
 Sheet Steel  
 with rubber mount

Length [mm] 207.5  
 Required quantity 2  
 replacement in pairs recommended

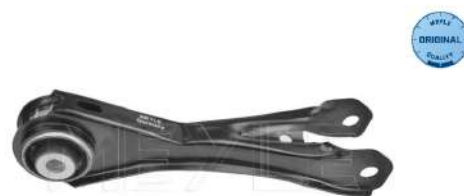

**References**

Infiniti 551A05DA0A  
 Mercedes-Benz A 246 350 00 53  
 Mercedes-Benz (BBDC) A 246 350 00 53

Mercedes-Benz 246 350 00 53  
 Mercedes-Benz (BBDC) 246 350 00 53

**Application info**

Infiniti Q30 (11/15--)

Mercedes-Benz BM 117 (CLA) (01/13-03/19)

Mercedes-Benz BM 176 (A-Class) (06/12-05/18)

Infiniti QX30 (04/16--)

Mercedes-Benz BM 156 (GLA-Class) (12/13--)

Mercedes-Benz BM 246 (B-Class) (10/11-12/18)

**Rod/strut, suspension**

016 035 0020

MSR0015

**Notes**

Aluminium  
Guide Rod  
Rear  
Rear Axle Left  
Rear Axle Right  
Upper

Length [mm]

322

Required quantity

2

replacement in pairs recommended



**References**

Mercedes-Benz 220 350 24 06

Mercedes-Benz A 220 350 24 06

**Application info**

Mercedes-Benz BM 215 (S-Class) (03/99-12/06)

Mercedes-Benz BM 220 (S-Class) (09/98-08/05)

**Rod/strut, suspension**

016 035 0021

MSR0016

**Notes**

Aluminium  
Guide Rod  
Rear  
Rear Axle Left  
Rear Axle Right  
Upper  
with rubber mount

Length [mm]

395

Required quantity

2

replacement in pairs recommended



**References**

Mercedes-Benz 220 350 22 06

Mercedes-Benz A 220 350 22 06

**Application info**

Mercedes-Benz BM 215 (S-Class) (03/99-12/06)

Mercedes-Benz BM 220 (S-Class) (09/98-08/05)

## Rod/strut, suspension

016 035 0022

MSR0017

## Notes

Guide Rod  
 Lower  
 Rear  
 Rear Axle Left  
 Rear Axle Right  
 Steel

Length [mm] 257  
 Required quantity 2  
 Thread Size M10x1,5  
 replacement in pairs recommended

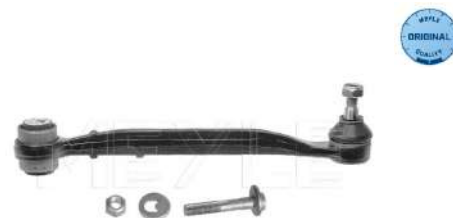

## References

Mercedes-Benz 203 350 03 53  
 Mercedes-Benz A 203 350 03 53

Mercedes-Benz 203 350 07 53  
 Mercedes-Benz A 203 350 07 53

## Application info

Mercedes-Benz BM 171 (SLK) (03/04-12/11)  
 Mercedes-Benz BM 208 (CLK) (06/97-12/03)

Mercedes-Benz BM 203 (C-Class) (05/00-06/11)  
 Mercedes-Benz BM 209 (CLK) (05/02-03/10)

## Rod/strut, suspension

016 035 0027

MSR0112

## Notes

Guide Rod  
 Rear  
 Rear Axle Left  
 Rear Axle Right  
 Steel

Length [mm] 522  
 Required quantity 2  
 replacement in pairs recommended



## References



Mercedes-Benz 164 350 00 53  
 Mercedes-Benz A 164 350 00 53

Mercedes-Benz 166 350 00 53  
 Mercedes-Benz A 166 350 00 53

## Application info

Mercedes-Benz BM 164 (GL-Class) (09/06-12/12)  
 Mercedes-Benz BM 166 (GL) (07/12-12/15)  
 Mercedes-Benz BM 166 (GLS) (11/15-04/19)  
 Mercedes-Benz BM 251 (R-Class) (08/05-10/17)

Mercedes-Benz BM 164 (M-Class) (02/05-12/12)  
 Mercedes-Benz BM 166 (GLE) (03/15-10/19)  
 Mercedes-Benz BM 166 (M-Class) (06/11-12/15)

Rod/strut, suspension		016 035 0028	MSR0117
<b>Notes</b>  Front Guide Rod Rear Axle Left Rear Axle Right Steel Upper with rubber mount  Length [mm] 383 Required quantity 2 replacement in pairs recommended			
<b>References</b> Mercedes-Benz 164 350 14 06		Mercedes-Benz A 164 350 14 06	
<b>Application info</b> Mercedes-Benz BM 164 (GL-Class) (09/06-12/12) Mercedes-Benz BM 251 (R-Class) (08/05-10/17)		Mercedes-Benz BM 164 (M-Class) (02/05-12/12)	
Rod/strut, suspension		016 035 0038	MSR0019
<b>Notes</b>  Guide Rod Rear Rear Axle Left Rear Axle Right Sheet Steel Upper  Length [mm] 298 Required quantity 2 replacement in pairs recommended			

**References**

Chrysler K05099786AA	Mercedes-Benz 124 350 08 06
Mercedes-Benz 124 350 59 06	Mercedes-Benz 124 350 70 06
Mercedes-Benz 124 350 76 06	Mercedes-Benz 124 350 77 06
Mercedes-Benz 129 350 04 06	Mercedes-Benz 129 350 05 06
Mercedes-Benz 210 350 16 06	Mercedes-Benz 210 350 17 06
Mercedes-Benz 210 350 24 06	Mercedes-Benz 210 350 25 06
Mercedes-Benz 210 350 34 06	Mercedes-Benz 210 350 35 06
Mercedes-Benz A 124 350 08 06	Mercedes-Benz A 124 350 59 06
Mercedes-Benz A 124 350 70 06	Mercedes-Benz A 124 350 76 06
Mercedes-Benz A 124 350 77 06	Mercedes-Benz A 129 350 04 06
Mercedes-Benz A 129 350 05 06	Mercedes-Benz A 210 350 16 06
Mercedes-Benz A 210 350 17 06	Mercedes-Benz A 210 350 24 06
Mercedes-Benz A 210 350 25 06	Mercedes-Benz A 210 350 34 06
Mercedes-Benz A 210 350 35 06	

**Application info**

Chrysler Crossfire (07/03-12/08)	Mercedes-Benz BM 124 (12/84-12/93)
Mercedes-Benz BM 124 (E-Class) (02/93-03/98)	Mercedes-Benz BM 129 (SL) (03/89-09/04)
Mercedes-Benz BM 170 (SLK) (04/96-04/04)	Mercedes-Benz BM 171 (SLK) (03/04-12/11)
Mercedes-Benz BM 201 ( 190) (10/82-08/93)	Mercedes-Benz BM 202 (C-Class) (03/93-03/01)
Mercedes-Benz BM 203 (C-Class) (05/00-06/11)	Mercedes-Benz BM 208 (CLK) (06/97-12/03)
Mercedes-Benz BM 209 (CLK) (05/02-03/10)	Mercedes-Benz BM 210 (E-Class) (06/95-08/03)

**Rod/strut, suspension**

016 035 0038/S

MSR0020

**Notes**

Guide Rod  
 Rear  
 Rear Axle Left  
 Rear Axle Right  
 Sheet Steel  
 Upper  
 with accessories

Length [mm]

298

Required quantity

2

replacement in pairs recommended



**References**

Chrysler K05099786AA	Mercedes-Benz 124 350 08 06
Mercedes-Benz 124 350 59 06	Mercedes-Benz 124 350 70 06
Mercedes-Benz 124 350 76 06	Mercedes-Benz 124 350 77 06
Mercedes-Benz 129 350 04 06	Mercedes-Benz 129 350 05 06
Mercedes-Benz 210 350 16 06	Mercedes-Benz 210 350 17 06
Mercedes-Benz 210 350 24 06	Mercedes-Benz 210 350 25 06
Mercedes-Benz 210 350 34 06	Mercedes-Benz 210 350 35 06
Mercedes-Benz A 124 350 08 06	Mercedes-Benz A 124 350 59 06
Mercedes-Benz A 124 350 70 06	Mercedes-Benz A 124 350 76 06
Mercedes-Benz A 124 350 77 06	Mercedes-Benz A 129 350 04 06
Mercedes-Benz A 129 350 05 06	Mercedes-Benz A 210 350 16 06
Mercedes-Benz A 210 350 17 06	Mercedes-Benz A 210 350 24 06
Mercedes-Benz A 210 350 25 06	Mercedes-Benz A 210 350 34 06
Mercedes-Benz A 210 350 35 06	

**Application info**

Chrysler Crossfire (07/03-12/08)	Mercedes-Benz BM 124 (12/84-12/93)
Mercedes-Benz BM 124 (E-Class) (02/93-03/98)	Mercedes-Benz BM 129 (SL) (03/89-09/04)
Mercedes-Benz BM 170 (SLK) (04/96-04/04)	Mercedes-Benz BM 171 (SLK) (03/04-12/11)
Mercedes-Benz BM 201 ( 190) (10/82-08/93)	Mercedes-Benz BM 202 (C-Class) (03/93-03/01)
Mercedes-Benz BM 203 (C-Class) (05/00-06/11)	Mercedes-Benz BM 208 (CLK) (06/97-12/03)
Mercedes-Benz BM 209 (CLK) (05/02-03/10)	Mercedes-Benz BM 210 (E-Class) (06/95-08/03)

**Rod/strut, suspension**

016 035 0039

MSR0021

**Notes**

Front  
 Guide Rod  
 Lower  
 Rear Axle Left  
 Rear Axle Right  
 Sheet Steel

Length [mm] 315  
 Required quantity 2  
 replacement in pairs recommended



**References**

Chrysler K051134572AA	Mercedes-Benz 124 350 01 29
Mercedes-Benz 210 350 00 29	Mercedes-Benz 210 350 38 06
Mercedes-Benz A 124 350 01 29	Mercedes-Benz A 210 350 00 29
Mercedes-Benz A 210 350 38 06	



**Application info**

Chrysler Crossfire (07/03-12/08)

Mercedes-Benz BM 124 (E-Class) (02/93-03/98)

Mercedes-Benz BM 170 (SLK) (04/96-04/04)

Mercedes-Benz BM 201 ( 190) (10/82-08/93)

Mercedes-Benz BM 203 (C-Class) (05/00-06/11)

Mercedes-Benz BM 209 (CLK) (05/02-03/10)

Mercedes-Benz BM 124 (12/84-12/93)

Mercedes-Benz BM 129 (SL) (03/89-09/04)

Mercedes-Benz BM 171 (SLK) (03/04-12/11)

Mercedes-Benz BM 202 (C-Class) (03/93-03/01)

Mercedes-Benz BM 208 (CLK) (06/97-12/03)

Mercedes-Benz BM 210 (E-Class) (06/95-08/03)

**Rod/strut, suspension****016 035 0039/S****MSR0022****Notes**

Front  
Guide Rod  
Lower  
Rear Axle Left  
Rear Axle Right  
Sheet Steel  
with accessories

Length [mm]

315

Required quantity

2

replacement in pairs recommended

**References**

Chrysler K051134572AA

Mercedes-Benz 124 350 65 06

Mercedes-Benz 210 350 38 06

Mercedes-Benz A 124 350 65 06

Mercedes-Benz A 210 350 38 06

Mercedes-Benz 124 350 01 29

Mercedes-Benz 210 350 00 29

Mercedes-Benz A 124 350 01 29

Mercedes-Benz A 210 350 00 29

**Application info**

Chrysler Crossfire (07/03-12/08)

Mercedes-Benz BM 124 (E-Class) (02/93-03/98)

Mercedes-Benz BM 170 (SLK) (04/96-04/04)

Mercedes-Benz BM 201 ( 190) (10/82-08/93)

Mercedes-Benz BM 203 (C-Class) (05/00-06/11)

Mercedes-Benz BM 209 (CLK) (05/02-03/10)

Mercedes-Benz BM 124 (12/84-12/93)

Mercedes-Benz BM 129 (SL) (03/89-09/04)

Mercedes-Benz BM 171 (SLK) (03/04-12/11)

Mercedes-Benz BM 202 (C-Class) (03/93-03/01)

Mercedes-Benz BM 208 (CLK) (06/97-12/03)

Mercedes-Benz BM 210 (E-Class) (06/95-08/03)

**Rod/strut, suspension**

016 035 0040

MSR0023

**Notes**

Front  
 Guide Rod  
 Rear Axle Left  
 Rear Axle Right  
 Sheet Steel  
 Upper

Length [mm] 247  
 Required quantity 2  
 replacement in pairs recommended



**References**

- |                               |                               |
|-------------------------------|-------------------------------|
| Chrysler K05099785AA          | Mercedes-Benz 124 350 42 06   |
| Mercedes-Benz 201 350 39 06   | Mercedes-Benz 201 350 43 06   |
| Mercedes-Benz 201 350 44 06   | Mercedes-Benz 201 350 47 06   |
| Mercedes-Benz 201 350 56 06   | Mercedes-Benz 210 350 33 06   |
| Mercedes-Benz A 124 350 42 06 | Mercedes-Benz A 201 350 39 06 |
| Mercedes-Benz A 201 350 43 06 | Mercedes-Benz A 201 350 44 06 |
| Mercedes-Benz A 201 350 47 06 | Mercedes-Benz A 201 350 56 06 |
| Mercedes-Benz A 210 350 33 06 |                               |

**Application info**

- |  |  |
|--|--|
| Chrysler Crossfire (07/03-12/08)             | Mercedes-Benz BM 124 (12/84-12/93)           |
| Mercedes-Benz BM 124 (E-Class) (02/93-03/98) | Mercedes-Benz BM 129 (SL) (03/89-09/04)      |
| Mercedes-Benz BM 170 (SLK) (04/96-04/04)     | Mercedes-Benz BM 171 (SLK) (03/04-12/11)     |
| Mercedes-Benz BM 201 ( 190) (10/82-08/93)    | Mercedes-Benz BM 202 (C-Class) (03/93-03/01) |
| Mercedes-Benz BM 203 (C-Class) (05/00-06/11) | Mercedes-Benz BM 208 (CLK) (06/97-12/03)     |
| Mercedes-Benz BM 209 (CLK) (05/02-03/10)     | Mercedes-Benz BM 210 (E-Class) (06/95-08/03) |

**Rod/strut, suspension**

016 035 0040/S

MSR0024

**Notes**

Front  
 Guide Rod  
 Rear Axle Left  
 Rear Axle Right  
 Sheet Steel  
 Upper  
 with accessories

Length [mm] 247  
 Required quantity 2  
 replacement in pairs recommended



**References**

Chrysler K05099785AA	Mercedes-Benz 124 350 42 06
Mercedes-Benz 201 350 39 06	Mercedes-Benz 201 350 43 06
Mercedes-Benz 201 350 44 06	Mercedes-Benz 201 350 47 06
Mercedes-Benz 201 350 56 06	Mercedes-Benz 210 350 33 06
Mercedes-Benz A 124 350 42 06	Mercedes-Benz A 201 350 39 06
Mercedes-Benz A 201 350 43 06	Mercedes-Benz A 201 350 44 06
Mercedes-Benz A 201 350 47 06	Mercedes-Benz A 201 350 56 06
Mercedes-Benz A 210 350 33 06	

**Application info**

Chrysler Crossfire (07/03-12/08)	Mercedes-Benz BM 124 (12/84-12/93)
Mercedes-Benz BM 124 (E-Class) (02/93-03/98)	Mercedes-Benz BM 129 (SL) (03/89-09/04)
Mercedes-Benz BM 170 (SLK) (04/96-04/04)	Mercedes-Benz BM 171 (SLK) (03/04-12/11)
Mercedes-Benz BM 201 ( 190) (10/82-08/93)	Mercedes-Benz BM 202 (C-Class) (03/93-03/01)
Mercedes-Benz BM 203 (C-Class) (05/00-06/11)	Mercedes-Benz BM 208 (CLK) (06/97-12/03)
Mercedes-Benz BM 209 (CLK) (05/02-03/10)	Mercedes-Benz BM 210 (E-Class) (06/95-08/03)

**Rod/strut, suspension**

**016 035 0046 | MSR0029**

**Notes**

	Aluminium
	Guide Rod
	Rear Axle Left
Length [mm]	285
Paired article number	016 035 0047   MSR0030
Required quantity	1
replacement in pairs recommended	



**References**

Mercedes-Benz 221 350 11 53	Mercedes-Benz A 221 350 11 53
-----------------------------	-------------------------------

**Application info**

Mercedes-Benz BM 216 (S-Class) (05/06-12/13)	Mercedes-Benz BM 221 (S-Class) (09/05-12/13)
--	--

**Rod/strut, suspension**

016 035 0047

MSR0030

**Notes**

Aluminium  
 Guide Rod  
 Rear Axle Right  
 Length [mm] 285  
 Paired article number 016 035 0046 | MSR0029  
 Required quantity 1  
 replacement in pairs recommended

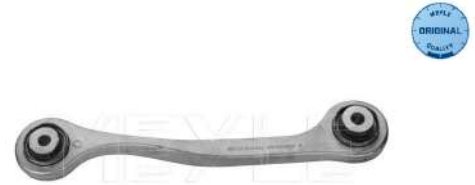

**References**

Mercedes-Benz 221 350 12 53

Mercedes-Benz A 221 350 12 53

**Application info**

Mercedes-Benz BM 216 (S-Class) (05/06-12/13)

Mercedes-Benz BM 221 (S-Class) (09/05-12/13)

**Rod/strut, suspension**

016 039 6300

MSR0039

**Notes**

Guide Rod  
 Rear Axle Left  
 Rear Axle Right  
 Steel  
 Length [mm] 245  
 Required quantity 2  
 Thread Size M10x1  
 replacement in pairs recommended



**References**

Chrysler K05143012AA

Mercedes-Benz 201 350 19 53

Mercedes-Benz 201 350 32 53

Mercedes-Benz 210 350 18 53

Mercedes-Benz A 201 350 19 53

Mercedes-Benz A 201 350 32 53

Mercedes-Benz A 210 350 18 53

**Application info**

Chrysler Crossfire (07/03-12/08)

Mercedes-Benz BM 124 (12/84-12/93)

Mercedes-Benz BM 124 (E-Class) (02/93-03/98)

Mercedes-Benz BM 129 (SL) (03/89-09/04)

Mercedes-Benz BM 170 (SLK) (04/96-04/04)

Mercedes-Benz BM 201 ( 190) (10/82-08/93)

Mercedes-Benz BM 202 (C-Class) (03/93-03/01)

Mercedes-Benz BM 208 (CLK) (06/97-12/03)

Mercedes-Benz BM 210 (E-Class) (06/95-08/03)

## Rod/strut, suspension

016 039 6301

MSR0040

## Notes

Guide Rod  
Rear Axle Left  
Rear Axle Right  
Steel  
with accessories

Length [mm]

245

Required quantity

2

Thread Size

M10x1

replacement in pairs recommended



## References

Mercedes-Benz 124 350 01 53

Mercedes-Benz 210 350 09 53

Mercedes-Benz 210 350 21 53

Mercedes-Benz A 124 350 01 53

Mercedes-Benz A 210 350 09 53

Mercedes-Benz A 210 350 21 53

## Application info

Mercedes-Benz BM 124 (12/84-12/93)

Mercedes-Benz BM 124 (E-Class) (02/93-03/98)

Mercedes-Benz BM 129 (SL) (03/89-09/04)

Mercedes-Benz BM 170 (SLK) (04/96-04/04)

Mercedes-Benz BM 201 (190) (10/82-08/93)

Mercedes-Benz BM 202 (C-Class) (03/93-03/01)

Mercedes-Benz BM 208 (CLK) (06/97-12/03)

Mercedes-Benz BM 210 (E-Class) (06/95-08/03)

## Rod/strut, suspension

11-16 035 0000/HD

MSR0149HD

## Notes

Aluminium  
Carbon Neutral  
Guide Rod  
Lower  
Rear Axle Right  
with rubber mount

Bore Diameter 1 [mm]

12.5

Bore Diameter 2 [mm]

14.5

Length [mm]

392.4

Paired article number

11-16 035 0001/HD | MSR0150HD

Replace in pairs only

Required quantity

1

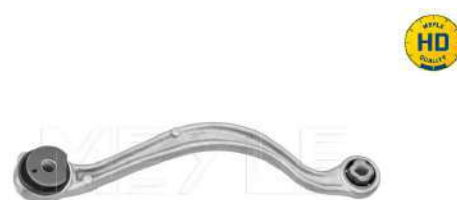

## References

Citroën 5175.CE

Citroën 98 011 457 80

DS 5175.CE

DS 98 011 457 80

Peugeot 5175.CE

Peugeot 98 011 457 80

**Application info**

Citroën C5 III (RD\_, TD\_) (02/08--)

Citroën DS5 (09/11-07/15)

Peugeot 407 (02/04--)

Citroën C6 (09/05-12/12)

DS DS 5 (04/15-12/18)

Peugeot 508 I (11/10--)

**Rod/strut, suspension****11-16 035 0001/HD****MSR0150HD****Notes**

Aluminium  
Carbon Neutral  
Guide Rod  
Lower  
Rear Axle Left  
with rubber mount

Bore Diameter 1 [mm]

12.5

Bore Diameter 2 [mm]

14.5

Length [mm]

392.4

Paired article number

11-16 035 0000/HD | MSR0149HD

Replace in pairs only

Required quantity

1

**References**

Citroën 5175.CC

DS 5175.CC

Peugeot 5175.CC

Citroën 98 011 458 80

DS 98 011 458 80

Peugeot 98 011 458 80

**Application info**

Citroën C5 III (RD\_, TD\_) (02/08--)

Citroën DS5 (09/11-07/15)

Peugeot 407 (02/04--)

Citroën C6 (09/05-12/12)

DS DS 5 (04/15-12/18)

Peugeot 508 I (11/10--)

**Rod/strut, suspension****11-16 035 0002****MSR0141****Notes**

Guide Rod  
Lower  
Rear  
Rear Axle Left  
Rear Axle Right  
Sheet Steel  
with rubber mount

Length [mm]

440

Required quantity

2

replacement in pairs recommended



**References**

Citroën 5175.CF

Peugeot 5175.CF

**Application info**

Citroën C5 III (RD\_, TD\_) (02/08--)

Citroën C6 (09/05-12/12)

Peugeot 407 (02/04--)

Peugeot 508 I (11/10--)

**Rod/strut, suspension****116 035 0002****MSR0054****Notes**

Guide Rod  
 Lower  
 Rear Axle Left  
 Sheet Steel  
 with rubber mount

Length [mm]

298

Paired article number

116 035 0003 | MSR0055

Required quantity

1

replacement in pairs recommended

**References**

Audi 1K0 501 529 F

Audi (FAW) 1K0 501 529 F

Seat 1K0 501 529 F

Seat 7N0 501 529

Skoda 1K0 501 529 F

Volkswagen 1K0 501 529 E

Volkswagen 1K0 501 529 F

Volkswagen 7N0 501 529

**Application info**

Audi A3 II (8P\_) (05/03-12/15)

Audi Q3 I (8U\_) (06/11-12/18)

Audi TT II (8J\_) (07/06-01/15)

Seat Alhambra II (710) (06/10--)

Seat Leon II / Toledo III / Altea (1P\_, 5P\_) (03/04--)

Skoda Octavia II (1Z\_) (02/04-06/13)

Skoda Superb II (3T) (03/08-05/15)

Volkswagen CC (11/11-12/16)

Volkswagen Eos (03/06-08/15)

Volkswagen Golf V (1K1, 1K5, 5M1) (10/03-08/14)

Volkswagen Jetta III (1K2) (09/04-12/13)

Volkswagen Passat (362, 365) (08/10-12/15)



Volkswagen Passat (3C\_) (03/05-01/12)

Volkswagen Passat (A32) (01/11--)

Volkswagen Sharan (7N) (05/10--)

Volkswagen Tiguan I (5N) (09/07-07/18)

Volkswagen Touran I (1T1/2/3) (02/03-05/15)

Rod/strut, suspension		116 035 0003	MSR0055
<b>Notes</b>  Guide Rod Lower Rear Axle Right Sheet Steel with rubber mount  Length [mm] 298 Paired article number 116 035 0002   MSR0054 Required quantity 1 replacement in pairs recommended			
<b>References</b> Audi 1K0 501 530 C Audi (FAW) 1K0 501 530 C Seat 1K0 501 530 C Seat 7N0 501 530 Skoda 1K0 501 530 C Volkswagen 1K0 501 530 B Volkswagen 1K0 501 530 C Volkswagen 7N0 501 530			
<b>Application info</b> Audi A3 II (8P_) (05/03-12/15) Audi Q3 I (8U_) (06/11-12/18) Audi TT II (8J_) (07/06-01/15) Seat Alhambra II (710) (06/10--) Seat Leon II / Toledo III / Altea (1P_ ,5P_) (03/04--) Skoda Octavia II (1Z_) (02/04-06/13) Skoda Superb II (3T) (03/08-05/15) Volkswagen CC (11/11-12/16) Volkswagen Eos (03/06-08/15) Volkswagen Golf V (1K1, 1K5, 5M1) (10/03-08/14) Volkswagen Jetta III (1K2) (09/04-12/13) Volkswagen Passat (362, 365) (08/10-12/15) Volkswagen Passat (3C_) (03/05-01/12) Volkswagen Passat (A32) (01/11--) Volkswagen Sharan (7N) (05/10--) Volkswagen Touran I (1T1/2/3) (02/03-05/15) Volkswagen Tiguan I (5N) (09/07-07/18)			
Rod/strut, suspension		116 035 0008	MSR0058
<b>Notes</b>  Aluminium Front Guide Rod Rear Axle Left Rear Axle Right Upper with rubber mount  Length [mm] 300 Required quantity 2 replacement in pairs recommended			



**References**

Audi 7L0 505 323 A  
Volkswagen 7L0 505 323 A

Porsche 955 331 047 10

**Application info**

Audi Q7 I (4L\_) (03/06-01/16)  
Porsche Cayenne II (92A) (06/10--)  
Volkswagen Touareg II (7P5) (01/10-12/18)

Porsche Cayenne I (955) (09/02-12/10)  
Volkswagen Touareg I (7LA, 7L6 ,7L7 ) (10/02-01/13)

**Rod/strut, suspension**

116 035 0012    MSR0060

**Notes**

Aluminium  
Guide Rod  
Rear  
Rear Axle Left  
with rubber mount  
Length [mm] 362  
Paired article number 116 035 0013 | MSR0061  
Required quantity 1

replacement in pairs recommended



**References**

Audi 8K0 505 323 D  
Audi 8K0 505 323 H  
Porsche 8K0 505 323 F

Audi 8K0 505 323 F  
Audi (FAW) 8KD 505 323 C

**Application info**

Audi A4 IV (8K\_) (08/07-05/16)  
Audi A6 IV (4G2, 4G5, C7) (11/10-09/18)  
Audi A8 III (4H\_) (11/09-01/18)  
Porsche Macan (95B) (02/14--)

Audi A5 I (8F\_ , 8T\_) (06/07-01/17)  
Audi A7 I Sportback (4G\_) (07/10-05/18)  
Audi Q5 I (8R\_) (11/08-12/17)

**Rod/strut, suspension**

116 035 0013    MSR0061

**Notes**

Aluminium  
Guide Rod  
Rear  
Rear Axle Right  
with rubber mount  
Length [mm] 362  
Paired article number 116 035 0012 | MSR0060  
Required quantity 1

replacement in pairs recommended



**References**

Audi 8K0 505 324 D  
 Audi 8K0 505 324 H  
 Porsche 8K0 505 324 F

Audi 8K0 505 324 F  
 Audi (FAW) 8KD 505 324 C

**Application info**

Audi A4 IV (8K\_) (08/07-05/16)  
 Audi A6 IV (4G2, 4G5, C7) (11/10-09/18)  
 Audi A8 III (4H\_) (11/09-01/18)  
 Porsche Macan (95B) (02/14--)

Audi A5 I (8F\_ , 8T\_) (06/07-01/17)  
 Audi A7 I Sportback (4G\_) (07/10-05/18)  
 Audi Q5 I (8R\_) (11/08-12/17)

**Rod/strut, suspension**

116 035 0015

MSR0115

**Notes**

Aluminium  
 Guide Rod  
 Rear Axle Left  
 with rubber mount  
 Length [mm] 282  
 Paired article number 116 035 0016 | MSR0116  
 Required quantity 1  
 replacement in pairs recommended

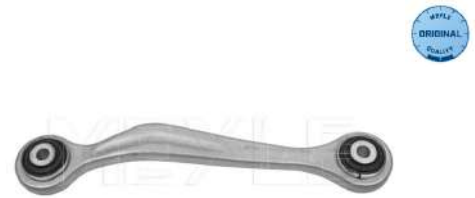

**References**

Audi 8K0 501 529 K  
 Audi (FAW) 8K0 501 529 N

Audi 8K0 501 529 N

**Application info**

Audi A4 IV (8K\_) (08/07-05/16)  
 Audi A6 IV (4G2, 4G5, C7) (11/10-09/18)  
 Audi A8 III (4H\_) (11/09-01/18)

Audi A5 I (8F\_ , 8T\_) (06/07-01/17)  
 Audi A7 I Sportback (4G\_) (07/10-05/18)  
 Audi Q5 I (8R\_) (11/08-12/17)

**Rod/strut, suspension**

116 035 0016

MSR0116

**Notes**

Aluminium  
 Guide Rod  
 Rear Axle Right  
 with rubber mount  
 Length [mm] 282  
 Paired article number 116 035 0015 | MSR0115  
 Required quantity 1  
 replacement in pairs recommended

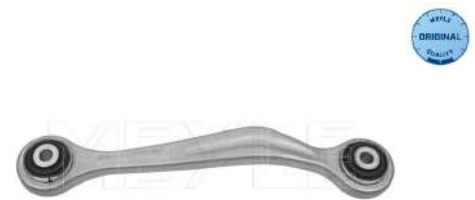

**References**

Audi 8K0 501 530 K

Audi (FAW) 8K0 501 530 N

Audi 8K0 501 530 N

**Application info**

Audi A4 IV (8K\_) (08/07-05/16)

Audi A6 IV (4G2, 4G5, C7) (11/10-09/18)

Audi A8 III (4H\_) (11/09-01/18)

Audi A5 I (8F\_ , 8T\_) (06/07-01/17)

Audi A7 I Sportback (4G\_) (07/10-05/18)

Audi Q5 I (8R\_) (11/08-12/17)

**Rod/strut, suspension****116 035 0020****MSR0120****Notes**

Guide Rod  
 Rear Axle Left  
 Rear Axle Right  
 Sheet Steel  
 with rubber mount

Length [mm]

306

Required quantity

2

replacement in pairs recommended

**References**

Audi 1K0 505 323 H

Audi 5Q0 505 323 C

Audi (FAW) 5Q0 505 323 C

Seat 1K0 505 323 H

Seat 5Q0 505 323 C

Skoda 1K0 505 323 H

Skoda 5Q0 505 323 C

Volkswagen 1K0 505 323 H

Volkswagen 1K0 505 323 P

Volkswagen 5Q0 505 323 D

Volkswagen (FAW) 5Q0 505 323 D

Audi 1K0 505 323 N

Audi 5Q0 505 323 D

CUPRA 5Q0505323C

Seat 1K0 505 323 N

Seat 5Q0 505 323 D

Skoda 1K0 505 323 N

Skoda 5Q0 505 323 D

Volkswagen 1K0 505 323 N

Volkswagen 5Q0 505 323 C

Volkswagen (FAW) 5Q0 505 323 C

**Application info**

Audi A1 I (8X_) (05/10-10/18)	Audi A3 II (8P_) (05/03-12/15)
Audi A3 III (8V_) (04/12--)	Audi A3 IV (8Y_) (11/19--)
Audi Q2 (06/16--)	Audi Q3 I (8U_) (06/11-12/18)
Audi Q3 II (F3_) (07/18--)	Audi TT II (8J_) (07/06-01/15)
Audi TT III (8S_) (07/14--)	CUPRA ATECA (KH7_KHP) (09/18--)
CUPRA FORMENTOR (KM_) (07/20--)	CUPRA LEON (KL_) (10/20--)
Seat Alhambra II (710) (06/10--)	Seat Ateca (04/16--)
Seat Leon II / Toledo III / Altea (1P_ ,5P_) (03/04--)	Seat Leon III (5F_) (09/12--)
Seat Leon IV (KL_) (11/19--)	Seat Tarraco (09/18--)
Skoda Karoq (07/17--)	Skoda Kodiaq I (10/16--)
Skoda Octavia II (1Z_) (02/04-06/13)	Skoda Octavia III (5E_) (11/12--)
Skoda Octavia IV (NX_) (11/19--)	Skoda Superb II (3T) (03/08-05/15)
Skoda Superb III (3V_) (03/15--)	Skoda Yeti (5L) (05/09-12/17)
Volkswagen Arteon (03/17--)	Volkswagen Beetle (5C1) (04/11-07/19)
Volkswagen CC (11/11-12/16)	Volkswagen Eos (03/06-08/15)
Volkswagen Golf V (1K1, 1K5, 5M1) (10/03-08/14)	Volkswagen Golf VI (5K1, 517, AJ5) (10/08-05/16)
Volkswagen Golf VII (5G1,BA5) (08/12--)	Volkswagen Golf VIII (CB1) (07/19--)
Volkswagen Jetta III (1K2) (09/04-12/13)	Volkswagen Jetta IV (162) (01/08--)
Volkswagen Jetta VII (BU3) (12/17--)	Volkswagen Passat (362, 365) (08/10-12/15)
Volkswagen Passat (3C_) (03/05-01/12)	Volkswagen Passat (A32) (01/11--)
Volkswagen Passat (B8) (08/14--)	Volkswagen Scirocco III (137) (05/08-11/17)
Volkswagen Sharan (7N) (05/10--)	Volkswagen T-Roc (A11) (07/17--)
Volkswagen Taos (CL1, CQ1) (10/20--)	Volkswagen Tiguan I (5N) (09/07-07/18)
Volkswagen Tiguan II (AD1, BW2) (01/16--)	Volkswagen Touran I (1T1/2/3) (02/03-05/15)
Volkswagen Touran II (5T1) (05/15--)	

**Rod/strut, suspension****116 035 0020/S****MSR0121****Notes**

Guide Rod  
Rear Axle Left  
Rear Axle Right  
Sheet Steel  
with accessories  
with rubber mount

Length [mm]

306

Required quantity

2

replacement in pairs recommended





**References**

Audi 1K0 505 323 H  
 Audi 5Q0 505 323 C  
 Audi (FAW) 5Q0 505 323 C  
 Seat 1K0 505 323 H  
 Seat 5Q0 505 323 C  
 Skoda 1K0 505 323 H  
 Skoda 5Q0 505 323 C  
 Volkswagen 1K0 505 323 H  
 Volkswagen 1K0 505 323 P  
 Volkswagen 5Q0 505 323 D  
 Volkswagen (FAW) 5Q0 505 323 D

**Application info**

Audi A1 I (8X\_) (05/10-10/18)  
 Audi A3 III (8V\_) (04/12--)  
 Audi Q2 (06/16--)  
 Audi Q3 II (F3\_) (07/18--)  
 Audi TT III (8S\_) (07/14--)  
 CUPRA FORMENTOR (KM\_) (07/20--)  
 Seat Alhambra II (710) (06/10--)  
 Seat Leon II / Toledo III / Altea (1P\_ ,5P\_) (03/04--)  
 Seat Leon IV (KL\_) (11/19--)  
 Skoda Karoq (07/17--)  
 Skoda Octavia II (1Z\_) (02/04-06/13)  
 Skoda Octavia IV (NX\_) (11/19--)  
 Skoda Superb III (3V\_) (03/15--)  
 Volkswagen Arteon (03/17--)  
 Volkswagen CC (11/11-12/16)  
 Volkswagen Golf V (1K1, 1K5, 5M1) (10/03-08/14)  
 Volkswagen Golf VII (5G1,BA5) (08/12--)  
 Volkswagen Jetta III (1K2) (09/04-12/13)  
 Volkswagen Jetta VII (BU3) (12/17--)  
 Volkswagen Passat (3C\_) (03/05-01/12)  
 Volkswagen Passat (B8) (08/14--)  
 Volkswagen Sharan (7N) (05/10--)  
 Volkswagen Taos (CL1, CQ1) (10/20--)  
 Volkswagen Tiguan II (AD1, BW2) (01/16--)  
 Volkswagen Touran II (5T1) (05/15--)  
 Audi A3 II (8P\_) (05/03-12/15)  
 Audi A3 IV (8Y\_) (11/19--)  
 Audi Q3 I (8U\_) (06/11-12/18)  
 Audi TT II (8J\_) (07/06-01/15)  
 CUPRA ATECA (KH7\_KHP) (09/18--)  
 CUPRA LEON (KL\_) (10/20--)  
 Seat Ateca (04/16--)  
 Seat Leon III (5F\_) (09/12--)  
 Seat Tarraco (09/18--)  
 Skoda Kodiaq I (10/16--)  
 Skoda Octavia III (5E\_) (11/12--)  
 Skoda Superb II (3T) (03/08-05/15)  
 Skoda Yeti (5L) (05/09-12/17)  
 Volkswagen Beetle (5C1) (04/11-07/19)  
 Volkswagen Eos (03/06-08/15)  
 Volkswagen Golf VI (5K1, 517, AJ5) (10/08-05/16)  
 Volkswagen Golf VIII (CB1) (07/19--)  
 Volkswagen Jetta IV (162) (01/08--)  
 Volkswagen Passat (362, 365) (08/10-12/15)  
 Volkswagen Passat (A32) (01/11--)  
 Volkswagen Scirocco III (137) (05/08-11/17)  
 Volkswagen T-Roc (A11) (07/17--)  
 Volkswagen Tiguan I (5N) (09/07-07/18)  
 Volkswagen Touran I (1T1/2/3) (02/03-05/15)

Rod/strut, suspension		116 050 0023	MSR0064
<b>Notes</b>  Guide Rod Rear Axle Left Steel  Paired article number 116 050 0024   MSR0065 Required quantity 1 Thread Size M14x1,5 replacement in pairs recommended			
<b>References</b> Audi 443 505 351 P			
<b>Application info</b> Audi 100 (4A, C4) (12/90-11/94)      Audi 100/200 (44, 44Q, C3) (08/82-12/91) Audi A6 I (4A, C4) (06/94-12/97)      Audi V8 (D1) (10/88-02/94)			
Rod/strut, suspension		116 050 0024	MSR0065
<b>Notes</b>  Guide Rod Rear Axle Right Steel  Paired article number 116 050 0023   MSR0064 Required quantity 1 Thread Size M14x1,5 replacement in pairs recommended			
<b>References</b> Audi 443 505 352 P			
<b>Application info</b> Audi 100 (4A, C4) (12/90-11/94)      Audi 100/200 (44, 44Q, C3) (08/82-12/91) Audi A6 I (4A, C4) (06/94-12/97)      Audi V8 (D1) (10/88-02/94)			

**Sleeve, control arm mount**

014 035 0034

MCX0034

**Notes**

	Rear Axle
	Steel
Inner Diameter [mm]	12
Length [mm]	17.9
Outer Diameter [mm]	13
Required quantity	2



**References**

Mercedes-Benz 210 352 00 43

Mercedes-Benz A 210 352 00 43

**Application info**

Chrysler Crossfire (07/03-12/08)	Mercedes-Benz BM 124 (12/84-12/93)
Mercedes-Benz BM 124 (E-Class) (02/93-03/98)	Mercedes-Benz BM 129 (SL) (03/89-09/04)
Mercedes-Benz BM 170 (SLK) (04/96-04/04)	Mercedes-Benz BM 171 (SLK) (03/04-12/11)
Mercedes-Benz BM 201 (190) (10/82-08/93)	Mercedes-Benz BM 202 (C-Class) (03/93-03/01)
Mercedes-Benz BM 203 (C-Class) (05/00-06/11)	Mercedes-Benz BM 208 (CLK) (06/97-12/03)
Mercedes-Benz BM 209 (CLK) (05/02-03/10)	Mercedes-Benz BM 210 (E-Class) (06/95-08/03)

**Sleeve, control arm mount**

100 399 0020

MCX0141

**Notes**

	Front Axle Left
	Front Axle Right
	Steel
Inner Diameter [mm]	13
Length [mm]	56
Outer Diameter [mm]	15
Required quantity	2



**References**

Audi 4A0 399 413 A

**Application info**

Audi 100 (4A, C4) (12/90-11/94)	Audi A6 I (4A, C4) (06/94-12/97)
---------------------------------	----------------------------------

Stabilizer link		016 035 0000/HD	MSL0003HD
<p><b>Notes</b></p> <p>Carbon Neutral Coupling Rod Front Axle Left Front Axle Right with spanner attachment</p> <p>Length [mm] 121 Required quantity 2 Thread Size 1 M10x1,5 Thread Size 2 M10x1,5 reinforced version replacement in pairs recommended</p>			
<p><b>References</b></p> <p>Smart 0005102V005 Smart 0005102V005000000 Smart 5102V005000000</p>			
<p><b>Application info</b></p> <p>Smart City Coupé / Cabrio (07/98-01/04) Smart Crossblade (06/02-12/03) Smart Fortwo I (01/04-02/07) Smart Roadster (04/03-11/05)</p>			

Stabilizer link		016 035 0056	MSL0987
<p><b>Notes</b></p> <p>Coupling Rod Rear Axle Right</p> <p>Length [mm] 318 Paired article number 016 035 0057   MSL0988 Required quantity 1 Thread Size 1 M10x1,5 Thread Size 2 M10x1,5 replacement in pairs recommended</p>			
<p><b>References</b></p> <p>Mercedes-Benz 222 320 04 89 Mercedes-Benz A 222 320 04 89</p>			
<p><b>Application info</b></p> <p>Mercedes-Benz BM 217 (S-Class) (12/15--) Mercedes-Benz BM 222 (S-Class) (05/13--)</p>			



**Stabilizer link****016 035 0057****MSL0988****Notes**

Coupling Rod  
Rear Axle Left

Length [mm] 318

Paired article number 016 035 0056 | MSL0987

Required quantity 1

Thread Size 1 M10x1,5

Thread Size 2 M10x1,5

replacement in pairs recommended

**References**

Mercedes-Benz 222 320 03 89

Mercedes-Benz A 222 320 03 89

**Application info**

Mercedes-Benz BM 217 (S-Class) (12/15--)

Mercedes-Benz BM 222 (S-Class) (05/13--)

**Stabilizer link****016 035 0058****MSL1000****Notes**

Coupling Rod  
Front Axle Right

Length [mm] 297

Paired article number 016 035 0059 | MSL1001

Required quantity 1

Thread Size 1 M12x1,5

Thread Size 2 M12x1,5

replacement in pairs recommended

**References**



Mercedes-Benz 253 323 02 17

Mercedes-Benz A 253 323 02 17

**Application info**

Mercedes-Benz BM 253 (GLC) (06/15--)

Mercedes-Benz BM 293 (EQC) (05/19--)

Stabilizer link		016 035 0059	MSL1001
<b>Notes</b>  Coupling Rod Front Axle Left  Length [mm] 297 Paired article number 016 035 0058   MSL1000 Required quantity 1 Thread Size 1 M12x1,5 Thread Size 2 M12x1,5 replacement in pairs recommended			
<b>References</b> Mercedes-Benz 253 323 01 17 Mercedes-Benz A 253 323 01 17			
<b>Application info</b> Mercedes-Benz BM 253 (GLC) (06/15--) Mercedes-Benz BM 293 (EQC) (05/19--)			
Stabilizer link		016 035 0060	MSL1002
<b>Notes</b>  Coupling Rod Front Axle Right  Length [mm] 292 Paired article number 016 035 0061   MSL1003 Required quantity 1 Thread Size 1 M12x1,5 Thread Size 2 M12x1,5 replacement in pairs recommended			
<b>References</b> Mercedes-Benz 205 323 10 17 Mercedes-Benz A 205 323 10 17			
<b>Application info</b> Mercedes-Benz BM 205 (C-Class) (12/13--) Mercedes-Benz BM 213 (E-Class) (01/16--) Mercedes-Benz BM 238 (E-Class) (06/17--) Mercedes-Benz BM 257 (CLS-Class) (12/17--)			

**Stabilizer link**

016 035 0061

MSL1003

**Notes**

Coupling Rod  
 Front Axle Left  
 Length [mm] 292  
 Paired article number 016 035 0060 | MSL1002  
 Required quantity 1  
 Thread Size 1 M12x1,5  
 Thread Size 2 M12x1,5  
 replacement in pairs recommended



**References**

Mercedes-Benz 205 323 09 17 Mercedes-Benz A 205 323 09 17  
 Trade number N/A

**Application info**

Mercedes-Benz BM 205 (C-Class) (12/13--)  
 Mercedes-Benz BM 238 (E-Class) (06/17--)  
 Mercedes-Benz BM 213 (E-Class) (01/16--)  
 Mercedes-Benz BM 257 (CLS-Class) (12/17--)

**Stabilizer link**

016 060 0001/HD

MSL0004HD

**Notes**

Carbon Neutral  
 Coupling Rod  
 Front Axle Left  
 Front Axle Right  
 with spanner attachment  
 Length [mm] 220  
 Required quantity 2  
 Thread Size 1 M10x1,5  
 Thread Size 2 M10x1,5  
 reinforced version  
 replacement in pairs recommended



**References**

Mercedes-Benz 168 320 03 89 Mercedes-Benz 168 320 05 89  
 Mercedes-Benz 168 320 07 89 Mercedes-Benz 168 320 10 89  
 Mercedes-Benz 168 320 11 89 Mercedes-Benz A 168 320 03 89  
 Mercedes-Benz A 168 320 05 89 Mercedes-Benz A 168 320 07 89  
 Mercedes-Benz A 168 320 10 89 Mercedes-Benz A 168 320 11 89

**Application info**

Mercedes-Benz BM 168 (A-Class) (07/97-08/05)

**Stabilizer link****016 060 0002/HD****MSL0005HD****Notes**

Carbon Neutral  
Coupling Rod  
Front Axle Left  
Front Axle Right  
with spanner attachment

Length [mm]

276

Required quantity

2

Thread Size 1

M10x1,5

Thread Size 2

M10x1,5

reinforced version

replacement in pairs recommended

**References**

Mercedes-Benz 203 320 04 89

Mercedes-Benz 203 320 25 89

Mercedes-Benz 203 320 28 89

Mercedes-Benz 203 320 38 89

Mercedes-Benz A 203 320 04 89

Mercedes-Benz A 203 320 25 89

Mercedes-Benz A 203 320 28 89

Mercedes-Benz A 203 320 38 89

**Application info**

Mercedes-Benz BM 203 (C-Class) (05/00-06/11)

Mercedes-Benz BM 209 (CLK) (05/02-03/10)

**Stabilizer link****016 060 0005/HD****MSL0008HD****Notes**

Carbon Neutral  
Coupling Rod  
Front Axle Left  
Front Axle Right  
with spanner attachment

Length [mm]

276

Required quantity

2

Thread Size 1

M12x1,5

Thread Size 2

M12x1,5

reinforced version

replacement in pairs recommended

**References**

Mercedes-Benz 203 320 21 89

Mercedes-Benz 203 320 26 89

Mercedes-Benz 203 320 29 89

Mercedes-Benz A 203 320 21 89

Mercedes-Benz A 203 320 26 89

Mercedes-Benz A 203 320 29 89

**Application info**

Mercedes-Benz BM 203 (C-Class) (05/00-06/11)

Mercedes-Benz BM 209 (CLK) (05/02-03/10)

**Stabilizer link**

016 060 0007

MSL0010

**Notes**

Coupling Rod  
Rear Axle Left  
Rear Axle Right

Length [mm] 259  
Pipe Diameter [mm] 10.5  
Required quantity 2  
Thread Size 1 M10x1,5  
replacement in pairs recommended



**References**

Mercedes-Benz 211 320 08 89  
Mercedes-Benz A 211 320 08 89  
Mercedes-Benz (BBDC) 211 320 33 89

Mercedes-Benz 211 320 33 89  
Mercedes-Benz A 211 320 33 89  
Mercedes-Benz (BBDC) A 211 320 33 89

**Application info**

Mercedes-Benz BM 211 (E-Class) (03/02-07/09)  
Mercedes-Benz BM 230 (SL) (10/01-01/12)

Mercedes-Benz BM 219 (CLS) (10/04-02/11)

**Stabilizer link**

016 060 0008

MSL0011

**Notes**

Coupling Rod  
Front Axle Left

Length [mm] 129  
Paired article number 016 060 0009 | MSL0012  
Required quantity 1  
replacement in pairs recommended



**References**



Mercedes-Benz 211 320 09 89  
Mercedes-Benz A 211 320 09 89  
Mercedes-Benz (BBDC) 211 320 39 89



Mercedes-Benz 211 320 39 89  
Mercedes-Benz A 211 320 39 89  
Mercedes-Benz (BBDC) A 211 320 39 89

**Application info**

Mercedes-Benz BM 211 (E-Class) (03/02-07/09)



Mercedes-Benz BM 219 (CLS) (10/04-02/11)

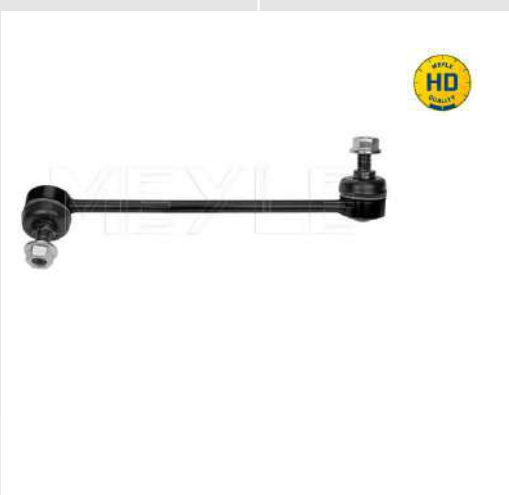
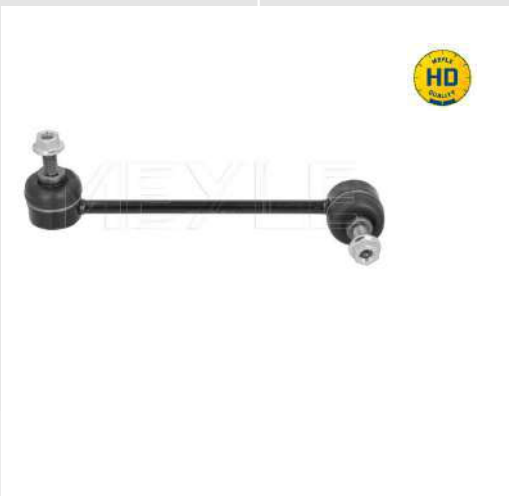

Stabilizer link		016 060 0009	MSL0012
<p><b>Notes</b></p> <p>Coupling Rod Front Axle Right</p> <p>Length [mm] 129</p> <p>Paired article number 016 060 0008   MSL0011</p> <p>Required quantity 1</p> <p>replacement in pairs recommended</p>			
<p><b>References</b></p> <p>Mercedes-Benz 211 320 10 89 Mercedes-Benz 211 320 38 89</p> <p>Mercedes-Benz A 211 320 10 89 Mercedes-Benz A 211 320 38 89</p> <p>Mercedes-Benz (BBDC) 211 320 38 89 Mercedes-Benz (BBDC) A 211 320 38 89</p>			
<p><b>Application info</b></p> <p>Mercedes-Benz BM 211 (E-Class) (03/02-07/09) Mercedes-Benz BM 219 (CLS) (10/04-02/11)</p>			
Stabilizer link		016 060 0010	MSL0013
<p><b>Notes</b></p> <p>Coupling Rod Front Axle Right for vehicles without electronic suspension control</p> <p>Inner Diameter [mm] 14</p> <p>Length [mm] 177</p> <p>Paired article number 016 060 0011   MSL0014</p> <p>Required quantity 1</p> <p>replacement in pairs recommended</p>			
<p><b>References</b></p> <p>Mercedes-Benz 220 320 15 89 Mercedes-Benz A 220 320 15 89</p>			
<p><b>Application info</b></p> <p>Mercedes-Benz BM 220 (S-Class) (09/98-08/05)</p>			

Stabilizer link		016 060 0011	MSL0014
<b>Notes</b>  Coupling Rod Front Axle Left Steel for vehicles without electronic suspension control  Inner Diameter [mm] 14 Length [mm] 177 Paired article number 016 060 0010   MSL0013 Required quantity 1 replacement in pairs recommended			
<b>References</b> Mercedes-Benz 220 320 16 89		Mercedes-Benz A 220 320 16 89	
<b>Application info</b> Mercedes-Benz BM 220 (S-Class) (09/98-08/05)			
Stabilizer link		016 060 0012/HD	MSL0701HD
<b>Notes</b>  Carbon Neutral Coupling Rod Front Axle Right with spanner attachment  Length [mm] 257 Paired article number 016 060 0013/HD   MSL0702HD Required quantity 1 Thread Size 1 M12x1,5 Thread Size 2 M12x1,5 reinforced version replacement in pairs recommended			
<b>References</b> Mercedes-Benz 172 323 02 17		Mercedes-Benz A 172 323 02 17	
<b>Application info</b> Mercedes-Benz BM 172 (SLC) (01/16--) Mercedes-Benz BM 172 (SLK) (01/11--)			

Stabilizer link		016 060 0013/HD	MSL0702HD
<b>Notes</b>  Carbon Neutral Coupling Rod Front Axle Left with spanner attachment  Length [mm] 257 Paired article number 016 060 0012/HD   MSL0701HD Required quantity 1 Thread Size 1 M12x1,5 Thread Size 2 M12x1,5 reinforced version replacement in pairs recommended			
<b>References</b> Mercedes-Benz 172 323 01 17 Mercedes-Benz A 172 323 01 17			
<b>Application info</b> Mercedes-Benz BM 172 (SLC) (01/16--) Mercedes-Benz BM 172 (SLK) (01/11--)			
Stabilizer link		016 060 0014/HD	MSL0015HD
<b>Notes</b>  Carbon Neutral Coupling Rod Front Axle Left Front Axle Right with spanner attachment  Length [mm] 207 Required quantity 2 Thread Size 1 M10x1,5 Thread Size 2 M10x1,5 reinforced version replacement in pairs recommended			
<b>References</b> Mercedes-Benz 414 320 01 89 Mercedes-Benz 414 320 03 89 Mercedes-Benz A 414 320 01 89 Mercedes-Benz A 414 320 03 89			
<b>Application info</b> Mercedes-Benz BM 414 (Vaneo) (02/02-07/05)			



Stabilizer link		016 060 0015/HD	MSL0016HD
<b>Notes</b>  Carbon Neutral Coupling Rod Front Axle Left with spanner attachment  Length [mm] 291 Paired article number 016 060 0016/HD   MSL0017HD Required quantity 1 Thread Size 1 M12x1,5 Thread Size 2 M12x1,5 reinforced version replacement in pairs recommended			
<b>References</b> Mercedes-Benz 221 320 15 89 Mercedes-Benz A 221 320 15 89			
<b>Application info</b> Mercedes-Benz BM 216 (S-Class) (05/06-12/13) Mercedes-Benz BM 221 (S-Class) (09/05-12/13)			
Stabilizer link		016 060 0016/HD	MSL0017HD
<b>Notes</b>  Carbon Neutral Coupling Rod Front Axle Right with spanner attachment  Length [mm] 291 Paired article number 016 060 0015/HD   MSL0016HD Required quantity 1 Thread Size 1 M12x1,5 Thread Size 2 M12x1,5 reinforced version replacement in pairs recommended			
<b>References</b> Mercedes-Benz 221 320 16 89 Mercedes-Benz A 221 320 16 89			
<b>Application info</b> Mercedes-Benz BM 216 (S-Class) (05/06-12/13) Mercedes-Benz BM 221 (S-Class) (09/05-12/13)			

Stabilizer link		016 060 0017/HD	MSL0018HD
<b>Notes</b>  Carbon Neutral Coupling Rod Front Axle Left with spanner attachment  Length [mm] 290 Paired article number 016 060 0018/HD   MSL0019HD Required quantity 1 Thread Size 1 M12x1,5 Thread Size 2 M12x1,5 reinforced version replacement in pairs recommended			
<b>References</b> Mercedes-Benz 204 320 07 89 Mercedes-Benz A 204 320 07 89 Mercedes-Benz (BBDC) 204 320 07 89 Mercedes-Benz (BBDC) A 204 320 07 89			
<b>Application info</b> Mercedes-Benz BM 204 (C-Class) (01/07--) Mercedes-Benz BM 207 (E-Class) (01/09-12/16) Mercedes-Benz BM 204 (GLK-Class) (06/08-12/15)			
Stabilizer link		016 060 0018/HD	MSL0019HD
<b>Notes</b>  Carbon Neutral Coupling Rod Front Axle Right with spanner attachment  Length [mm] 290 Paired article number 016 060 0017/HD   MSL0018HD Required quantity 1 Thread Size 1 M12x1,5 Thread Size 2 M12x1,5 reinforced version replacement in pairs recommended			
<b>References</b> Mercedes-Benz 204 320 22 89 Mercedes-Benz A 204 320 22 89 Mercedes-Benz (BBDC) 204 320 22 89 Mercedes-Benz (BBDC) A 204 320 22 89			
<b>Application info</b> Mercedes-Benz BM 204 (C-Class) (01/07--) Mercedes-Benz BM 207 (E-Class) (01/09-12/16) Mercedes-Benz BM 204 (GLK-Class) (06/08-12/15)			

**Stabilizer link** 016 060 0021/HD MSL0021HD

**Notes**

Carbon Neutral  
Coupling Rod  
Rear Axle Left  
Rear Axle Right  
with spanner attachment

Length [mm] 174  
Required quantity 2  
Thread Size M10x1,5  
reinforced version  
replacement in pairs recommended



**References**

Smart 0001802V004	Smart 0001802V004000000
Smart 01802V004000	Smart 1802V004000000

**Application info**

Smart City Coupé / Cabrio (07/98-01/04)	Smart Crossblade (06/02-12/03)
Smart Fortwo I (01/04-02/07)	Smart Roadster (04/03-11/05)

**Stabilizer link** 016 060 0024 MSL0024

**Notes**

Coupling Rod  
Front Axle Left  
Front Axle Right

Length [mm] 288  
Required quantity 2  
Thread Size 1 M10x1,5  
Thread Size 2 M12x1,75  
replacement in pairs recommended





**References**

Mercedes-Benz 203 320 18 89	Mercedes-Benz 203 320 30 89
Mercedes-Benz A 203 320 18 89	Mercedes-Benz A 203 320 30 89

**Application info**

Mercedes-Benz BM 203 (C-Class) (05/00-06/11)

Stabilizer link		016 060 0025	MSL0025
<b>Notes</b>  Coupling Rod Front Axle Left Front Axle Right  Length [mm] 244 Required quantity 2 Thread Size 1 M10x1,5 Thread Size 2 M10x1,5 replacement in pairs recommended			
<b>References</b> Mercedes-Benz 169 320 09 89 Mercedes-Benz 169 320 13 89 Mercedes-Benz A 169 320 09 89 Mercedes-Benz A 169 320 13 89			
<b>Application info</b> Mercedes-Benz BM 169 (A-Class) (09/04-06/12) Mercedes-Benz BM 245 (B-Class) (03/05-11/11)			
Stabilizer link		016 060 0027/HD	MSL0027HD
<b>Notes</b>  Carbon Neutral Coupling Rod Front Axle Left Front Axle Right with spanner attachment  Length [mm] 255 Required quantity 2 Thread Size 1 M12x1,5 Thread Size 2 M12x1,5 reinforced version replacement in pairs recommended			
<b>References</b> Mercedes-Benz 171 323 00 17 Mercedes-Benz A 171 323 00 17			
<b>Application info</b> Mercedes-Benz BM 171 (SLK) (03/04-12/11) Mercedes-Benz BM 204 (C-Class) (01/07-- )			

**Stabilizer link**

016 060 0029/HD

MSL0028HD

**Notes**

Carbon Neutral  
Coupling Rod  
Front Axle Left  
Front Axle Right  
with spanner attachment

Length [mm] 325  
Required quantity 2  
Thread Size 1 M10x1,5  
Thread Size 2 M10x1,5  
reinforced version  
replacement in pairs recommended

**References**

Smart 454 320 00 10

Smart A 454 320 00 10

**Application info**

Smart Forfour (01/04-06/06)

**Stabilizer link**

016 060 0030/HD

MSL0029HD

**Notes**

Carbon Neutral  
Coupling Rod  
Front Axle Left  
with spanner attachment

Length [mm] 280  
Paired article number 016 060 0031/HD | MSL0030HD  
Required quantity 1  
Thread Size 1 M12x1,5  
Thread Size 2 M12x1,5  
reinforced version  
replacement in pairs recommended

**References**

Mercedes-Benz 639 320 00 89

Mercedes-Benz 639 320 02 89

Mercedes-Benz 639 320 04 89



Mercedes-Benz A 639 320 00 89



Mercedes-Benz A 639 320 02 89

Mercedes-Benz A 639 320 04 89

**Application info**

Mercedes-Benz BM 639 (Vito / Viano) (08/03--)

Stabilizer link		016 060 0031/HD	MSL0030HD
<b>Notes</b>  Carbon Neutral Coupling Rod Front Axle Right with spanner attachment  Length [mm] 280 Paired article number 016 060 0030/HD   MSL0029HD Required quantity 1 Thread Size 1 M12x1,5 Thread Size 2 M12x1,5 reinforced version replacement in pairs recommended			
<b>References</b> Mercedes-Benz 639 320 01 89      Mercedes-Benz 639 320 03 89 Mercedes-Benz 639 320 05 89      Mercedes-Benz A 639 320 01 89 Mercedes-Benz A 639 320 03 89      Mercedes-Benz A 639 320 05 89			
<b>Application info</b> Mercedes-Benz BM 639 (Vito / Viano) (08/03--)			
Stabilizer link		016 060 0032	MSL0031
<b>Notes</b>  Coupling Rod Front Axle Left Front Axle Right  Length [mm] 205 Required quantity 2 Thread Size 1 M14x1,5 Thread Size 2 M14x1,5 replacement in pairs recommended			
<b>References</b> Mercedes-Benz 164 320 13 32      Mercedes-Benz 164 320 21 32 Mercedes-Benz 251 320 12 32      Mercedes-Benz A 164 320 13 32 Mercedes-Benz A 164 320 21 32      Mercedes-Benz A 251 320 12 32			
<b>Application info</b> Mercedes-Benz BM 164 (GL-Class) (09/06-12/12)      Mercedes-Benz BM 164 (M-Class) (02/05-12/12) Mercedes-Benz BM 251 (R-Class) (08/05-10/17)			

Stabilizer link		016 060 0033	MSL0032
<p><b>Notes</b></p> <p>Coupling Rod Rear Axle Left Rear Axle Right</p> <p>Length [mm] 117 Required quantity 2 Thread Size 1 M14x1,5 Thread Size 2 M14x1,5 replacement in pairs recommended</p>			
<p><b>References</b></p> <p>Mercedes-Benz 164 320 12 32 Mercedes-Benz A 164 320 12 32</p>			
<p><b>Application info</b></p> <p>Mercedes-Benz BM 164 (GL-Class) (09/06-12/12) Mercedes-Benz BM 164 (M-Class) (02/05-12/12)                      Mercedes-Benz BM 166 (GL) (07/12-12/15) Mercedes-Benz BM 166 (GLE) (03/15-10/19)                      Mercedes-Benz BM 166 (GLS) (11/15-04/19) Mercedes-Benz BM 166 (M-Class) (06/11-12/15)                      Mercedes-Benz BM 251 (R-Class) (08/05-10/17)</p>			
Stabilizer link		016 060 0034/HD	MSL0033HD
<p><b>Notes</b></p> <p>Carbon Neutral Coupling Rod Front Axle Left with spanner attachment</p> <p>Length [mm] 264 Paired article number 016 060 0035/HD   MSL0034HD Required quantity 1 Thread Size 1 M12x1,5 Thread Size 2 M12x1,5 reinforced version replacement in pairs recommended</p>			
<p><b>References</b></p> <p>Mercedes-Benz 221 320 01 89 Mercedes-Benz A 221 320 01 89</p>			
<p><b>Application info</b></p> <p>Mercedes-Benz BM 220 (S-Class) (09/98-08/05) Mercedes-Benz BM 221 (S-Class) (09/05-12/13)</p>			

## Stabilizer link

016 060 0035/HD

MSL0034HD

## Notes

Carbon Neutral  
Coupling Rod  
Front Axle Right  
with spanner attachment

Length [mm]

264

Paired article number

016 060 0034/HD | MSL0033HD

Required quantity

1

Thread Size 1

M12x1,5

Thread Size 2

M12x1,5

reinforced version

replacement in pairs recommended



## References

Mercedes-Benz 221 320 02 89

Mercedes-Benz A 221 320 02 89

## Application info

Mercedes-Benz BM 220 (S-Class) (09/98-08/05)

Mercedes-Benz BM 221 (S-Class) (09/05-12/13)

## Stabilizer link

016 060 0038

MSL0035

## Notes

Coupling Rod  
Front Axle Left

Length [mm]

138

Paired article number

016 060 0039 | MSL0036

Required quantity

1

Thread Size 1

M12x1,5

Thread Size 2

M12x1,5

replacement in pairs recommended



## References

Mercedes-Benz 906 320 17 89

Mercedes-Benz A 906 320 17 89

Volkswagen 2E0 411 317 C

## Application info

Mercedes-Benz BM 906 (Sprinter II) (06/06--)

Mercedes-Benz BM 907 / 910 (Sprinter III) (02/18--)

Volkswagen Crafter I (2E) (04/06-12/16)



**Stabilizer link**

016 060 0038/HD

MSL0035HD

**Notes**

Carbon Neutral  
Coupling Rod  
Front Axle Left

Length [mm] 138  
Paired article number 016 060 0039 | MSL0036  
Paired article number 016 060 0039/HD | MSL0036HD  
Required quantity 1  
Thread Size 1 M12x1,5  
Thread Size 2 M12x1,5  
reinforced version  
replacement in pairs recommended

**References**

Mercedes-Benz 906 320 17 89  
Volkswagen 2E0 411 317 C

Mercedes-Benz A 906 320 17 89

**Application info**

Mercedes-Benz BM 906 (Sprinter II) (06/06--)  
Volkswagen Crafter I (2E) (04/06-12/16)

Mercedes-Benz BM 907 / 910 (Sprinter III) (02/18--)

**Stabilizer link**

016 060 0039/HD

MSL0036HD

**Notes**

Carbon Neutral  
Coupling Rod  
Front Axle Right

Length [mm] 138  
Paired article number 016 060 0038/HD | MSL0035HD  
Required quantity 1  
Thread Size 1 M12x1,5  
Thread Size 2 M12x1,5  
reinforced version  
replacement in pairs recommended

**References**



Mercedes-Benz 906 320 18 89  
Volkswagen 2E0 411 318 C

Mercedes-Benz A 906 320 18 89

**Application info**

Mercedes-Benz BM 906 (Sprinter II) (06/06--)  
Volkswagen Crafter I (2E) (04/06-12/16)

Mercedes-Benz BM 907 / 910 (Sprinter III) (02/18--)

Stabilizer link		016 060 0039	MSL0036
<p><b>Notes</b></p> <p>Coupling Rod Front Axle Right</p> <p>Length [mm] 138</p> <p>Paired article number 016 060 0038   MSL0035</p> <p>Paired article number 016 060 0038/HD   MSL0035HD</p> <p>Required quantity 1</p> <p>Thread Size 1 M12x1,5</p> <p>Thread Size 2 M12x1,5</p> <p>replacement in pairs recommended</p>			
<p><b>References</b></p> <p>Mercedes-Benz 906 320 18 89</p> <p>Volkswagen 2E0 411 318 C</p>		<p>Mercedes-Benz A 906 320 18 89</p>	
<p><b>Application info</b></p> <p>Mercedes-Benz BM 906 (Sprinter II) (06/06--)</p> <p>Volkswagen Crafter I (2E) (04/06-12/16)</p>		<p>Mercedes-Benz BM 907 / 910 (Sprinter III) (02/18--)</p>	
Stabilizer link		016 060 0040/HD	MSL0037HD
<p><b>Notes</b></p> <p>Carbon Neutral Coupling Rod Front Axle Left Front Axle Right with spanner attachment</p> <p>Length [mm] 228</p> <p>Required quantity 2</p> <p>Thread Size 1 M10x1,5</p> <p>Thread Size 2 M10x1,5</p> <p>reinforced version</p> <p>replacement in pairs recommended</p>			
<p><b>References</b></p> <p>Smart 451 320 01 89</p>		<p>Smart A 451 320 01 89</p>	
<p><b>Application info</b></p> <p>Smart Fortwo II (01/07--)</p>			

**Stabilizer link**

016 060 0041/HD

MSL0038HD

**Notes**

Carbon Neutral  
Coupling Rod  
Front Axle Right  
with spanner attachment

Length [mm] 129  
Paired article number 016 060 0042/HD | MSL0039HD  
Required quantity 1  
Thread Size 1 M10x1,5  
Thread Size 2 M10x1,5  
reinforced version  
replacement in pairs recommended

**References**

Mercedes-Benz 905 320 05 89

Mercedes-Benz A 905 320 05 89

**Application info**

Mercedes-Benz BM 903 (Sprinter I) (01/95-05/12)

Mercedes-Benz BM 905 (Sprinter I) (04/01--)

**Stabilizer link**

016 060 0042/HD

MSL0039HD

**Notes**

Carbon Neutral  
Coupling Rod  
Front Axle Left  
with spanner attachment

Length [mm] 129  
Paired article number 016 060 0041/HD | MSL0038HD  
Required quantity 1  
Thread Size 1 M10x1,5  
Thread Size 2 M10x1,5  
reinforced version  
replacement in pairs recommended

**References**



Mercedes-Benz 905 320 04 89

Mercedes-Benz A 905 320 04 89

**Application info**

Mercedes-Benz BM 903 (Sprinter I) (01/95-05/12)

Mercedes-Benz BM 905 (Sprinter I) (04/01--)

Stabilizer link		016 060 0043	MSL0040
<b>Notes</b>  Coupling Rod Rear Axle Left Rear Axle Right  Inner Diameter 1 [mm] 12 Inner Diameter 2 [mm] 12 Length [mm] 140 Required quantity 2 replacement in pairs recommended			
<b>References</b> Mercedes-Benz 906 320 14 89 Mercedes-Benz A 906 320 14 89 Volkswagen 2E0 511 051 G			
<b>Application info</b> Mercedes-Benz BM 906 (Sprinter II) (06/06--) Volkswagen Crafter I (2E) (04/06-12/16)			
Stabilizer link		016 060 0044/HD	MSL0041HD
<b>Notes</b>  Carbon Neutral Coupling Rod Front Axle Left with spanner attachment  Length [mm] 307 Paired article number 016 060 0045/HD   MSL0042HD Required quantity 1 Thread Size 1 M12x1,5 Thread Size 2 M12x1,5 reinforced version replacement in pairs recommended			
<b>References</b> Mercedes-Benz 204 320 17 89 Mercedes-Benz 204 320 37 89 Mercedes-Benz A 204 320 17 89 Mercedes-Benz A 204 320 37 89 Mercedes-Benz (BBDC) 204 320 37 89 Mercedes-Benz (BBDC) A 204 320 37 89			
<b>Application info</b> Mercedes-Benz BM 204 (C-Class) (01/07--) Mercedes-Benz BM 207 (E-Class) (01/09-12/16)			

## Stabilizer link

016 060 0045/HD

MSL0042HD

## Notes

Carbon Neutral  
Coupling Rod  
Front Axle Right  
with spanner attachment

Length [mm] 307  
Paired article number 016 060 0044/HD | MSL0041HD  
Required quantity 1  
Thread Size 1 M12x1,5  
Thread Size 2 M12x1,5  
reinforced version  
replacement in pairs recommended



## References

Mercedes-Benz 204 320 18 89  
Mercedes-Benz A 204 320 18 89

Mercedes-Benz 204 320 38 89  
Mercedes-Benz A 204 320 38 89

## Application info

Mercedes-Benz BM 204 (C-Class) (01/07--)

Mercedes-Benz BM 207 (E-Class) (01/09-12/16)

## Stabilizer link

016 060 0046

MSL0043

## Notes

Coupling Rod  
Rear Axle Left

Length [mm] 233  
Paired article number 016 060 0047 | MSL0044  
Required quantity 1  
Thread Size 1 M10x1,5  
replacement in pairs recommended



## References



Mercedes-Benz 204 320 05 89  
Mercedes-Benz (BBDC) 204 320 05 89





Mercedes-Benz A 204 320 05 89  
Mercedes-Benz (BBDC) A 204 320 05 89



## Application info

Mercedes-Benz BM 204 (C-Class) (01/07--)  
Mercedes-Benz BM 207 (E-Class) (01/09-12/16)  
Mercedes-Benz BM 212 (E-Class) (01/09-12/16)

Mercedes-Benz BM 204 (GLK-Class) (06/08-12/15)  
Mercedes-Benz BM 211 (E-Class) (03/02-07/09)  
Mercedes-Benz BM 218 (CLS) (01/11-12/17)

Stabilizer link		016 060 0047	MSL0044
<b>Notes</b>  Coupling Rod Rear Axle Right  Length [mm] 233 Paired article number 016 060 0046   MSL0043 Required quantity 1 Thread Size 1 M10x1,5 replacement in pairs recommended			
<b>References</b> Mercedes-Benz 204 320 04 89 Mercedes-Benz A 204 320 04 89 Mercedes-Benz (BBDC) 204 320 04 89 Mercedes-Benz (BBDC) A 204 320 04 89			
<b>Application info</b> Mercedes-Benz BM 204 (C-Class) (01/07--) Mercedes-Benz BM 207 (E-Class) (01/09-12/16) Mercedes-Benz BM 212 (E-Class) (01/09-12/16)           Mercedes-Benz BM 204 (GLK-Class) (06/08-12/15) Mercedes-Benz BM 211 (E-Class) (03/02-07/09) Mercedes-Benz BM 218 (CLS) (01/11-12/17)			
Stabilizer link		016 060 0048/HD	MSL0045HD
<b>Notes</b>  Carbon Neutral Coupling Rod Front Axle Left with spanner attachment  Length [mm] 326 Paired article number 016 060 0049/HD   MSL0046HD Required quantity 1 Thread Size 1 M12x1,5 Thread Size 2 M12x1,5 reinforced version replacement in pairs recommended			
<b>References</b> Mercedes-Benz 212 320 11 89 Mercedes-Benz A 212 320 11 89 Mercedes-Benz (BBDC) 212 320 11 89 Mercedes-Benz (BBDC) A 212 320 11 89			
<b>Application info</b> Mercedes-Benz BM 212 (E-Class) (01/09-12/16) Mercedes-Benz BM 218 (CLS) (01/11-12/17)			

Stabilizer link		016 060 0049/HD	MSL0046HD
<p><b>Notes</b></p> <p>Carbon Neutral Coupling Rod Front Axle Right with spanner attachment</p> <p>Length [mm] 326 Paired article number 016 060 0048/HD   MSL0045HD Required quantity 1 Thread Size 1 M12x1,5 Thread Size 2 M12x1,5 reinforced version replacement in pairs recommended</p>		 	
<p><b>References</b></p> <p>Mercedes-Benz 212 320 12 89 Mercedes-Benz A 212 320 12 89 Mercedes-Benz (BBDC) 212 320 12 89 Mercedes-Benz (BBDC) A 212 320 12 89</p>			
<p><b>Application info</b></p> <p>Mercedes-Benz BM 212 (E-Class) (01/09-12/16) Mercedes-Benz BM 218 (CLS) (01/11-12/17)</p>			
Stabilizer link		016 060 0050/HD	MSL0047HD
<p><b>Notes</b></p> <p>Carbon Neutral Coupling Rod Front Axle Left with spanner attachment</p> <p>Length [mm] 275 Paired article number 016 060 0051/HD   MSL0048HD Required quantity 1 Thread Size 1 M12x1,5 Thread Size 2 M12x1,5 reinforced version replacement in pairs recommended</p>		 	
<p><b>References</b></p> <p>Mercedes-Benz 212 320 25 89 Mercedes-Benz A 212 320 25 89 Mercedes-Benz (BBDC) 212 320 25 89 Mercedes-Benz (BBDC) A 212 320 25 89</p>			
<p><b>Application info</b></p> <p>Mercedes-Benz BM 212 (E-Class) (01/09-12/16) Mercedes-Benz BM 218 (CLS) (01/11-12/17)</p>			

Stabilizer link		016 060 0051/HD	MSL0048HD
<b>Notes</b>  Carbon Neutral Coupling Rod Front Axle Right with spanner attachment  Length [mm] 275 Paired article number 016 060 0050/HD   MSL0047HD Required quantity 1 Thread Size 1 M12x1,5 Thread Size 2 M12x1,5 reinforced version replacement in pairs recommended			
<b>References</b> Mercedes-Benz 212 320 26 89 Mercedes-Benz A 212 320 26 89 Mercedes-Benz (BBDC) 212 320 26 89 Mercedes-Benz (BBDC) A 212 320 26 89			
<b>Application info</b> Mercedes-Benz BM 212 (E-Class) (01/09-12/16) Mercedes-Benz BM 218 (CLS) (01/11-12/17)			
Stabilizer link		016 060 0056	MSL0566
<b>Notes</b>  Coupling Rod Rear Axle Left Rear Axle Right with fastening material  Length [mm] 75 Required quantity 2 replacement in pairs recommended			
<b>References</b> Mercedes-Benz 246 320 01 00 Mercedes-Benz 246 320 04 89 Mercedes-Benz 246 320 07 89 Mercedes-Benz A 246 320 01 00 Mercedes-Benz A 246 320 04 89 Mercedes-Benz A 246 320 07 89 Mercedes-Benz (BBDC) 246 320 07 89 Mercedes-Benz (BBDC) A 246 320 07 89			
<b>Application info</b> Mercedes-Benz BM 117 (CLA) (01/13-03/19) Mercedes-Benz BM 156 (GLA-Class) (12/13--) Mercedes-Benz BM 176 (A-Class) (06/12-05/18) Mercedes-Benz BM 246 (B-Class) (10/11-12/18)			



**Stabilizer link****016 060 0057/HD****MSL0052HD****Notes**

Carbon Neutral  
Coupling Rod  
Front Axle Left  
Front Axle Right  
with spanner attachment

Length [mm]

332

Required quantity

2

Thread Size 1

M12x1,5

Thread Size 2

M12x1,5

reinforced version

replacement in pairs recommended

**References**

Mercedes-Benz 246 320 00 89

Mercedes-Benz A 246 320 00 89

Mercedes-Benz (BBDC) 246 320 06 89

Mercedes-Benz 246 320 06 89

Mercedes-Benz A 246 320 06 89

Mercedes-Benz (BBDC) A 246 320 06 89

**Application info**

Mercedes-Benz BM 117 (CLA) (01/13-03/19)

Mercedes-Benz BM 176 (A-Class) (06/12-05/18)

Mercedes-Benz BM 156 (GLA-Class) (12/13--)

Mercedes-Benz BM 246 (B-Class) (10/11-12/18)

**Stabilizer link****016 060 0065/HD****MSL0951HD****Notes**

Carbon Neutral  
Coupling Rod  
Front Axle Left

Length [mm]

325

Paired article number

016 060 0066/HD | MSL0952HD

Required quantity

1

Thread Size 1

M12x1,5

reinforced version

replacement in pairs recommended

**References**

Mercedes-Benz 166 320 07 89

Mercedes-Benz A 166 320 07 89

Mercedes-Benz 166 320 11 00

Mercedes-Benz A 166 320 11 00



**Application info**



Mercedes-Benz BM 166 (GL) (07/12-12/15)



Mercedes-Benz BM 166 (GLS) (11/15-04/19)



Mercedes-Benz BM 166 (GLE) (03/15-10/19)



Mercedes-Benz BM 166 (M-Class) (06/11-12/15)



Stabilizer link		016 060 0066/HD	MSL0952HD
<b>Notes</b>			
	Carbon Neutral		
	Coupling Rod		
	Front Axle Right		
Length [mm]	325		
Paired article number	016 060 0065/HD   MSL0951HD		
Required quantity	1		
Thread Size 1	M12x1,5		
reinforced version			
replacement in pairs recommended			
<b>References</b>			
Mercedes-Benz 166 320 08 89		Mercedes-Benz 166 320 12 00	
Mercedes-Benz A 166 320 08 89		Mercedes-Benz A 166 320 12 00	
<b>Application info</b>			
Mercedes-Benz BM 166 (GL) (07/12-12/15)		Mercedes-Benz BM 166 (GLE) (03/15-10/19)	
Mercedes-Benz BM 166 (GLS) (11/15-04/19)		Mercedes-Benz BM 166 (M-Class) (06/11-12/15)	
Stabilizer link		016 060 0067	MSL0710
<b>Notes</b>			
	Coupling Rod		
	Front Axle Left		
	Front Axle Right		
	with spanner attachment		
Length [mm]	276		
Required quantity	2		
Thread Size 1	M10x1,5		
Thread Size 2	M10x1,5		
replacement in pairs recommended			
<b>References</b>			
Mercedes-Benz 203 320 04 89		Mercedes-Benz 203 320 25 89	
Mercedes-Benz 203 320 28 89		Mercedes-Benz 203 320 38 89	
Mercedes-Benz A 203 320 04 89		Mercedes-Benz A 203 320 25 89	
Mercedes-Benz A 203 320 28 89		Mercedes-Benz A 203 320 38 89	
<b>Application info</b>			
Mercedes-Benz BM 203 (C-Class) (05/00-06/11)		Mercedes-Benz BM 209 (CLK) (05/02-03/10)	



Stabilizer link		016 060 0068	MSL0711
<b>Notes</b>  Coupling Rod Front Axle Left Front Axle Right with spanner attachment  Length [mm] 220 Required quantity 2 Thread Size 1 M10x1,5 Thread Size 2 M10x1,5 replacement in pairs recommended			
<b>References</b> Mercedes-Benz 168 320 03 89      Mercedes-Benz 168 320 05 89 Mercedes-Benz 168 320 07 89      Mercedes-Benz 168 320 10 89 Mercedes-Benz 168 320 11 89      Mercedes-Benz A 168 320 03 89 Mercedes-Benz A 168 320 05 89      Mercedes-Benz A 168 320 07 89 Mercedes-Benz A 168 320 10 89      Mercedes-Benz A 168 320 11 89			
<b>Application info</b> Mercedes-Benz BM 168 (A-Class) (07/97-08/05)			
Stabilizer link		016 060 0069	MSL0712
<b>Notes</b>  Coupling Rod Front Axle Left Front Axle Right with spanner attachment  Length [mm] 276 Required quantity 2 Thread Size 1 M12x1,5 Thread Size 2 M12x1,5 replacement in pairs recommended			
<b>References</b> Mercedes-Benz 203 320 21 89      Mercedes-Benz 203 320 26 89 Mercedes-Benz 203 320 29 89      Mercedes-Benz A 203 320 21 89 Mercedes-Benz A 203 320 26 89      Mercedes-Benz A 203 320 29 89			
<b>Application info</b> Mercedes-Benz BM 203 (C-Class) (05/00-06/11)      Mercedes-Benz BM 209 (CLK) (05/02-03/10)			

Stabilizer link		016 060 0070	MSL0713
<p><b>Notes</b></p> <p>Coupling Rod Front Axle Left Front Axle Right with spanner attachment</p> <p>Length [mm] 207 Required quantity 2 Thread Size 1 M10x1,5 Thread Size 2 M10x1,5 replacement in pairs recommended</p>			
<p><b>References</b></p> <p>Mercedes-Benz 414 320 01 89 Mercedes-Benz 414 320 03 89 Mercedes-Benz A 414 320 01 89 Mercedes-Benz A 414 320 03 89</p>			
<p><b>Application info</b></p> <p>Mercedes-Benz BM 414 (Vaneo) (02/02-07/05)</p>			
Stabilizer link		016 060 0071	MSL0714
<p><b>Notes</b></p> <p>Coupling Rod Front Axle Left with spanner attachment</p> <p>Length [mm] 290 Paired article number 016 060 0072   MSL0715 Required quantity 1 Thread Size 1 M12x1,5 Thread Size 2 M12x1,5 replacement in pairs recommended</p>			
<p><b>References</b></p> <p>Mercedes-Benz 204 320 07 89 Mercedes-Benz A 204 320 07 89 Mercedes-Benz (BBDC) 204 320 07 89 Mercedes-Benz (BBDC) A 204 320 07 89</p>			
<p><b>Application info</b></p> <p>Mercedes-Benz BM 204 (C-Class) (01/07--) Mercedes-Benz BM 207 (E-Class) (01/09-12/16)</p> <p>Mercedes-Benz BM 204 (GLK-Class) (06/08-12/15)</p>			



Stabilizer link		016 060 0072	MSL0715
<b>Notes</b>  Coupling Rod Front Axle Right with spanner attachment  Length [mm] 290 Paired article number 016 060 0071   MSL0714 Required quantity 1 Thread Size 1 M12x1,5 Thread Size 2 M12x1,5 replacement in pairs recommended			
<b>References</b> Mercedes-Benz 204 320 22 89 Mercedes-Benz A 204 320 22 89 Mercedes-Benz (BBDC) 204 320 22 89 Mercedes-Benz (BBDC) A 204 320 22 89			
<b>Application info</b> Mercedes-Benz BM 204 (C-Class) (01/07--) Mercedes-Benz BM 207 (E-Class) (01/09-12/16) Mercedes-Benz BM 204 (GLK-Class) (06/08-12/15)			
Stabilizer link		016 060 0076	MSL0719
<b>Notes</b>  Coupling Rod Front Axle Right with spanner attachment  Length [mm] 280 Paired article number 016 060 0077   MSL0720 Required quantity 1 Thread Size 1 M12x1,5 Thread Size 2 M12x1,5 replacement in pairs recommended			
<b>References</b> Mercedes-Benz 639 320 01 89 Mercedes-Benz 639 320 03 89 Mercedes-Benz 639 320 05 89 Mercedes-Benz A 639 320 01 89 Mercedes-Benz A 639 320 03 89 Mercedes-Benz A 639 320 05 89			
<b>Application info</b> Mercedes-Benz BM 639 (Vito / Viano) (08/03--)			



Stabilizer link		016 060 0077	MSL0720
<b>Notes</b>  Coupling Rod Front Axle Left with spanner attachment  Length [mm] 280 Paired article number 016 060 0076   MSL0719 Required quantity 1 Thread Size 1 M12x1,5 Thread Size 2 M12x1,5 replacement in pairs recommended			
<b>References</b> Mercedes-Benz 639 320 00 89 Mercedes-Benz 639 320 02 89 Mercedes-Benz 639 320 04 89 Mercedes-Benz A 639 320 00 89 Mercedes-Benz A 639 320 02 89 Mercedes-Benz A 639 320 04 89			
<b>Application info</b> Mercedes-Benz BM 639 (Vito / Viano) (08/03-- )			
Stabilizer link		016 060 0081	MSL0723
<b>Notes</b>  Coupling Rod Front Axle Left with spanner attachment  Length [mm] 307 Paired article number 016 060 0082   MSL0724 Required quantity 1 Thread Size 1 M12x1,5 Thread Size 2 M12x1,5 replacement in pairs recommended			
<b>References</b> Mercedes-Benz 204 320 37 89 Mercedes-Benz A 204 320 37 89 Mercedes-Benz (BBDC) 204 320 37 89 Mercedes-Benz (BBDC) A 204 320 37 89			
<b>Application info</b> Mercedes-Benz BM 204 (C-Class) (01/07-- ) Mercedes-Benz BM 207 (E-Class) (01/09-12/16)			



Stabilizer link		016 060 0082	MSL0724
<b>Notes</b>  Coupling Rod Front Axle Right with spanner attachment  Length [mm] 307 Paired article number 016 060 0081   MSL0723 Required quantity 1 Thread Size 1 M12x1,5 Thread Size 2 M12x1,5 replacement in pairs recommended			
<b>References</b> Mercedes-Benz 204 320 38 89 Mercedes-Benz (BBDC) 204 320 38 89		Mercedes-Benz A 204 320 38 89 Mercedes-Benz (BBDC) A 204 320 38 89	
<b>Application info</b> Mercedes-Benz BM 204 (C-Class) (01/07--) Mercedes-Benz BM 207 (E-Class) (01/09-12/16)			
Stabilizer link		016 060 0083	MSL0725
<b>Notes</b>  Coupling Rod Front Axle Left with spanner attachment  Length [mm] 307 Paired article number 016 060 0084   MSL0726 Required quantity 1 Thread Size 1 M12x1,5 Thread Size 2 M12x1,5 replacement in pairs recommended			
<b>References</b> Mercedes-Benz 204 320 17 89		Mercedes-Benz A 204 320 17 89	
<b>Application info</b> Mercedes-Benz BM 204 (C-Class) (01/07--) Mercedes-Benz BM 207 (E-Class) (01/09-12/16)			

Stabilizer link		016 060 0084	MSL0726
<b>Notes</b>  Coupling Rod Front Axle Right with spanner attachment  Length [mm] 307 Paired article number 016 060 0083   MSL0725 Required quantity 1 Thread Size 1 M12x1,5 Thread Size 2 M12x1,5 replacement in pairs recommended			
<b>References</b> Mercedes-Benz 204 320 18 89		Mercedes-Benz A 204 320 18 89	
<b>Application info</b> Mercedes-Benz BM 204 (C-Class) (01/07-- )		Mercedes-Benz BM 207 (E-Class) (01/09-12/16)	
Stabilizer link		016 060 0085	MSL0727
<b>Notes</b>  Coupling Rod Front Axle Left with spanner attachment  Length [mm] 326 Paired article number 016 060 0086   MSL0728 Required quantity 1 Thread Size 1 M12x1,5 Thread Size 2 M12x1,5 replacement in pairs recommended			
<b>References</b> Mercedes-Benz 212 320 11 89 Mercedes-Benz (BBDC) 212 320 11 89		Mercedes-Benz A 212 320 11 89 Mercedes-Benz (BBDC) A 212 320 11 89	
<b>Application info</b> Mercedes-Benz BM 212 (E-Class) (01/09-12/16)		Mercedes-Benz BM 218 (CLS) (01/11-12/17)	



Stabilizer link		016 060 0086	MSL0728
<b>Notes</b>  Coupling Rod Front Axle Right with spanner attachment  Length [mm] 326 Paired article number 016 060 0085   MSL0727 Required quantity 1 Thread Size 1 M12x1,5 Thread Size 2 M12x1,5 replacement in pairs recommended			
<b>References</b> Mercedes-Benz 212 320 12 89		Mercedes-Benz A 212 320 12 89	
<b>Application info</b> Mercedes-Benz BM 212 (E-Class) (01/09-12/16)		Mercedes-Benz BM 218 (CLS) (01/11-12/17)	
Stabilizer link		016 060 0087	MSL0729
<b>Notes</b>  Coupling Rod Front Axle Left with spanner attachment  Length [mm] 275 Paired article number 016 060 0088   MSL0730 Required quantity 1 Thread Size 1 M12x1,5 Thread Size 2 M12x1,5 replacement in pairs recommended			
<b>References</b> Mercedes-Benz 212 320 25 89 Mercedes-Benz (BBDC) 212 320 25 89		Mercedes-Benz A 212 320 25 89 Mercedes-Benz (BBDC) A 212 320 25 89	
<b>Application info</b> Mercedes-Benz BM 212 (E-Class) (01/09-12/16)		Mercedes-Benz BM 218 (CLS) (01/11-12/17)	

Stabilizer link		016 060 0088	MSL0730
<b>Notes</b>  Coupling Rod Front Axle Right with spanner attachment  Length [mm] 275 Paired article number 016 060 0087   MSL0729 Required quantity 1 Thread Size 1 M12x1,5 Thread Size 2 M12x1,5 replacement in pairs recommended			
<b>References</b> Mercedes-Benz 212 320 26 89 Mercedes-Benz A 212 320 26 89 Mercedes-Benz (BBDC) 212 320 26 89 Mercedes-Benz (BBDC) A 212 320 26 89			
<b>Application info</b> Mercedes-Benz BM 212 (E-Class) (01/09-12/16) Mercedes-Benz BM 218 (CLS) (01/11-12/17)			
Stabilizer link		016 060 0089	MSL0731
<b>Notes</b>  Coupling Rod Front Axle Left Front Axle Right with spanner attachment  Length [mm] 332 Required quantity 2 Thread Size 1 M12x1,5 Thread Size 2 M12x1,5 replacement in pairs recommended			
<b>References</b> Mercedes-Benz 246 320 00 89 Mercedes-Benz 246 320 06 89 Mercedes-Benz A 246 320 00 89 Mercedes-Benz A 246 320 06 89 Mercedes-Benz (BBDC) 246 320 06 89 Mercedes-Benz (BBDC) A 246 320 06 89			
<b>Application info</b> Mercedes-Benz BM 117 (CLA) (01/13-03/19) Mercedes-Benz BM 156 (GLA-Class) (12/13--) Mercedes-Benz BM 176 (A-Class) (06/12-05/18) Mercedes-Benz BM 246 (B-Class) (10/11-12/18)			

Stabilizer link		016 060 0093	MSL0989
<p><b>Notes</b></p> <p>Coupling Rod Rear Axle Left</p> <p>Length [mm] 233</p> <p>Paired article number 016 060 0094   MSL0990</p> <p>Required quantity 1</p> <p>replacement in pairs recommended</p>			
<p><b>References</b></p> <p>Mercedes-Benz 205 326 03 17 Mercedes-Benz A 205 326 03 17</p>			
<p><b>Application info</b></p> <p>Mercedes-Benz BM 205 (C-Class) (12/13--)</p> <p>Mercedes-Benz BM 238 (E-Class) (06/17--)</p> <p>Mercedes-Benz BM 257 (CLS-Class) (12/17--)</p> <p>Mercedes-Benz BM 213 (E-Class) (01/16--)</p> <p>Mercedes-Benz BM 253 (GLC) (06/15--)</p> <p>Mercedes-Benz BM 293 (EQC) (05/19--)</p>			
Stabilizer link		016 060 0094	MSL0990
<p><b>Notes</b></p> <p>Coupling Rod Rear Axle Right</p> <p>Length [mm] 233</p> <p>Paired article number 016 060 0093   MSL0989</p> <p>Required quantity 1</p> <p>replacement in pairs recommended</p>			
<p><b>References</b></p> <p>Mercedes-Benz 205 326 04 17 Mercedes-Benz A 205 326 04 17</p> <p>Mercedes-Benz (BBDC) 205 326 04 17 Mercedes-Benz (BBDC) A 205 326 04 17</p>			
<p><b>Application info</b></p> <p>Mercedes-Benz BM 205 (C-Class) (12/13--)</p> <p>Mercedes-Benz BM 238 (E-Class) (06/17--)</p> <p>Mercedes-Benz BM 257 (CLS-Class) (12/17--)</p> <p>Mercedes-Benz BM 213 (E-Class) (01/16--)</p> <p>Mercedes-Benz BM 253 (GLC) (06/15--)</p> <p>Mercedes-Benz BM 293 (EQC) (05/19--)</p>			

**Stabilizer link**

016 060 0097/HD

MSL0974HD

**Notes**

Carbon Neutral  
 Front Axle Left  
 Suspension Rod

Length [mm] 325  
 Paired article number 016 060 0098/HD | MSL0975HD  
 Pipe Diameter [mm] 12  
 Required quantity 1  
 Thread Size 1 M10x1,5  
 Thread Size 2 M12x1,5  
 reinforced version  
 replacement in pairs recommended

**References**

Mercedes-Benz 222 320 11 89

Mercedes-Benz A 222 320 11 89

**Application info**

Mercedes-Benz BM 222 (S-Class) (05/13--)

**Stabilizer link**

016 060 0098/HD

MSL0975HD

**Notes**

Carbon Neutral  
 Front Axle Right  
 Suspension Rod

Length [mm] 325  
 Paired article number 016 060 0097/HD | MSL0974HD  
 Pipe Diameter [mm] 12  
 Required quantity 1  
 Thread Size 1 M10x1,5  
 Thread Size 2 M12x1,5  
 reinforced version  
 replacement in pairs recommended



**References**

Mercedes-Benz 222 320 10 89

Mercedes-Benz A 222 320 10 89

**Application info**

Mercedes-Benz BM 222 (S-Class) (05/13--)

Stabilizer link		016 060 0099/HD	MSL0913HD
<b>Notes</b>  Carbon Neutral Coupling Rod Front Axle Left with spanner attachment  Length [mm] 363 Paired article number 016 060 0100/HD   MSL0914HD Required quantity 1 Thread Size 1 M12x1.5 Thread Size 2 M12x1.5 reinforced version replacement in pairs recommended			
<b>References</b> Mercedes-Benz 447 320 00 89 Mercedes-Benz A 447 320 00 89			
<b>Application info</b> Mercedes-Benz BM 447 (V-Class) (03/14--) Mercedes-Benz BM 447 (Vito) (10/14--)			
Stabilizer link		016 060 0100/HD	MSL0914HD
<b>Notes</b>  Carbon Neutral Coupling Rod Front Axle Right with spanner attachment  Length [mm] 363 Paired article number 016 060 0099/HD   MSL0913HD Required quantity 1 Thread Size 1 M12x1,5 Thread Size 2 M12x1,5 reinforced version replacement in pairs recommended			
<b>References</b> Mercedes-Benz 447 320 03 89 Mercedes-Benz A 447 320 03 89			
<b>Application info</b> Mercedes-Benz BM 447 (V-Class) (03/14--) Mercedes-Benz BM 447 (Vito) (10/14--)			

**Stabilizer link**

016 060 0101/HD

MSL0915HD

**Notes**

Carbon Neutral  
Coupling Rod  
Front Axle Left  
with spanner attachment

Length [mm]

347

Paired article number

016 060 0102/HD | MSL0916HD

Required quantity

1

Thread Size 1

M12x1.5

Thread Size 2

M12x1,5

reinforced version

replacement in pairs recommended

**References**

Mercedes-Benz 447 320 01 89

Mercedes-Benz A 447 320 01 89

**Application info**

Mercedes-Benz BM 447 (V-Class) (03/14--)

Mercedes-Benz BM 447 (Vito) (10/14--)

**Stabilizer link**

016 060 0102/HD

MSL0916HD

**Notes**

Carbon Neutral  
Coupling Rod  
Front Axle Right  
with spanner attachment

Length [mm]

347

Paired article number

016 060 0101/HD | MSL0915HD

Required quantity

1

Thread Size 1

M12x1,5

Thread Size 2

M12x1,5

reinforced version

replacement in pairs recommended

**References**

Mercedes-Benz 447 320 02 89

Mercedes-Benz A 447 320 02 89

**Application info**

Mercedes-Benz BM 447 (V-Class) (03/14--)

Mercedes-Benz BM 447 (Vito) (10/14--)

**Stabilizer link**

016 060 0103/HD

MSL0917HD

**Notes**

Carbon Neutral  
Coupling Rod  
Front Axle Left  
Front Axle Right  
with spanner attachment

Length [mm]

316

Required quantity

2

Thread Size 1

M12x1.5

Thread Size 2

M12x1,5

reinforced version

replacement in pairs recommended

**References**

Mercedes-Benz 447 320 04 89

Mercedes-Benz A 447 320 04 89

**Application info**

Mercedes-Benz BM 447 (V-Class) (03/14--)

Mercedes-Benz BM 447 (Vito) (10/14--)

**Stabilizer link**

016 060 0104/HD

MSL0899HD

**Notes**

Carbon Neutral  
Coupling Rod  
Front Axle Right  
with spanner attachment

Length [mm]

297

Paired article number

016 060 0105/HD | MSL0918HD

Required quantity

1

Thread Size 1

M12x1.5

Thread Size 2

M12x1,5

reinforced version

replacement in pairs recommended

**References**

Mercedes-Benz 639 320 08 89

Mercedes-Benz A 639 320 08 89

**Application info**

Mercedes-Benz BM 639 (Vito / Viano) (08/03--)

**Stabilizer link**

016 060 0105/HD

MSL0918HD

**Notes**

Carbon Neutral  
Coupling Rod  
Front Axle Left  
with spanner attachment

Length [mm] 297  
Paired article number 016 060 0104/HD | MSL0899HD  
Required quantity 1  
Thread Size 1 M12x1.5  
Thread Size 2 M12x1,5  
reinforced version  
replacement in pairs recommended

**References**

Mercedes-Benz 639 320 07 89

Mercedes-Benz A 639 320 07 89

**Application info**

Mercedes-Benz BM 639 (Vito / Viano) (08/03--)

**Stabilizer link**

016 060 0106/HD

MSL0919HD

**Notes**

Carbon Neutral  
Coupling Rod  
Front Axle Right  
with spanner attachment

Length [mm] 285  
Paired article number 016 060 0107/HD | MSL0920HD  
Required quantity 1  
Thread Size 1 M12x1.5  
Thread Size 2 M12x1.5  
reinforced version  
replacement in pairs recommended

**References**

Mercedes-Benz 639 320 10 89

Mercedes-Benz A 639 320 10 89

**Application info**

Mercedes-Benz BM 639 (Vito / Viano) (08/03--)



**Stabilizer link**

016 060 0107/HD

MSL0920HD

**Notes**

Carbon Neutral  
Coupling Rod  
Front Axle Left  
with spanner attachment

Length [mm] 285  
Paired article number 016 060 0106/HD | MSL0919HD  
Required quantity 1  
Thread Size 1 M12x1.5  
Thread Size 2 M12x1,5  
reinforced version  
replacement in pairs recommended

**References**

Mercedes-Benz 639 320 09 89

Mercedes-Benz A 639 320 09 89

**Application info**

Mercedes-Benz BM 639 (Vito / Viano) (08/03--)

**Stabilizer link**

016 060 0108/HD

MSL0965HD

**Notes**

Carbon Neutral  
Coupling Rod  
Front Axle Right

Length [mm] 310  
Paired article number 016 060 0108  
Paired article number 016 060 0109/HD | MSL0966HD  
Pipe Diameter [mm] 10  
Required quantity 1  
Thread Size 1 M10x1,5  
Thread Size 2 M12x1,5  
reinforced version  
replacement in pairs recommended

**References**



Mercedes-Benz 222 320 16 89

Mercedes-Benz A 222 320 16 89

**Application info**

Mercedes-Benz BM 217 (S-Class) (12/15--)

Mercedes-Benz BM 222 (S-Class) (05/13--)

Stabilizer link		016 060 0109/HD	MSL0966HD
<p><b>Notes</b></p> <p>Carbon Neutral Coupling Rod Front Axle Left</p> <p>Length [mm] 310 Paired article number 016 060 0108/HD   MSL0965HD Pipe Diameter [mm] 10 Required quantity 1 Thread Size 1 M10x1,5 Thread Size 2 M12x1,5 reinforced version replacement in pairs recommended</p>			
<p><b>References</b></p> <p>Mercedes-Benz 222 320 17 89 Mercedes-Benz A 222 320 17 89</p>			
<p><b>Application info</b></p> <p>Mercedes-Benz BM 217 (S-Class) (12/15--) Mercedes-Benz BM 222 (S-Class) (05/13--)</p>			
Stabilizer link		016 060 0110	MSL0976
<p><b>Notes</b></p> <p>Coupling Rod Rear Axle Left Rear Axle Right</p> <p>Length [mm] 145 Pipe Diameter [mm] 10 Required quantity 2 replacement in pairs recommended</p>			
<p><b>References</b></p> <p>MERCEDES-BENZ (FJDA) 639 326 06 16 MERCEDES-BENZ (FJDA) A 639 326 06 16 Mercedes-Benz 639 326 06 16 Mercedes-Benz A 639 326 06 16</p>			
<p><b>Application info</b></p> <p>Mercedes-Benz BM 447 (V-Class) (03/14--) Mercedes-Benz BM 639 (Vito / Viano) (08/03--) Mercedes-Benz BM 447 (Vito) (10/14--)</p>			

**Stabilizer link****016 060 0111/HD****MSL1005HD****Notes**

Carbon Neutral  
Coupling Rod  
Front Axle Left

Length [mm] 285

Paired article number 016 060 0112/HD | MSL1006HD

Required quantity 1

Thread Size 1 M12x1,5

Thread Size 2 M12x1,5

reinforced version

replacement in pairs recommended

**References**

Mercedes-Benz 910 320 30 00

Mercedes-Benz A 910 320 30 00

**Application info**

Mercedes-Benz BM 907 / 910 (Sprinter III) (02/18--)

**Stabilizer link****016 060 0112/HD****MSL1006HD****Notes**

Carbon Neutral  
Coupling Rod  
Front Axle Right

Length [mm] 285

Paired article number 016 060 0111/HD | MSL1005HD

Required quantity 1

Thread Size 1 M12x1,5

Thread Size 2 M12x1,5

reinforced version

replacement in pairs recommended

**References**

Mercedes-Benz 910 320 31 00

Mercedes-Benz A 910 320 31 00

Trade number 1000068

**Application info**

Mercedes-Benz BM 907 / 910 (Sprinter III) (02/18--)

**Stabilizer link** **016 060 0114/HD** **MSL1066HD**

**Notes**

	Carbon Neutral
	Coupling Rod
	Front Axle Left
	Front Axle Right
Length [mm]	339
Required quantity	2
Thread Size 1	M12x1,5
Thread Size 2	M12x1,5
reinforced version	
replacement in pairs recommended	



**References**

Mercedes-Benz 247 320 42 00	Mercedes-Benz 247 320 75 03
Mercedes-Benz 247 320 76 03	Mercedes-Benz A 247 320 42 00
Mercedes-Benz A 247 320 75 03	Mercedes-Benz A 247 320 76 03
Mercedes-Benz (BBDC) 247 320 42 00	Mercedes-Benz (BBDC) 247 320 76 03
Mercedes-Benz (BBDC) A 247 320 42 00	Mercedes-Benz (BBDC) A 247 320 76 03

**Application info**

Mercedes-Benz BM 118 (CLA) (03/19--)	Mercedes-Benz BM 177 (A-Class) (03/18--)
Mercedes-Benz BM 243 (EQA) (02/21--)	Mercedes-Benz BM 243 (EQB) (12/21--)
Mercedes-Benz BM 247 (B-Class) (12/18--)	Mercedes-Benz BM 247 (GLA-Class) (02/20--)
Mercedes-Benz BM 247 (GLB-Class) (08/19--)	

**Stabilizer link** **016 060 0115/HD** **MSL1094HD**

**Notes**

	Carbon Neutral
	Coupling Rod
	Front Axle Left
Length [mm]	327.2
Paired article number	016 060 0116/HD   MSL1095HD
Required quantity	1
Thread Size 1	M12x1,5
reinforced version	
replacement in pairs recommended	



**References**

Mercedes-Benz 167 320 01 89	Mercedes-Benz 167 320 55 04
Mercedes-Benz A 167 320 01 89	Mercedes-Benz A 167 320 55 04

**Application info**

Mercedes-Benz BM 167 (GLE) (10/18--)

Mercedes-Benz BM 167 (GLS) (04/19--)

**Stabilizer link**

016 060 0116/HD

MSL1095HD

**Notes**

Carbon Neutral  
Coupling Rod  
Front Axle Right

Length [mm] 327.2  
Paired article number 016 060 0115/HD | MSL1094HD  
Required quantity 1  
Thread Size 1 M12x1,5  
reinforced version  
replacement in pairs recommended



**References**

Mercedes-Benz 167 320 02 89  
Mercedes-Benz A 167 320 02 89

Mercedes-Benz 167 320 56 04  
Mercedes-Benz A 167 320 56 04

**Application info**

Mercedes-Benz BM 167 (GLE) (10/18--)

Mercedes-Benz BM 167 (GLS) (04/19--)

**Stabilizer link**

016 060 0117/HD

MSL1149HD

**Notes**

Carbon Neutral  
Coupling Rod  
Rear Axle Left  
Steel

Inner Diameter [mm] 14.2  
Length [mm] 124  
Paired article number 016 060 0118/HD | MSL1150HD  
Pipe Diameter [mm] 10  
Required quantity 1  
Thread Size 1 M14x1,5  
reinforced version  
replacement in pairs recommended



**References**

Mercedes-Benz 167 320 31 04  
Mercedes-Benz A 167 320 31 04

Mercedes-Benz 167 320 87 00  
Mercedes-Benz A 167 320 87 00

**Application info**

Mercedes-Benz BM 167 (GLE) (10/18--)

Mercedes-Benz BM 167 (GLS) (04/19--)

**Stabilizer link**

016 060 0118/HD

MSL1150HD

**Notes**

Carbon Neutral  
Coupling Rod  
Rear Axle Right  
Steel

Inner Diameter [mm] 14.2  
Length [mm] 124  
Paired article number 016 060 0117/HD | MSL1149HD  
Pipe Diameter [mm] 10  
Required quantity 1  
Thread Size 1 M14x1,5  
reinforced version  
replacement in pairs recommended

**References**

Mercedes-Benz 167 320 32 04  
Mercedes-Benz A 167 320 32 04

Mercedes-Benz 167 320 88 00  
Mercedes-Benz A 167 320 88 00

**Application info**

Mercedes-Benz BM 167 (GLE) (10/18--)

Mercedes-Benz BM 167 (GLS) (04/19--)

**Stabilizer link**

016 060 0119/HD

MSL1085HD

**Notes**

Carbon Neutral  
Coupling Rod  
Front Axle Left  
Front Axle Right

Length [mm] 202  
Required quantity 2  
Thread Size 1 10x1,25  
Thread Size 2 10x1,25  
reinforced version  
replacement in pairs recommended

**References**

Renault 546181179R  
Smart A 453 320 00 89

Smart 453 320 00 89

**Application info**

Renault Twingo III (09/14--)  
Smart Fortwo III (07/14--)

Smart Forfour II (07/14--)

**Stabilizer link****016 060 0126/HD****MSL1166HD****Notes**

Carbon Neutral  
Coupling Rod  
Front Axle Right

Length [mm] 137  
Paired article number 016 060 0127/HD | MSL1167HD  
Pipe Diameter [mm] 10  
Required quantity 1  
Thread Size 1 M12x1,5  
Thread Size 2 M12x1,5  
reinforced version  
replacement in pairs recommended

**References**

Mercedes-Benz 906 320 20 89

Mercedes-Benz A 906 320 20 89

**Application info**

Mercedes-Benz BM 906 (Sprinter II) (06/06--)

Mercedes-Benz BM 907 / 910 (Sprinter III) (02/18--)

**Stabilizer link****016 060 0127/HD****MSL1167HD****Notes**

Carbon Neutral  
Coupling Rod  
Front Axle Left

Length [mm] 137  
Paired article number 016 060 0126/HD | MSL1166HD  
Pipe Diameter [mm] 10  
Required quantity 1  
Thread Size 1 M12x1,5  
Thread Size 2 M12x1,5  
reinforced version  
replacement in pairs recommended

**References**



Mercedes-Benz 906 320 19 89

Mercedes-Benz A 906 320 19 89

**Application info**

Mercedes-Benz BM 906 (Sprinter II) (06/06--)

Mercedes-Benz BM 907 / 910 (Sprinter III) (02/18--)

Stabilizer link		016 060 0134/HD	MSL1193HD
<p><b>Notes</b></p> <p>Coupling Rod Front Axle Left</p> <p>Length [mm] 290</p> <p>Paired article number 016 060 0135/HD   MSL1194HD</p> <p>Required quantity 1</p> <p>Thread Size 1 M12x1,5</p> <p>Thread Size 2 M12x1,5</p> <p>replacement in pairs recommended</p>			
<p><b>References</b></p> <p>Mercedes-Benz 297 320 05 00 Mercedes-Benz 297 323 29 00</p> <p>Mercedes-Benz A 297 320 05 00 Mercedes-Benz A 297 320 29 00</p>			
<p><b>Application info</b></p> <p>Mercedes-Benz BM 294 (EQE SUV) (12/22--)</p> <p>Mercedes-Benz BM 297 (EQS) (08/21--)</p> <p>Mercedes-Benz BM 295 (EQE) (02/22--)</p>			
Stabilizer link		016 060 0135/HD	MSL1194HD
<p><b>Notes</b></p> <p>Coupling Rod Front Axle Right</p> <p>Length [mm] 290</p> <p>Paired article number 016 060 0134/HD   MSL1193HD</p> <p>Required quantity 1</p> <p>Thread Size 1 M12x1,5</p> <p>Thread Size 2 M12x1,5</p> <p>replacement in pairs recommended</p>			
<p><b>References</b></p> <p>Mercedes-Benz 297 320 06 00 Mercedes-Benz 297 323 30 00</p> <p>Mercedes-Benz A 297 320 06 00 Mercedes-Benz A 297 323 30 00</p>			
<p><b>Application info</b></p> <p>Mercedes-Benz BM 294 (EQE SUV) (12/22--)</p> <p>Mercedes-Benz BM 297 (EQS) (08/21--)</p> <p>Mercedes-Benz BM 295 (EQE) (02/22--)</p>			

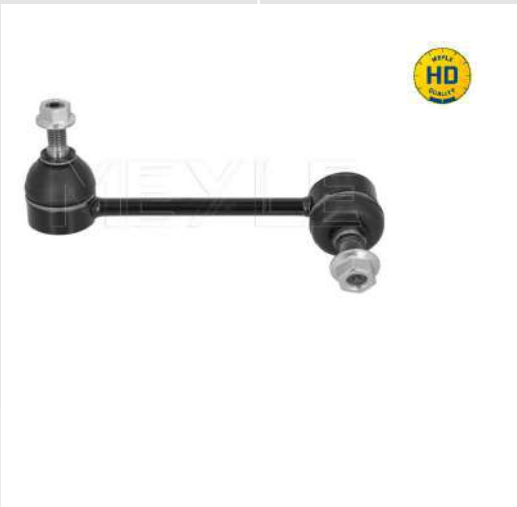

Stabilizer link		016 060 0226	MSL0057
<p><b>Notes</b></p> <p>Coupling Rod Rear Axle Left Rear Axle Right</p> <p>Length [mm] 230 Required quantity 2 Thread Size 1 M10x1,5 Thread Size 2 M10x1,5 replacement in pairs recommended</p>			
<p><b>References</b></p> <p>Mercedes-Benz 140 320 08 89 Mercedes-Benz 140 320 35 89 Mercedes-Benz 220 320 36 89 Mercedes-Benz A 140 320 08 89 Mercedes-Benz A 140 320 35 89 Mercedes-Benz A 220 320 36 89</p>			
<p><b>Application info</b></p> <p>Mercedes-Benz BM 140 (S-Class) (02/91-12/99) Mercedes-Benz BM 220 (S-Class) (09/98-08/05)</p>			
Stabilizer link		016 060 6318/HD	MSL0058HD
<p><b>Notes</b></p> <p>Carbon Neutral Coupling Rod Front Axle Left with spanner attachment</p> <p>Length [mm] 152 Paired article number 016 060 6319/HD   MSL0059HD Required quantity 1 Thread Size 1 M12x1,5 Thread Size 2 M10x1,5 reinforced version replacement in pairs recommended</p>			
<p><b>References</b></p> <p>Mercedes-Benz 140 320 11 89 Mercedes-Benz A 140 320 11 89</p>			
<p><b>Application info</b></p> <p>Mercedes-Benz BM 140 (S-Class) (02/91-12/99)</p>			

**Stabilizer link**

016 060 6319/HD

MSL0059HD

**Notes**

Carbon Neutral  
Coupling Rod  
Front Axle Right  
with spanner attachment

Length [mm] 152  
Paired article number 016 060 6318/HD | MSL0058HD  
Required quantity 1  
Thread Size 1 M12x1,5  
Thread Size 2 M10x1,5  
reinforced version  
replacement in pairs recommended

**References**

Mercedes-Benz 140 320 12 89

Mercedes-Benz A 140 320 12 89

**Application info**

Mercedes-Benz BM 140 (S-Class) (02/91-12/99)

**Stabilizer link**

036 060 0000/HD

MSL0061HD

**Notes**

Carbon Neutral  
Coupling Rod  
Front Axle Left  
with spanner attachment

Length [mm] 230  
Paired article number 036 060 0001/HD | MSL0062HD  
Required quantity 1  
Thread Size 1 M10x1,5  
Thread Size 2 M10x1,5  
reinforced version  
replacement in pairs recommended

**References**

Mercedes-Benz 638 323 04 68

Mercedes-Benz A 638 323 04 68

**Application info**

Mercedes-Benz BM 638 (V-Class / Vito) (02/96-07/03)

**Stabilizer link**

036 060 0001/HD

MSL0062HD

**Notes**

Carbon Neutral  
Coupling Rod  
Front Axle Right  
with spanner attachment

Length [mm] 230  
Paired article number 036 060 0000/HD | MSL0061HD  
Required quantity 1  
Thread Size 1 M10x1,5  
Thread Size 2 M10x1,5  
reinforced version  
replacement in pairs recommended

**References**

Mercedes-Benz 638 323 05 68

Mercedes-Benz A 638 323 05 68

**Application info**

Mercedes-Benz BM 638 (V-Class / Vito) (02/96-07/03)

**Stabilizer link**

036 060 0019

MSL0732

**Notes**

Coupling Rod  
Front Axle Left  
with spanner attachment

Length [mm] 230  
Paired article number 036 060 0020 | MSL0733  
Required quantity 1  
Thread Size 1 M10x1,5  
Thread Size 2 M10x1,5  
replacement in pairs recommended

**References**

Mercedes-Benz 638 323 04 68

Mercedes-Benz A 638 323 04 68

**Application info**

Mercedes-Benz BM 638 (V-Class / Vito) (02/96-07/03)

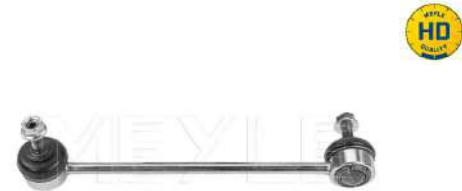
Stabilizer link		036 060 0020	MSL0733
<b>Notes</b>  Coupling Rod Front Axle Right with spanner attachment  Length [mm] 230 Paired article number 036 060 0019   MSL0732 Required quantity 1 Thread Size 1 M10x1,5 Thread Size 2 M10x1,5 replacement in pairs recommended			
<b>References</b> Mercedes-Benz 638 323 05 68		Mercedes-Benz A 638 323 05 68	
<b>Application info</b> Mercedes-Benz BM 638 (V-Class / Vito) (02/96-07/03)			
Stabilizer link		036 060 0268/HD	MSL0067HD
<b>Notes</b>  Carbon Neutral Coupling Rod Front Axle Left with spanner attachment  Length [mm] 250 Paired article number 036 060 0368/HD   MSL0069HD Required quantity 1 Thread Size 1 M10x1,5 Thread Size 2 M10x1,5 reinforced version replacement in pairs recommended			
<b>References</b> Mercedes-Benz 638 323 02 68		Mercedes-Benz A 638 323 02 68	
<b>Application info</b> Mercedes-Benz BM 638 (V-Class / Vito) (02/96-07/03)			

**Stabilizer link****036 060 0368/HD****MSL0069HD****Notes**

Carbon Neutral  
Coupling Rod  
Front Axle Right  
with spanner attachment

Length [mm] 250  
Paired article number 036 060 0268/HD | MSL0067HD  
Required quantity 1  
Thread Size 1 M10x1,5  
Thread Size 2 M10x1,5  
reinforced version  
replacement in pairs recommended

**References**

Mercedes-Benz 638 323 03 68

Mercedes-Benz A 638 323 03 68

**Application info**

Mercedes-Benz BM 638 (V-Class / Vito) (02/96-07/03)

**Stabilizer link****100 411 0007****MSL0074****Notes**

Coupling Rod  
Front Axle Left  
Front Axle Right

Inner Diameter [mm] 10  
Length [mm] 105  
Required quantity 2  
Stabiliser Diameter [mm] 23  
Thread Size 1 M10x1,5  
replacement in pairs recommended

**References**

Audi 1J0 411 315 B

Audi 1J0 411 315 G

Seat 1J0 411 315 C

Seat 1J0 411 315 J

Skoda 1J0 411 315 G

Volkswagen 1J0 411 315

Volkswagen 1J0 411 315 C

Volkswagen 1J0 411 315 G

Volkswagen (FAW) 1J0 411 315 C

Audi 1J0 411 315 C

Audi 1J0 411 315 J

Seat 1J0 411 315 G

Skoda 1J0 411 315 C

Skoda 1J0 411 315 J

Volkswagen 1J0 411 315 B

Volkswagen 1J0 411 315 E

Volkswagen 1J0 411 315 J

Volkswagen (FAW) 1J0 411 315 J

**Application info**

Audi A3 I (8L\_) (09/96-09/06)

Skoda Octavia I (1U\_) (09/96-12/10)

Volkswagen Golf IV (1J1, 1J5) (08/97-06/14)

Seat Leon I / Toledo II (1M\_) (10/98-06/06)

Volkswagen Bora (1J2, 1J6) (10/98-12/13)

Volkswagen New Beetle (1Y7, 9C1, 1C1) (01/98-12/11)

**Stabilizer link****11-16 010 0002****MSL0081****Notes**Coupling Rod  
Rear Axle Left  
Rear Axle Right

Inner Diameter [mm]

10

Length [mm]

245

Required quantity

2

Thread Size 1

M12x1,25

replacement in pairs recommended

**References**

Peugeot 16 07 325 980

Peugeot 5178.39

Peugeot 96 287 831

**Application info**

Peugeot 406 (08/95-02/05)

**Stabilizer link****11-16 060 0000/HD****MSL0082HD****Notes**Carbon Neutral  
Coupling Rod  
Front Axle Left  
Front Axle Right  
with spanner attachment

Length [mm]

335

Required quantity

2

Thread Size 1

M10x1,5

Thread Size 2

M10x1,5

reinforced version

replacement in pairs recommended



**References**

CITROËN (DF-PSA) 5087.62  
 Citroën 5087.50  
 Citroën 5087.62  
 Citroën 5087.77  
 DS 16 142 811 80  
 DS 5087 64  
 GENERAL MOTORS 93485066  
 Peugeot 16 142 811 80  
 Peugeot 5087.57  
 Peugeot 5087.64  
 Peugeot 96 347 856  
 Peugeot (DF-PSA) 5087.62

Citroën 16 142 811 80  
 Citroën 5087.57  
 Citroën 5087.64  
 Citroën 98 049 474 80  
 DS 5087 57  
 DS 98 049 474 80  
 Opel 36 37 393  
 Peugeot 5087.50  
 Peugeot 5087.62  
 Peugeot 5087.77  
 Peugeot 98 049 474 80  
 Vauxhall 36 37 393

**Application info**

Citroën Berlingo I (07/96-12/11)  
 Citroën C4 I / Coupe / Grand Picasso / Picasso / Stufenheck  
 (11/04--)  
 Citroën DS5 (09/11-07/15)  
 DS DS 5 (04/15-12/18)  
 Opel Grandland X (75) (06/17--)  
 Peugeot 307 (08/00-12/12)  
 Peugeot 5008 I (06/09-03/17)  
 Peugeot RCZ (03/10-12/15)  
 Vauxhall Grandland X (75) (06/17--)

Citroën Berlingo II (04/08--)  
 Citroën C4 II / DS4 (02/09--)  
 DS DS 4 I (07/15-12/18)  
 Opel Combo E (K9) (06/18--)  
 Peugeot 3008 I (05/09-12/17)  
 Peugeot 308 I (09/07--)  
 Peugeot Partner II (04/08--)  
 Vauxhall Combo Mk IV (06/18--)

**Stabilizer link****11-16 060 0001/HD****MSL0083HD****Notes**

Carbon Neutral  
 Coupling Rod  
 Front Axle Left  
 Front Axle Right  
 with spanner attachment

Length [mm] 335  
 Required quantity 2  
 Thread Size 1 M10x1,5  
 Thread Size 2 M10x1,5  
 reinforced version  
 replacement in pairs recommended



**References**

Citroën 16 466 219 80  
 Citroën 5087.59  
 Citroën 5087.71  
 Citroën 96 288 787  
 Citroën 98 088 682 80  
 DS 5087 59  
 DS 98 088 682 80  
 Peugeot 5087 66  
 Peugeot 5087.45  
 Peugeot 5087.71  
 Peugeot 98 000 861 80

Citroën 5087.45  
 Citroën 5087.66  
 Citroën 5087.74  
 Citroën 98 000 861 80  
 DS 16 466 219 80  
 DS 5087 71  
 Peugeot 16 46 621 980  
 Peugeot 5087 74  
 Peugeot 5087.59  
 Peugeot 96 288 787  
 Peugeot 98 088 682 80

**Application info**

Citroën C2 / C3 I / Pluriel (02/02--)  
 Citroën C3 III (07/16--)  
 Citroën DS3 (11/09-12/16)  
 Peugeot 1007 (04/05--)  
 Peugeot 206 (08/98--)

Citroën C3 II (09/09--)  
 Citroën C4 Cactus (09/14--)  
 DS DS 3 (04/15-07/19)  
 Peugeot 2008 I (03/13--)  
 Peugeot 208 I (03/12--)

**Stabilizer link****11-16 060 0002/HD****MSL0084HD****Notes**

Carbon Neutral  
 Coupling Rod  
 Front Axle Left  
 Front Axle Right  
 with spanner attachment

Length [mm] 320  
 Required quantity 2  
 Thread Size 1 M12x1,5  
 Thread Size 2 M12x1,5  
 reinforced version  
 replacement in pairs recommended

**References**

Citroën 5087.43  
 Citroën 96 324 274  
 Peugeot 5087.60



Citroën 5087.60  
 Peugeot 5087.43



**Application info**

Citroën C5 I / C5 II (03/01--)  
 Peugeot 607 (01/00--)

Peugeot 406 (08/95-02/05)



Stabilizer link		11-16 060 0009/HD	MSL0089HD
<b>Notes</b>  Carbon Neutral Coupling Rod Rear Axle Left Rear Axle Right with spanner attachment  Length [mm] 160 Required quantity 2 Thread Size 1 M10x1,5 Thread Size 2 M10x1,5 reinforced version replacement in pairs recommended			
<b>References</b> Peugeot 5178.38			
<b>Application info</b> Peugeot 406 (08/95-02/05)			
Stabilizer link		11-16 060 0013/HD	MSL0091HD
<b>Notes</b>  Carbon Neutral Coupling Rod Front Axle Left Front Axle Right with spanner attachment  Length [mm] 263 Required quantity 2 Thread Size 1 M10x1,5 Thread Size 2 M10x1,5 reinforced version replacement in pairs recommended			
<b>References</b> Citroën 5087.51 Fiat 1991209080 Peugeot 5087.51 Fiat 1331209080 Lancia 1331209080			
<b>Application info</b> Citroën C8 (06/02--) Lancia Phedra (09/02-11/10) Fiat Ulysse II (179) (08/02-06/11) Peugeot 807 (06/02--)			

Stabilizer link		11-16 060 0014	MSL0092
<b>Notes</b>  Coupling Rod Front Axle Right  Length [mm] 200 Paired article number 11-16 060 0015   MSL0093 Required quantity 1 Thread Size 1 M12x1,75 Thread Size 2 M16x1,5 replacement in pairs recommended			
<b>References</b> Citroën 16 073 261 80      Citroën 5087.53 Peugeot 16 07 326 180      Peugeot 5087.53			
<b>Application info</b> Citroën C5 III (RD_, TD_) (02/08--)      Citroën C6 (09/05-12/12) Peugeot 407 (02/04--)      Peugeot 508 I (11/10--)			
Stabilizer link		11-16 060 0015	MSL0093
<b>Notes</b>  Coupling Rod Front Axle Left  Length [mm] 200 Paired article number 11-16 060 0014   MSL0092 Required quantity 1 Thread Size 1 M12x1,75 Thread Size 2 M16x1,5 replacement in pairs recommended			
<b>References</b> Citroën 16 073 262 80      Citroën 5087.52 Peugeot 16 07 326 280      Peugeot 5087.52			
<b>Application info</b> Citroën C5 III (RD_, TD_) (02/08--)      Citroën C6 (09/05-12/12) Peugeot 407 (02/04--)      Peugeot 508 I (11/10--)			

**Stabilizer link**

11-16 060 0016/HD

MSL0094HD

**Notes**

Carbon Neutral  
Coupling Rod  
Rear Axle Left  
Rear Axle Right  
with spanner attachment

Length [mm] 141  
Required quantity 2  
Thread Size 1 M10x1,5  
Thread Size 2 M10x1,5  
reinforced version  
replacement in pairs recommended

**References**

Citroën 5178.46	Citroën 5178.52
Citroën 98 071 300 80	Peugeot 5178.46
Peugeot 5178.52	Peugeot 98 071 300 80
Toyota 48830-05020	

**Application info**

Citroën C5 III (RD_, TD_) (02/08--)	Citroën C6 (09/05-12/12)
Peugeot 407 (02/04--)	Peugeot 508 I (11/10--)
Toyota Avensis (T22) (09/97-02/03)	

**Stabilizer link**

11-16 060 0017/HD

MSL0095HD

**Notes**

Carbon Neutral  
Coupling Rod  
Front Axle Left  
with spanner attachment

Length [mm] 330  
Paired article number 11-16 060 0018/HD | MSL0096HD  
Required quantity 1  
Thread Size 1 M10x1,5  
Thread Size 2 M10x1,5  
reinforced version  
replacement in pairs recommended



**References**

Citroën 16 073 269 80

Citroën 5087.69

DS 5087 69

Peugeot 16 073 269 80

Peugeot 5087.69

Citroën 5087.54

Citroën 98 101 594 80

Opel 36 40 463

Peugeot 5087.54

Vauxhall 36 40 463

**Application info**

Citroën C Elyse (11/12--)

Citroën C3 III (07/16--)

Citroën C4 Cactus (09/14--)

DS DS 3 (04/15-07/19)

Peugeot 2008 I (03/13--)

Peugeot 208 I (03/12--)

Vauxhall Crossland X (03/17--)

Citroën C3 AIRCROSS II (06/17--)

Citroën C3 Picasso (02/09--)

Citroën DS3 (11/09-12/16)

Opel Crossland X (03/17--)

Peugeot 207 (02/06--)

Peugeot 301 (11/12--)

**Stabilizer link****11-16 060 0018/HD****MSL0096HD****Notes**

Carbon Neutral  
Coupling Rod  
Front Axle Right  
with spanner attachment

Length [mm]

330

Paired article number

11-16 060 0017/HD | MSL0095HD

Required quantity

1

Thread Size 1

M10x1,5

Thread Size 2

M10x1,5

reinforced version

replacement in pairs recommended

**References**

Citroën 16 073 268 80

Citroën 5087.68

DS 5087 68

Peugeot 16 073 268 80

Peugeot 5087.68

Citroën 5087.55

Citroën 98 101 593 80

Opel 36 40 462

Peugeot 5087.55

Vauxhall 36 40 462

**Application info**

Citroën C Elyse (11/12--)  
 Citroën C3 III (07/16--)  
 Citroën C4 Cactus (09/14--)  
 DS DS 3 (04/15-07/19)  
 Peugeot 2008 I (03/13--)  
 Peugeot 208 I (03/12--)  
 Vauxhall Crossland X (03/17--)

Citroën C3 AIRCROSS II (06/17--)  
 Citroën C3 Picasso (02/09--)  
 Citroën DS3 (11/09-12/16)  
 Opel Crossland X (03/17--)  
 Peugeot 207 (02/06--)  
 Peugeot 301 (11/12--)

**Stabilizer link****11-16 060 0020/HD****MSL0098HD****Notes**

Carbon Neutral  
 Coupling Rod  
 Front Axle Left  
 Front Axle Right  
 with spanner attachment

Length [mm] 263  
 Required quantity 2  
 Thread Size 1 M12x1,5  
 Thread Size 2 M12x1,5  
 reinforced version  
 replacement in pairs recommended

**References**

Citroën 5087.56  
 Peugeot 5087.56

Fiat 1400099680  
 Toyota SU001 A1187

**Application info**

Citroën Jumpy II (01/07--)  
 Peugeot Expert II (01/07--)

Fiat Scudo II (270) (01/07--)  
 Toyota Proace I (06/13-03/16)

**Stabilizer link****11-16 060 0021/HD****MSL0099HD****Notes**

Carbon Neutral  
Coupling Rod  
Front Axle Left  
Front Axle Right  
with spanner attachment

Length [mm]

265

Required quantity

2

Thread Size 1

M10x1,25

Thread Size 2

M10x1,25

reinforced version

replacement in pairs recommended

**References**

Citroën 5087.58

Mitsubishi MN101368

Peugeot 5087.58

Renault 546180007R

Renault 8200166160

Renault 8200669066

**Application info**

Citroën C-Crosser (02/07--)

Citroën C4 AIRCROSS (08/10--)

Mitsubishi ASX I (11/09--)

Mitsubishi Eclipse Cross (10/17--)

Mitsubishi Lancer VII (03/00-12/13)

Mitsubishi Lancer VIII (03/07--)

Mitsubishi Outlander II (11/06-12/12)

Mitsubishi Outlander III (11/10--)

Peugeot 4007 (02/07-03/13)

Peugeot 4008 (05/12--)

Renault Megane III (11/08--)

Renault Mégane II (07/01--)

Renault Scénic II (06/03-07/10)

Renault Scénic III (12/08--)

**Stabilizer link****11-16 060 0023/HD****MSL0101HD****Notes**

Carbon Neutral  
Coupling Rod  
Front Axle Left  
Front Axle Right  
with spanner attachment

Length [mm]

345

Required quantity

2

Thread Size 1

M12 X 1,75

Thread Size 2

M12 X 1,75

reinforced version

replacement in pairs recommended



**References**

Peugeot 5087.76

**Application info**

Peugeot 508 I (11/10--)

**Stabilizer link**

11-16 060 0024/HD

MSL0700HD

**Notes**

Carbon Neutral  
Coupling Rod  
Front Axle Left  
Front Axle Right  
with spanner attachment

Length [mm] 334  
Required quantity 2  
Thread Size 1 M10x1,5  
Thread Size 2 M10X1,5  
reinforced version  
replacement in pairs recommended



**References**

Citroën 98 069 071 80  
Citroën 98 328 669 80  
Citroën 98 442 647 80  
DS 98 090 457 80  
DS 98 440 614 80  
GENERAL MOTORS 9817224280  
GENERAL MOTORS 9832866980  
GENERAL MOTORS 9844264780  
Peugeot 98 069 071 80  
Peugeot 98 32 866 980  
Peugeot 98 442 647 80  
Toyota SU001-B4383

Citroën 98 090 457 80  
Citroën 98 440 614 80  
DS 98 069 071 80  
DS 98 328 669 80  
GENERAL MOTORS 9806907180  
GENERAL MOTORS 9831547080  
GENERAL MOTORS 9844061480  
Opel 98 442 647 80  
Peugeot 98 090 457 80  
Peugeot 98 440 614 80  
Toyota SU001-B1574  
Vauxhall 98 32 866 980

**Application info**

Citroën Berlingo III (06/18--)

Citroën C4 II / DS4 (02/09--)

Citroën C5 AIRCROSS (11/18--)

DS DS 7 (09/17--)

Opel Combo E (K9) (06/18--)

Peugeot 308 I (09/07--)

Peugeot 308 III (07/21--)

Peugeot 5008 II (12/16--)

Peugeot Rifter (09/18--)

Vauxhall Astra Mk VIII (10/21--)

Citroën C4 Grand Picasso II (01/13--)

Citroën C4 SPACETOURER / GRAND SPACETOURER  
(04/18--)

DS DS 4 II (10/21--)

Opel Astra L (10/21--)

Peugeot 3008 II (05/16--)

Peugeot 308 II (09/13--)

Peugeot 408 II (07/22--)

Peugeot 508 II (09/18--)

Toyota Proace City (10/19--)

**Stabilizer link****11-16 060 0025****MSL0736****Notes**Coupling Rod  
Front Axle Left  
Front Axle Right  
with spanner attachment

Length [mm]

335

Required quantity

2

Thread Size 1

M10x1,5

Thread Size 2

M10x1,5

replacement in pairs recommended

**References**

CITROËN (DF-PSA) 5087.62

Citroën 5087.62

Citroën 5087.77

DS 5087 64

GENERAL MOTORS 93485066

Peugeot 5087.50

Peugeot 5087.64

Peugeot 96 347 856

Peugeot (DF-PSA) 5087.62

Citroën 5087.50

Citroën 5087.64

Citroën 98 315 470 80

DS 98 315 470 80

Opel 36 37 393

Peugeot 5087.62

Peugeot 5087.77

Peugeot 98 31 547 080

Vauxhall 36 37 393



**Application info**

Citroën Berlingo I (07/96-12/11)

Citroën C4 Grand Picasso II (01/13--)

Citroën C4 II / DS4 (02/09--)

Citroën C5 AIRCROSS (11/18--)

DS DS 7 (09/17--)

Opel Grandland X (75) (06/17--)

Peugeot 3008 II (05/16--)

Peugeot 308 I (09/07--)

Peugeot 5008 II (12/16--)

Peugeot Rifter (09/18--)

Vauxhall Grandland X (75) (06/17--)

Citroën Berlingo III (06/18--)

Citroën C4 I / Coupe / Grand Picasso / Picasso / Stufenheck  
(11/04--)Citroën C4 SPACETOURER / GRAND SPACETOURER  
(04/18--)

DS DS 4 I (07/15-12/18)

Opel Combo E (K9) (06/18--)

Peugeot 3008 I (05/09-12/17)

Peugeot 307 (08/00-12/12)

Peugeot 308 II (09/13--)

Peugeot 508 II (09/18--)

Vauxhall Combo Mk IV (06/18--)

**Stabilizer link****11-16 060 0026****MSL0737****Notes**Coupling Rod  
Front Axle Left  
Front Axle Right  
with spanner attachment

Length [mm]

335

Required quantity

2

Thread Size 1

M10x1,5

Thread Size 2

M10x1,5

replacement in pairs recommended

**References**

Citroën 16 073 234 80

Citroën 5087.45

Citroën 5087.66

Citroën 5087.74

Citroën 98 000 861 80

DS 16 466 219 80

DS 5087 71

Peugeot 16 07 323 480

Peugeot 5087 66

Peugeot 5087.45

Peugeot 5087.71

Peugeot 98 000 861 80

Citroën 16 466 219 80

Citroën 5087.59

Citroën 5087.71

Citroën 96 288 787

Citroën 98 088 682 80

DS 5087 59

DS 98 088 682 80

Peugeot 16 46 621 980

Peugeot 5087 74

Peugeot 5087.59

Peugeot 96 288 787

Peugeot 98 088 682 80

**Application info**

Citroën C2 / C3 I / Pluriel (02/02--)

Citroën C3 III (07/16--)

Citroën DS3 (11/09-12/16)

Peugeot 1007 (04/05--)

Peugeot 206 (08/98--)

Citroën C3 II (09/09--)

Citroën C4 Cactus (09/14--)

DS DS 3 (04/15-07/19)

Peugeot 2008 I (03/13--)

Peugeot 208 I (03/12--)

**Stabilizer link**

11-16 060 0028

MSL0738

**Notes**

Coupling Rod  
 Front Axle Left  
 Front Axle Right  
 with spanner attachment

Length [mm]

335

Required quantity

2

Thread Size 1

M10x1,5

Thread Size 2

M10x1,5

replacement in pairs recommended

**References**

Citroën 5087.57

DS 5087 57

Peugeot 5087.57

Toyota SU001B4383

Citroën 98 049 474 80

DS 98 049 474 80

Peugeot 98 049 474 80

**Application info**

Citroën Berlingo II (04/08--)

Citroën DS5 (09/11-07/15)

Peugeot 3008 I (05/09-12/17)

Peugeot Partner II (04/08--)

Citroën C4 I / Coupe / Grand Picasso / Picasso / Stufenheck  
(11/04--)

DS DS 5 (04/15-12/18)

Peugeot 5008 I (06/09-03/17)

Peugeot RCZ (03/10-12/15)

**Stabilizer link**

11-16 060 0030

MSL0740

**Notes**

Coupling Rod  
 Front Axle Left  
 Front Axle Right  
 with spanner attachment

Length [mm]

320

Required quantity

2

Thread Size 1

M12x1,5

Thread Size 2

M10x1,5

replacement in pairs recommended



**References**

Citroën 5087.43  
 Citroën 96 324 274  
 Peugeot 5087.60

Citroën 5087.60  
 Peugeot 5087.43

**Application info**

Citroën C5 I / C5 II (03/01--)  
 Peugeot 406 (08/95-02/05)

Citroën Xantia (03/93-04/03)  
 Peugeot 607 (01/00--)

**Stabilizer link****11-16 060 0031****MSL0741****Notes**

Coupling Rod  
 Rear Axle Left  
 Rear Axle Right  
 with spanner attachment

Length [mm] 160  
 Required quantity 2  
 Thread Size 1 M10x1,5  
 Thread Size 2 M10x1,5  
 replacement in pairs recommended

**References**

Peugeot 5178.38

**Application info**

Peugeot 406 (08/95-02/05)

**Stabilizer link****11-16 060 0032****MSL0742****Notes**

Coupling Rod  
 Front Axle Left  
 Front Axle Right  
 with spanner attachment

Length [mm] 263  
 Required quantity 2  
 Thread Size 1 M10x1,5  
 Thread Size 2 M10x1,5  
 replacement in pairs recommended



**References**

Citroën 16 073 253 80  
 Fiat 1331209080  
 Lancia 1331209080  
 Peugeot 5087.51

Citroën 5087.51  
 Fiat 1991209080  
 Peugeot 16 07 325 380

**Application info**

Citroën C8 (06/02--)  
 Lancia Phedra (09/02-11/10)

Fiat Ulysse II (179) (08/02-06/11)  
 Peugeot 807 (06/02--)

**Stabilizer link**

11-16 060 0033

MSL0743

**Notes**

Coupling Rod  
 Rear Axle Left  
 Rear Axle Right  
 with spanner attachment

Length [mm] 141  
 Required quantity 2  
 Thread Size 1 M10x1,5  
 Thread Size 2 M10x1,5  
 replacement in pairs recommended



**References**

Citroën 16 073 260 80  
 Citroën 5178.52  
 Peugeot 16 073 260 80  
 Peugeot 5178.52

Citroën 5178.46  
 Citroën 98 071 300 80  
 Peugeot 5178.46  
 Peugeot 98 071 300 80

**Application info**

Citroën C5 III (RD\_, TD\_) (02/08--)  
 Peugeot 407 (02/04--)

Citroën C6 (09/05-12/12)  
 Peugeot 508 I (11/10--)

**Stabilizer link**

11-16 060 0034

MSL0744

**Notes**

Coupling Rod  
 Front Axle Right  
 with spanner attachment

Length [mm] 330  
 Paired article number 11-16 060 0035 | MSL0745  
 Required quantity 1  
 Thread Size 1 M10x1,5  
 Thread Size 2 M10x1,5  
 replacement in pairs recommended



**References**

Citroën 16 073 268 80  
 Citroën 5087.68  
 DS 5087 68  
 Peugeot 16 073 268 80  
 Peugeot 5087.68

Citroën 5087.55  
 Citroën 98 101 593 80  
 Opel 36 40 462  
 Peugeot 5087.55  
 Vauxhall 36 40 462

**Application info**

Citroën C Elyse (11/12--)  
 Citroën C3 III (07/16--)  
 Citroën C4 Cactus (09/14--)  
 DS DS 3 (04/15-07/19)  
 Peugeot 2008 I (03/13--)  
 Peugeot 208 I (03/12--)  
 Vauxhall Crossland X (03/17--)

Citroën C3 AIRCROSS II (06/17--)  
 Citroën C3 Picasso (02/09--)  
 Citroën DS3 (11/09-12/16)  
 Opel Crossland X (03/17--)  
 Peugeot 207 (02/06--)  
 Peugeot 301 (11/12--)

**Stabilizer link****11-16 060 0035****MSL0745****Notes**

Coupling Rod  
 Front Axle Left  
 with spanner attachment  
 Length [mm] 330  
 Paired article number 11-16 060 0034 | MSL0744  
 Required quantity 1  
 Thread Size 1 M10x1,5  
 Thread Size 2 M10x1,5

replacement in pairs recommended

**References**



Citroën 16 073 269 80  
 Citroën 5087.69  
 DS 5087 69  
 Peugeot 16 073 269 80  
 Peugeot 5087.69

Citroën 5087.54  
 Citroën 98 101 594 80  
 Opel 36 40 463  
 Peugeot 5087.54  
 Vauxhall 36 40 463

**Application info**

Citroën C Elyse (11/12--)  
 Citroën C3 III (07/16--)  
 Citroën C4 Cactus (09/14--)  
 DS DS 3 (04/15-07/19)  
 Peugeot 2008 I (03/13--)  
 Peugeot 208 I (03/12--)  
 Vauxhall Crossland X (03/17--)

Citroën C3 AIRCROSS II (06/17--)  
 Citroën C3 Picasso (02/09--)  
 Citroën DS3 (11/09-12/16)  
 Opel Crossland X (03/17--)  
 Peugeot 207 (02/06--)  
 Peugeot 301 (11/12--)

Stabilizer link		11-16 060 0036	MSL0746
<b>Notes</b>  Coupling Rod Front Axle Left Front Axle Right with spanner attachment  Length [mm] 263 Required quantity 2 Thread Size 1 M12x1,5 Thread Size 2 M12x1,5 replacement in pairs recommended			
<b>References</b> Citroën 16 109 305 80 Citroën 5087.56 Fiat 1400099680 Peugeot 5087.56 Toyota SU001 A1187			
<b>Application info</b> Citroën Jumpy II (01/07--) Peugeot Expert II (01/07--) Fiat Scudo II (270) (01/07--) Toyota Proace I (06/13-03/16)			
Stabilizer link		11-16 060 0037	MSL0747
<b>Notes</b>  Coupling Rod Front Axle Left Front Axle Right with spanner attachment  Length [mm] 265 Required quantity 2 Thread Size 1 M10x1,25 Thread Size 2 M10x1,25 replacement in pairs recommended			
<b>References</b> Citroën 5087.58 Mitsubishi MN101368 Peugeot 5087.58 Renault 546180007R Renault 8200166160 Renault 8200669066			

**Application info**

Citroën C-Crosser (02/07--)

Mitsubishi ASX I (11/09--)

Mitsubishi Lancer VII (03/00-12/13)

Mitsubishi Outlander II (11/06-12/12)

Peugeot 4007 (02/07-03/13)

Renault Megane III (11/08--)

Renault Scénic II (06/03-07/10)

Citroën C4 AIRCROSS (08/10--)

Mitsubishi Eclipse Cross (10/17--)

Mitsubishi Lancer VIII (03/07--)

Mitsubishi Outlander III (11/10--)

Peugeot 4008 (05/12--)

Renault Mégane II (07/01--)

Renault Scénic III (12/08--)

**Stabilizer link****11-16 060 0040****MSL0750****Notes**

Coupling Rod  
 Front Axle Left  
 Front Axle Right  
 with spanner attachment

Length [mm]

300

Required quantity

2

Thread Size 1

M10x1,5

Thread Size 2

M10x1,5

replacement in pairs recommended

**References**

CITROËN (DF-PSA) 5087.61

Citroën 5087.39

Citroën 5087.46

Peugeot 16 07 322 580

Peugeot 5087.39

Peugeot 5087.46

Citroën 16 073 225 80

Citroën 5087.42

Citroën 5087.61

Peugeot 16 07 322 980

Peugeot 5087.42

Peugeot 5087.61

**Application info**

Citroën Berlingo I (07/96-12/11)

Citroën Xsara Picasso (09/99-06/12)

Peugeot 306 (01/93-10/03)

Peugeot Partner II (04/08--)

Citroën Xsara (04/97-03/10)

Citroën ZX (03/91-07/99)

Peugeot Partner I (05/96--)

**Stabilizer link****11-16 060 0041/HD****MSL1020HD****Notes**

Carbon Neutral  
Coupling Rod  
Front Axle Left  
Front Axle Right

Length [mm]

355

Required quantity

2

Thread Size 1

M12X1,5

Thread Size 2

M12X1,5

reinforced version

replacement in pairs recommended

**References**

Citroën 98 090 901 80

GENERAL MOTORS 9809090180

Toyota SU001-A6492

Fiat 9809090180

Peugeot 98 09 090 180

**Application info**

Citroën Jumpy III (04/16--)

Opel Vivaro C (03/19--)

Peugeot Traveller (04/16--)

Vauxhall Vivaro C (03/19--)

Citroën Spacetourer (04/16--)

Peugeot Expert III (04/16--)

Toyota Proace II (02/16--)

**Stabilizer link****11-16 060 0045/HD****MSL1083HD****Notes**

Carbon Neutral  
Coupling Rod  
Front Axle Left  
Front Axle Right

Length [mm]

324

Required quantity

2

Thread Size 1

M10x1,5

Thread Size 2

M10x1,5

reinforced version

replacement in pairs recommended

**References**

Citroën 98 246 525 80

GENERAL MOTORS 98 246 525 80

Peugeot 98 24 652 580

DS 98 246 525 80

Opel 98 246 525 80

Vauxhall 98 246 525 80



**Application info**

Citroën C4 III (10/20--)  
 DS DS 3 CROSSBACK (10/18--)  
 Opel Mokka B (06/20--)  
 Peugeot 208 II (06/19--)  
 Vauxhall Mokka B (06/20--)

Citroën C4 X (09/22--)  
 Opel Corsa F (07/19--)  
 Peugeot 2008 II (08/19--)  
 Vauxhall Corsa Mk V (F) (07/19--)

**Stabilizer link****11-16 060 0046/HD****MSL1011HD****Notes**

Carbon Neutral  
 Coupling Rod  
 Rear Axle Left  
 Rear Axle Right

Length [mm] 170  
 Required quantity 2  
 Thread Size 1 M10X1,5  
 Thread Size 2 M10X1,5  
 reinforced version  
 replacement in pairs recommended

**References**

DS 98 152 270 80

Peugeot 98 15 227 080

**Application info**

DS DS 7 (09/17--)

Peugeot 508 II (09/18--)

**Stabilizer link****11-16 060 0047/HD****MSL1129HD****Notes**

Carbon Neutral  
 Coupling Rod  
 Front Axle Left

Length [mm] 240  
 Paired article number 11-16 060 0048/HD | MSL1130HD  
 Required quantity 1  
 Thread Size 1 10x1,5  
 Thread Size 2 10x1,5  
 reinforced version  
 replacement in pairs recommended

**References**

Citroën 5087.80

Mitsubishi 4056A065

Peugeot 5087.80

**Application info**

Citroën C-Zero (10/10--)  
Peugeot Ion (11/10--)

Mitsubishi i (01/06--)

**Stabilizer link****11-16 060 0048/HD****MSL1130HD****Notes**

Carbon Neutral  
Coupling Rod  
Front Axle Right

Length [mm] 240  
Paired article number 11-16 060 0047/HD | MSL1129HD  
Required quantity 1  
Thread Size 1 10x1,5  
Thread Size 2 10x1,5  
replacement in pairs recommended

**References**

Citroën 5087.81  
Peugeot 5087.81

Mitsubishi 4056A066

**Application info**

Citroën C-Zero (10/10--)  
Peugeot Ion (11/10--)

Mitsubishi i (01/06--)

**Stabilizer link****11-16 060 5041/HD****MSL0102HD****Notes**

Carbon Neutral  
Coupling Rod  
Front Axle Left  
Front Axle Right  
with spanner attachment

Length [mm] 322  
Required quantity 2  
Thread Size 1 M12x1,5  
Thread Size 2 M12x1,5  
reinforced version  
replacement in pairs recommended

**References**

Citroën 16 073 230 80  
Citroën 96 177 836  
Peugeot 5087.40

Citroën 5087.40  
Peugeot 16 07 323 080

**Application info**

Citroën Saxo (02/96-04/04)  
Peugeot 106 (08/91-05/05)

Citroën Xantia (03/93-04/03)  
Peugeot 406 (08/95-02/05)

**Stabilizer link****11-16 060 5046/HD****MSL0103HD****Notes**

Carbon Neutral  
Coupling Rod  
Front Axle Left  
Front Axle Right  
with spanner attachment

Length [mm] 300  
Required quantity 2  
Thread Size 1 M10x1,5  
Thread Size 2 M10x1,5  
reinforced version  
replacement in pairs recommended

**References**



CITROËN (DF-PSA) 5087.61  
Citroën 5084.38  
Citroën 5087.38  
Citroën 5087.42  
Citroën 5087.48  
Citroën 96 152 213  
Peugeot 5015.48  
Peugeot 5087.34  
Peugeot 5087.39  
Peugeot 5087.46  
Peugeot 5087.61



Citroën 16 073 247 80  
Citroën 5087.34  
Citroën 5087.39  
Citroën 5087.46  
Citroën 5087.61  
Peugeot 16 07 324 780  
Peugeot 5087.31  
Peugeot 5087.38  
Peugeot 5087.42  
Peugeot 5087.48  
Peugeot (DF-PSA) 5087.61

**Application info**

Citroën Berlingo I (07/96-12/11)  
Citroën Xantia (03/93-04/03)  
Citroën Xsara Picasso (09/99-06/12)  
Peugeot 306 (01/93-10/03)  
Peugeot Partner I (05/96--)

Citroën C5 I / C5 II (03/01--)  
Citroën Xsara (04/97-03/10)  
Citroën ZX (03/91-07/99)  
Peugeot 607 (01/00--)  
Peugeot Partner II (04/08--)

Stabilizer link		11-16 060 5707	MSL0104
<b>Notes</b>  Coupling Rod Front Axle Left Front Axle Right  Length [mm] 360 Required quantity 2 Thread Size 1 M10x1,5 Thread Size 2 M10x1,5 replacement in pairs recommended			
<b>References</b> Citroën 96 103 814 Peugeot 5087.23 Peugeot 5087.32			
<b>Application info</b> Citroën C15 / Visa (09/78-10/06) Peugeot 205 (02/83-12/00) Peugeot 309 (10/85-12/93)			
Stabilizer link		116 031 0025	MSL0105
<b>Notes</b>  Coupling Rod Rear Axle Left  Paired article number 116 031 0026   MSL0106 Required quantity 1 replacement in pairs recommended			
<b>References</b> Audi 4E0 505 547 A Audi 4E0 505 547 L			
<b>Application info</b> Audi A8 II (4E_) (10/02-12/10)			

Stabilizer link		116 031 0026	MSL0106
<b>Notes</b>  Paired article number Required quantity replacement in pairs recommended	Coupling Rod Rear Axle Right 116 031 0025   MSL0105 1		
<b>References</b> Audi 4E0 505 548 A Audi 4E0 505 548 L			
<b>Application info</b> Audi A8 II (4E_) (10/02-12/10)			
Strut mount		100 412 0400	MSM0281
<b>Notes</b>  Required quantity replacement in pairs recommended	Front Axle Piece Rubber-Metal Mount without bearing 2		
<b>References</b> MAN 65.43431-0002 Volkswagen 2N0 412 331 C			
<b>Application info</b> MAN TGE (11/16--) Volkswagen Crafter II (SY_) (09/16--)			

**Strut mount**

100 741 0007

MSM0280

**Notes**

Rear Axle  
without bearing

Housing Diameter [mm] 56  
Required quantity 2  
replacement in pairs recommended



**References**

Audi 5Q0 513 353 H  
Volkswagen 5Q0 513 353 H

Seat 5Q0 513 353 H  
Volkswagen (FAW) 5Q0 513 353 H

**Application info**

Audi A3 III (8V\_) (04/12--)  
Volkswagen Golf VII (5G1,BA5) (08/12--)

Seat Leon III (5F\_) (09/12--)

**Suspension Kit**

014 610 0061

MCR0053

**Notes**

Front Axle Left  
Front Axle Right

Required quantity 2  
replacement in pairs recommended



**References**

Mercedes-Benz 246 330 17 07  
Mercedes-Benz 246 330 47 00  
Mercedes-Benz 246 333 00 14  
Mercedes-Benz 246 333 02 00  
Mercedes-Benz 246 333 05 14  
Mercedes-Benz A 246 330 17 07  
Mercedes-Benz A 246 330 47 00  
Mercedes-Benz A 246 333 00 14  
Mercedes-Benz A 246 333 02 00  
Mercedes-Benz A 246 333 05 14

Mercedes-Benz 246 330 18 07  
Mercedes-Benz 246 330 48 00  
Mercedes-Benz 246 333 01 00  
Mercedes-Benz 246 333 02 14  
Mercedes-Benz 246 333 06 14  
Mercedes-Benz A 246 330 18 07  
Mercedes-Benz A 246 330 48 00  
Mercedes-Benz A 246 333 01 00  
Mercedes-Benz A 246 333 02 14  
Mercedes-Benz A 246 333 06 14

**Application info**

Mercedes-Benz BM 117 (CLA) (01/13-03/19)  
 Mercedes-Benz BM 176 (A-Class) (06/12-05/18)

Mercedes-Benz BM 156 (GLA-Class) (12/13--)  
 Mercedes-Benz BM 246 (B-Class) (10/11-12/18)

**Suspension Kit**

014 610 0062

MCR0054

**Notes**

Required quantity  
 replacement in pairs recommended

Front Axle Left  
 Front Axle Right  
 2



**References**

Mercedes-Benz 203 333 02 14  
 Mercedes-Benz 204 330 31 11  
 Mercedes-Benz 204 330 67 11  
 Mercedes-Benz 204 333 10 14  
 Mercedes-Benz A 203 333 02 14  
 Mercedes-Benz A 204 330 31 11  
 Mercedes-Benz A 204 330 67 11  
 Mercedes-Benz A 204 333 10 14  
 Mercedes-Benz (BBDC) 203 333 10 14  
 Mercedes-Benz (BBDC) 204 330 68 11  
 Mercedes-Benz (BBDC) A 204 330 67 11

Mercedes-Benz 203 333 10 14  
 Mercedes-Benz 204 330 32 11  
 Mercedes-Benz 204 330 68 11  
 Mercedes-Benz 211 333 29 14  
 Mercedes-Benz A 203 333 10 14  
 Mercedes-Benz A 204 330 32 11  
 Mercedes-Benz A 204 330 68 11  
 Mercedes-Benz A 211 333 29 14  
 Mercedes-Benz (BBDC) 204 330 67 11  
 Mercedes-Benz (BBDC) A 203 333 10 14  
 Mercedes-Benz (BBDC) A 204 330 68 11

**Application info**

Mercedes-Benz BM 172 (SLC) (01/16--)  
 Mercedes-Benz BM 204 (C-Class) (01/07--)

Mercedes-Benz BM 172 (SLK) (01/11--)  
 Mercedes-Benz BM 207 (E-Class) (01/09-12/16)

**Suspension Kit**

014 610 0063

MCR0055

**Notes**

Required quantity  
 replacement in pairs recommended

Front Axle Left  
 Front Axle Right  
 2



**References**

- |                                      |                                      |
|--------------------------------------|--------------------------------------|
| Mercedes-Benz 212 330 29 11          | Mercedes-Benz 212 330 30 11          |
| Mercedes-Benz 212 333 00 14          | Mercedes-Benz 212 333 03 14          |
| Mercedes-Benz A 212 330 29 11        | Mercedes-Benz A 212 330 30 11        |
| Mercedes-Benz A 212 333 00 14        | Mercedes-Benz A 212 333 03 14        |
| Mercedes-Benz (BBDC) 212 333 00 14   | Mercedes-Benz (BBDC) 212 333 03 14   |
| Mercedes-Benz (BBDC) A 212 333 00 14 | Mercedes-Benz (BBDC) A 212 333 03 14 |

**Application info**

Mercedes-Benz BM 212 (E-Class) (01/09-12/16)

**Suspension Kit**

014 610 0064

MCR0042

**Notes**

Front Axle Left  
 Front Axle Right  
 Required quantity 2  
 replacement in pairs recommended





**References**

- |                                      |                                      |
|--------------------------------------|--------------------------------------|
| Mercedes-Benz 211 330 81 07          | Mercedes-Benz 211 330 82 07          |
| Mercedes-Benz 211 330 91 07          | Mercedes-Benz 211 330 92 07          |
| Mercedes-Benz 211 333 10 14          | Mercedes-Benz 211 333 11 14          |
| Mercedes-Benz 211 333 19 14          | Mercedes-Benz 211 333 25 14          |
| Mercedes-Benz 211 333 28 14          | Mercedes-Benz 211 333 29 14          |
| Mercedes-Benz A 211 330 81 07        | Mercedes-Benz A 211 330 82 07        |
| Mercedes-Benz A 211 330 91 07        | Mercedes-Benz A 211 330 92 07        |
| Mercedes-Benz A 211 333 10 14        | Mercedes-Benz A 211 333 11 14        |
| Mercedes-Benz A 211 333 19 14        | Mercedes-Benz A 211 333 25 14        |
| Mercedes-Benz A 211 333 28 14        | Mercedes-Benz A 211 333 29 14        |
| Mercedes-Benz (BBDC) 211 330 91 07   | Mercedes-Benz (BBDC) 211 330 92 07   |
| Mercedes-Benz (BBDC) 211 333 11 14   | Mercedes-Benz (BBDC) 211 333 29 14   |
| Mercedes-Benz (BBDC) A 211 330 91 07 | Mercedes-Benz (BBDC) A 211 330 92 07 |
| Mercedes-Benz (BBDC) A 211 333 11 14 | Mercedes-Benz (BBDC) A 211 333 29 14 |

**Application info**

Mercedes-Benz BM 211 (E-Class) (03/02-07/09) Mercedes-Benz BM 219 (CLS) (10/04-02/11)



Suspension Kit		016 610 0002	MCR0088
<p><b>Notes</b></p> <p>Front Axle Left Front Axle Right for control arm with ball joint with rubber mount</p> <p>Required quantity replacement in pairs recommended</p> <p>2</p>			
<p><b>References</b></p> <p>Smart 450 333 00 14 Smart A 450 333 00 14</p>		<p>Smart 451 330 00 10 Smart A 451 330 00 10</p>	
<p><b>Application info</b></p> <p>Smart Fortwo II (01/07--)</p>			
Suspension Kit		016 610 0005	MCR0061
<p><b>Notes</b></p> <p>Front Axle Left for control arm with ball joint with rubber mount</p> <p>Paired article number Required quantity replacement in pairs recommended</p> <p>016 610 0006   MCR0062 1</p>			
<p><b>References</b></p> <p>Mercedes-Benz 639 330 12 07 Mercedes-Benz A 639 330 12 07</p>		<p>Mercedes-Benz 639 330 14 01 Mercedes-Benz A 639 330 14 01</p>	
<p><b>Application info</b></p> <p>Mercedes-Benz BM 639 (Vito / Viano) (08/03--)</p>			

**Suspension Kit** **016 610 0006** **MCR0062**

**Notes**

Front Axle Right  
for control arm  
with ball joint  
with rubber mount

Paired article number 016 610 0005 | MCR0061  
Required quantity 1  
replacement in pairs recommended



**References**

Mercedes-Benz 639 330 13 07 Mercedes-Benz 639 330 15 01  
Mercedes-Benz A 639 330 13 07 Mercedes-Benz A 639 330 15 01

**Application info**

Mercedes-Benz BM 639 (Vito / Viano) (08/03--)

**Suspension Kit** **016 610 0007** **MCR0063**

**Notes**

Front Axle Left  
Front Axle Right  
for control arm  
with ball joint  
with rubber mount

Required quantity 2  
replacement in pairs recommended



**References**

Mercedes-Benz 901 330 16 07 Mercedes-Benz 901 330 17 07  
Mercedes-Benz 901 330 18 07 Mercedes-Benz 901 330 19 07  
Mercedes-Benz 901 330 24 07 Mercedes-Benz 901 330 25 07  
Mercedes-Benz A 901 330 16 07 Mercedes-Benz A 901 330 17 07  
Mercedes-Benz A 901 330 18 07 Mercedes-Benz A 901 330 19 07  
Mercedes-Benz A 901 330 24 07 Mercedes-Benz A 901 330 25 07  
Volkswagen 2D0 407 021 Volkswagen 2D0 407 021 A  
Volkswagen 2D0 407 021 B Volkswagen 2D0 407 021 C  
Volkswagen 2D0 407 022 Volkswagen 2D0 407 022 A  
Volkswagen 2D0 407 022 B Volkswagen 2D0 407 022 C

**Application info**

Mercedes-Benz BM 901 / 902 (Sprinter I) (01/95-05/06)  
 Mercedes-Benz BM 904 (Sprinter I) (02/95-05/12)  
 Volkswagen LT II (04/96-07/06)

Mercedes-Benz BM 903 (Sprinter I) (01/95-05/12)  
 Mercedes-Benz BM 909 (Sprinter) (09/13--)

**Suspension Kit**

100 610 0037/HD

MCR0017HD

**Notes**

Carbon Neutral  
 Front Axle Left  
 Front Axle Right  
 Rear  
 with accessories

Replace in pairs only  
 Required quantity  
 reinforced version

2



**References**

Audi 3C0 199 231 D  
 Audi 3C0 199 231 F  
 Seat 3C0 199 231 E  
 Volkswagen 3C0 199 231 A  
 Volkswagen 3C0 199 231 D  
 Volkswagen 3C0 199 231 F

Audi 3C0 199 231 E  
 Seat 3C0 199 231 D  
 Seat 3C0 199 231 F  
 Volkswagen 3C0 199 231 B  
 Volkswagen 3C0 199 231 E  
 Volkswagen (FAW) 3C0 199 231 D

**Application info**

Audi Q3 I (8U\_) (06/11-12/18)  
 Volkswagen CC (11/11-12/16)  
 Volkswagen Passat (3C\_) (03/05-01/12)  
 Volkswagen Tiguan I (5N) (09/07-07/18)

Seat Alhambra II (710) (06/10--)  
 Volkswagen Passat (362, 365) (08/10-12/15)  
 Volkswagen Sharan (7N) (05/10--)

**Suspension Kit**

100 610 0045

MCR0033

**Notes**

Front Axle Left  
 with accessories  
 with rubber mount

Paired article number  
 Required quantity  
 replacement in pairs recommended

100 610 0046 | MCR0034  
 1



**References**

- |                              |                          |
|------------------------------|--------------------------|
| Audi 1K0 199 231 G           | Audi 1K0 199 231 J       |
| Audi 1K0 199 231 K           | Seat 1K0 199 231 J       |
| Seat 1K0 199 231 K           | Skoda 1K0 199 231 J      |
| Skoda (SVW) 1K0 199 231 J    | Volkswagen 1K0 199 231 G |
| Volkswagen 1K0 199 231 J     | Volkswagen 1K0 199 231 K |
| Volkswagen (FAW) 1K0 199 231 |                          |

**Application info**

- |   |  |
|---|--|
| Audi A3 II (8P_) (05/03-12/15)                  | Seat Leon II / Toledo III / Altea (1P_ ,5P_) (03/04--) |
| Skoda Octavia II (1Z_) (02/04-06/13)            | Skoda Superb II (3T) (03/08-05/15)                     |
| Skoda Yeti (5L) (05/09-12/17)                   | Volkswagen Beetle (5C1) (04/11-07/19)                  |
| Volkswagen Caddy III (2KA, 2KB) (03/04-05/15)   | Volkswagen Eos (03/06-08/15)                           |
| Volkswagen Golf V (1K1, 1K5, 5M1) (10/03-08/14) | Volkswagen Golf VI (5K1, 517, AJ5) (10/08-05/16)       |
| Volkswagen Jetta III (1K2) (09/04-12/13)        | Volkswagen Scirocco III (137) (05/08-11/17)            |
| Volkswagen Touran I ( 1T1/2/3) (02/03-05/15)    |  |

**Suspension Kit**

100 610 0046

MCR0034

**Notes**

Front Axle Right  
with accessories  
with rubber mount

Paired article number 100 610 0045 | MCR0033

Required quantity 1

replacement in pairs recommended



**References**

- |                           |                                |
|---------------------------|--------------------------------|
| Audi 1K0 199 232 G        | Audi 1K0 199 232 J             |
| Seat 1K0 199 232 J        | Skoda 1K0 199 232 J            |
| Skoda (SVW) 1K0 199 232 J | Volkswagen 1K0 199 232 G       |
| Volkswagen 1K0 199 232 J  | Volkswagen (FAW) 1K0 199 232 J |

**Application info**

- |   |  |
|---|--|
| Audi A3 II (8P_) (05/03-12/15)                  | Seat Leon II / Toledo III / Altea (1P_ ,5P_) (03/04--) |
| Skoda Octavia II (1Z_) (02/04-06/13)            | Skoda Superb II (3T) (03/08-05/15)                     |
| Skoda Yeti (5L) (05/09-12/17)                   | Volkswagen Beetle (5C1) (04/11-07/19)                  |
| Volkswagen Caddy III (2KA, 2KB) (03/04-05/15)   | Volkswagen Eos (03/06-08/15)                           |
| Volkswagen Golf V (1K1, 1K5, 5M1) (10/03-08/14) | Volkswagen Golf VI (5K1, 517, AJ5) (10/08-05/16)       |
| Volkswagen Jetta III (1K2) (09/04-12/13)        | Volkswagen Scirocco III (137) (05/08-11/17)            |
| Volkswagen Touran I ( 1T1/2/3) (02/03-05/15)    |  |

## Suspension Kit

100 610 0059/HD

MCR0041HD

## Notes

Carbon Neutral  
Front Axle Left  
Front Axle Right

Replace in pairs only

Required quantity  
reinforced version

2



## References

Audi 4E0 407 181 B

Audi 4E0 407 183 B

Audi 4E0 407 515 D

Audi 4G0 407 183 A

Audi 4H0 407 183 C

Audi 4H0 407 515 A

Audi 8D0 407 515 A

Audi 8D0 407 515 C

Audi 8K0 407 182 B

Audi 8K0 407 515

Audi (FAW) 4E0 407 181 B

Audi (FAW) 4GD 407 181

Audi (FAW) 8D0 407 515 B

Audi (FAW) 8K0 407 182 B

Audi (FAW) L8K0 407 182 B

Audi 4E0 407 183 A

Audi 4E0 407 183 H

Audi 4G0 407 183

Audi 4H0 407 183 B

Audi 4H0 407 515

Audi 4H0 407 515 B

Audi 8D0 407 515 B

Audi 8K0 407 182 A

Audi 8K0 407 182 C

Audi 8R0 407 515

Audi (FAW) 4G0 407 183 B

Audi (FAW) 4GD 407 515

Audi (FAW) 8D0 407 515 C

Audi (FAW) 8K0 407 182 C

## Application info

Audi A4 IV (8K\_) (08/07-05/16)

Audi A6 IV (4G2, 4G5, C7) (11/10-09/18)

Audi Q5 I (8R\_) (11/08-12/17)

Audi A5 I (8F\_ , 8T\_) (06/07-01/17)

Audi A7 I Sportback (4G\_) (07/10-05/18)

## Suspension Kit

100 610 0061

MCR0043

## Notes

Front Axle Left  
Front Axle Right

Required quantity 2  
replacement in pairs recommended



## References

Audi 1J0 407 181	Audi 1J0 407 181 A
Audi 357 407 182	Seat 1J0 407 181
Seat 1J0 407 181 A	Seat 357 407 182
Skoda 1J0 407 181	Skoda 1J0 407 181 A
Skoda 357 407 182	Skoda (SVW) 180 407 182
Volkswagen 1J0 407 181	Volkswagen 1J0 407 181 A
Volkswagen 357 407 182	Volkswagen (FAW) L357 407 182
Volkswagen (SVW) 180 407 182	

## Application info

Audi A1 I (8X_) (05/10-10/18)	Audi A3 I (8L_) (09/96-09/06)
Audi TT I (8N_) (10/98-12/06)	Seat Ibiza IV (6J_ ,6P_) (03/08-12/18)
Seat Leon I / Toledo II (1M_) (10/98-06/06)	Seat Mii (10/11--)
Seat Toledo IV (KG3) (07/12-04/19)	Skoda Citigo (10/11--)
Skoda Fabia II (54_) (12/06-12/14)	Skoda Fabia III (NJ_) (08/14--)
Skoda Octavia I (1U_) (09/96-12/10)	Skoda Rapid II (N_) (07/12-12/19)
Skoda Roomster (03/06-05/15)	Volkswagen Bora (1J2, 1J6) (10/98-12/13)
Volkswagen Golf IV (1J1, 1J5) (08/97-06/14)	Volkswagen New Beetle (1Y7, 9C1, 1C1) (01/98-12/11)
Volkswagen Passat (3B_) (08/96-12/05)	Volkswagen Polo (6R_) (03/09--)
Volkswagen Polo (9N_) (10/01--)	Volkswagen UP (08/11--)

**Suspension Kit**

100 610 0062/HD

MCR0051HD

**Notes**

Carbon Neutral  
Front Axle Left  
Front Axle Right

Replace in pairs only

Required quantity

2



**References**

Audi 1K0 199 232 G  
Audi 1K0 407 182  
Audi 5Q0 407 182  
Seat 1K0 199 232 J  
Seat 1K0 407 182 A  
Seat 5Q0 407 182 A  
Skoda 1K0 407 182  
Skoda 1K0 407 182 F  
Skoda (SVW) 1K0 199 231 J  
Skoda (SVW) 1K0 407 182  
Volkswagen 1K0 199 232 J  
Volkswagen 1K0 407 182 A  
Volkswagen 5Q0 407 182  
Volkswagen (FAW) 1KD 407 182

Audi 1K0 199 232 J  
Audi 1K0 407 182 F  
Audi 5Q0 407 182 A  
Seat 1K0 407 182  
Seat 1K0 407 182 F  
Skoda 1K0 199 232 J  
Skoda 1K0 407 182 A  
Skoda 5Q0 407 182  
Skoda (SVW) 1K0 199 232 J  
Volkswagen 1K0 199 232 G  
Volkswagen 1K0 407 182  
Volkswagen 1K0 407 182 F  
Volkswagen (FAW) 1K0 199 231  
Volkswagen (FAW) 5Q0 407 182

**Application info**

Audi A3 II (8P\_) (05/03-12/15)  
Skoda Octavia II (1Z\_) (02/04-06/13)  
Skoda Yeti (5L) (05/09-12/17)  
Volkswagen Bora V (Mex) (01/07--)  
Volkswagen Eos (03/06-08/15)  
Volkswagen Golf VI (5K1, 517, AJ5) (10/08-05/16)  
Volkswagen Scirocco III (137) (05/08-11/17)

Seat Leon II / Toledo III / Altea (1P\_ ,5P\_) (03/04--)  
Skoda Superb II (3T) (03/08-05/15)  
Volkswagen Beetle (5C1) (04/11-07/19)  
Volkswagen Caddy III (2KA, 2KB) (03/04-05/15)  
Volkswagen Golf V (1K1, 1K5, 5M1) (10/03-08/14)  
Volkswagen Jetta III (1K2) (09/04-12/13)  
Volkswagen Touran I ( 1T1/2/3) (02/03-05/15)



**Suspension Kit** **100 610 0068** **MCR0057**

**Notes**

Required quantity Front Axle Left  
 replacement in pairs recommended Front Axle Right  
2



**References**

- |                                |                              |
|--------------------------------|------------------------------|
| Audi 1K0 407 182               | Audi 1K0 407 182 A           |
| Audi 1K0 407 182 F             | Audi 3C0 199 231 D           |
| Audi 3C0 199 231 E             | Audi 5Q0 407 182             |
| Audi 5Q0 407 182 A             | Seat 1K0 407 182             |
| Seat 1K0 407 182 A             | Seat 1K0 407 182 F           |
| Seat 3C0 199 231 D             | Seat 3C0 199 231 E           |
| Seat 3C0 199 231 F             | Seat 5Q0 407 182 A           |
| Volkswagen 1K0 407 182         | Volkswagen 1K0 407 182 A     |
| Volkswagen 1K0 407 182 F       | Volkswagen 3C0 199 231 A     |
| Volkswagen 3C0 199 231 B       | Volkswagen 3C0 199 231 D     |
| Volkswagen 3C0 199 231 E       | Volkswagen 5Q0 407 182       |
| Volkswagen 5Q0 407 182 A       | Volkswagen (FAW) 1KD 407 182 |
| Volkswagen (FAW) 3C0 199 231 D | Volkswagen (FAW) 5Q0 407 182 |

**Application info**

- |  |   |
|--|---|
| Audi Q3 I (8U_) (06/11-12/18)              | Seat Alhambra II (710) (06/10--)        |
| Volkswagen Passat (362, 365) (08/10-12/15) | Volkswagen Passat (3C_) (03/05-01/12)   |
| Volkswagen Sharan (7N) (05/10--)           | Volkswagen Tiguan I (5N ) (09/07-07/18) |

**Suspension Kit** **100 610 0085/HD** **MCR0018HD**

**Notes**

Paired article number Carbon Neutral  
 Replace in pairs only Front Axle Left  
 Required quantity with accessories  
 reinforced version with rubber mount  
100 610 0086/HD | MCR0019HD  
1





**References**

Audi 1K0 199 231 G  
 Audi 1K0 199 231 K  
 Seat 1K0 199 231 K  
 Skoda (SVW) 1K0 199 231 J  
 Volkswagen 1K0 199 231 J  
 Volkswagen (FAW) 1K0 199 231

Audi 1K0 199 231 J  
 Seat 1K0 199 231 J  
 Skoda 1K0 199 231 J  
 Volkswagen 1K0 199 231 G  
 Volkswagen 1K0 199 231 K

**Application info**

Audi A3 II (8P\_) (05/03-12/15)  
 Skoda Octavia II (1Z\_) (02/04-06/13)  
 Skoda Yeti (5L) (05/09-12/17)  
 Volkswagen Bora V (Mex) (01/07--)  
 Volkswagen Eos (03/06-08/15)  
 Volkswagen Golf VI (5K1, 517, AJ5) (10/08-05/16)  
 Volkswagen Scirocco III (137) (05/08-11/17)

Seat Leon II / Toledo III / Altea (1P\_ ,5P\_) (03/04--)  
 Skoda Superb II (3T) (03/08-05/15)  
 Volkswagen Beetle (5C1) (04/11-07/19)  
 Volkswagen Caddy III (2KA, 2KB) (03/04-05/15)  
 Volkswagen Golf V (1K1, 1K5, 5M1) (10/03-08/14)  
 Volkswagen Jetta III (1K2) (09/04-12/13)  
 Volkswagen Touran I ( 1T1/2/3) (02/03-05/15)

**Suspension Kit****100 610 0086/HD****MCR0019HD****Notes**

Carbon Neutral  
 Front Axle Right  
 with accessories  
 with rubber mount

Paired article number  
 Replace in pairs only  
 Required quantity  
 reinforced version

100 610 0085/HD | MCR0018HD  
 1

**References**

Audi 1K0 199 232 G  
 Seat 1K0 199 232 J  
 Skoda (SVW) 1K0 199 232 J  
 Volkswagen 1K0 199 232 J

Audi 1K0 199 232 J  
 Skoda 1K0 199 232 J  
 Volkswagen 1K0 199 232 G  
 Volkswagen (FAW) 1K0 199 232 J

**Application info**

Audi A3 II (8P\_) (05/03-12/15)  
 Skoda Octavia II (1Z\_) (02/04-06/13)  
 Skoda Yeti (5L) (05/09-12/17)  
 Volkswagen Bora V (Mex) (01/07--)  
 Volkswagen Eos (03/06-08/15)  
 Volkswagen Golf VI (5K1, 517, AJ5) (10/08-05/16)  
 Volkswagen Scirocco III (137) (05/08-11/17)

Seat Leon II / Toledo III / Altea (1P\_ ,5P\_) (03/04--)  
 Skoda Superb II (3T) (03/08-05/15)  
 Volkswagen Beetle (5C1) (04/11-07/19)  
 Volkswagen Caddy III (2KA, 2KB) (03/04-05/15)  
 Volkswagen Golf V (1K1, 1K5, 5M1) (10/03-08/14)  
 Volkswagen Jetta III (1K2) (09/04-12/13)  
 Volkswagen Touran I ( 1T1/2/3) (02/03-05/15)

**Suspension Kit**

11-16 610 0002

MCR0090

**Notes**

Front Axle Left  
Front Axle Right  
for control arm  
with ball joint  
with rubber mount

Required quantity  
replacement in pairs recommended

2



**References**

Citroën 3520.W7  
Citroën 3520.X1  
Citroën 3521.S9  
Citroën 3521.T3  
Citroën 3523 CZ  
Citroën 3523 EC  
Citroën 3523.CN  
Citroën 3640.77  
Citroën 98 032 865 80  
DS 3520 X1  
DS 3520.W7  
DS 3521 T3  
DS 3521.S9  
DS 3523 EC  
DS 98 032 865 80  
Peugeot 3523.CR  
Peugeot 96 707 714 80  
Peugeot 98 032 864 80

Citroën 3520.W8  
Citroën 3520.Y1  
Citroën 3521.T0  
Citroën 3521.V2  
Citroën 3523 EA  
Citroën 3523 EE  
Citroën 3523.CP  
Citroën 98 032 864 80  
DS 3520 W8  
DS 3520 Y1  
DS 3521 T0  
DS 3521 V2  
DS 3523 CZ  
DS 98 032 864 80  
Peugeot 3523 CN  
Peugeot 3640.77  
Peugeot 96 707 720 80  
Peugeot 98 032 865 80

**Application info**

Citroën C3 II (09/09--)  
Citroën C4 Cactus (09/14--)  
DS DS 3 (04/15-07/19)  
Peugeot 208 I (03/12--)

Citroën C3 III (07/16--)  
Citroën DS3 (11/09-12/16)  
Peugeot 2008 I (03/13--)

<b>Suspension Kit</b>	<b>11-16 610 0003/HD</b>	<b>MCR0091HD</b>
-----------------------	--------------------------	------------------

<p><b>Notes</b></p> <p>Carbon Neutral Front Axle Left Front Axle Right for control arm with ball joint with rubber mount</p> <p>Replace in pairs only Required quantity reinforced version</p>	<p>2</p>	
--	----------	---

<p><b>References</b></p> <p>Peugeot 1215144 Peugeot 3520.F1 Peugeot 3521.A1 Peugeot 3640.48 Peugeot 3840.37</p>	<p>Peugeot 1215145 Peugeot 3521.69 Peugeot 3523.75 Peugeot 3640.49</p>
---	--

<p><b>Application info</b></p> <p>Peugeot 306 (01/93-10/03)</p>
---

<b>Suspension Kit</b>	<b>11-16 610 0004/HD</b>	<b>MCR0092HD</b>
-----------------------	--------------------------	------------------

<p><b>Notes</b></p> <p>Carbon Neutral Front Axle Left Front Axle Right for control arm with ball joint with rubber mount</p> <p>Replace in pairs only Required quantity reinforced version</p>	<p>2</p>	
--	----------	---

**References**

Citroën 16 072 975 80  
 Citroën 3520.F7  
 Citroën 3521.A7  
 Citroën 3523.75  
 Citroën 3640.51  
 Citroën 95 685 512  
 Citroën 96 110 483  
 Peugeot 1215144  
 Peugeot 16 07 297 580  
 Peugeot 3520.H5  
 Peugeot 3523.75  
 Peugeot 3640.51

Citroën 16 072 976 80  
 Citroën 3520.F8  
 Citroën 3521.A8  
 Citroën 3640.50  
 Citroën 3640.52  
 Citroën 95 685 513  
 Citroën 96 111 043  
 Peugeot 1215145  
 Peugeot 16 07 297 680  
 Peugeot 3521.E5  
 Peugeot 3640.50

**Application info**

Citroën Berlingo I (07/96-12/11)  
 Citroën Xsara Picasso (09/99-06/12)  
 Peugeot Partner II (04/08--)

Citroën Xsara (04/97-03/10)  
 Peugeot Partner I (05/96--)

**Suspension Kit**

11-16 610 0005

MCR0093

**Notes**

Required quantity  
 replacement in pairs recommended

Front Axle Left  
 Front Axle Right  
 for control arm  
 with ball joint  
 with rubber mount  
 2



**References**

Citroën 16 072 984 80  
 Citroën 16 073 050 80  
 Citroën 3520 Q9  
 Citroën 3520.W5  
 Citroën 3521.N8  
 Citroën 3523.CC  
 Citroën 3640.56  
 Citroën 3640.61  
 Citroën 3640.65  
 Citroën 98 105 881 80  
 DS 98 105 881 80  
 Peugeot 16 07 298 480  
 Peugeot 16 073 050 80  
 Peugeot 3520 Q9  
 Peugeot 3520 W5  
 Peugeot 3521 N0  
 Peugeot 3521 S8  
 Peugeot 3523.CC  
 Peugeot 3640.56  
 Peugeot 3640.61  
 Peugeot 3640.65  
 Peugeot 98 10 588 180

Citroën 16 072 985 80  
 Citroën 16 073 051 80  
 Citroën 3520.R7  
 Citroën 3521 N0  
 Citroën 3521.S8  
 Citroën 3523.CE  
 Citroën 3640.59  
 Citroën 3640.62  
 Citroën 3640.66  
 Citroën 98 105 882 80  
 DS 98 105 882 80  
 Peugeot 16 07 298 580  
 Peugeot 16 073 051 80  
 Peugeot 3520 T1  
 Peugeot 3520.R7  
 Peugeot 3521 Q2  
 Peugeot 3521.N8  
 Peugeot 3523.CE  
 Peugeot 3640.59  
 Peugeot 3640.62  
 Peugeot 3640.66  
 Peugeot 98 10 588 280

**Application info**

Citroën C3 III (07/16--)  
 Citroën C4 Cactus (09/14--)  
 DS DS 3 (04/15-07/19)  
 Peugeot 207 (02/06--)

Citroën C3 Picasso (02/09--)  
 Citroën DS3 (11/09-12/16)  
 Peugeot 2008 I (03/13--)  
 Peugeot 208 I (03/12--)

**Suspension Kit**

11-16 610 0006

MCR0094

**Notes**

Front Axle Left  
 Front Axle Right  
 for control arm  
 with ball joint  
 with rubber mount  
 2

Required quantity  
 replacement in pairs recommended



**References**

Citroën 16 072 984 80  
 Citroën 3520.T2  
 Citroën 3520.T6  
 Citroën 3520.T8  
 Citroën 3521 Q3  
 Citroën 3521 Q7  
 Citroën 3521 Q9  
 Citroën 3523 CZ  
 Citroën 3523 EC  
 Citroën 3523.CN  
 Citroën 3640.56  
 Citroën 3640.61  
 Citroën 3640.65  
 Peugeot 16 07 298 480  
 Peugeot 3520.T2  
 Peugeot 3521 Q3  
 Peugeot 3523 CN  
 Peugeot 3640.56  
 Peugeot 3640.61  
 Peugeot 3640.65  
 Peugeot 96 707 714 80

Citroën 16 072 985 80  
 Citroën 3520.T5  
 Citroën 3520.T7  
 Citroën 3520.T9  
 Citroën 3521 Q6  
 Citroën 3521 Q8  
 Citroën 3521 R0  
 Citroën 3523 EA  
 Citroën 3523 EE  
 Citroën 3523.CP  
 Citroën 3640.59  
 Citroën 3640.62  
 Citroën 3640.66  
 Peugeot 16 07 298 580  
 Peugeot 3520.T3  
 Peugeot 3521 Q4  
 Peugeot 3523.CR  
 Peugeot 3640.59  
 Peugeot 3640.62  
 Peugeot 3640.66  
 Peugeot 96 707 720 80

**Application info**

Citroën C2 / C3 I / Pluriel (02/02--)

Peugeot 1007 (04/05--)

**Suspension Kit**

11-16 610 0007/HD

MCR0095HD

**Notes**

Carbon Neutral  
 Control Arm  
 Front Axle Left  
 Front Axle Right  
 Lower  
 Sheet Steel  
 for vehicles with power steering  
 with ball joint  
 with rubber mount

Replace in pairs only  
 Required quantity reinforced version

2



**References**

Peugeot 16 144 470 80  
 Peugeot 3520.84  
 Peugeot 3520.99  
 Peugeot 3520.H3  
 Peugeot 3521.55  
 Peugeot 3521.68  
 Peugeot 3521.E4

Peugeot 16 144 473 80  
 Peugeot 3520.98  
 Peugeot 3520.F3  
 Peugeot 3520.H4  
 Peugeot 3521.56  
 Peugeot 3521.E3  
 Peugeot 3521.E5

**Application info**

Peugeot 306 (01/93-10/03)

**Suspension Kit**

11-16 610 0008

MCR0096

**Notes**

Front Axle Left  
 Front Axle Right  
 for control arm  
 with ball joint  
 with rubber mount

Required quantity  
 replacement in pairs recommended

2



**References**

Citroën 96 783 112 80  
 Citroën 98 463 292 80  
 Peugeot 96 721 924 80  
 Peugeot 96 78 311 380  
 Peugeot 98 079 142 80  
 Peugeot 98 203 816 80  
 Peugeot 98 463 292 80

Citroën 96 783 113 80  
 Citroën 98 463 297 80  
 Peugeot 96 78 311 280  
 Peugeot 98 079 141 80  
 Peugeot 98 203 815 80  
 Peugeot 98 310 882 80  
 Peugeot 98 463 297 80

**Application info**

Citroën C4 Grand Picasso II (01/13--)  
 Citroën C4 SPACETOURER / GRAND SPACETOURER  
 (04/18--)  
 Peugeot 308 II (09/13--)  
 Peugeot 508 II (09/18--)

Citroën C4 II / DS4 (02/09--)  
 Peugeot 308 I (09/07--)  
 Peugeot 308 III (07/21--)

Suspension Kit		11-16 610 0009	MCR0064
<p><b>Notes</b></p> <p>Front Axle Right Left for control arm with ball joint with rubber mount</p> <p>Required quantity replacement in pairs recommended</p> <p>1</p>			
<p><b>References</b></p> <p>Citroën 3520.Q2 Peugeot 3520.Q2 Toyota 48068-0H010</p> <p>Citroën 3521.L3 Peugeot 3521.L3 Toyota 48069-0H010</p>			
<p><b>Application info</b></p> <p>Citroën C1 (06/05-09/14) Toyota Aygo I (02/05-05/14)</p> <p>Peugeot 107 (06/05-05/14)</p>			

Suspension Kit		11-16 610 0010	MCR0065
<p><b>Notes</b></p> <p>Front Axle Left Front Axle Right for control arm with ball joint with rubber mount</p> <p>Required quantity replacement in pairs recommended</p> <p>2</p>			



**References**

- |                       |                 |
|-----------------------|-----------------|
| Citroën 16 227 103 80 | Citroën 3520 L3 |
| Citroën 3520.L4       | Citroën 3520.L9 |
| Citroën 3520.N1       | Citroën 3520.P9 |
| Citroën 3520.Q0       | Citroën 3520.R0 |
| Citroën 3520.R1       | Citroën 3520.R2 |
| Citroën 3520.R3       | Citroën 3520.R4 |
| Citroën 3520.R5       | Citroën 3520.V1 |
| Citroën 3520.V5       | Citroën 3521 H5 |
| Citroën 3521 J2       | Citroën 3521 L1 |
| Citroën 3521 N1       | Citroën 3521 N2 |
| Citroën 3521 N3       | Citroën 3521 N4 |
| Citroën 3521 N5       | Citroën 3521 N6 |
| Citroën 3521 S2       | Citroën 3521.H6 |
| Citroën 3521.J1       | Citroën 3521.K8 |
| Citroën 3521.R2       | Peugeot 3520.P1 |
| Peugeot 3520.R6       | Peugeot 3521 N7 |
| Peugeot 3521.K1       |                 |

**Application info**

- |                                       |                        |
|---------------------------------------|------------------------|
| Citroën C2 / C3 I / Pluriel (02/02--) | Peugeot 1007 (04/05--) |
|---------------------------------------|------------------------|

**Suspension Kit**

114 653 0000

MCR0022

**Notes**

- Front Axle Left
  - Front Axle Right
  - Lower
- Required quantity 2

replacement in pairs recommended



**References**

- |                               |                               |
|-------------------------------|-------------------------------|
| Mercedes-Benz 903 330 41 07   | Mercedes-Benz 906 330 40 07   |
| Mercedes-Benz 906 333 00 14   | Mercedes-Benz 906 333 01 14   |
| Mercedes-Benz A 903 330 41 07 | Mercedes-Benz A 906 330 40 07 |
| Mercedes-Benz A 906 333 00 14 | Mercedes-Benz A 906 333 01 14 |
| Volkswagen 2E0 407 151 M      | Volkswagen 2E0 407 152 M      |
| Volkswagen 2E0 407 523        | Volkswagen 2E0 407 523 A      |

**DRIVER'S BEST FRIEND**

**MEYLE**

**Application info**

Mercedes-Benz BM 906 (Sprinter II) (06/06--)

Volkswagen Crafter I (2E) (04/06-12/16)

Mercedes-Benz BM 907 / 910 (Sprinter III) (02/18--)

## Steering

## Axial rod

15-16 030 0003

MAR0089

## Notes

Front Axle Left  
Front Axle Right

Length [mm] 283  
Required quantity 2  
Thread Size 1 M14x1,5  
Thread Size 2 M12x1,5  
replacement in pairs recommended



## References

Alfa Romeo 9944452  
Alfa Romeo 9947368

Alfa Romeo 9947361  
Fiat 994 44 52

## Application info

Alfa Romeo 145 / 146 (07/94-10/01)  
Alfa Romeo GTV (09/94-10/05)  
Fiat Coupé (11/93-08/00)

Alfa Romeo 155 (01/92-12/97)  
Alfa Romeo Spider (916) (09/94-04/05)

## Axial rod

15-16 031 0002

MAR0091

## Notes

Front Axle Left  
Front Axle Right

Length [mm] 220  
Required quantity 2  
Thread Size 1 M16x1,5  
Thread Size 2 M14x1,5  
replacement in pairs recommended



## References

Alfa Romeo 9948297

Alfa Romeo 9948905

## Application info

Alfa Romeo 166 (09/98-06/07)

## Axial rod

15-16 031 0005

MAR0094

## Notes

Front Axle Left  
Front Axle Right

Length [mm] 213  
Required quantity 2  
Thread Size 1 M16x1,5  
Thread Size 2 M20x1,5  
replacement in pairs recommended



## References

Alfa Romeo 50515292  
Alfa Romeo 60693687  
Alfa Romeo 71794275

Alfa Romeo 51880991  
Alfa Romeo 71793496  
Alfa Romeo 77363705

## Application info

Alfa Romeo 159 (06/05-12/12)  
Alfa Romeo Spider (939) (03/06-03/11)

Alfa Romeo Brera (01/06-05/11)

## Axial rod

16-16 030 0000

MAR0095

## Notes

Front Axle Left  
Front Axle Right

Length [mm] 218  
Required quantity 2  
Thread Size 1 M12x1  
Thread Size 2 M14x1,5  
replacement in pairs recommended





## References



Renault 7701472766

Renault 7701478551

## Application info

Renault Laguna II (03/01-12/07)

Axial rod		16-16 030 0006	MAR0098
<b>Notes</b>  Front Axle Left Front Axle Right  Length [mm] 255 Required quantity 2 Thread Size 1 M12x1 Thread Size 2 M14x1,5 replacement in pairs recommended			
<b>References</b> Renault 7700759418 Renault 7702145337		Renault 7701463346	
<b>Application info</b> Renault R 19 (01/88-08/03) Renault Super 5 (10/84-12/96)		Renault Rapid/Express (07/85-10/99)	
Axial rod		16-16 030 0023	MAR0100
<b>Notes</b>  Front Axle Left Front Axle Right  Length [mm] 303 Required quantity 2 Thread Size 1 M12x1 Thread Size 2 M14x1,5 replacement in pairs recommended			
<b>References</b> Renault 7701477878			
<b>Application info</b> Renault Twingo II / Wind (03/07--)			

Axial rod		16-16 030 4298	MAR0101
<b>Notes</b>  Front Axle Left Front Axle Right  Length [mm] 270 Required quantity 2 Thread Size 1 M12x1 Thread Size 2 M14x1,5 replacement in pairs recommended			
<b>References</b> Renault 7701465915 Renault 7701467235		Renault 7701465917 Renault 7701467237	
<b>Application info</b> Renault R 19 (01/88-08/03)		Renault R 21 (03/86-07/97)	
Axial rod		16-16 030 7046	MAR0102
<b>Notes</b>  Front Axle Left Front Axle Right  Length [mm] 298 Required quantity 2 Thread Size 1 M12x1 Thread Size 2 M14x1,5 replacement in pairs recommended			
<b>References</b> Renault 7701467218 Renault 7701469517		Renault 7701467219	
<b>Application info</b> Renault Twingo I (03/93-10/12)			

**Axial rod**

16-16 030 7056

MAR0103

**Notes**

Front Axle Left  
Front Axle Right

Length [mm] 266  
Required quantity 2  
Thread Size 1 M12x1  
Thread Size 2 M14x1,5  
replacement in pairs recommended

**References**

Renault 7701469251

Renault 7701469665

**Application info**

Renault Laguna I (11/93-08/02)

**Axial rod**

16-16 031 0000

MAR0104

**Notes**

Front Axle Left  
Front Axle Right  
for vehicles with power steering

Length [mm] 242  
Manufacturer Restriction SMI  
Required quantity 2  
Thread Size 1 M12x1  
Thread Size 2 M14x1,5  
replacement in pairs recommended

**References**

Renault 7701471125

**Application info**

Renault Clio I (05/90-09/98)

Renault Clio II / Thalia (02/98--)

**Axial rod**

16-16 031 0001

MAR0105

**Notes**

Front Axle Left  
 Front Axle Right  
 for vehicles with power steering

Length [mm] 294  
 Manufacturer Restriction SMI  
 Required quantity 2  
 Thread Size 1 M12x1  
 Thread Size 2 M14x1,5  
 replacement in pairs recommended

**References**

Renault 7701471844

**Application info**

Renault Mégane I / Scénic I (08/95-07/10)

**Axial rod**

16-16 031 0002

MAR0106

**Notes**

Front Axle Left  
 Front Axle Right  
 for vehicles with power steering

Length [mm] 259  
 Manufacturer Restriction SMI  
 Required quantity 2  
 Thread Size 1 M12x1  
 Thread Size 2 M14x1,5  
 replacement in pairs recommended

**References**

Renault 7701468953

Renault 7701469502

**Application info**

Renault Mégane I / Scénic I (08/95-07/10)



**Axial rod****16-16 031 0003/HD****MAR0107HD****Notes**

Carbon Neutral  
 Front Axle Left  
 Front Axle Right

Length [mm] 193  
 Required quantity 2  
 Thread Size 1 M12x1  
 Thread Size 2 M14x1,5  
 reinforced version  
 replacement in pairs recommended

**References**

Dacia 6001547606  
 Lada 6001550441  
 Renault 6001550441

Dacia 6001550441  
 Renault 6001547606

**Application info**

Dacia Logan I (08/04--)  
 Dacia Sandero I (06/08--)  
 Lada Largus (03/12--)  
 Renault Sandero/Stepway I (11/07--)

Dacia Logan II (10/12--)  
 Dacia Sandero II (10/12--)  
 Renault Logan I (09/04--)

**Axial rod****16-16 031 0004****MAR0108****Notes**

Front Axle Left  
 Front Axle Right

Length [mm] 263  
 Required quantity 2  
 Thread Size 1 M12x1  
 Thread Size 2 M14x1,5  
 replacement in pairs recommended

**References**

Fiat 6000617147  
 Nissan 48520-00QAM  
 Renault 7701473333  
 Vauxhall 91 16 0037

GENERAL MOTORS 91160037  
 Opel 44 08 474  
 Vauxhall 44 08 474

**Application info**

Fiat Talento (06/16--)  
 Nissan Primastar I (X83) (03/01--)  
 Opel Vivaro A (08/01--)  
 Renault Trafic II (03/01--)  
 Vauxhall Vivaro A (08/01-07/14)

Nissan NV300 (09/16--)  
 Nissan Primastar II (X82) (11/21--)  
 Opel Vivaro B (06/14--)  
 Renault Trafic III (05/14--)  
 Vauxhall Vivaro B (05/14--)

**Axial rod****16-16 031 0005****MAR0109****Notes**

Front Axle Left  
 Front Axle Right

Length [mm] 248  
 Required quantity 2  
 Thread Size 1 M12x1  
 Thread Size 2 M14x1,5  
 replacement in pairs recommended

**References**

Citroën 3812.F6  
 Renault 7701474076

DS 3812 F6  
 Renault 7701478552

**Application info**

Citroën C3 II (09/09--)  
 DS DS 3 (04/15-07/19)  
 Renault Vel Satis (06/02--)

Citroën DS3 (11/09-12/16)  
 Renault Espace IV (11/02--)

**Axial rod****16-16 031 0006****MAR0110****Notes**

Front Axle Left  
 Front Axle Right

Length [mm] 215  
 Required quantity 2  
 Thread Size 1 M14x1,5  
 Thread Size 2 M14x1,5  
 replacement in pairs recommended

**References**

Mazda D653-32-240

Renault 7701474448

**Application info**

Mazda 2 (DE) (07/07-06/15)  
Renault Scénic II (06/03-07/10)

Renault Mégane II (07/01--)

**Axial rod**

16-16 031 0007

MAR0111

**Notes**

Front Axle Left  
Front Axle Right

Length [mm] 309  
Required quantity 2  
Thread Size 1 M14x1,5  
Thread Size 2 M14x1,5  
replacement in pairs recommended

**References**

Nissan 48001AX702  
Nissan 48001BC43A  
Renault 7701475841

Nissan 48001AY612  
Nissan 48001BC46A

**Application info**

Nissan Micra (K12) (03/02--)

Renault Clio III / Modus (09/04--)

**Axial rod**

16-16 031 0008

MAR0112

**Notes**

Front Axle Left  
Front Axle Right

Length [mm] 303  
Manufacturer Restriction SMI  
Required quantity 2  
Thread Size 1 M12x1  
Thread Size 2 M14x1,5  
replacement in pairs recommended

**References**

Nissan 48521-00QAG  
Renault 7701473655

Renault 7701472120

**Application info**

Nissan Kubistar (08/03--)  
Renault Kangoo I (08/97--)

Renault Clio II / Thalia (02/98--)

**Axial rod**

16-16 031 0009

MAR0113

**Notes**

Front Axle Left  
 Front Axle Right  
 for vehicles with power steering

Length [mm] 285  
 Manufacturer Restriction TRW  
 Required quantity 2  
 Thread Size 1 M14x1,5  
 Thread Size 2 M14x1,5  
 replacement in pairs recommended

**References**

Renault 7701472087

Renault 7701472089

Renault 7701476760

**Application info**

Renault Mégane I / Scénic I (08/95-07/10)

**Axial rod**

16-16 031 0010

MAR0114

**Notes**

Front Axle Left  
 Front Axle Right

Length [mm] 242  
 Manufacturer Restriction TRW  
 Required quantity 2  
 Thread Size 1 M12x1  
 Thread Size 2 M14x1,5  
 replacement in pairs recommended

**References**

Renault 7701471124

**Application info**

Renault Clio II / Thalia (02/98--)

**Axial rod**

16-16 031 0011

MAR0115

**Notes**

Front Axle Left  
Front Axle Right

Length [mm] 303  
Manufacturer Restriction TRW  
Required quantity 2  
Thread Size 1 M12x1  
Thread Size 2 M14x1,5  
replacement in pairs recommended

**References**

Nissan 48521-00QAA

Renault 7701472113

**Application info**

Nissan Kubistar (08/03--)  
Renault Kangoo I (08/97--)

Renault Clio II / Thalia (02/98--)

**Axial rod**

16-16 031 0013/HD

MAR0496HD

**Notes**

Carbon Neutral  
Front Axle Left  
Front Axle Right

Length [mm] 215  
Required quantity 2  
Thread Size 1 M14x1,5  
Thread Size 2 M14x1,5  
reinforced version  
replacement in pairs recommended

**References**

Mazda D653-32-240

Renault 7701474448

**Application info**

Mazda 2 (DE) (07/07-06/15)  
Renault Scénic II (06/03-07/10)

Renault Mégane II (07/01--)

## Axial rod

16-16 031 0014

MAR0116

## Notes

Front Axle Left  
Front Axle Right

Length [mm] 207  
Required quantity 2  
Thread Size 1 M14x1,5  
Thread Size 2 M14x1,5  
replacement in pairs recommended



## References

Mercedes-Benz 415 320 00 89  
Renault 485215612R  
Renault 7701478406

Mercedes-Benz A 415 320 00 89  
Renault 485215961R

## Application info

Mercedes-Benz BM 415 (Citan) (11/12--)  
Renault Kangoo II (02/08--)  
Renault Mégane II (07/01--)

Renault Fluence (02/10--)  
Renault Megane III (11/08--)  
Renault Scénic III (12/08--)

## Axial rod

16-16 031 0016/HD

MAR0118HD

## Notes

Carbon Neutral  
Front Axle Left  
Front Axle Right

Length [mm] 255  
Required quantity 2  
Thread Size 1 M12x1  
Thread Size 2 M14x1,5  
reinforced version  
replacement in pairs recommended



## References



Renault 6025370493

Renault 6025370494

## Application info

Renault Avantime (09/01-05/03)

Renault Espace III (11/96-10/02)

Axial rod		16-16 031 0017	MAR0119
<b>Notes</b>  Front Axle Left Front Axle Right  Length [mm] 190 Required quantity 2 Thread Size 1 M14x1,5 Thread Size 2 M14x1,5 replacement in pairs recommended			
<b>References</b> Renault 485210001R			
<b>Application info</b> Renault Laguna III / Coupe / Grandtour (10/07-12/15)			
Axial rod		16-16 031 0019	MAR0121
<b>Notes</b>  Front Axle Left Front Axle Right  Length [mm] 205 Required quantity 2 Thread Size 1 M16x1,5 Thread Size 2 M14x1,5 replacement in pairs recommended			
<b>References</b> Dacia 8201108350 Renault 8201108350			
<b>Application info</b> Dacia Duster I (04/10--) Renault Duster I (01/11--)			

**Axial rod**

16-16 031 0020

MAR0122

**Notes**

Front Axle Left  
Front Axle Right

Length [mm] 250  
Required quantity 2  
Thread Size 1 M16x1,5  
Thread Size 2 M18x1,5  
replacement in pairs recommended

**References**

GENERAL MOTORS 93167687  
Opel 44 20 096  
Vauxhall 44 20 096

Nissan 48521-00Q0E  
Renault 485212373R  
Vauxhall 93 16 7687

**Application info**

Nissan Interstar II (X62B) (11/21--)  
Opel Movano B (05/10--)  
Vauxhall Movano Mk II (05/10--)

Nissan NV400 (11/11--)  
Renault Master III (02/10--)

**Axial rod**

16-16 031 0022

MAR0123

**Notes**

Front Axle Left  
Front Axle Right

Length [mm] 320  
Required quantity 2  
Thread Size 1 M12x1  
Thread Size 2 M14x1,5  
replacement in pairs recommended

**References**

Renault 7701473498

**Application info**

Renault Twingo I (03/93-10/12)



**Axial rod**

16-16 031 0024

MAR0125

**Notes**

Front Axle Left  
Front Axle Right

Length [mm] 291  
 Manufacturer Restriction TRW  
 Required quantity 2  
 Thread Size 1 M14x1,5  
 Thread Size 2 M14x1,5  
 replacement in pairs recommended

**References**

Renault 7701472734

Renault 7701472735

**Application info**

Renault Clio II / Thalia (02/98--)

**Axial rod**

16-16 031 0025

MAR0359

**Notes**

Front Axle Left  
Front Axle Right

Length [mm] 230  
 Required quantity 2  
 Thread Size 1 M16x1,5  
 Thread Size 2 M14x1,5  
 replacement in pairs recommended

**References**

Renault 485211071R

Renault 485211375R

**Application info**

Renault Captur I (06/13--)  
Renault Zoe (06/12--)

Renault Clio IV (11/12--)

**Axial rod****16-16 031 0026****MAR0360****Notes**Front Axle Left  
Front Axle Right

Length [mm]

190

Required quantity

2

Thread Size 1

M14x1,5

Thread Size 2

M14x1,5

replacement in pairs recommended

**References**

Dacia 485211105R

Dacia 485213172R

Renault 485211105R

Renault 485213172R

**Application info**

Dacia Dokker (11/12--)

Dacia Lodgy (03/12--)

Dacia Logan II (10/12--)

Dacia Sandero II (10/12--)

Renault Dokker (12/13--)

Renault Express (05/21--)

Renault Lodgy (JS\_) (07/13--)

Renault Logan I (09/04--)

Renault Logan II (09/12--)

Renault Sandero/Stepway II (11/13--)

Renault Thalia III (12/13--)

**Axial rod****16-16 031 0033/HD****MAR0497HD****Notes**Carbon Neutral  
Front Axle Left  
Front Axle Right

Length [mm]

309

Required quantity

2

Thread Size 1

M14x1,5

Thread Size 2

M14x1,5

reinforced version

replacement in pairs recommended

**References**

Nissan 48001AX702

Nissan 48001AY612

Nissan 48001BC43A

Nissan 48001BC46A

Renault 7701475841

**Application info**

Nissan Micra (K12) (03/02--)

Renault Clio III / Modus (09/04--)

**Axial rod**

16-16 031 0034/HD

MAR0498HD

**Notes**

Carbon Neutral  
 Front Axle Left  
 Front Axle Right

Length [mm] 320  
 Required quantity 2  
 Thread Size 1 M12x1  
 Thread Size 2 M14x1,5  
 reinforced version  
 replacement in pairs recommended

**References**

Renault 7701473498

**Application info**

Renault Twingo I (03/93-10/12)

**Axial rod**

16-16 031 0037/HD

MAR0501HD

**Notes**

Carbon Neutral  
 Front Axle Left  
 Front Axle Right

Length [mm] 263  
 Required quantity 2  
 Thread Size 1 M12x1  
 Thread Size 2 M14x1,5  
 reinforced version  
 replacement in pairs recommended

**References**

Fiat 6000617147

Nissan 48520-00QAM

Renault 7701473333

GENERAL MOTORS 91160037

Opel 44 08 474

Vauxhall 44 08 474

**Application info**

Fiat Talento (06/16--)

Nissan Primastar I (X83) (03/01--)

Opel Vivaro A (08/01--)

Renault Trafic II (03/01--)

Vauxhall Vivaro A (08/01-07/14)

Nissan NV300 (09/16--)

Nissan Primastar II (X82) (11/21--)

Opel Vivaro B (06/14--)

Renault Trafic III (05/14--)

Vauxhall Vivaro B (05/14--)

**Axial rod**

16-16 031 0038/HD

MAR0502HD

**Notes**

Carbon Neutral  
 Front Axle Left  
 Front Axle Right

Length [mm]

205

Required quantity

2

Thread Size 1

M16x1,5

Thread Size 2

M14x1,5

reinforced version

replacement in pairs recommended

**References**

Dacia 8201108350

Renault 8201108350

**Application info**

Dacia Duster I (04/10--)

Renault Duster I (01/11--)

**Axial rod**

16-16 031 0039/HD

MAR0503HD

**Notes**

Carbon Neutral  
 Front Axle Left  
 Front Axle Right

Length [mm]

303

Required quantity

2

Thread Size 1

M12x1

Thread Size 2

M14x1,5

reinforced version

replacement in pairs recommended

**References**

Renault 7701477878

**Application info**

Renault Twingo II / Wind (03/07--)

**Axial rod****16-16 031 0040/HD****MAR0504HD****Notes**Carbon Neutral  
Front Axle Left  
Front Axle Right

Length [mm]

190

Required quantity

2

Thread Size 1

M14x1,5

Thread Size 2

M14x1,5

reinforced version

replacement in pairs recommended

**References**

Dacia 485211105R

Dacia 485213172R

Renault 485211105R

Renault 485213172R

**Application info**

Dacia Dokker (11/12--)

Dacia Lodgy (03/12--)

Dacia Logan II (10/12--)

Dacia Sandero II (10/12--)

Renault Dokker (12/13--)

Renault Express (05/21--)

Renault Lodgy (JS\_) (07/13--)

Renault Logan I (09/04--)

Renault Logan II (09/12--)

Renault Sandero/Stepway II (11/13--)

Renault Thalia III (12/13--)

**Axial rod****16-16 031 0041/HD****MAR0543HD****Notes**Carbon Neutral  
Front Axle Left  
Front Axle Right

Length [mm]

207

Required quantity

2

Thread Size 1

M14x1,5

Thread Size 2

M14x1,5

reinforced version

replacement in pairs recommended

**References**

Mercedes-Benz 415 320 00 89

Mercedes-Benz A 415 320 00 89

Renault 485215612R

Renault 485215961R

Renault 7701478406

**Application info**

Mercedes-Benz BM 415 (Citan) (11/12--)  
 Renault Kangoo II (02/08--)  
 Renault Mégane II (07/01--)

Renault Fluence (02/10--)  
 Renault Megane III (11/08--)  
 Renault Scénic III (12/08--)

**Axial rod****16-16 031 0042/HD****MAR0591HD****Notes**

Carbon Neutral  
 Front Axle Left  
 Front Axle Right

Length [mm]

393

Required quantity

2

Thread Size 1

M12x1

Thread Size 2

M14X1,5

reinforced version

replacement in pairs recommended

**References**

Renault 485215653R  
 Smart A 453 463 00 00

Smart 453 463 00 00

**Application info**

Renault Twingo III (09/14--)  
 Smart Fortwo III (07/14--)

Smart Forfour II (07/14--)

**Axial rod****16-16 031 0043/HD****MAR0560HD****Notes**

Carbon Neutral  
 Front Axle Left  
 Front Axle Right

Length [mm]

210

Required quantity

2

Thread Size 1

14x1,5

Thread Size 2

14X1,5

reinforced version

replacement in pairs recommended

**References**

Renault 485216564R

**Application info**

Renault Megane IV (11/15--)

Renault Scenic / Grand Scenic IV (09/16--)

**Axial rod** **16-16 031 0044/HD** **MAR0633HD****Notes**

Carbon Neutral  
Front Axle Left  
Front Axle Right

Length [mm]

214

Required quantity

2

Thread Size 1

M16X1,5

Thread Size 2

M14x1,5

reinforced version

replacement in pairs recommended

**References**

Nissan 48001-4EH0A

Nissan 48001-4EH0B

Renault 485212518R

**Application info**

Nissan Qashqai II (J11\_) (11/13--)

Renault Kadjar (06/15--)

**Axial rod** **16-16 031 0045** **MAR0582****Notes**

Front Axle Left  
Front Axle Right

Length [mm]

232

Required quantity

2

Thread Size 1

M14x1,5

Thread Size 2

M14,1,5

replacement in pairs recommended





**References**

Renault 485212309R



**Application info**



Renault Espace V (02/15--)



Renault Talisman (06/15--)





Axial rod		16-16 031 0046/HD	MAR0573HD
<b>Notes</b>  Carbon Neutral Front Axle Left Front Axle Right  Length [mm] 214 Required quantity 2 Thread Size 1 M14x1,5 Thread Size 2 M14x1,5 reinforced version replacement in pairs recommended		 	
<b>References</b> Dacia 485213285R		Renault 485213285R	
<b>Application info</b> Dacia Duster II (10/17--) Renault Duster II (10/17--)		Renault Arkana (08/19--)	
Axial rod		18-16 031 0000	MAR0357
<b>Notes</b>  Front Axle Left Front Axle Right  Length [mm] 295 Required quantity 2 Thread Size 1 13/16"-20UNF Thread Size 2 M14x1,5 replacement in pairs recommended		 	
<b>References</b> Jaguar JLM409			
<b>Application info</b> Jaguar XJS (09/73-09/97)			



Axial rod		18-16 031 0001	MAR0443
<b>Notes</b>  Front Axle Left Front Axle Right  Length [mm] 210 Required quantity 2 Thread Size 1 M16x1,5 Thread Size 2 M14x1,5 replacement in pairs recommended			
<b>References</b> Jaguar C2D28554 Jaguar C2D44327 Jaguar C2D47149 Jaguar C2Z2214 Jaguar C2Z2215			
<b>Application info</b> Jaguar F-Type (10/12--) Jaguar XJ (X351) (10/09--) Jaguar XF I (X250) (03/08--) Jaguar XK (03/06-12/14)			
Axial rod		18-16 031 0002	MAR0557
<b>Notes</b>  Front Axle Left Front Axle Right  Length [mm] 201 Required quantity 2 Thread Size 1 M16x1,5 Thread Size 2 M14x1,5 replacement in pairs recommended			
<b>References</b> Jaguar T2H21418 Jaguar T2H32619 Jaguar T2H4205 Jaguar T2H5049			
<b>Application info</b> Jaguar XE (X760) (03/15--) Jaguar XF II (X260) (05/15--) 			

Axial rod		18-16 031 0003	MAR0558
<b>Notes</b>  Front Axle Left Front Axle Right  Length [mm] 208 Required quantity 2 Thread Size 1 M16x1,5 Thread Size 2 M14x1,5 replacement in pairs recommended			
<b>References</b> Jaguar T4A12526 Land Rover LR090900		Jaguar T4A12527	
<b>Application info</b> Jaguar F-Pace (X761) (09/15--) Land Rover Range Rover Velar (03/17--)		Jaguar I-Pace (X590) (02/18--)	
Axial rod		214 030 4686	MAR0126
<b>Notes</b>  Front Axle Left Front Axle Right for vehicles with power steering  Length [mm] 264 Required quantity 2 Thread Size 1 M16x1,5 Thread Size 2 M12x1,5 replacement in pairs recommended			
<b>References</b> Fiat 9945562		Lancia 994 5562	
<b>Application info</b> Fiat Punto I (09/93-06/00)		Lancia Y (11/95-09/03)	

Axial rod		216 020 0027	MAR0368
<b>Notes</b>  Front Axle Left Front Axle Right  Length [mm] 324 Required quantity 2 Thread Size 1 M18X1.5 Thread Size 2 M15x1.5 replacement in pairs recommended			
<b>References</b> Chrysler 68028831AA Chrysler 68028831AC		Chrysler 68028831AB	
<b>Application info</b> Chrysler 300 C (09/04--)			
Axial rod		216 030 3100	MAR0128
<b>Notes</b>  Front Axle Left Front Axle Right for vehicles without power steering  Length [mm] 272 Required quantity 2 Thread Size 1 M14x1,5 Thread Size 2 M12x1,5 replacement in pairs recommended			
<b>References</b> Fiat 7701491 Fiat 9946948		Fiat 9 948 343 Lancia 9946948	
<b>Application info</b> Fiat Barchetta (03/95-05/05) Fiat Punto II (09/99-07/12)		Fiat Punto I (09/93-06/00) Lancia Y (11/95-09/03)	

Axial rod		216 031 0003	MAR0132
<b>Notes</b>  Front Axle Left Front Axle Right  Length [mm] 300 Required quantity 2 Thread Size 1 M14x1,5 Thread Size 2 M14x1,5 replacement in pairs recommended		 	
<b>References</b> Lancia 9948296			
<b>Application info</b> Lancia Lybra (07/99-10/05)			
Axial rod		216 031 0008	MAR0137
<b>Notes</b>  Front Axle Left Front Axle Right  Length [mm] 226 Required quantity 2 Thread Size 1 M14x1,5 Thread Size 2 M12x1,5 replacement in pairs recommended		 	
<b>References</b> Fiat 77362506			
<b>Application info</b> Fiat Panda II (09/03--)			

**Axial rod**

216 031 0012

MAR0141

**Notes**

Front Axle Left  
 Front Axle Right  
 for vehicles with power steering

Length [mm] 296

Required quantity 2

Thread Size 1 M16x1,5

Thread Size 2 M14x1,5

replacement in pairs recommended

**References**

Fiat 98845026

**Application info**

Fiat Doblo (119, 223) (11/00--)

**Axial rod**

216 031 0016

MAR0145

**Notes**

Front Axle Left  
 Front Axle Right

Length [mm] 250

Required quantity 2

Thread Size 1 M14x1,5

Thread Size 2 M12x1,5

replacement in pairs recommended

**References**

Fiat 51786814

Fiat 51786815

Fiat 51875886

Fiat 51875887

Ford 1 541 354

Ford 1 541 355

Ford 9S51-3A500-AA



Ford 9S51-3A500-BA



**Application info**





ABARTH 500 (01/08--)

Fiat 500 (07/07--)



Ford KA II (10/08-05/16)



Axial rod		216 031 0017	MAR0146
<b>Notes</b>  Front Axle Left Front Axle Right  Length [mm] 272 Required quantity 2 Thread Size 1 M14x1,5 Thread Size 2 M14x1,5 replacement in pairs recommended			
<b>References</b> Citroën 4001 K6 Citroën 4001 NZ Citroën 4001 PA Citroën 4001.77 Fiat 9940260 Lancia 9940260 Lancia 9941186 Peugeot 4001 77 Peugeot 4001 K6 Peugeot 4001 NZ Peugeot 4001 PA			
<b>Application info</b> Citroën Nemo (02/08--) Fiat Croma I (12/85-12/96) Fiat Fiorino Nuovo (225) (01/07--) Fiat Linea (10/06--) Lancia Thema I (11/84-07/94) Peugeot Bipper (02/08--)			
Axial rod		216 031 0018	MAR0147
<b>Notes</b>  Front Axle Left Front Axle Right  Length [mm] 330 Required quantity 2 Thread Size 1 M16x1,5 Thread Size 2 M16x1,5 replacement in pairs recommended			
<b>References</b> Alfa Romeo 50519427 Alfa Romeo 50521026 Alfa Romeo 50521639 Alfa Romeo 50526421 Alfa Romeo 50547666			
<b>Application info</b> Alfa Romeo Giulietta (940) (04/10--)			

Axial rod		216 031 0020	MAR0149
<b>Notes</b>  Front Axle Left Front Axle Right  Length [mm] 300 Required quantity 2 Thread Size 1 M18x1,5 Thread Size 2 M14x1,5 replacement in pairs recommended			
<b>References</b> Fiat 26144989 Fiat 51854419 Fiat 51854420 Fiat 51885794 Fiat 51885795 Fiat 51885796 Fiat 51885797 Fiat 51938732			
<b>Application info</b> Fiat Doblo (263) (11/09--) Opel Combo D (02/12--) 			
Axial rod		216 031 0021	MAR0376
<b>Notes</b>  Front Axle Left Front Axle Right  Length [mm] 308 Required quantity 2 Thread Size 1 M14x1,5 Thread Size 2 M14x1,5 replacement in pairs recommended			
<b>References</b> Fiat K68040223AA Fiat K68040223AB Fiat K68040223AD Fiat K68040223AE Lancia K68040223AD Lancia K68040223AE			
<b>Application info</b> Fiat Freemont (JC) (08/11--) Lancia Flavia (03/12-12/14)			

Axial rod		216 031 0026/HD	MAR0505HD
<b>Notes</b>  Carbon Neutral Front Axle Left Front Axle Right  Length [mm] 250 Required quantity 2 Thread Size 1 M14x1,5 Thread Size 2 M12x1,5 reinforced version replacement in pairs recommended		 	
<b>References</b> Fiat 51786814 Fiat 51786815 Fiat 51875886 Fiat 51875887 Ford 1 541 354 Ford 1 541 355 Ford 9S51-3A500-AA Ford 9S51-3A500-BA			
<b>Application info</b> ABARTH 500 (01/08--) Ford KA II (10/08-05/16) Fiat 500 (07/07--)			
Axial rod		216 031 0027/HD	MAR0506HD
<b>Notes</b>  Carbon Neutral Front Axle Left Front Axle Right for vehicles with power steering  Length [mm] 296 Required quantity 2 Thread Size 1 M16x1,5 Thread Size 2 M14x1,5 reinforced version replacement in pairs recommended		 	
<b>References</b> Fiat 98845026			
<b>Application info</b> Fiat Doblo (119, 223) (11/00--)			



Axial rod		216 031 0028/HD	MAR0507HD
<b>Notes</b>  Carbon Neutral Front Axle Left Front Axle Right  Length [mm] 330 Required quantity 2 Thread Size 1 M16x1,5 Thread Size 2 M14x1,5 reinforced version replacement in pairs recommended			
<b>References</b> Fiat 98845024		Fiat 98845025	
<b>Application info</b> Fiat Doblo (119, 223) (11/00-- )			
Axial rod		216 031 0029/HD	MAR0508HD
<b>Notes</b>  Carbon Neutral Front Axle Left Front Axle Right  Length [mm] 252 Required quantity 2 Thread Size 1 M14x1,5 Thread Size 2 M12x1,5 reinforced version replacement in pairs recommended			
<b>References</b> Lancia 51706968 Lancia 51893013		Lancia 51832250 Lancia 77362380	
<b>Application info</b> Lancia Ypsilon (843) (10/03-12/11)			

Axial rod		216 031 0030/HD	MAR0509HD
<b>Notes</b>			
	Carbon Neutral		
	Front Axle Left		
	Front Axle Right		
Length [mm]	272		
Required quantity	2		
Thread Size 1	M14x1,5		
Thread Size 2	M14x1,5		
reinforced version			
replacement in pairs recommended			
<b>References</b>			
Citroën 4001 K6		Citroën 4001 NZ	
Citroën 4001 PA		Citroën 4001.77	
Fiat 9940260		Lancia 9940260	
Peugeot 4001 77		Peugeot 4001 K6	
Peugeot 4001 NZ		Peugeot 4001 PA	
<b>Application info</b>			
Citroën Nemo (02/08--)		Fiat Cromia I (12/85-12/96)	
Fiat Fiorino Nuovo (225) (01/07--)		Fiat Linea (10/06--)	
Lancia Thema I (11/84-07/94)		Peugeot Bipper (02/08--)	
Axial rod		216 031 0031/HD	MAR0544HD
<b>Notes</b>			
	Carbon Neutral		
	Front Axle Left		
	Front Axle Right		
Length [mm]	288		
Required quantity	2		
Thread Size 1	M14x1,5		
Thread Size 2	M14X1,5		
reinforced version			
replacement in pairs recommended			
<b>References</b>			
Fiat 51885439		Fiat 51909794	
<b>Application info</b>			
Fiat 500L (09/12--)			

**Axial rod**

216 031 0032/HD

MAR0574HD

**Notes**

Carbon Neutral  
 Front Axle Left  
 Front Axle Right  
 Length [mm] 234  
 Required quantity 2  
 Thread Size 1 M14x1,5  
 Thread Size 2 M12x1,5  
 reinforced version  
 replacement in pairs recommended



**References**

Fiat 51907994	Fiat 51965753
Fiat 51965755	Fiat 6810 5871 AB
Fiat K68105871AA	Fiat K68105871AB
Lancia 51965753	Lancia 51965755

**Application info**

Fiat Panda III (02/12--)	Lancia Ypsilon (846) (05/11--)
--------------------------	--------------------------------

**Axial rod**

216 031 0033/HD

MAR0634HD

**Notes**

Carbon Neutral  
 Front Axle Left  
 Front Axle Right  
 Length [mm] 298  
 Required quantity 2  
 Thread Size 1 M14X1,5  
 Thread Size 2 M14X1,5  
 reinforced version  
 replacement in pairs recommended



**References**

Fiat 51967456	Fiat 52005180
Jeep 51967456	Jeep 52005180

**Application info**

Fiat 500X (09/14--)	Jeep Renegade (BU, B1) (07/14--)
---------------------	----------------------------------

**Axial rod**

216 031 0034

MAR0638

**Notes**

	Front Axle Left
	Front Axle Right
Length [mm]	331
Required quantity	2
Thread Size 1	M18X1,5
Thread Size 2	M16X1,5
replacement in pairs recommended	

**References**

Iveco 4256 9566

**Application info**

Iveco Daily VI (03/14--)

**Axial rod**

216 031 0035/HD

MAR0648HD

**Notes**

	Carbon Neutral
	Front Axle Left
	Front Axle Right
Length [mm]	326.5
Required quantity	2
Thread Size 1	M16X1,5
Thread Size 2	M16X1,5
replacement in pairs recommended	

**References**

Iveco 4253 2977

**Application info**

Iveco Daily III (11/97-10/09)

Iveco Daily IV (05/06-03/12)

**Axial rod****216 031 0036****MAR0667****Notes**

Front Axle Left  
Front Axle Right

Length [mm] 298  
Required quantity 2  
Thread Size 1 M14x1,5  
Thread Size 2 M14x1,5  
replacement in pairs recommended

**References**

ABARTH 52169265  
ABARTH 52225924  
Fiat 52169676

ABARTH 52169676  
Fiat 52169265  
Fiat 52225924

**Application info**

ABARTH 500E (02/23--)

Fiat 500e (332\_) (10/20--)

**Axial rod****28-16 031 0011****MAR0156****Notes**

Front Axle Left  
Front Axle Right

Length [mm] 162  
Required quantity 2  
Thread Size 1 M16x1,5  
Thread Size 2 M14x1,5  
replacement in pairs recommended

**References**

Hyundai 56540-2H000

Kia 56540 2H000

**Application info**

Hyundai Elantra IV (09/05--)  
Kia Cee'd I (12/06-02/13)

Hyundai i30 I (10/07-06/12)  
Kia Cerato II (TD) (01/09--)

**Axial rod**

28-16 031 0015

MAR0562

**Notes**

Front Axle Left

Length [mm]

188

Paired article number

28-16 031 0016 | MAR0563

Required quantity

1

Thread Size 1

M18x1,5

Thread Size 2

M16x1,5

replacement in pairs recommended

**References**

Kia 57724 2P100

**Application info**

Kia Sorento II (06/09--)

**Axial rod**

28-16 031 0016

MAR0563

**Notes**

Front Axle Right

Length [mm]

188

Paired article number

28-16 031 0015 | MAR0562

Required quantity

1

Thread Size 1

M18x1,5

Thread Size 2

M16x1,5





replacement in pairs recommended

**References**

Kia 57724 2P000

**Application info**

Kia Sorento II (06/09--)

Axial rod		28-16 031 0024/HD	MAR0511HD
<b>Notes</b>  Carbon Neutral Front Axle Left Front Axle Right  Length [mm] 162 Required quantity 2 Thread Size 1 M16x1,5 Thread Size 2 M14x1,5 reinforced version replacement in pairs recommended		 	
<b>References</b> Hyundai 56540-2H000		Kia 56540 2H000	
<b>Application info</b> Hyundai Elantra IV (09/05--) Kia Cee'd I (12/06-02/13)		Hyundai i30 I (10/07-06/12) Kia Cerato II (TD) (01/09--)	
Axial rod		28-16 031 0025/HD	MAR0512HD
<b>Notes</b>  Carbon Neutral Front Axle Left Front Axle Right  Length [mm] 170 Required quantity 2 Thread Size 1 M18x1,5 Thread Size 2 M14x1,5 reinforced version replacement in pairs recommended		 	
<b>References</b> Kia 57731 3E010		Kia 57732 3E010	
<b>Application info</b> Kia Sorento I (08/02--)			

**Axial rod**

28-16 031 0026/HD

MAR0513HD

**Notes**

Carbon Neutral  
 Front Axle Left  
 Front Axle Right

Length [mm]

290

Required quantity

2

Thread Size 1

M16x1,5

Thread Size 2

M12x1,25

reinforced version

replacement in pairs recommended

**References**

Kia 57724 07000

Kia 57724 07001

Kia 57724 07100

Kia 57724 07101

**Application info**

Kia Picanto I (04/04--)

**Axial rod**

28-16 031 0028/HD

MAR0620HD

**Notes**

Carbon Neutral  
 Front Axle Left  
 Front Axle Right

Length [mm]

198.1

Required quantity

2

Thread Size 1

M16X1,5

Thread Size 2

M14X1,5

reinforced version

replacement in pairs recommended

**References**

Kia 56540 G6000

**Application info**

Kia Picanto III (03/17--)



**Axial rod**

28-16 031 0029/HD

MAR0650HD

**Notes**

Carbon Neutral  
 Front Axle Left  
 Front Axle Right

Length [mm]

278

Required quantity

2

Thread Size 1

M16X1,5

Thread Size 2

M14X1,5

reinforced version

replacement in pairs recommended

**References**

Hyundai 56540-H8000

Kia 56540 H8000

Kia 56540 H8100

**Application info**

Hyundai Accent V (01/18--)

Hyundai Solaris (01/17--)

Kia Rio IV (01/17--)

Kia Stonic (07/17--)

**Axial rod**

28-16 031 0031/HD

MAR0610HD

**Notes**

Carbon Neutral  
 Front Axle Left  
 Front Axle Right

Length [mm]

223

Observe service information

Required quantity

2

Thread Size 1

18x1,5

Thread Size 2

16x1,5

replacement in pairs recommended

**References**

Kia 57724 D4000

**Application info**

Kia Optima IV (09/15--)

**Axial rod****28-16 031 0032/HD****MAR0571HD****Notes**

Carbon Neutral  
 Front Axle Left  
 Front Axle Right

Length [mm]

253

Required quantity

2

Thread Size 1

M16x1,5

Thread Size 2

M16X1,5

reinforced version

replacement in pairs recommended

**References**

Kia 57724 C5100

Kia 57724 C5600

**Application info**

Kia Sorento III (01/15--)

Kia Sorento IV (03/20--)

**Axial rod****28-16 031 0033/HD****MAR0566HD****Notes**

Carbon Neutral  
 Front Axle Left  
 Front Axle Right

Length [mm]

243

Required quantity

2

Thread Size 1

M16x1,5

Thread Size 2

M16x1,5

reinforced version

replacement in pairs recommended



**References**

Kia 57724 C5000

Kia 57724 C5500

**Application info**

Kia Sorento III (01/15--)

Axial rod		28-16 031 0034/HD	MAR0645HD
<b>Notes</b>  Carbon Neutral Front Axle Left Front Axle Right  Length [mm] 230 Required quantity 2 Thread Size 1 M16X1,5 Thread Size 2 M16X1,5 reinforced version replacement in pairs recommended			
<b>References</b> Hyundai 57724-3Z000 Hyundai 57724-C1000		Hyundai 57724-3Z100 Kia 57724 C1000	
<b>Application info</b> Hyundai Sonata VII (06/14--) Kia Optima IV (09/15--)		Hyundai i40 (07/11--)	
Axial rod		28-16 031 0035	MAR0607
<b>Notes</b>  Front Axle Left Front Axle Right  Length [mm] 187 Required quantity 2 Thread Size 1 20x1,5 Thread Size 2 14x1,5 replacement in pairs recommended			
<b>References</b> Kia 57724 1Y500		Kia 57724 1Y501	
<b>Application info</b> Kia Picanto II (05/11--)			

**Axial rod**

28-16 031 0036

MAR0646

**Notes**Front Axle Left  
Front Axle Right

Length [mm]

186

Required quantity

2

Thread Size 1

M16X1,5

Thread Size 2

M14X1,5

replacement in pairs recommended

**References**

Kia 57724 1Y600

**Application info**

Kia Picanto II (05/11--)

**Axial rod**

28-16 031 0037/HD

MAR0615HD

**Notes**Carbon Neutral  
Front Axle Left  
Front Axle Right

Length [mm]

208

Observe service information

Required quantity

2

Thread Size 1

M16X1,5

Thread Size 2

M16x1,5

replacement in pairs recommended

**References**

Kia 57724 A4000

**Application info**

Kia Carens IV (03/13--)

## Axial rod

29-16 031 0002

MAR0158

## Notes

Front Axle Left  
Front Axle Right

Length [mm] 358  
Required quantity 2  
Thread Size 1 M16x1,5  
Thread Size 2 M14x1,5  
replacement in pairs recommended



## References

Chevrolet 520808  
Chevrolet 93740701  
Daewoo 93740701

Chevrolet 93740618  
Daewoo 520808  
Daewoo 95710894

## Application info

Chevrolet Epica (01/05--)  
Chevrolet Lacetti (03/03--)  
Daewoo Lacetti (02/02--)

Chevrolet Evanda (03/05--)  
Daewoo Evanda / Magnus (08/02--)  
Daewoo Leganza (03/97-04/04)

## Axial rod

29-16 031 0006

MAR0161

## Notes

Front Axle Left  
Front Axle Right

Length [mm] 200  
Required quantity 2  
Thread Size 1 M16x1,5  
Thread Size 2 M12x1,5  
replacement in pairs recommended



## References

Chevrolet 96425093  
Daewoo 96535300

Chevrolet 96535300

## Application info

Chevrolet Astro I (02/03-05/08)  
Daewoo Kalos (09/02--)

Chevrolet Aveo I (01/03--)

**Axial rod**

29-16 031 0007/HD

MAR0621HD

**Notes**

Carbon Neutral  
 Front Axle Left  
 Front Axle Right

Length [mm]

244.5

Required quantity

2

Thread Size 1

M14x1,5

Thread Size 2

M12x1,25

reinforced version

replacement in pairs recommended

**References**

Chevrolet 95967277

Chevrolet 95967294

**Application info**

Chevrolet Spark (M300) (12/09--)

**Axial rod**

29-16 031 0008/HD

MAR0637HD

**Notes**

Carbon Neutral  
 Front Axle Left  
 Front Axle Right

Length [mm]

328

Required quantity

2

Thread Size 1

M16X1,5

Thread Size 2

M14X1,5

reinforced version

replacement in pairs recommended

**References**

CHEVROLET (SGM) 95218372

Chevrolet 95218372

**Application info**

Chevrolet Aveo II (03/11--)

**Axial rod**

29-16 031 0009/HD

MAR0625HD

**Notes**

Carbon Neutral  
 Front Axle Left  
 Front Axle Right  
 for vehicles without electric power steering

Length [mm]

303.1

Required quantity

2

Thread Size 1

M16X1,5

Thread Size 2

M16X1,5

reinforced version

replacement in pairs recommended

**References**

Chevrolet 13314170

**Application info**

Chevrolet Orlando (J309) (12/10--)

**Axial rod**

30-16 030 0009

MAR0164

**Notes**

Front Axle Left  
 Front Axle Right

Length [mm]

240

Manufacturer Restriction

ZF

Required quantity

2

Thread Size 1

M14x1,5

Thread Size 2

M14x1,5

replacement in pairs recommended



**References**

Toyota 45503-05010

Toyota 45503-990DL

**Application info**

Toyota Carina (T19) (02/92-09/97)

Axial rod		30-16 030 0011	MAR0165
<b>Notes</b>  Front Axle Left Front Axle Right  Length [mm] 318 Required quantity 2 Thread Size 1 M14x1,5 Thread Size 2 M14x1,5 replacement in pairs recommended			
<b>References</b> Toyota 45503-19175 Toyota 45503-19215 Toyota 45503-29365			
<b>Application info</b> Toyota Corolla (E10) (06/91-12/99) Toyota Corolla (E11) (06/95-06/02) Toyota Corolla (E9) (05/87-04/97) Toyota RAV 4 I (01/94-09/00)			
Axial rod		30-16 031 0010	MAR0177
<b>Notes</b>  Front Axle Left Front Axle Right  Length [mm] 305 Required quantity 2 Thread Size 1 M14x1,5 Thread Size 2 M16x1,5 replacement in pairs recommended			
<b>References</b> Toyota 45503-0F010 Toyota 45503-20170			
<b>Application info</b> Toyota Avensis (T25) (01/03-11/08) Toyota Corolla Verso (03/04-04/09)			



**Axial rod**

30-16 031 0028/HD

MAR0178HD

**Notes**

Carbon Neutral  
 Front Axle Left  
 Front Axle Right

Length [mm] 294  
 Required quantity 2  
 Thread Size 1 M14x1,5  
 Thread Size 2 M15x1,5  
 reinforced version  
 replacement in pairs recommended

**References**

Toyota 45503-09320  
 Toyota 45503-09331  
 Toyota 45503-09410

Toyota 45503-09321  
 Toyota 45503-09340

**Application info**

Toyota Hilux (KUN) (08/04--)

**Axial rod**

30-16 031 0029/HD

MAR0514HD

**Notes**

Carbon Neutral  
 Front Axle Left  
 Front Axle Right

Length [mm] 305  
 Required quantity 2  
 Thread Size 1 M14x1,5  
 Thread Size 2 M16x1,5  
 reinforced version  
 replacement in pairs recommended

**References**

Toyota 45503-0F010

Toyota 45503-20170

**Application info**

Toyota Avensis (T25) (01/03-11/08)

Toyota Corolla Verso (03/04-04/09)

**Axial rod**

30-16 031 0031

MAR0664

**Notes**

	Front Axle Left
	Front Axle Right
Length [mm]	296
Required quantity	2
Thread Size 1	M14x1,5
Thread Size 2	M16x1,5
replacement in pairs recommended	

**References**

Toyota 45503-0K130

**Application info**

Toyota Fortuner (\_N15\_, \_N16\_) (05/15--)

Toyota Hilux (Gun1, Gun13) (05/15--)

Toyota Hilux VIII (\_N1\_) (05/15--)

**Axial rod**

30-16 031 0059/HD

MAR0179HD

**Notes**

	Carbon Neutral
	Front Axle Left
	Front Axle Right
Length [mm]	240
Required quantity	2
Thread Size 1	M14x1,5
Thread Size 2	M14x1,5
reinforced version	
replacement in pairs recommended	

**References**

Toyota 45500-0D110

Toyota 45500-0D111

Toyota 45503-0D080

Toyota 45503-52070

**Application info**

Toyota Yaris II (01/05-12/14)

**Axial rod**

30-16 031 0075

MAR0182

**Notes**

Front Axle Left  
Front Axle Right

Length [mm]

240

Required quantity

2

Thread Size 1

M14x1,5

Thread Size 2

M12x1,25

replacement in pairs recommended

**References**

Toyota 45503-0D030

Toyota 45503-52010

Toyota 45503-59045

**Application info**

Toyota Yaris I (01/99-12/05)

**Axial rod**

30-16 031 0084/HD

MAR0551HD

**Notes**

Carbon Neutral  
Front Axle Left  
Front Axle Right

Length [mm]

261

Required quantity

2

Thread Size 1

M24x1,5

Thread Size 2

M16x1,5

reinforced version

replacement in pairs recommended

**References**

Lexus 45503-60040

Toyota 45503-60040

**Application info**

Lexus GX II (11/09--)

Toyota Land Cruiser (J15) (07/09--)

**Axial rod**

31-16 030 0019

MAR0188

**Notes**

Front Axle Left

Length [mm]

210

Paired article number

31-16 030 0020 | MAR0189

Required quantity

1

Thread Size 1

M20x1,5

Thread Size 2

M14x1,5

replacement in pairs recommended

**References**

Honda 53010-SMG-E01

**Application info**

Honda Civic VIII (09/05--)

**Axial rod**

31-16 030 0020

MAR0189

**Notes**

Front Axle Right

Length [mm]

210

Paired article number

31-16 030 0019 | MAR0188

Required quantity

1

Thread Size 1

M20x1,5

Thread Size 2

M14x1,5

replacement in pairs recommended

**References**

Honda 53011-SMG-E01

**Application info**

Honda Civic VIII (09/05--)

**Axial rod**

31-16 030 0021

MAR0190

**Notes**

	Front Axle Left
	Front Axle Right
Length [mm]	320
Required quantity	2
Thread Size 1	M20x1,5
Thread Size 2	M14x1,5
replacement in pairs recommended	

**References**

Honda 53010-SWA-A01

**Application info**

Honda CR-V III (06/06--)

Honda Civic V (10/91-02/01)

Honda Civic VI (06/95-03/01)

**Axial rod**

31-16 031 0009/HD

MAR0516HD

**Notes**

	Carbon Neutral
	Front Axle Left
	Front Axle Right
Length [mm]	122
Required quantity	2
Thread Size 1	M18x1,5
Thread Size 2	M14x1,5
reinforced version	
replacement in pairs recommended	

**References**

Honda 53010-SDA-A01

Honda 53010-SEA-900

**Application info**

Honda Accord VIII (09/02--)

**Axial rod**

31-16 031 0010/HD

MAR0517HD

**Notes**

Carbon Neutral  
 Front Axle Left  
 Front Axle Right

Length [mm]

202

Required quantity

2

Thread Size 1

M12x1,25

Thread Size 2

M14 x1,25

reinforced version

replacement in pairs recommended

**References**

Honda 53010-S10-000

**Application info**

Honda CR-V I (10/95-07/02)

**Axial rod**

31-16 031 0033/HD

MAR0606HD

**Notes**

Carbon Neutral  
 Front Axle Left  
 Front Axle Right

Length [mm]

250

Required quantity

2

Thread Size 1

14x1,5

Thread Size 2

14x1,5

reinforced version

replacement in pairs recommended

**References**

Honda 53410-T5B-003

**Application info**

Honda HR-V II (11/14--)

Honda Jazz IV (09/13--)

**Axial rod**

31-16 031 0034/HD

MAR0647HD

**Notes**

Carbon Neutral  
 Front Axle Left  
 Front Axle Right

Length [mm]

255

Required quantity

2

Thread Size 1

M16X1,0

Thread Size 2

M14X1,5

reinforced version

replacement in pairs recommended

**References**

Honda 53010-T0A-A01

**Application info**

Honda CR-V IV (01/12--)

Honda CR-V V (12/16--)

**Axial rod**

31-16 031 0035/HD

MAR0644HD

**Notes**

Carbon Neutral  
 Front Axle Left  
 Front Axle Right

Length [mm]

270

Required quantity

2

Thread Size 1

M14X1,5

Thread Size 2

M14X1,5

reinforced version

replacement in pairs recommended

**References**

Honda 53010-T7W-003

**Application info**

Honda HR-V II (11/14--)

**Axial rod**

31-16 031 0036

MAR0622

**Notes**

Front Axle Left  
Front Axle Right

Length [mm]

196.5

Required quantity

2

Thread Size 1

M18X1,5

Thread Size 2

M14X1,5

replacement in pairs recommended

**References**

Honda 53521-TEA-A51

**Application info**

Honda Civic X (09/15--)

**Axial rod**

31-16 031 0038

MAR0597

**Notes**

Front Axle Left  
Front Axle Right

Length [mm]

182

Required quantity

2

Thread Size 1

20x1,5

Thread Size 2

14x1,5

replacement in pairs recommended

**References**

Honda 53010-TV0-E01

**Application info**

Honda Civic IX (09/11--)



**Axial rod**

31-16 031 0039

MAR0656

**Notes**

Front Axle Left  
Front Axle Right

Length [mm] 235.5  
Required quantity 2  
Thread Size 1 M18x1,5  
Thread Size 2 M14x1,5  
replacement in pairs recommended

**References**

Honda 53010-TF0-003

**Application info**

Honda Insight II (04/09--)

Honda Jazz III (10/07--)

**Tie rod assembly**

16-16 030 0032/HD

MTA0299HD

**Notes**

Front Axle Right  
Paired article number 16-16 030 0027/HD  
Paired article number 16-16 030 0033/HD | MTA0300HD  
Required quantity 1  
Thread Size 1 M10x1,25  
Thread Size 2 M12x1,0

reinforced version  
replacement in pairs recommended

**References**

GENERAL MOTORS 91160037  
GENERAL MOTORS 91160044  
Nissan 48203-00QAE  
Nissan 48520-00QAM  
Opel 44 08 511  
Opel 4408476  
Renault 77 01 473 334  
Renault 7701473333  
Vauxhall 91160044

GENERAL MOTORS 91160038  
GENERAL MOTORS 93198896  
Nissan 48520-00QAL  
Opel 44 08 474  
Opel 44 53 052  
Renault 485209446R  
Renault 7701049283  
Vauxhall 44 08 474  
Vauxhall 93198896

**Application info**

Nissan Primastar I (X83) (03/01--)  
 Opel Vivaro A (08/01--)  
 Renault Trafic II (03/01--)  
 Vauxhall Vivaro A (08/01-07/14)

Nissan Primastar II (X82) (11/21--)  
 Opel Vivaro B (06/14--)  
 Renault Trafic III (05/14--)  
 Vauxhall Vivaro B (05/14--)

**Tie rod assembly****16-16 030 0033/HD****MTA0300HD****Notes**

Front Axle Left

Paired article number  
 Required quantity  
 Thread Size 1  
 Thread Size 2  
 reinforced version  
 replacement in pairs recommended

1  
 M10x1,25  
 M12X1,0

**References**



GENERAL MOTORS 91160037  
 GENERAL MOTORS 91160043  
 Nissan 48203-00QAE  
 Nissan 48520-00QAM  
 Opel 44 08 510  
 Opel 4408476  
 Renault 77 01 473 334  
 Renault 7701473333  
 Vauxhall 91160043



GENERAL MOTORS 91160038  
 GENERAL MOTORS 93198895  
 Nissan 48520-00QAK  
 Opel 44 08 474  
 Opel 44 53 051  
 Renault 485202714R  
 Renault 7701049282  
 Vauxhall 44 08 474  
 Vauxhall 93198895



**Application info**

Nissan Primastar I (X83) (03/01--)  
 Opel Vivaro A (08/01--)  
 Renault Trafic II (03/01--)  
 Vauxhall Vivaro A (08/01-07/14)

Nissan Primastar II (X82) (11/21--)  
 Opel Vivaro B (06/14--)  
 Renault Trafic III (05/14--)  
 Vauxhall Vivaro B (05/14--)

Tie rod assembly		16-16 030 4280	MTA0141
<b>Notes</b>  Front Axle Left Front Axle Right  Length [mm] 261 Required quantity 2 Thread Size 1 M10x1,25 Thread Size 2 M12x1 replacement in pairs recommended			
<b>References</b> Renault 6025171486 Renault 7701464313		Renault 7701463195 Renault 7701469229	
<b>Application info</b> Renault Espace II (01/91-10/97)		Renault R 25 (04/84-12/93)	
Tie rod assembly		16-16 030 7022	MTA0143
<b>Notes</b>  Front Axle Left Front Axle Right  Length [mm] 306 Required quantity 2 Thread Size 1 M10x1,25 Thread Size 2 M12x1 replacement in pairs recommended			
<b>References</b> Renault 7701463346			
<b>Application info</b> Renault Rapid/Express (07/85-10/99)		Renault Super 5 (10/84-12/96)	

Tie rod end		15-16 020 0001	MTE0175
<b>Notes</b>  Length [mm] 75 Paired article number 15-16 020 0002   MTE0176 Required quantity 1 Thread Size 1 M10x1,25 Thread Size 2 M14x1,5 replacement in pairs recommended			
<b>References</b> Alfa Romeo 9947920 Lancia 9947920		Alfa Romeo 9951289	
<b>Application info</b> Alfa Romeo 147 (10/00-12/10) Alfa Romeo 166 (09/98-06/07) Lancia Thesis (07/02-07/09)		Alfa Romeo 156 (02/97-05/06) Alfa Romeo GT (937) (11/03-09/10)	
Tie rod end		15-16 020 0002	MTE0176
<b>Notes</b>  Length [mm] 75 Paired article number 15-16 020 0001   MTE0175 Required quantity 1 Thread Size 1 M10x1,25 Thread Size 2 M14x1,5 replacement in pairs recommended			
<b>References</b> Alfa Romeo 9947919 Lancia 9947919		Alfa Romeo 9951288	
<b>Application info</b> Alfa Romeo 147 (10/00-12/10) Alfa Romeo 166 (09/98-06/07) Lancia Thesis (07/02-07/09)		Alfa Romeo 156 (02/97-05/06) Alfa Romeo GT (937) (11/03-09/10)	

Tie rod end		15-16 020 0004	MTE0178
<b>Notes</b>  Front Axle Left Length [mm] 115 Paired article number 15-16 020 0005   MTE0179 Required quantity 1 Thread Size 1 M12x1,75 Thread Size 2 M20x1,5 replacement in pairs recommended			
<b>References</b> Alfa Romeo 77363706			
<b>Application info</b> Alfa Romeo 159 (06/05-12/12) Alfa Romeo Brera (01/06-05/11) Alfa Romeo Spider (939) (03/06-03/11)			
Tie rod end		15-16 020 0005	MTE0179
<b>Notes</b>  Front Axle Right Length [mm] 115 Paired article number 15-16 020 0004   MTE0178 Required quantity 1 Thread Size 1 M12x1,75 Thread Size 2 M20x1,5 replacement in pairs recommended			
<b>References</b> Alfa Romeo 77363707			
<b>Application info</b> Alfa Romeo 159 (06/05-12/12) Alfa Romeo Brera (01/06-05/11) Alfa Romeo Spider (939) (03/06-03/11)			

## Tie rod end

15-16 020 0007

MTE0181

## Notes

Front Axle Right

Length [mm]

95

Paired article number

15-16 020 0008 | MTE0182

Required quantity

1

Thread Size 1

M12x1,5

Thread Size 2

M16x1,5

replacement in pairs recommended



## References

Alfa Romeo 50520353

Alfa Romeo 77365591

## Application info

Alfa Romeo Giulietta (940) (04/10--)

## Tie rod end

15-16 020 0008

MTE0182

## Notes

Front Axle Left

Length [mm]

95

Paired article number

15-16 020 0007 | MTE0181

Required quantity

1

Thread Size 1

M12x1,5

Thread Size 2

M16x1,5

replacement in pairs recommended



## References

Alfa Romeo 50520352

Alfa Romeo 77365592

## Application info

Alfa Romeo Giulietta (940) (04/10--)

## Tie rod end

15-16 020 0015/HD

MTE0981HD

## Notes

Carbon Neutral  
Front Axle Left  
Front Axle Right

Length [mm] 169  
Required quantity 2  
Thread Size 1 M12x1,5  
Thread Size 2 M14x1,5  
replacement in pairs recommended



## References

Alfa Romeo 77368151

## Application info

Alfa Romeo Stelvio (949) (12/16--)

## Tie rod end

16-16 020 0000

MTE0183

## Notes

Front Axle Right

Length [mm] 90  
Paired article number 16-16 020 0006 | MTE0187  
Required quantity 1  
Thread Size 1 M10x1,25  
Thread Size 2 M14x1,5  
replacement in pairs recommended



## References

Nissan 48520-00QAF  
Renault 485200151R  
Renault 7701047416  
Renault 7701474493  
Renault 7701474813  
Smart A 453 330 70 00

Nissan 48520-00QAP  
Renault 485208910R  
Renault 7701047813  
Renault 7701474642  
Smart 453 330 70 00

## Application info

Nissan Kubistar (08/03--)  
Renault Kangoo I (08/97--)  
Renault Twingo I (03/93-10/12)  
Renault Twingo III (09/14--)  
Smart Fortwo III (07/14--)

Renault Clio II / Thalia (02/98--)  
Renault Mégane I / Scénic I (08/95-07/10)  
Renault Twingo II / Wind (03/07--)  
Smart Forfour II (07/14--)

## Tie rod end

16-16 020 0006

MTE0187

## Notes

Front Axle Left

Length [mm]

90

Paired article number

16-16 020 0000 | MTE0183

Required quantity

1

Thread Size 1

M10x1,25

Thread Size 2

M14x1,5

replacement in pairs recommended



## References

Nissan 48520-00QAE

Nissan 48520-00QAN

Renault 485202478R

Renault 485204628R

Renault 7701047415

Renault 7701047812

Renault 7701474492

Renault 7701474641

Renault 7701474812

Smart 453 330 71 00

Smart A 453 330 71 00

## Application info

Nissan Kubistar (08/03--)

Renault Clio II / Thalia (02/98--)

Renault Kangoo I (08/97--)

Renault Mégane I / Scénic I (08/95-07/10)

Renault Twingo I (03/93-10/12)

Renault Twingo II / Wind (03/07--)

Renault Twingo III (09/14--)

Smart Forfour II (07/14--)

Smart Fortwo III (07/14--)

## Tie rod end

16-16 020 0008/HD

MTE0189HD

## Notes

Carbon Neutral

Front Axle Right

Length [mm]

210

Paired article number

16-16 020 0009/HD | MTE0190HD

Required quantity

1

Thread Size 1

M10x1,25

Thread Size 2

M14x1,5

reinforced version

replacement in pairs recommended





**References**

Fiat 6000617475

GENERAL MOTORS 93198896

Opel 44 08 511

Renault 485209446R

Vauxhall 91160044

GENERAL MOTORS 91160044

Nissan 48520-00QAL

Opel 44 53 052

Renault 7701049283

Vauxhall 93198896

**Application info**

Fiat Talento (06/16--)

Nissan Primastar I (X83) (03/01--)

Opel Vivaro A (08/01--)

Renault Espace IV (11/02--)

Renault Trafic II (03/01--)

Renault Vel Satis (06/02--)

Vauxhall Vivaro B (05/14--)

Nissan NV300 (09/16--)

Nissan Primastar II (X82) (11/21--)

Opel Vivaro B (06/14--)

Renault Laguna II (03/01-12/07)

Renault Trafic III (05/14--)

Vauxhall Vivaro A (08/01-07/14)

**Tie rod end****16-16 020 0009/HD****MTE0190HD****Notes**

Carbon Neutral

Front Axle Left

Length [mm]

210

Paired article number

16-16 020 0008/HD | MTE0189HD

Required quantity

1

Thread Size 1

M10x1,25

Thread Size 2

M14x1,5

reinforced version

replacement in pairs recommended

**References**

Fiat 6000617476

GENERAL MOTORS 93198895

Opel 44 08 510

Renault 485202714R

Vauxhall 91160043

GENERAL MOTORS 91160043

Nissan 48520-00QAK

Opel 44 53 051

Renault 7701049282

Vauxhall 93198895

**Application info**

Fiat Talento (06/16--)

Nissan Primastar I (X83) (03/01--)

Opel Vivaro A (08/01--)

Renault Espace IV (11/02--)

Renault Trafic II (03/01--)

Renault Vel Satis (06/02--)

Vauxhall Vivaro B (05/14--)

Nissan NV300 (09/16--)



Nissan Primastar II (X82) (11/21--)

Opel Vivaro B (06/14--)

Renault Laguna II (03/01-12/07)

Renault Trafic III (05/14--)

Vauxhall Vivaro A (08/01-07/14)

Tie rod end		16-16 020 0011	MTE0192
<b>Notes</b>  Front Axle Left Length [mm] 213 Paired article number 16-16 020 0012   MTE0193 Required quantity 1 Thread Size 1 M10x1,25 Thread Size 2 M14x1,5 replacement in pairs recommended			
<b>References</b> Dacia 485202867R Dacia 6001 547 610 Dacia 6001550442 Lada 6001550442 Renault 6001547610 Renault 6001550442			
<b>Application info</b> Dacia Dokker (11/12--) Dacia Logan I (08/04--) Dacia Sandero I (06/08--) Lada Largus (03/12--) Renault Express (05/21--) Renault Logan I (09/04--) Renault Sandero/Stepway I (11/07--) Renault Thalia III (12/13--) Dacia Lodgy (03/12--) Dacia Logan II (10/12--) Dacia Sandero II (10/12--) Renault Dokker (12/13--) Renault Lodgy (JS_) (07/13--) Renault Logan II (09/12--) Renault Sandero/Stepway II (11/13--) 			
Tie rod end		16-16 020 0011/HD	MTE0192HD
<b>Notes</b>  Carbon Neutral Front Axle Left Length [mm] 213 Paired article number 16-16 020 0012/HD   MTE0193HD Required quantity 1 Thread Size 1 M10x1,25 Thread Size 2 M14x1,5 reinforced version replacement in pairs recommended			
<b>References</b> Dacia 485202867R Dacia 6001547610 Dacia 6001550442 Renault 485202867R Renault 6001547610 Renault 6001550442			

**Application info**

Dacia Dokker (11/12--)	Dacia Lodgy (03/12--)
Dacia Logan I (08/04--)	Dacia Logan II (10/12--)
Dacia Sandero I (06/08--)	Dacia Sandero II (10/12--)
Lada Largus (03/12--)	Renault Dokker (12/13--)
Renault Express (05/21--)	Renault Lodgy (JS_) (07/13--)
Renault Logan I (09/04--)	Renault Logan II (09/12--)
Renault Sandero/Stepway I (11/07--)	Renault Sandero/Stepway II (11/13--)
Renault Thalia III (12/13--)	

**Tie rod end****16-16 020 0012/HD****MTE0193HD****Notes**

Carbon Neutral  
 Front Axle Right  
 Length [mm] 213  
 Paired article number 16-16 020 0011/HD | MTE0192HD  
 Required quantity 1  
 Thread Size 1 M10x1,25  
 Thread Size 2 M14x1,5

reinforced version  
 replacement in pairs recommended

**References**

Dacia 485200410R	Dacia 6001547611
Dacia 6001550443	Lada 8660003542
Lada 8660005229	Renault 485200410R
Renault 6001547611	Renault 6001550443

**Application info**

Dacia Dokker (11/12--)	Dacia Lodgy (03/12--)
Dacia Logan I (08/04--)	Dacia Logan II (10/12--)
Dacia Sandero I (06/08--)	Dacia Sandero II (10/12--)
Lada Largus (03/12--)	Renault Dokker (12/13--)
Renault Express (05/21--)	Renault Lodgy (JS_) (07/13--)
Renault Logan I (09/04--)	Renault Logan II (09/12--)
Renault Sandero/Stepway I (11/07--)	Renault Sandero/Stepway II (11/13--)
Renault Thalia III (12/13--)	

## Tie rod end

16-16 020 0012

MTE0193

## Notes

Front Axle Right

Length [mm]	213
Paired article number	16-16 020 0011   MTE0192
Required quantity	1
Thread Size 1	M10x1,25
Thread Size 2	M14x1,5
replacement in pairs recommended	



## References

Dacia 485200410R	Dacia 6001 547 611
Dacia 6001550443	Lada 6001550443
Lada 8660003542	Lada 8660005229
Renault 6001547611	Renault 6001550443

## Application info

Dacia Dokker (11/12--)	Dacia Lodgy (03/12--)
Dacia Logan I (08/04--)	Dacia Logan II (10/12--)
Dacia Sandero I (06/08--)	Dacia Sandero II (10/12--)
Lada Largus (03/12--)	Renault Dokker (12/13--)
Renault Express (05/21--)	Renault Lodgy (JS_) (07/13--)
Renault Logan I (09/04--)	Renault Logan II (09/12--)
Renault Sandero/Stepway I (11/07--)	Renault Sandero/Stepway II (11/13--)
Renault Thalia III (12/13--)	

## Tie rod end

16-16 020 0013/HD

MTE0194HD

## Notes

Carbon Neutral

Front Axle Left

Length [mm]	200
Paired article number	16-16 020 0015/HD   MTE0196HD
Required quantity	1
Thread Size 1	M10x1,25
Thread Size 2	M14x1,5
reinforced version	
replacement in pairs recommended	



## References

Renault 7701054583	Renault 7701054585
Renault 7701474795	

**Application info**

Renault Mégane II (07/01--)

Renault Scénic II (06/03-07/10)

**Tie rod end**

16-16 020 0013

MTE0194

**Notes**

Front Axle Left

Length [mm]

200

Paired article number

16-16 020 0015 | MTE0196

Required quantity

1

Thread Size 1

M10x1,25

Thread Size 2

M14x1,5

replacement in pairs recommended

**References**

Renault 7701054583

Renault 7701054585

Renault 7701474795

**Application info**

Renault Mégane II (07/01--)

Renault Scénic II (06/03-07/10)

**Tie rod end**

16-16 020 0014

MTE0195

**Notes**

Front Axle Left

Length [mm]

90

Paired article number

16-16 020 0016 | MTE0197

Required quantity

1

Thread Size 1

M10x1,25

Thread Size 2

M14x1,5

replacement in pairs recommended

**References**



Nissan 48640-AX602

Renault 7701475842

**Application info**

Nissan Micra (K12) (03/02--)

Renault Clio III / Modus (09/04--)

Tie rod end		16-16 020 0015	MTE0196
<b>Notes</b>  Length [mm] 200 Paired article number 16-16 020 0013   MTE0194 Required quantity 1 Thread Size 1 M10x1,25 Thread Size 2 M14x1,5 replacement in pairs recommended			
<b>References</b> Renault 7701054584		Renault 7701474796	
<b>Application info</b> Renault Mégane II (07/01--)		Renault Scénic II (06/03-07/10)	
Tie rod end		16-16 020 0015/HD	MTE0196HD
<b>Notes</b>  Length [mm] 200 Paired article number 16-16 020 0013/HD   MTE0194HD Required quantity 1 Thread Size 1 M10x1,25 Thread Size 2 M14x1,5 reinforced version replacement in pairs recommended			
<b>References</b> Renault 7701054584		Renault 7701474796	
<b>Application info</b> Renault Mégane II (07/01--)		Renault Scénic II (06/03-07/10)	

## Tie rod end

16-16 020 0016

MTE0197

## Notes

Front Axle Right

Length [mm]

90

Paired article number

16-16 020 0014 | MTE0195

Required quantity

1

Thread Size 1

M10x1,25

Thread Size 2

M14x1,5

replacement in pairs recommended



## References

Nissan 48520-AX602

Renault 7701475843

## Application info

Nissan Micra (K12) (03/02--)

Renault Clio III / Modus (09/04--)

## Tie rod end

16-16 020 0017

MTE0198

## Notes

Front Axle Left

Length [mm]

158

Paired article number

16-16 020 0018 | MTE0199

Required quantity

1

Thread Size 1

M10x1,25

Thread Size 2

M14x1,5

replacement in pairs recommended



## References





Renault 7701471126

Renault 7701471145



Renault 7701476762



## Application info



Renault Clio II / Thalia (02/98--)



Tie rod end		16-16 020 0018	MTE0199
<b>Notes</b>  Front Axle Right Length [mm] 158 Paired article number 16-16 020 0017   MTE0198 Required quantity 1 Thread Size 1 M10x1,25 Thread Size 2 M14x1,5 replacement in pairs recommended		 	
<b>References</b> Renault 7701471127 Renault 7701471146 Renault 7701476763			
<b>Application info</b> Renault Clio II / Thalia (02/98-- )			
Tie rod end		16-16 020 0019/HD	MTE0200HD
<b>Notes</b>  Carbon Neutral Front Axle Left Length [mm] 204 Paired article number 16-16 020 0020/HD   MTE0201HD Required quantity 1 Thread Size 1 M10x1,25 Thread Size 2 M14x1,5 reinforced version replacement in pairs recommended		 	
<b>References</b> Renault 6025370229			
<b>Application info</b> Renault Avantime (09/01-05/03) Renault Espace III (11/96-10/02)			







Tie rod end		16-16 020 0020/HD	MTE0201HD
<b>Notes</b>  Carbon Neutral Front Axle Right Length [mm] 204 Paired article number 16-16 020 0019/HD   MTE0200HD Required quantity 1 Thread Size 1 M10x1,25 Thread Size 2 M14x1,5 reinforced version replacement in pairs recommended			
<b>References</b> Renault 6025370230			
<b>Application info</b> Renault Avantime (09/01-05/03) Renault Espace III (11/96-10/02)			
Tie rod end		16-16 020 0021	MTE0202
<b>Notes</b>  Front Axle Right Length [mm] 200 Paired article number 16-16 020 0022   MTE0203 Required quantity 1 Thread Size 1 M10x1,25 Thread Size 2 M14x1,5 replacement in pairs recommended			
<b>References</b> Mercedes-Benz 415 460 01 05 Mercedes-Benz A 415 460 01 05 Renault 7701478408			
<b>Application info</b> Mercedes-Benz BM 415 (Citan) (11/12--) Renault Kangoo II (02/08--)			





Tie rod end		16-16 020 0022	MTE0203
<b>Notes</b>  Front Axle Left Length [mm] 200 Paired article number 16-16 020 0021   MTE0202 Required quantity 1 Thread Size 1 M10x1,25 Thread Size 2 M14x1,5 replacement in pairs recommended			
<b>References</b> Mercedes-Benz 415 460 00 05 Renault 7701478407		Mercedes-Benz A 415 460 00 05	
<b>Application info</b> Mercedes-Benz BM 415 (Citan) (11/12--) Renault Kangoo II (02/08--) Renault Latitude (07/10--) Renault Laguna III / Coupe / Grandtour (10/07-12/15)			
Tie rod end		16-16 020 0023/HD	MTE0204HD
<b>Notes</b>  Carbon Neutral Front Axle Right Length [mm] 240 Paired article number 16-16 020 0024/HD   MTE0205HD Required quantity 1 Thread Size 1 M12x1,25 Thread Size 2 M14x1,5 reinforced version replacement in pairs recommended			
<b>References</b> Renault 485200002R		Renault 485202733R	
<b>Application info</b> Renault Latitude (07/10--) Renault Laguna III / Coupe / Grandtour (10/07-12/15)			



Tie rod end		16-16 020 0024/HD	MTE0205HD
<b>Notes</b>  Carbon Neutral Front Axle Left Length [mm] 240 Paired article number 16-16 020 0023/HD   MTE0204HD Required quantity 1 Thread Size 1 M12x1,25 Thread Size 2 M14x1,5 reinforced version replacement in pairs recommended			
<b>References</b> Renault 485200001R		Renault 485201502R	
<b>Application info</b> Renault Laguna III / Coupe / Grandtour (10/07-12/15)		Renault Latitude (07/10--)	
Tie rod end		16-16 020 0025	MTE0206
<b>Notes</b>  Front Axle Left Length [mm] 209 Paired article number 16-16 020 0026   MTE0207 Required quantity 1 Thread Size 1 M10x1,25 Thread Size 2 M14x1,5 replacement in pairs recommended			
<b>References</b> Renault 485202710R		Renault 485209049R	
<b>Application info</b> Renault Fluence (02/10--) Renault Scénic III (12/08--)		Renault Megane III (11/08--)	

Tie rod end		16-16 020 0026	MTE0207
<b>Notes</b>  Front Axle Right Length [mm] 209 Paired article number 16-16 020 0025   MTE0206 Required quantity 1 Thread Size 1 M10x1,25 Thread Size 2 M14x1,5 replacement in pairs recommended			
<b>References</b> Renault 485204680R		Renault 485205192R	
<b>Application info</b> Renault Fluence (02/10--) Renault Scénic III (12/08--)		Renault Megane III (11/08--)	
Tie rod end		16-16 020 0027	MTE0208
<b>Notes</b>  Front Axle Right Length [mm] 220 Paired article number 16-16 020 0028   MTE0209 Required quantity 1 Thread Size 1 M10x1,25 Thread Size 2 M14x1,5 replacement in pairs recommended			
<b>References</b> Dacia 82 01 108 332		Renault 8201108332	
<b>Application info</b> Dacia Duster I (04/10--) Renault Kaptur (03/16--)		Renault Duster I (01/11--)	





Tie rod end		16-16 020 0028	MTE0209
<b>Notes</b>  Front Axle Left Length [mm] 220 Paired article number 16-16 020 0027   MTE0208 Required quantity 1 Thread Size 1 M10x1.25 Thread Size 2 M14x1.5 replacement in pairs recommended			
<b>References</b> Dacia 82 01 108 339 Renault 8201108339			
<b>Application info</b> Dacia Duster I (04/10--) Renault Duster I (01/11--) Renault Kaptur (03/16--)			
Tie rod end		16-16 020 0029	MTE0210
<b>Notes</b>  Front Axle Right Length [mm] 224 Paired article number 16-16 020 0030   MTE0211 Required quantity 1 Thread Size 1 M14x1,5 Thread Size 2 M18x1,5 replacement in pairs recommended			
<b>References</b> GENERAL MOTORS 93167689 Nissan 48520-00Q0E Opel 44 20 098 Renault 485200780R Vauxhall 44 20 098			
<b>Application info</b> Nissan Interstar II (X62B) (11/21--) Nissan NV400 (11/11--) Opel Movano B (05/10--) Renault Master III (02/10--) Vauxhall Movano Mk II (05/10--)			













Tie rod end		16-16 020 0030	MTE0211
<b>Notes</b>  Front Axle Left Length [mm] 224 Paired article number 16-16 020 0029   MTE0210 Required quantity 1 Thread Size 1 M14x1,5 Thread Size 2 M18x1,5 replacement in pairs recommended			
<b>References</b> GENERAL MOTORS 93167688 Nissan 48520-00Q0F Opel 44 20 097 Renault 485206730R Vauxhall 44 20 097			
<b>Application info</b> Nissan Interstar II (X62B) (11/21--) Opel Movano B (05/10--) Vauxhall Movano Mk II (05/10--) Nissan NV400 (11/11--) Renault Master III (02/10--)			
Tie rod end		16-16 020 0037/HD	MTE0805HD
<b>Notes</b>  Carbon Neutral Front Axle Left outer Length [mm] 193 Paired article number 16-16 020 0038/HD   MTE0806HD Required quantity 1 Thread Size 1 10x1,25 Thread Size 2 14x1,5 reinforced version replacement in pairs recommended			
<b>References</b> Nissan D8640-4EA0A Renault 486404EA0A			
<b>Application info</b> Nissan Qashqai II (J11_) (11/13--) Renault Kadjar (06/15--)			

Tie rod end		16-16 020 0038/HD	MTE0806HD
<b>Notes</b>	Carbon Neutral Front Axle Right outer		
Length [mm]	193		
Paired article number	16-16 020 0037/HD   MTE0805HD		
Required quantity	1		
Thread Size 1	10x1,25		
Thread Size 2	14x1,5		
reinforced version replacement in pairs recommended			
<b>References</b>	Nissan D8520-4EA0A	Renault 485204EA0A	
<b>Application info</b>	Nissan Qashqai II (J11_) (11/13--)	Renault Kadjar (06/15--)	
Tie rod end		16-16 020 0039/HD	MTE0826HD
<b>Notes</b>	Carbon Neutral Front Axle Left outer		
Length [mm]	211		
Paired article number	16-16 020 0040/HD   MTE0827HD		
Required quantity	1		
Thread Size 1	10x1x25		
Thread Size 2	14x1,5		
reinforced version replacement in pairs recommended			
<b>References</b>	Renault 485206481R		
<b>Application info</b>	Renault Espace V (02/15--) Renault Scenic / Grand Scenic IV (09/16--)	Renault Megane IV (11/15--) Renault Talisman (06/15--)	

Tie rod end		16-16 020 0040/HD	MTE0827HD
<b>Notes</b>			
	Carbon Neutral		
	Front Axle Right		
Length [mm]	211		
Paired article number	16-16 020 0039/HD   MTE0826HD		
Required quantity	1		
Thread Size 1	10x1,25		
Thread Size 2	14x1,5		
reinforced version			
replacement in pairs recommended			
<b>References</b>			
Renault 485201340R			
<b>Application info</b>			
Renault Espace V (02/15--)		Renault Megane IV (11/15--)	
Renault Scenic / Grand Scenic IV (09/16--)		Renault Talisman (06/15--)	
Tie rod end		16-16 020 0041/HD	MTE0761HD
<b>Notes</b>			
	Carbon Neutral		
	Front Axle Left		
Length [mm]	210		
Paired article number	16-16 020 0042/HD   MTE0762HD		
Required quantity	1		
Thread Size 1	M12x1,5		
Thread Size 2	M14x1,5		
reinforced version			
replacement in pairs recommended			
<b>References</b>			
Citroën 16 099 482 80		Citroën 3817.80	
Peugeot 16 09 948 280		Peugeot 3817.80	
<b>Application info</b>			
Citroën C5 III (RD_, TD_) (02/08--)		Peugeot 508 I (11/10--)	



Tie rod end		16-16 020 0042/HD	MTE0762HD
<b>Notes</b>			
	Carbon Neutral		
	Front Axle Right		
Length [mm]	210		
Paired article number	16-16 020 0041/HD   MTE0761HD		
Required quantity	1		
Thread Size 1	M12x1,5		
Thread Size 2	M14x1,5		
reinforced version			
replacement in pairs recommended			
<b>References</b>			
Citroën 16 09 948 380		Citroën 3817.81	
Peugeot 16 09 948 380		Peugeot 3817.81	
<b>Application info</b>			
Citroën C5 III (RD_, TD_) (02/08--)		Peugeot 508 I (11/10--)	
Tie rod end		16-16 020 0043/HD	MTE0817HD
<b>Notes</b>			
	Carbon Neutral		
	Front Axle Right		
Length [mm]	185		
Paired article number	16-16 020 0044/HD   MTE0818HD		
Required quantity	1		
Thread Size 1	M10x1,25		
Thread Size 2	M14x1,5		
reinforced version			
replacement in pairs recommended			
<b>References</b>			
Renault 485208355R			
<b>Application info</b>			
Renault Captur I (06/13--)		Renault Clio IV (11/12--)	
Renault Kaptur (03/16--)		Renault Zoe (06/12--)	

Tie rod end		16-16 020 0044/HD	MTE0818HD
<b>Notes</b>		  	  
	Carbon Neutral		
	Front Axle Left		
Length [mm]	185		
Paired article number	16-16 020 0043/HD   MTE0817HD		
Required quantity	1		
Thread Size 1	M10x1,25		
Thread Size 2	M14x1,5		
reinforced version			
replacement in pairs recommended			
<b>References</b>			
Renault 485200368R			
<b>Application info</b>			
Renault Captur I (06/13--)		Renault Clio IV (11/12--)	
Renault Kaptur (03/16--)		Renault Zoe (06/12--)	
Tie rod end		16-16 020 0045/HD	MTE0953HD
<b>Notes</b>		  	  
	Carbon Neutral		
	Front Axle Left		
	Lower		
	outer		
Length [mm]	179		
Paired article number	16-16 020 0046/HD   MTE0954HD		
Required quantity	1		
Thread Size 1	M10X1,25		
Thread Size 2	M14X1,5		
reinforced version			
replacement in pairs recommended			
<b>References</b>			
Renault 485205594R			
<b>Application info</b>			
Renault Arkana (08/19--)		Renault Captur II (01/20--)	
Renault Clio V (06/19--)			

## Tie rod end

16-16 020 0046/HD

MTE0954HD

## Notes

Carbon Neutral  
Front Axle Right  
Lower  
outer

Length [mm] 179  
Paired article number 16-16 020 0045/HD | MTE0953HD  
Required quantity 1  
Thread Size 1 M10X1,25  
Thread Size 2 M14X1,5  
reinforced version  
replacement in pairs recommended



## References

Renault 485208986R

## Application info

Renault Arkana (08/19--)  
Renault Clio V (06/19--)

Renault Captur II (01/20--)

## Tie rod end

16-16 020 0047/HD

MTE0970HD

## Notes

Carbon Neutral  
Front Axle Left

Length [mm] 209  
Paired article number 16-16 020 0048/HD | MTE0971HD  
Required quantity 1  
Thread Size 1 M10X1,25  
Thread Size 2 M14X1,5  
reinforced version  
replacement in pairs recommended



## References



Dacia 485209260R



Renault 485209260R

## Application info

Dacia Duster II (10/17--)  
Renault Duster II (10/17--)

Renault Arkana (08/19--)

Tie rod end		16-16 020 0048/HD	MTE0971HD
<b>Notes</b>  Carbon Neutral Front Axle Right Length [mm] 209 Paired article number 16-16 020 0047/HD   MTE0970HD Required quantity 1 Thread Size 1 M10x1,25 Thread Size 2 M14X1,5 reinforced version replacement in pairs recommended			
<b>References</b> Dacia 485207921R		Renault 485207921R	
<b>Application info</b> Dacia Duster II (10/17--) Renault Duster II (10/17--)		Renault Arkana (08/19--)	
Tie rod end		16-16 020 0049	MTE0999
<b>Notes</b>  Front Axle Left outer Length [mm] 209 Paired article number 16-16 020 0050   MTE1000 Required quantity 1 Thread Size 1 M10 x 1,25 Thread Size 2 M14 x 1,5 replacement in pairs recommended			
<b>References</b> Dacia 486401937R		Renault 486401937R	
<b>Application info</b> Dacia Jogger (03/22--) Dacia Sandero III (01/21--)		Dacia Logan III (05/21--) Renault Taliant (08/21--)	

Tie rod end		16-16 020 0050	MTE1000
<b>Notes</b>  Front Axle Right outer Length [mm] 209 Paired article number 16-16 020 0049   MTE0999 Required quantity 1 Thread Size 1 M10 x 1,25 Thread Size 2 M14 x 1,5 replacement in pairs recommended			
<b>References</b> Dacia 485204998R Renault 485204998R			
<b>Application info</b> Dacia Jogger (03/22--) Dacia Logan III (05/21--) Dacia Sandero III (01/21--) Renault Taliant (08/21--)			
Tie rod end		16-16 020 0051/HD	MTE1001HD
<b>Notes</b>  Front Axle Left Length [mm] 183 Paired article number 16-16 020 0052/HD   MTE1002HD Required quantity 1 Thread Size 1 M14x1,5 Thread Size 2 M14x1,5 reinforced version replacement in pairs recommended			
<b>References</b> Mercedes-Benz 470 460 48 00 Mercedes-Benz A 470 460 48 00 Nissan 48640-4JA0A Renault 48640-4JA0A Renault D86404JA0A			
<b>Application info</b> Mercedes-Benz BM 470 (X-Class) (09/17--) Nissan Navara (D40) (10/04--) Renault Alaskan (10/16--)			

## Tie rod end

16-16 020 0052/HD

MTE1002HD

## Notes

Front Axle Right

Length [mm]

183

Paired article number

16-16 020 0051/HD | MTE1001HD

Required quantity

1

Thread Size 1

M14x1,5

Thread Size 2

M14x1,5

reinforced version

replacement in pairs recommended



## References

Mercedes-Benz 470 460 48 00

Mercedes-Benz A 470 460 48 00

Nissan 48520-4JA0A

Renault 48520-4JA0A

## Application info

Mercedes-Benz BM 470 (X-Class) (09/17--)

Nissan Navara (D40) (10/04--)

Renault Alaskan (10/16--)

## Tie rod end

16-16 020 4273

MTE0214

## Notes

Front Axle Left

Front Axle Right

Length [mm]

96

Required quantity

2

Thread Size 1

M10x1,25

Thread Size 2

M14x1,5

replacement in pairs recommended



## References

GENERAL MOTORS 9111661

Opel 44 03 661

Renault 7701461770



Vauxhall 44 03 661



## Application info

Opel Arena (01/97-12/01)



Renault Trafic I (03/80-10/02)



Vauxhall Arena (01/97-08/01)



Tie rod end		16-16 020 7053	MTE0221
<b>Notes</b>  Front Axle Left Length [mm] 131 Manufacturer Restriction SMI / TRW Paired article number 16-16 020 7054   MTE0222 Required quantity 1 Thread Size 1 M10x1,25 Thread Size 2 M14x1,5 replacement in pairs recommended			
<b>References</b> Renault 6000022752 Renault 7700834566 Renault 7701041311 Renault 7701470765			
<b>Application info</b> Renault Kangoo I (08/97--) Renault Mégane I / Scénic I (08/95-07/10)			
Tie rod end		18-16 010 0002	MTE0225
<b>Notes</b>  Front Axle Left Front Axle Right outer Length [mm] 74 Required quantity 2 Thread Size 1 M12x1,5 Thread Size 2 M14x1,5 replacement in pairs recommended			
<b>References</b> DAIMLER JLM1098 DAIMLER JLM9660 Jaguar JLM1098 Jaguar JLM9660			
<b>Application info</b> DAIMLER XJ 40, 81 (10/86-09/94) Jaguar XJ (X300) (09/94-12/99) Jaguar XJ (X308) (09/96-06/03) Jaguar XJ (XJ40) (10/86-12/95) Jaguar XJS (09/73-09/97) Jaguar XK 8 (QDV, QEV) (03/96-12/06)			

Tie rod end		18-16 020 0000/HD	MTE0226HD
<b>Notes</b>			
	Carbon Neutral		
	Front Axle Left		
Length [mm]	188		
Paired article number	18-16 020 0001/HD   MTE0227HD		
Required quantity	1		
Thread Size 1	M12x1,75		
Thread Size 2	M14x1,75		
reinforced version			
replacement in pairs recommended			
<b>References</b>			
DAIMLER C2C20177		Jaguar C2C15228	
Jaguar C2C20177		Jaguar C2C35783	
Jaguar C2C8371		Jaguar C2D47155	
<b>Application info</b>			
DAIMLER Super eight (X350) (09/05-12/09)		Jaguar S-Type (CCX) (10/98-12/08)	
Jaguar XJ (X350) (03/03-03/09)		Jaguar XK (03/06-12/14)	
Tie rod end		18-16 020 0001/HD	MTE0227HD
<b>Notes</b>			
	Carbon Neutral		
	Front Axle Right		
Length [mm]	188		
Paired article number	18-16 020 0000/HD   MTE0226HD		
Paired article number	18-16 020 0001   MTE0227		
Required quantity	1		
Thread Size 1	M12x1,75		
Thread Size 2	M14x1,75		
reinforced version			
replacement in pairs recommended			
<b>References</b>			
DAIMLER C2C20176		Jaguar C2C15277	
Jaguar C2C20176		Jaguar C2C8370	
Jaguar C2D47153			
<b>Application info</b>			
DAIMLER Super eight (X350) (09/05-12/09)		Jaguar S-Type (CCX) (10/98-12/08)	
Jaguar XJ (X350) (03/03-03/09)		Jaguar XK (03/06-12/14)	



Tie rod end		18-16 020 0002/HD	MTE0553HD
<b>Notes</b>  Carbon Neutral Front Axle Left Length [mm] 188 Paired article number 18-16 020 0003/HD   MTE0554HD Required quantity 1 Thread Size 1 M14x2,0 Thread Size 2 M14x1,5 reinforced version replacement in pairs recommended			
<b>References</b> Jaguar C2D47154		Jaguar C2Z5518	
<b>Application info</b> Jaguar XF I (X250) (03/08--)		Jaguar XK (03/06-12/14)	
Tie rod end		18-16 020 0003/HD	MTE0554HD
<b>Notes</b>  Carbon Neutral Front Axle Right Length [mm] 188 Paired article number 18-16 020 0002/HD   MTE0553HD Required quantity 1 Thread Size 1 M14x2,0 Thread Size 2 M14x1,5 reinforced version replacement in pairs recommended			
<b>References</b> Jaguar C2D47152		Jaguar C2Z5517	
<b>Application info</b> Jaguar XF I (X250) (03/08--)		Jaguar XK (03/06-12/14)	

Tie rod end		18-16 020 0006	MTE0842
<b>Notes</b>			
	Front Axle Right		
	outer		
Length [mm]	201		
Paired article number	18-16 020 0007   MTE0843		
Required quantity	1		
Thread Size 1	M14x2,0		
Thread Size 2	M14X1,5		
replacement in pairs recommended			
<b>References</b>			
Jaguar T2H21416		Jaguar T2H6305	
<b>Application info</b>			
Jaguar XE (X760) (03/15--)		Jaguar XF II (X260) (05/15--)	
Tie rod end		18-16 020 0007	MTE0843
<b>Notes</b>			
	Front Axle Left		
	outer		
Length [mm]	201		
Paired article number	18-16 020 0006   MTE0842		
Required quantity	1		
Thread Size 1	M14x2,0		
Thread Size 2	M14x1,5		
replacement in pairs recommended			
<b>References</b>			
Jaguar T2H21417		Jaguar T2H6306	
<b>Application info</b>			
Jaguar XE (X760) (03/15--)		Jaguar XF II (X260) (05/15--)	

Tie rod end		18-16 020 0008/HD	MTE0901HD
<b>Notes</b>  Carbon Neutral Front Axle Right Length [mm] 197 Paired article number 18-16 020 0009/HD   MTE0902HD Required quantity 1 Thread Size 1 M14x2,0 Thread Size 2 M14x1,5 reinforced version replacement in pairs recommended			
<b>References</b> Jaguar C2D47158		Jaguar T2R1326	
<b>Application info</b> Jaguar F-Type (10/12--)			
Tie rod end		18-16 020 0009/HD	MTE0902HD
<b>Notes</b>  Carbon Neutral Front Axle Left Length [mm] 197 Paired article number 18-16 020 0008/HD   MTE0901HD Required quantity 1 Thread Size 1 M14x2,0 Thread Size 2 M14x1,5 reinforced version replacement in pairs recommended			
<b>References</b> Jaguar C2D47159		Jaguar T2R1328	
<b>Application info</b> Jaguar F-Type (10/12--)			

## Tie rod end

18-16 020 0010/HD

MTE0882HD

## Notes

Carbon Neutral  
Front Axle Right

Length [mm] 215  
 Paired article number 18-16 020 0011/HD | MTE0883HD  
 Required quantity 1  
 Thread Size 1 M14x2,0  
 Thread Size 2 M14x1,5  
 reinforced version  
 replacement in pairs recommended



## References

Jaguar C2D47156

Jaguar C2D7778

## Application info

Jaguar XJ (X351) (10/09--)

## Tie rod end

18-16 020 0011/HD

MTE0883HD

## Notes

Carbon Neutral  
Front Axle Left

Length [mm] 215  
 Paired article number 18-16 020 0010/HD | MTE0882HD  
 Required quantity 1  
 Thread Size 1 M14x2,0  
 Thread Size 2 M14x1,5  
 reinforced version  
 replacement in pairs recommended





## References



Jaguar C2D47157



Jaguar C2D7779



## Application info

Jaguar XJ (X351) (10/09--)

Tie rod end		216 010 0001	MTE0228
<b>Notes</b>  Front Axle Left Front Axle Right  Length [mm] 92 Required quantity 2 Thread Size 1 M10x1,25 Thread Size 2 M12x1,5 replacement in pairs recommended			
<b>References</b> Fiat 5960834 Fiat 5960835 Seat SE-141162410A			
<b>Application info</b> Fiat Panda I (03/80-07/04) Seat Marbella (08/86-05/99)			
Tie rod end		216 020 0000	MTE0229
<b>Notes</b>  Front Axle Left Front Axle Right  Length [mm] 111 Required quantity 2 Thread Size 1 M10x1,25 Thread Size 2 M14x1,5 replacement in pairs recommended			
<b>References</b> Alfa Romeo 9947720 Alfa Romeo 9950775 Fiat 9947720 Fiat 9947926 Fiat 9950775 Lancia 9947926			
<b>Application info</b> Fiat Marea / Multipla (05/96-06/10) Lancia Lybra (07/99-10/05)			

Tie rod end		216 020 0007	MTE0232
<b>Notes</b>  Front Axle Left Front Axle Right  Length [mm] 95 Required quantity 2 Thread Size 1 M10x1,25 Thread Size 2 M14x1,5 replacement in pairs recommended			
<b>References</b> Chrysler 9949218 Fiat 9949218 Lancia 9949218			
<b>Application info</b> Chrysler Delta (08/11--) Fiat Bravo (198) (11/06--) Lancia Delta III (08/08-08/14) Fiat Brava / Bravo (182) (10/95-06/03) Fiat Stilo (10/01-11/10)			
Tie rod end		216 020 0008	MTE0233
<b>Notes</b>  Front Axle Right  Length [mm] 145 Paired article number 216 020 0009   MTE0234 Required quantity 1 Thread Size 1 M10x1,25 Thread Size 2 M14x1,5 replacement in pairs recommended			
<b>References</b> Fiat 46456660 Fiat 46745364 Fiat 98845031			
<b>Application info</b> Fiat Doblo (119, 223) (11/00--) Fiat Palio / Albea / Siena / Strada (04/96--)			

Tie rod end		216 020 0009	MTE0234
<b>Notes</b>  Front Axle Left Length [mm] 145 Paired article number 216 020 0008   MTE0233 Required quantity 1 Thread Size 1 M10x1,25 Thread Size 2 M14x1,5 replacement in pairs recommended			
<b>References</b> Fiat 46456189 Fiat 46745365 Fiat 98845032			
<b>Application info</b> Fiat Doblo (119, 223) (11/00--) Fiat Palio / Albea / Siena / Strada (04/96--) 			
Tie rod end		216 020 0013/HD	MTE0748HD
<b>Notes</b>  Carbon Neutral Front Axle Left Length [mm] 135 Paired article number 216 020 0014/HD   MTE0749HD Required quantity 1 Thread Size 1 10x1.5 Thread Size 2 14x1.5 reinforced version replacement in pairs recommended			
<b>References</b> Fiat 77366165			
<b>Application info</b> Fiat 500L (09/12--) 			

Tie rod end		216 020 0014/HD	MTE0749HD
<b>Notes</b>			
	Carbon Neutral		
	Front Axle Right		
Length [mm]	135		
Paired article number	216 020 0013/HD   MTE0748HD		
Required quantity	1		
Thread Size 1	10x1.5		
Thread Size 2	14x1.5		
reinforced version			
replacement in pairs recommended			
<b>References</b>			
Fiat 77366166			
<b>Application info</b>			
Fiat 500L (09/12--)			
Tie rod end		216 020 0015	MTE0237
<b>Notes</b>			
	Front Axle Left		
Length [mm]	115		
Paired article number	216 020 0016   MTE0238		
Required quantity	1		
Thread Size 1	M10x1,5		
Thread Size 2	M14x1,5		
replacement in pairs recommended			
<b>References</b>			
Alfa Romeo 77363829		Citroën 3817.86	
Fiat 51861102		Fiat 52049738	
Fiat 77363828		Fiat 77363829	
Fiat 77364568		GENERAL MOTORS 93189022	
GENERAL MOTORS 93189023		GENERAL MOTORS 93196540	
GENERAL MOTORS 93196541		Opel 16 03 543	
Opel 16 03 544		Opel 16 09 347	
Opel 16 09 456		Opel 16 09 457	
Peugeot 3817.86		Vauxhall 16 03 543	
Vauxhall 16 03 544		Vauxhall 16 09 456	
Vauxhall 16 09 457		Vauxhall 93 18 9041	



**Application info**

ABARTH Grande Punto (12/07-12/12)  
 Alfa Romeo Mito (08/08--)  
 Fiat Fiorino Nuovo (225) (01/07--)  
 Fiat Linea (10/06--)  
 Fiat Qubo (02/08--)  
 Opel Corsa D (07/06-08/14)  
 Peugeot Bipper (02/08--)  
 Vauxhall Combo Mk III (07/06--)  
 Vauxhall Corsa Mk IV (08/14--)

ABARTH Punto III (03/12--)  
 Citroën Nemo (02/08--)  
 Fiat Grande Punto (06/05--)  
 Fiat Punto Evo (07/08--)  
 Opel Adam (10/12-02/19)  
 Opel Corsa E (09/14--)  
 Vauxhall Adam (10/12-04/19)  
 Vauxhall Corsa Mk III (07/06-08/14)

**Tie rod end****216 020 0016****MTE0238****Notes**

Front Axle Right  
 Length [mm] 115  
 Paired article number 216 020 0015 | MTE0237  
 Required quantity 1  
 Thread Size 1 M10x1,25  
 Thread Size 2 M14x1,5  
 replacement in pairs recommended

**References**



Alfa Romeo 77363830  
 Fiat 77363830  
 GENERAL MOTORS 93189024  
 Opel 16 03 545  
 Opel 931 965 42  
 Vauxhall 16 03 545  
 Vauxhall 93 19 6542



Citroën 3817.87  
 Fiat 77364569  
 GENERAL MOTORS 93196542  
 Opel 16 09 458  
 Peugeot 3817.87  
 Vauxhall 16 09 458



**Application info**



ABARTH Grande Punto (12/07-12/12)  
 Alfa Romeo Mito (08/08--)  
 Fiat Fiorino Nuovo (225) (01/07--)  
 Fiat Linea (10/06--)  
 Fiat Qubo (02/08--)  
 Opel Corsa D (07/06-08/14)  
 Peugeot Bipper (02/08--)  
 Vauxhall Combo Mk III (07/06--)  
 Vauxhall Corsa Mk IV (08/14--)





ABARTH Punto III (03/12--)  
 Citroën Nemo (02/08--)  
 Fiat Grande Punto (06/05--)  
 Fiat Punto Evo (07/08--)  
 Opel Adam (10/12-02/19)  
 Opel Corsa E (09/14--)  
 Vauxhall Adam (10/12-04/19)  
 Vauxhall Corsa Mk III (07/06-08/14)





Tie rod end		216 020 0017	MTE0239
<b>Notes</b>  Front Axle Left Front Axle Right  Length [mm] 153 Required quantity 2 Thread Size 1 M10x1,25 Thread Size 2 M14x1,5 replacement in pairs recommended			
<b>References</b> Fiat 77362503 Lancia 77362503			
<b>Application info</b> Fiat Idea (12/03--) Lancia Musa (10/04-09/12)			
Tie rod end		216 020 0023	MTE0244
<b>Notes</b>  Front Axle Right  Length [mm] 110 Paired article number 216 020 0024   MTE0245 Required quantity 1 Thread Size 1 M10x1,25 Thread Size 2 M14x1,5 replacement in pairs recommended			
<b>References</b> Fiat 77365224 Opel 16 09 192 Opel 95512976 Vauxhall 95 51 2976			
<b>Application info</b> Fiat Doblo (263) (11/09--) Opel Combo D (02/12--) Vauxhall Combo Mk III (07/06--)			



Tie rod end		216 020 0024	MTE0245
<b>Notes</b>  Front Axle Left Length [mm] 110 Paired article number 216 020 0023   MTE0244 Required quantity 1 Thread Size 1 10x1,25 Thread Size 2 M14x1,5 replacement in pairs recommended			
<b>References</b> Fiat 77365223 Opel 16 09 193 Opel 95512977 Vauxhall 95 51 2977			
<b>Application info</b> Fiat Doblo (263) (11/09--) Vauxhall Combo Mk III (07/06--) Opel Combo D (02/12--)			
Tie rod end		216 020 0041/HD	MTE0764HD
<b>Notes</b>  Carbon Neutral Front Axle Left Length [mm] 135 Paired article number 216 020 0042/HD   MTE0765HD Required quantity 1 Thread Size 1 10x1,5 Thread Size 2 14x1,5 reinforced version replacement in pairs recommended			
<b>References</b> Fiat 52169263 Fiat 77366698 Jeep 77366698			
<b>Application info</b> Fiat 500X (09/14--) Jeep Renegade (BU, B1) (07/14--) Fiat 500e (332_) (10/20--)			

Tie rod end		216 020 0042/HD	MTE0765HD
<b>Notes</b>			
	Carbon Neutral		
	Front Axle Right		
Length [mm]	135		
Paired article number	216 020 0041/HD   MTE0764HD		
Required quantity	1		
Thread Size 1	10x1,5		
Thread Size 2	14x1,5		
reinforced version			
replacement in pairs recommended			
<b>References</b>			
Fiat 52169264		Fiat 77366699	
Jeep 77366699			
<b>Application info</b>			
Fiat 500X (09/14--)		Fiat 500e (332_) (10/20--)	
Jeep Renegade (BU, B1) (07/14--)			
Tie rod end		216 020 0043/HD	MTE0773HD
<b>Notes</b>			
	Carbon Neutral		
	Front Axle Left		
	Front Axle Right		
	outer		
Length [mm]	108.5		
Required quantity	2		
Thread Size 1	14x1,5		
Thread Size 2	16x1,5		
reinforced version			
replacement in pairs recommended			
<b>References</b>			
Iveco 4256 9563			
<b>Application info</b>			
Iveco Daily VI (03/14--)			



Tie rod end		216 020 0044/HD	MTE0776HD
<b>Notes</b>  Carbon Neutral Front Axle Left Front Axle Right outer  Length [mm] 87 Required quantity 2 Thread Size 1 14x1,5 Thread Size 2 16x1,5 reinforced version replacement in pairs recommended			
<b>References</b> Iveco 4256 9562			
<b>Application info</b> Iveco Daily VI (03/14-- )			
Tie rod end		216 020 0045/HD	MTE0779HD
<b>Notes</b>  Carbon Neutral Front Axle Left Front Axle Right outer  Length [mm] 100 Required quantity 2 Thread Size 1 14x1,5 Thread Size 2 16x1,5 reinforced version replacement in pairs recommended			
<b>References</b> Iveco 4256 9564			
<b>Application info</b> Iveco Daily VI (03/14-- )			



Tie rod end		216 020 0046	MTE0775
<b>Notes</b>  Front Axle Left Front Axle Right outer  Length [mm] 135 Required quantity 2 Thread Size 1 10x1,5 Thread Size 2 14x1,5 replacement in pairs recommended		 	
<b>References</b> Fiat 77367379			
<b>Application info</b> Fiat Tipo (356) (10/15--)			
Tie rod end		216 020 0047/HD	MTE0903HD
<b>Notes</b>  Carbon Neutral Front Axle Left  Length [mm] 135 Paired article number 216 020 0048/HD   MTE0904HD Required quantity 1 Thread Size 1 M10x1,5 Thread Size 2 M16x1,5 reinforced version replacement in pairs recommended		 	
<b>References</b> Alfa Romeo 77368518 Jeep 77368518 Fiat 77368518			
<b>Application info</b> Jeep Renegade (BU, B1) (07/14--)			



Tie rod end		216 020 0048/HD	MTE0904HD
<b>Notes</b>  Carbon Neutral Front Axle Right Length [mm] 135 Paired article number 216 020 0047/HD   MTE0903HD Required quantity 1 Thread Size 1 M10x1,5 Thread Size 2 M16x1,5 reinforced version replacement in pairs recommended		 	
<b>References</b> Alfa Romeo 77369143 Fiat 77369143 Jeep 77368517			
<b>Application info</b> Jeep Renegade (BU, B1) (07/14-- )			
Tie rod end		216 020 0049	MTE0909
<b>Notes</b>  Front Axle Left outer Length [mm] 135 Paired article number 216 020 0050   MTE0910 Required quantity 1 Thread Size 1 M10x1,5 Thread Size 2 M14X1,5 replacement in pairs recommended		 	
<b>References</b> Jeep 68351149AA Jeep K68351149AA			
<b>Application info</b> Jeep Compass (MP) (01/16-- )			



Tie rod end		216 020 0050	MTE0910
<b>Notes</b>  Front Axle Right outer Length [mm] 135 Paired article number 216 020 0049   MTE0909 Required quantity 1 Thread Size 1 M10x1,5 Thread Size 2 M14x1,5 replacement in pairs recommended			
<b>References</b> Jeep 68351148AA Jeep K68351148AA			
<b>Application info</b> Jeep Compass (MP) (01/16--)			
Tie rod end		216 020 0064	MTE0249
<b>Notes</b>  Front Axle Left Front Axle Right Length [mm] 150 Required quantity 2 Thread Size 1 M10x1,25 Thread Size 2 M12x1,5 replacement in pairs recommended			
<b>References</b> Chrysler 77365815 Fiat 77365815 Lancia 77365815			
<b>Application info</b> Chrysler Ypsilon (05/11--) Fiat Panda III (02/12--) Lancia Ypsilon (846) (05/11--)			



Tie rod end		216 020 4684	MTE0254
<b>Notes</b>  Front Axle Left Front Axle Right  Length [mm] 140 Required quantity 2 Thread Size 1 M10x1,25 Thread Size 2 M12x1,5 replacement in pairs recommended			
<b>References</b> Fiat 7752285 Fiat 9946949 Lancia 7752285 Lancia 9946949			
<b>Application info</b> Fiat Barchetta (03/95-05/05) Fiat Punto I (09/93-06/00) Fiat Punto II (09/99-07/12) Lancia Y (11/95-09/03)			
Tie rod end		216 060 0007	MTE0255
<b>Notes</b>  Front Axle Left Front Axle Right for vehicles with power steering  Length [mm] 120 Required quantity 2 Thread Size 1 M14x1,5 Thread Size 2 M16x1,5 replacement in pairs recommended			
<b>References</b> Citroën 4018.E0 Fiat 77362278 Peugeot 4018.E0			
<b>Application info</b> Citroën Jumper II (02/02--) Fiat Ducato (244) (04/02--) Peugeot Boxer II (12/01--)			

Tie rod end		28-16 020 0000	MTE0258
<b>Notes</b>  Front Axle Left outer Length [mm] 156 Paired article number 28-16 020 0001   MTE0259 Required quantity 1 Thread Size 1 M12x1,25 Thread Size 2 M14x1,5 replacement in pairs recommended			
<b>References</b> Kia 56820 3E000			
<b>Application info</b> Kia Sorento I (08/02-- )			
Tie rod end		28-16 020 0001	MTE0259
<b>Notes</b>  Front Axle Right outer Length [mm] 156 Paired article number 28-16 020 0000   MTE0258 Required quantity 1 Thread Size 1 M12x1,25 Thread Size 2 M14x1,5 replacement in pairs recommended			
<b>References</b> Kia 56820 3E900			
<b>Application info</b> Kia Sorento I (08/02-- )			

Tie rod end		28-16 020 0009	MTE0263
<b>Notes</b> Front Axle Left Front Axle Right outer Length [mm] 73 Required quantity 2 Thread Size 1 M10x1,25 Thread Size 2 M12x1,25 replacement in pairs recommended			
<b>References</b> Kia 56820 07000      Kia F4BZ3 A130A Kia K9921 1201      Kia MDX50 32280			
<b>Application info</b> Kia Picanto I (04/04--) Kia Rio I (07/00-04/06)			
Tie rod end		28-16 020 0010	MTE0264
<b>Notes</b> Front Axle Left Length [mm] 230 Paired article number 28-16 020 0011   MTE0265 Required quantity 1 Thread Size 1 M10x1,25 Thread Size 2 M14x1,5 replacement in pairs recommended			
<b>References</b> Hyundai 56820-2H000      Kia 56820 2H000			
<b>Application info</b> Hyundai Elantra IV (09/05--) Kia Cee'd I (12/06-02/13) Hyundai i30 I (10/07-06/12) Kia Cerato II (TD) (01/09-- )			

Tie rod end		28-16 020 0011	MTE0265
<b>Notes</b>			
	Front Axle Right		
Length [mm]	230		
Paired article number	28-16 020 0010   MTE0264		
Required quantity	1		
Thread Size 1	M10x1,25		
Thread Size 2	M14x1,5		
replacement in pairs recommended			
<b>References</b>			
Hyundai 56820-2H090		Kia 56820 2H090	
<b>Application info</b>			
Hyundai Elantra IV (09/05--)		Hyundai i30 I (10/07-06/12)	
Kia Cee'd I (12/06-02/13)		Kia Cerato II (TD) (01/09--)	
Tie rod end		28-16 020 0021/HD	MTE0850HD
<b>Notes</b>			
	Carbon Neutral		
	Front Axle Left		
	outer		
Length [mm]	202		
Paired article number	28-16 020 0022/HD   MTE0851HD		
Required quantity	1		
Thread Size 1	M10X1,25		
Thread Size 2	M16X1,5		
reinforced version			
replacement in pairs recommended			
<b>References</b>			
Hyundai 56820-0U500		Hyundai 56820-1R501	
Hyundai 56820-1W000		Kia 56820 0U500	
Kia 56820 1R501		Kia 56820 1W000	
<b>Application info</b>			
Hyundai Accent IV (08/10--)		Kia Rio III (09/10--)	

**Tie rod end** **28-16 020 0022/HD**    **MTE0851HD**

**Notes**

Carbon Neutral  
 Front Axle Right  
 outer  
 Length [mm] 202  
 Paired article number 28-16 020 0021/HD | MTE0850HD  
 Required quantity 1  
 Thread Size 1 M10X1,25  
 Thread Size 2 M16x1,5  
 replacement in pairs recommended



**References**

Hyundai 56820-0U590	Hyundai 56820-1W090
Hyundai 56821-1R591	Kia 56820 0U590
Kia 56820 1W090	Kia 56821 1R591

**Application info**

Hyundai Accent IV (08/10--)	Kia Rio III (09/10--)
-----------------------------	-----------------------

**Tie rod end** **28-16 020 0027/HD**    **MTE0884HD**

**Notes**

Carbon Neutral  
 Front Axle Left  
 Length [mm] 186  
 Paired article number  
 Required quantity 1  
 Thread Size 1 10x1,25  
 Thread Size 2 16x1,5  
 reinforced version  
 replacement in pairs recommended











**References**

Hyundai 56820-C1700	Hyundai 56820-D3000
Hyundai 56820-D3500	Hyundai 56820-D3600
Kia 56820 C1700	Kia 56820 D3000
Kia 56820 D3500	Kia 56820 D3600

**Application info**

Hyundai Sonata VII (06/14--)	Hyundai Tucson II (05/15--)
Kia Sorento III (01/15--)	Kia Sportage IV (09/15--)

Tie rod end		28-16 020 0028/HD	MTE0885HD
<b>Notes</b>			
	Carbon Neutral		
	Front Axle Right		
Length [mm]	186		
Paired article number			
Required quantity	1		
Thread Size 1	10x1,25		
Thread Size 2	16x1,5		
reinforced version			
replacement in pairs recommended			
<b>References</b>			
Hyundai 56825-C1790		Hyundai 56825-D3000	
Hyundai 56825-D3500		Hyundai 56825-D3600	
Kia 56825 C1790		Kia 56825 D3000	
Kia 56825 D3500		Kia 56825 D3600	
<b>Application info</b>			
Hyundai Sonata VII (06/14--)		Hyundai Tucson II (05/15--)	
Kia Sorento III (01/15--)		Kia Sportage IV (09/15--)	
Tie rod end		28-16 020 0029/HD	MTE0893HD
<b>Notes</b>			
	Carbon Neutral		
	Front Axle Left		
Length [mm]	120		
Paired article number	28-16 020 0030/HD   MTE0894HD		
Required quantity	1		
Thread Size 1	10x1,25		
Thread Size 2	14x1,5		
reinforced version			
replacement in pairs recommended			
<b>References</b>			
Hyundai 56820-H8000		Kia 56820 H8000	
<b>Application info</b>			
Hyundai Accent V (01/18--)		Hyundai Solaris (01/17--)	
Kia Rio IV (01/17--)		Kia Stonic (07/17--)	

Tie rod end		28-16 020 0030/HD	MTE0894HD
<b>Notes</b>			
	Carbon Neutral		
	Front Axle Right		
Length [mm]	120		
Paired article number	28-16 020 0029/HD   MTE0893HD		
Required quantity	1		
Thread Size 1	10x1,25		
Thread Size 2	14X1,5		
reinforced version			
replacement in pairs recommended			
<b>References</b>			
Hyundai 56825-H8000		Kia 56825 H8000	
<b>Application info</b>			
Hyundai Accent V (01/18--)		Hyundai Solaris (01/17--)	
Kia Rio IV (01/17--)		Kia Stonic (07/17--)	
Tie rod end		28-16 020 0031/HD	MTE0891HD
<b>Notes</b>			
	Carbon Neutral		
	Front Axle Left		
Length [mm]	173		
Paired article number	28-16 020 0032/HD   MTE0892HD		
Required quantity	1		
Thread Size 1	10x1,25		
Thread Size 2	14x1,5		
reinforced version			
replacement in pairs recommended			
<b>References</b>			
Kia 56820 G6000			
<b>Application info</b>			
Kia Picanto III (03/17--)			

**Tie rod end**

28-16 020 0032/HD

MTE0892HD

**Notes**

Carbon Neutral  
 Front Axle Right  
 Length [mm] 173  
 Paired article number 28-16 020 0031/HD | MTE0891HD  
 Required quantity 1  
 Thread Size 1 10x1,25  
 Thread Size 2 14x1,5  
 reinforced version  
 replacement in pairs recommended



**References**

Kia 56825 G6900

**Application info**

Kia Picanto III (03/17--)

**Tie rod end**

28-16 020 0033/HD

MTE0945HD

**Notes**

Carbon Neutral  
 Front Axle Left  
 Length [mm] 186  
 Paired article number 28-16 020 0034/HD | MTE0946HD  
 Required quantity 1  
 Thread Size 1 M16X1,5  
 Thread Size 2 M12X1,25  
 reinforced version  
 replacement in pairs recommended



**References**

Hyundai 56820-E6000





Kia 56820 E6000

**Application info**

Hyundai Sonata VII (06/14--)

Kia Optima IV (09/15--)



Tie rod end		28-16 020 0034/HD	MTE0946HD
<b>Notes</b>			
	Carbon Neutral		
	Front Axle Right		
Length [mm]	186		
Paired article number	28-16 020 0033/HD   MTE0945HD		
Required quantity	1		
Thread Size 1	M16X1,5		
Thread Size 2	M12X1,25		
reinforced version			
replacement in pairs recommended			
<b>References</b>			
Hyundai 56825-E6090		Kia 56825 E6090	
<b>Application info</b>			
Hyundai Sonata VII (06/14--)		Kia Optima IV (09/15--)	
Tie rod end		29-16 020 0000	MTE0268
<b>Notes</b>			
	Front Axle Left		
	Front Axle Right		
Length [mm]	72		
Required quantity	2		
Thread Size 1	M12x1,25		
Thread Size 2	M12x1,5		
replacement in pairs recommended			
<b>References</b>			
Chevrolet 521136		Chevrolet 93741077	
Daewoo 48810-A78B00		Daewoo 4881078BX0	
Daewoo 48810A78B00000		Daewoo 521136	
Daewoo 93741077		Daewoo 93741091	
<b>Application info</b>			
Chevrolet Matiz (03/05--)		Chevrolet Spark / Matiz (09/00--)	
Daewoo Matiz (08/98--)		Daewoo Tico (02/95-12/00)	

## Tie rod end

29-16 020 0001

MTE0269

## Notes

Front Axle Left  
Front Axle Right

Length [mm] 75  
Required quantity 2  
Thread Size 1 M12x1,5  
Thread Size 2 M14x1,5  
replacement in pairs recommended



## References

Chevrolet 93740710  
Daewoo 520262  
Daewoo 96129753  
Daewoo 96446586

Chevrolet 96446586  
Daewoo 93740710  
Daewoo 96205809

## Application info

Chevrolet Epica (01/05--)  
Daewoo Evanda / Magnus (08/02--)  
Daewoo Nubira (KLAJ) (04/97--)

Chevrolet Evanda (03/05--)  
Daewoo Leganza (03/97-04/04)

## Tie rod end

29-16 020 0010/HD

MTE0833HD

## Notes

Carbon Neutral  
Front Axle Left  
Front Axle Right

Length [mm] 73  
Required quantity 2  
Thread Size 1 M12x1,25  
Thread Size 2 M12x1,25  
reinforced version  
replacement in pairs recommended



## References

Chevrolet 95967285

## Application info

Chevrolet Spark (M300) (12/09--)

## Tie rod end

29-16 020 0012

MTE0766

## Notes

Front Axle Left  
Front Axle Right

Length [mm] 73  
Required quantity 2  
Thread Size 1 12x1,75  
Thread Size 2 14x1,5  
replacement in pairs recommended



## References

CHEVROLET (SGM) 95218373  
Chevrolet 95218393

Chevrolet 95218373

## Application info

Chevrolet Aveo II (03/11--)

## Tie rod end

30-16 020 0004

MTE0275

## Notes

Front Axle Left  
Front Axle Right  
outer  
with left-hand thread

Length [mm] 95  
Required quantity 2  
Thread Size 1 M14x1,5  
Thread Size 2 M17x1,5  
replacement in pairs recommended



## References

Toyota 45046-29115  
Toyota 45046-39105  
Toyota 45046-39125  
Toyota 45046-39165  
Toyota 45046-39215  
Toyota 45046-39355  
Toyota 45046-39385

Toyota 45046-29125  
Toyota 45046-39106  
Toyota 45046-39135  
Toyota 45046-39175  
Toyota 45046-39235  
Toyota 45046-39375  
Volkswagen J45 046 393 75

**Application info**

Toyota 4 Runner II (08/87-12/96)

Toyota Hilux (YN58, YN80, RZN) (11/82-03/06)

Volkswagen Taro (04/89-03/97)

Toyota Hiace II (11/82-11/89)

Toyota Hilux V Pick-up (LN\_, KZN1\_, VZN1\_) (09/88-01/99)

**Tie rod end****30-16 020 0006****MTE0276****Notes**

Front Axle Left

Length [mm]

170

Paired article number

30-16 020 0018 | MTE0283

Required quantity

1

Thread Size 1

M12x1,25

Thread Size 2

M14x1,5

replacement in pairs recommended

**References**

Daihatsu 45047-09220

Toyota 45047-09150

Toyota 45047-09230

Toyota 45047-19115

Toyota 45047-59135

Toyota 45047-09050

Toyota 45047-09220

Toyota 45047-09360

Toyota 45047-49045

Toyota 45047-59165

**Application info**

Daihatsu Charade V (05/11--)

Toyota Yaris II (01/05-12/14)

Toyota Corolla (E12) (08/00-12/08)

Toyota Yaris III (12/10--)

**Tie rod end****30-16 020 0018****MTE0283****Notes**

Front Axle Right

Length [mm]

170

Paired article number

30-16 020 0006 | MTE0276

Required quantity

1

Thread Size 1

M12x1,25

Thread Size 2

M14x1,5

replacement in pairs recommended



**References**

Daihatsu 45046-09480  
 Toyota 45046-09360  
 Toyota 45046-09490  
 Toyota 45046-19265  
 Toyota 45046-59195

Toyota 45046-09160  
 Toyota 45046-09480  
 Toyota 45046-0D40  
 Toyota 45046-49115  
 Toyota 45046-59255

**Application info**

Daihatsu Charade V (05/11--)  
 Toyota Yaris II (01/05-12/14)

Toyota Corolla (E12) (08/00-12/08)  
 Toyota Yaris III (12/10--)

**Tie rod end****30-16 020 0039****MTE0290****Notes**

Front Axle Left  
 Front Axle Right

Length [mm] 84  
 Required quantity 2  
 Thread Size 1 M14x1,5  
 Thread Size 2 M15x1,5  
 replacement in pairs recommended

**References**

Toyota 45046-09280  
 Toyota 45046-09310

Toyota 45046-09281

**Application info**

Toyota Hilux (KUN) (08/04--)

**Tie rod end****30-16 020 0085/HD****MTE0929HD****Notes**

Carbon Neutral  
 Front Axle Left  
 Front Axle Right

Length [mm] 83  
 Required quantity 2  
 Thread Size 1 M14X1,5  
 Thread Size 2 M16X1,5  
 reinforced version  
 replacement in pairs recommended

**References**

Toyota 45046-09800

**Application info**

Toyota Hilux (Gun1, Gun13) (05/15--)

**Tie rod end**

30-16 020 0117

MTE0299

**Notes**

Front Axle Left

Length [mm]

145

Paired article number

30-16 020 0140 | MTE0308

Required quantity

1

Thread Size 1

M12x1,25

Thread Size 2

M16x1,5

replacement in pairs recommended

**References**

Toyota 45046-49125

**Application info**

Toyota Avensis Verso (05/01-12/11)

**Tie rod end**

30-16 020 0140

MTE0308

**Notes**

Front Axle Right

Length [mm]

145

Paired article number

30-16 020 0117 | MTE0299

Required quantity

1

Thread Size 1

M12x1,25

Thread Size 2

M16x1,5



replacement in pairs recommended



**References**

Toyota 45047-49055



**Application info**





Toyota Avensis Verso (05/01-12/11)





Tie rod end		30-16 020 0159	MTE0784
<b>Notes</b>  Front Axle Left outer Length [mm] 163 Paired article number 30-16 020 0160   MTE0785 Required quantity 1 Thread Size 1 12x1,25 Thread Size 2 15x1,5 replacement in pairs recommended			
<b>References</b> Subaru 4504759145 Toyota 45047-02030 Toyota 45047-59145			
<b>Application info</b> Subaru Trezia (11/10--) Toyota Verso S (NCP12, NSP12) (11/10-10/16) Toyota Yaris III (12/10--)			
Tie rod end		30-16 020 0160	MTE0785
<b>Notes</b>  Front Axle Right outer Length [mm] 163 Paired article number 30-16 020 0159   MTE0784 Required quantity 1 Thread Size 1 12x1,25 Thread Size 2 15x1,5 replacement in pairs recommended			
<b>References</b> Subaru 4504659205 Toyota 45046-02070 Toyota 45046-59205			
<b>Application info</b> Subaru Trezia (11/10--) Toyota Verso S (NCP12, NSP12) (11/10-10/16) Toyota Yaris III (12/10--)			





Tie rod end		30-16 020 0161/HD	MTE0819HD
<b>Notes</b>			
	Carbon Neutral		
	Front Axle Left		
Length [mm]	186		
Paired article number	30-16 020 0162/HD   MTE0820HD		
Required quantity	1		
Thread Size 1	M12x1,25		
Thread Size 2	M15x1,5		
reinforced version			
replacement in pairs recommended			
<b>References</b>			
Toyota 45047-02050		Toyota 45047-09270	
Toyota 45047-19205		Toyota 45047-19215	
<b>Application info</b>			
Toyota Auris I (10/06-09/12)		Toyota Auris II (10/12-12/18)	
Toyota Corolla (E14, E15) (10/06--)		Toyota Corolla (E170) (06/13-08/19)	
Toyota Prius Plus (ZVW4) (05/11--)			
Tie rod end		30-16 020 0162/HD	MTE0820HD
<b>Notes</b>			
	Carbon Neutral		
	Front Axle Right		
Length [mm]	186		
Paired article number	30-16 020 0161/HD   MTE0819HD		
Required quantity	1		
Thread Size 1	M12x1,25		
Thread Size 2	M15x1,5		
reinforced version			
replacement in pairs recommended			
<b>References</b>			
Toyota 45046-02080		Toyota 45046-09570	
Toyota 45046-19405		Toyota 45046-19415	
<b>Application info</b>			
Toyota Auris I (10/06-09/12)		Toyota Auris II (10/12-12/18)	
Toyota Corolla (E14, E15) (10/06--)		Toyota Corolla (E170) (06/13-08/19)	
Toyota Prius Plus (ZVW4) (05/11--)			







Tie rod end		30-16 020 0163/HD	MTE0821HD
<b>Notes</b>  Carbon Neutral Front Axle Left Length [mm] 180 Paired article number 30-16 020 0164/HD   MTE0822HD Required quantity 1 Thread Size 1 M12x1,25 Thread Size 2 M16x1,5 reinforced version replacement in pairs recommended			
<b>References</b> Toyota 45047-05060		Toyota 45047-09320	
<b>Application info</b> Toyota Avensis (T27) (11/08-10/18)		Toyota Verso (AUR2, ZGR2) (04/09-08/18)	
Tie rod end		30-16 020 0164/HD	MTE0822HD
<b>Notes</b>  Carbon Neutral Front Axle Right Length [mm] 180 Paired article number 30-16 020 0163/HD   MTE0821HD Required quantity 1 Thread Size 1 M12x1,25 Thread Size 2 M16x1,5 reinforced version replacement in pairs recommended			
<b>References</b> Toyota 45046-05070		Toyota 45046-09660	
<b>Application info</b> Toyota Avensis (T27) (11/08-10/18)		Toyota Verso (AUR2, ZGR2) (04/09-08/18)	

Tie rod end		30-16 020 0168/HD	MTE0930HD
<b>Notes</b>			
	Carbon Neutral		
	Front Axle Left		
Length [mm]	165		
Observe service information			
Paired article number	30-16 020 0169/HD   MTE0931HD		
Required quantity	1		
Thread Size 1	12X1,25		
Thread Size 2	16X1,5		
replacement in pairs recommended			
<b>References</b>			
Suzuki T45047F901		Toyota 45047-F4010	
Toyota 45047-F9010			
<b>Application info</b>			
Suzuki Swace (AMZ_) (10/20--)		Toyota CH-R I (10/16--)	
Toyota Corolla (_E21_) (10/18--)			
Tie rod end		30-16 020 0169/HD	MTE0931HD
<b>Notes</b>			
	Carbon Neutral		
	Front Axle Right		
Length [mm]	165		
Paired article number	30-16 020 0168/HD   MTE0930HD		
Required quantity	1		
Thread Size 1	12X1,25		
Thread Size 2	16X1,5		
reinforced version			
replacement in pairs recommended			
<b>References</b>			
Suzuki 45046-F4010		Suzuki T4504-6F901	
Toyota 45046-F4010		Toyota 45046-F9010	
<b>Application info</b>			
Suzuki Swace (AMZ_) (10/20--)		Toyota CH-R I (10/16--)	
Toyota Corolla (_E21_) (10/18--)			

Tie rod end		30-16 020 0170/HD	MTE0899HD
<b>Notes</b>			
	Carbon Neutral		
	Front Axle Right		
Length [mm]	165		
Paired article number	30-16 020 0171/HD   MTE0900HD		
Required quantity	1		
Thread Size 1	12x1,25		
Thread Size 2	16x1,5		
reinforced version			
replacement in pairs recommended			
<b>References</b>			
Lexus 45046-49255		Toyota 45046-49255	
<b>Application info</b>			
Lexus UX (_AA1_, _AH1_) (10/18--)		Toyota Prius IV (09/15--)	
Toyota Yaris IV (02/20--)			
Tie rod end		30-16 020 0171/HD	MTE0900HD
<b>Notes</b>			
	Carbon Neutral		
	Front Axle Left		
Length [mm]	165		
Paired article number	30-16 020 0170/HD   MTE0899HD		
Required quantity	1		
Thread Size 1	12x1,25		
Thread Size 2	16x1,5		
reinforced version			
replacement in pairs recommended			
<b>References</b>			
Lexus 45047-49195		Toyota 45047-49195	
<b>Application info</b>			
Lexus UX (_AA1_, _AH1_) (10/18--)		Toyota Prius IV (09/15--)	

Tie rod end		30-16 020 0172	MTE0966
<b>Notes</b>  Front Axle Left outer Length [mm] 186 Paired article number 30-16 020 0173   MTE0967 Required quantity 1 Thread Size 1 M12X1,25 Thread Size 2 M14X1,5 replacement in pairs recommended		 	
<b>References</b> Lexus 45047-49165		Toyota 45047-49165	
<b>Application info</b> Lexus CT (ZWA1) (12/10--)		Toyota Prius III (06/08--)	
Tie rod end		30-16 020 0173	MTE0967
<b>Notes</b>  Front Axle Right outer Length [mm] 186 Paired article number 30-16 020 0172   MTE0966 Required quantity 1 Thread Size 1 M12X1,25 Thread Size 2 M14X1,5 replacement in pairs recommended		 	
<b>References</b> Lexus 45046-49225		Toyota 45046-49225	
<b>Application info</b> Lexus CT (ZWA1) (12/10--)		Toyota Prius III (06/08--)	

Tie rod end		30-16 020 0174/HD	MTE1003HD
<b>Notes</b>  Front Axle Right outer Length [mm] 165 Paired article number 30-16 020 0175/HD   MTE1004HD Required quantity 1 Thread Size 1 M12 x 1,25 Thread Size 2 M16 x 1,5 reinforced version replacement in pairs recommended		 	
<b>References</b> Toyota 45046-09A20		Toyota 45046-0D190	
<b>Application info</b> Toyota Yaris IV (02/20--)			
Tie rod end		30-16 020 0175/HD	MTE1004HD
<b>Notes</b>  Front Axle Left outer Length [mm] 165 Paired article number 30-16 020 0174/HD   MTE1003HD Required quantity 1 Thread Size 1 M12 x 1,25 Thread Size 2 M16 x 1,5 reinforced version replacement in pairs recommended		 	
<b>References</b> Toyota 45047-09450		Toyota 45047-0D150	
<b>Application info</b> Toyota Yaris IV (02/20--)			

## Tie rod end

31-16 020 0007

MTE0314

## Notes

Front Axle Left

Length [mm]

217

Paired article number

31-16 020 0010 | MTE0315

Required quantity

1

Thread Size 1

M10x1,25

Thread Size 2

M14x1,5

replacement in pairs recommended



## References

Honda 53560-SM4-003

Honda 53560-SM4-004

Honda 53560-SM4-J62

Honda 53560-SN4-004

Honda 53560-SV4-003

Honda 53560-SV4-013

Honda 53560-SX0-003

Honda 53560-SX0-013

Rover GSJ407

## Application info

Honda Accord IV (05/89-02/94)

Honda Accord V / VI (06/92-12/98)

Honda Accord VII (03/97-09/05)

Honda Shuttle I (06/94-06/04)

Rover 600 (RH) (08/93-10/00)

## Tie rod end

31-16 020 0010

MTE0315

## Notes

Front Axle Right

Length [mm]

217

Paired article number

31-16 020 0007 | MTE0314

Required quantity

1

Thread Size 1

M10x1,25

Thread Size 2

M14x1,5

replacement in pairs recommended



## References

Honda 53540-S84-A01

Honda 53540-SM4-003

Honda 53540-SM4-004

Honda 53540-SM4-J62

Honda 53540-SV4-003

Honda 53540-SV4-013

Honda 53540-SV7-003

Honda 53540-SX0-003

Honda 53540-SX0-013

Rover GSJ408

**Application info**

Honda Accord IV (05/89-02/94)

Honda Accord VII (03/97-09/05)

Rover 600 (RH) (08/93-10/00)

Honda Accord V / VI (06/92-12/98)

Honda Shuttle I (06/94-06/04)

**Tie rod end****31-16 020 0045/HD****MTE0811HD****Notes**

Carbon Neutral

Front Axle Left

outer

Length [mm]

210

Paired article number

31-16 020 0046/HD | MTE0812HD

Required quantity

1

Thread Size 1

12x1,25

Thread Size 2

14x1,5

replacement in pairs recommended

**References**

Honda 53560-TV0-G01

Honda 53560-TV0-G02

**Application info**

Honda Civic IX (09/11--)

**Tie rod end****31-16 020 0046/HD****MTE0812HD****Notes**

Carbon Neutral

Front Axle Right

outer

Length [mm]

210

Paired article number

31-16 020 0045/HD | MTE0811HD

Required quantity

1

Thread Size 1

12x1,25

Thread Size 2

14x1,5

replacement in pairs recommended

**References**

Honda 53540-TV0-G01

Honda 53540-TV0-G02

**Application info**

Honda Civic IX (09/11--)

## Tie rod end

31-16 020 0047/HD

MTE0807HD

## Notes

Carbon Neutral  
Front Axle Left  
outer

Length [mm] 151  
Paired article number 31-16 020 0048/HD | MTE0808HD  
Required quantity 1  
Thread Size 1 12x1,25  
Thread Size 2 14x1,5  
reinforced version  
replacement in pairs recommended



## References

Honda 53560-T0A-A11  
Honda 53560-T1G-E01

Honda 53560-T0A-A12  
Honda 53560-T1W-A01

## Application info

Honda CR-V IV (01/12--)

## Tie rod end

31-16 020 0048/HD

MTE0808HD

## Notes

Carbon Neutral  
Front Axle Right  
outer

Length [mm] 151  
Paired article number 31-16 020 0047/HD | MTE0807HD  
Required quantity 1  
Thread Size 1 12x1,25  
Thread Size 2 14x1,5  
reinforced version  
replacement in pairs recommended



## References

Honda 53540-T0A-A11  
Honda 53540-T1G-E01

Honda 53540-T0A-A12  
Honda 53540-T1W-A01

## Application info

Honda CR-V IV (01/12--)



## Tie rod end

31-16 020 0051/HD

MTE0856HD

## Notes

Carbon Neutral

Front Axle Left

Length [mm]

165

Observe service information

Paired article number

31-16 020 0052/HD | MTE0857HD

Required quantity

1

Thread Size 1

M12x1,25

Thread Size 2

M14x1,5

replacement in pairs recommended



## References

Honda 53560-T7J-003

## Application info

Honda HR-V II (11/14--)

## Tie rod end

31-16 020 0052/HD

MTE0857HD

## Notes

Carbon Neutral

Front Axle Right

Length [mm]

165

Observe service information

Paired article number

31-16 020 0051/HD | MTE0856HD

Required quantity

1

Thread Size 1

M12x1,25

Thread Size 2

M14x1,5

replacement in pairs recommended









## References

Honda 53540-T7J-003

## Application info

Honda HR-V II (11/14--)

Tie rod end		31-16 020 0054/HD	MTE0823HD
<b>Notes</b>  Carbon Neutral Front Axle Right Length [mm] 195 Paired article number 31-16 020 0055/HD   MTE0824HD Required quantity 1 Thread Size 1 M12x1,25 Thread Size 2 M14x1,5 reinforced version replacement in pairs recommended			
<b>References</b> Honda 53540-SMG-003		Honda 53540-SMJ-003	
<b>Application info</b> Honda Civic VIII (09/05--)			
Tie rod end		31-16 020 0055/HD	MTE0824HD
<b>Notes</b>  Carbon Neutral Front Axle Left Length [mm] 195 Paired article number 31-16 020 0054/HD   MTE0823HD Required quantity 1 Thread Size 1 M12x1,25 Thread Size 2 M14x1,5 reinforced version replacement in pairs recommended			
<b>References</b> Honda 53560-SMG-003		Honda 53560-SMJ-003	
<b>Application info</b> Honda Civic VIII (09/05--)			

Tie rod end		31-16 020 0056/HD	MTE0858HD
<b>Notes</b>  Carbon Neutral Front Axle Right Length [mm] 169 Paired article number 31-16 020 0057/HD   MTE0859HD Required quantity 1 Thread Size 1 M10x1,25 Thread Size 2 M14x1,5 reinforced version replacement in pairs recommended		 	
<b>References</b> Honda 53540-T5A-003			
<b>Application info</b> Honda Jazz IV (09/13--)			
Tie rod end		31-16 020 0057/HD	MTE0859HD
<b>Notes</b>  Carbon Neutral Front Axle Left Length [mm] 169 Observe service information Paired article number 31-16 020 0056/HD   MTE0858HD Required quantity 1 Thread Size 1 M10x1,25 Thread Size 2 M14x1,5 replacement in pairs recommended		 	
<b>References</b> Honda 53560-T5A-003			
<b>Application info</b> Honda Jazz IV (09/13--)			

## Tie rod end

31-16 020 0058/HD

MTE0915HD

## Notes

Carbon Neutral  
 Front Axle Right  
 Length [mm] 209  
 Paired article number 31-16 020 0059/HD | MTE0916HD  
 Required quantity 1  
 Thread Size 1 12x1,25  
 Thread Size 2 14x1,5  
 reinforced version  
 replacement in pairs recommended



## References

Honda 53540-TBA-A01

## Application info

Honda Civic X (09/15--)

## Tie rod end

31-16 020 0059/HD

MTE0916HD

## Notes

Carbon Neutral  
 Front Axle Left  
 Length [mm] 209  
 Paired article number 31-16 020 0058/HD | MTE0915HD  
 Required quantity 1  
 Thread Size 1 12x1,25  
 Thread Size 2 14x1,5  
 reinforced version  
 replacement in pairs recommended







## References

Honda 53560-TBA-A01

## Application info

Honda Civic X (09/15--)

Tie rod end		31-16 020 0060/HD	MTE0927HD		
<b>Notes</b>					
	Carbon Neutral				
	Front Axle Right				
Length [mm]	164				
Observe service information					
Paired article number	31-16 020 0061/HD   MTE0928HD				
Required quantity	1				
Thread Size 1	12x1,25				
Thread Size 2	14x1,5				
replacement in pairs recommended					
<b>References</b>					
Honda 53540-TLA-A51					
<b>Application info</b>					
Honda CR-V V (12/16--)					
Tie rod end		31-16 020 0061/HD	MTE0928HD		
<b>Notes</b>					
	Carbon Neutral				
	Front Axle Left				
Length [mm]	164				
Observe service information					
Paired article number	31-16 020 0060/HD   MTE0927HD				
Required quantity	1				
Thread Size 1	12x1,25				
Thread Size 2	14x1,5				
replacement in pairs recommended					
<b>References</b>					
Honda 53560-TLA-A01				Honda 53560-TLA-A51	
<b>Application info</b>					
Honda CR-V V (12/16--)					

## Suspension

## Axle support bushing

16-14 710 0003

MAB0199

## Notes

Rear Axle Left  
Rear Axle Right

Height [mm] 89  
Inner Diameter [mm] 12  
Outer Diameter [mm] 69  
Required quantity 2  
replacement in pairs recommended



## References

Renault 480800003R  
Renault 550454053R

Renault 550445344R  
Renault 8200589986

## Application info

Renault Megane III (11/08--)

Renault Scénic III (12/08--)

## Axle support bushing

214 710 0003

MAB0198

## Notes

Rear Axle Left  
Rear Axle Right

Height [mm] 52  
Inner Diameter [mm] 12  
Outer Diameter [mm] 54  
Required quantity 2  
replacement in pairs recommended



## References

ABARTH 50703271  
Fiat 50703271  
Ford 1 619 916

ABARTH 51796664  
Fiat 51796664  
Ford 9S51-5K653-AA

## Application info

ABARTH 500 (01/08--)  
Fiat 500L (09/12--)  
Ford KA II (10/08-05/16)

Fiat 500 (07/07--)  
Fiat 500X (09/14--)

**Axle support bushing**

214 710 0009/HD

MAB0217HD

**Notes**

Carbon Neutral  
Rear Axle Left  
Rear Axle Right  
Rubber/Metal

Height [mm] 100  
Inner Diameter [mm] 12  
Outer Diameter [mm] 68  
Replace in pairs only  
Required quantity 2  
reinforced version



**References**

Fiat 51725622	Fiat 51808684
Fiat 52019133	Fiat 52044307
Fiat 52051193	Fiat 52094869
Jeep 68198289AA	Jeep 68201314AA
Jeep 68333284AA	Jeep 68417207AA
Jeep K68198289AA	Jeep K68201314AA
Jeep K68333284AA	Jeep K68417207AA

**Application info**

Fiat 500L (09/12--)	Fiat Linea (10/06--)
Fiat Tipo (356) (10/15--)	

**Axle support bushing**

31-14 710 0001

MAB0202

**Notes**

Plastic  
Rear Axle

Height [mm] 87  
Inner Diameter [mm] 14  
Outer Diameter [mm] 72  
Required quantity 2  
replacement in pairs recommended



**References**

Honda 42100-SMG-E04	Honda 42100-SMG-E05
Honda 42100-SMG-E06	Honda 42100-TF0-G04
Honda 42100-TF0-G05	Honda 42100-TM0-T12
Honda 42100-TM8-G02	Honda 42100-TM8-G03
Honda ZTT-HD-034B	

**Application info**

Honda Civic VIII (09/05--)	Honda Insight II (04/09--)
Honda Jazz III (10/07--)	

**Axle support bushing**

**314 710 0016 MAB0214**

**Notes**

Rear  
Rear Axle Left  
Rear Axle Right

Height [mm]	84
Inner Diameter [mm]	18.5
Outer Diameter [mm]	80.5
Paired article number	314 710 0015
Required quantity	2
replacement in pairs recommended	



**References**

BMW 33 30 6 786 972	BMW 6 786 972
---------------------	---------------

**Application info**

BMW X3 (F25) (09/10-08/17)	BMW X4 (F26) (05/13-03/18)
----------------------------	----------------------------

**Axle support bushing**

**314 710 0027 MAB0205**

**Notes**

Front  
Rear Axle

Height [mm]	54
Inner Diameter [mm]	12
Outer Diameter [mm]	50
Required quantity	2
replacement in pairs recommended	



**References**

BMW 33 31 6 792 513	BMW 6 792 513
BMW (Brilliance) 33 31 6 792 513	BMW (Brilliance) 6 792 513



**Application info**

BMW 1 (F20, F21) (07/11--)

BMW 3 (F30, F31) (11/11-06/19)

BMW 4 (F32, F33, F36) (07/13--)

BMW 2 (F22,F23) (10/12--)

BMW 3 (F34) (07/12--)

**Ball joint**

16-16 010 0001

MBJ0103

**Notes**

Front Axle Left  
 Front Axle Right  
 Lower  
 for control arm

Height [mm]

48

Outer Diameter [mm]

38.25

Required quantity

2

Thread Size

M12x1,25

replacement in pairs recommended



**References**

Renault 7700413493

Renault 7700418693

Renault 7700807194

Renault 7700807581

Renault 7700823098

Renault 7700823581

Renault 7700413494

Renault 7700421804

Renault 7700807580

Renault 7700823097

Renault 7700823580

Renault 7700829322

**Application info**

Renault Laguna I (11/93-08/02)

Renault Safrane (04/92-12/00)

**Ball joint**

16-16 010 0002

MBJ0443

**Notes**

Front Axle Left  
 Front Axle Right

Required quantity

2

Thread Size

M12x1,25

replacement in pairs recommended



**References**

Renault 54 50 485 06 R  
 Renault 545044506R  
 Renault 545050794R

Renault 54 50 505 10 R  
 Renault 545049968R  
 Renault 545058191R

**Application info**

Renault Clio IV (11/12--)

**Ball joint****16-16 010 0004/S****MBJ0426****Notes**

Front Axle Left  
 Front Axle Right  
 Lower  
 outer  
 with attachment material

Cone Size [mm] 18  
 Outer Diameter [mm] 38  
 Required quantity 2  
 replacement in pairs recommended

**References**

Dacia 401604793R  
 Dacia 545019294R  
 Dacia 6001547520  
 Dacia 6001549182  
 Dacia 6001550912  
 Dacia 8200749461  
 Dacia 8200792640  
 Dacia 8200910717  
 Renault 401604793R  
 Renault 545004269R  
 Renault 545019294R  
 Renault 6001549182  
 Renault 8200216377  
 Renault 8200298455  
 Renault 8200346942  
 Renault 8200457209  
 Renault 8200615058  
 Renault 8200679067  
 Renault 8200910716

Dacia 545000794R  
 Dacia 6001547519  
 Dacia 6001549181  
 Dacia 6001550911  
 Dacia 8200749459  
 Dacia 8200792639  
 Dacia 8200910716  
 Lada 401604793R  
 Renault 545000794R  
 Renault 545011362R  
 Renault 6001549181  
 Renault 8200216376  
 Renault 8200298454  
 Renault 8200346941  
 Renault 8200457208  
 Renault 8200615057  
 Renault 8200679063  
 Renault 8200744092  
 Renault 8200910717

**Application info**

Dacia Dokker (11/12--)  
 Dacia Logan I (08/04--)  
 Dacia Sandero I (06/08--)  
 Lada Largus (03/12--)  
 Renault Dokker (12/13--)  
 Renault Logan I (09/04--)  
 Renault Megane III (11/08--)  
 Renault Sandero/Stepway II (11/13--)  
 Renault Thalia III (12/13--)

Dacia Lodgy (03/12--)  
 Dacia Logan II (10/12--)  
 Dacia Sandero II (10/12--)  
 Renault Clio III / Modus (09/04--)  
 Renault Lodgy (JS\_) (07/13--)  
 Renault Logan II (09/12--)  
 Renault Sandero/Stepway I (11/07--)  
 Renault Scénic II (06/03-07/10)  
 Renault Twizy (04/12--)

**Ball joint****16-16 010 0005/HD****MBJ0105HD****Notes**

Carbon Neutral  
 Front Axle Left  
 Front Axle Right  
 Lower  
 for control arm  
 with accessories  
 Cone Size [mm] 19.5  
 Flange Hole Diameter [mm] 10  
 Required quantity 2  
 Thread Size M16x1,5

reinforced version  
 replacement in pairs recommended

**References**

GENERAL MOTORS 93196923  
 Nissan 54502-00Q0B  
 Nissan 54503-00Q0A  
 Nissan 54503-00QAA  
 Renault 401606676R  
 Renault 7701476576  
 Vauxhall 44 19 075

Nissan 54502-00Q0A  
 Nissan 54502-00QAA  
 Nissan 54503-00Q0B  
 Opel 44 19 075  
 Renault 6040002105  
 Renault 7701478029

**Application info**

Nissan Primastar I (X83) (03/01--)  
 Renault Espace IV (11/02--)  
 Renault Trafic II (03/01--)  
 Vauxhall Vivaro A (08/01-07/14)

Opel Vivaro A (08/01--)  
 Renault Laguna II (03/01-12/07)  
 Renault Vel Satis (06/02--)

<b>Ball joint</b>	<b>16-16 010 0006</b>	<b>MBJ0106</b>
-------------------	-----------------------	----------------

<p><b>Notes</b></p> <p>Front Axle Left Front Axle Right Lower for control arm</p> <p>Cone Size [mm] 16 Outer Diameter [mm] 38.2 Required quantity 2 replacement in pairs recommended</p>	 <p>MEYLE ORIGINAL QUALITY</p>
--	---

<b>References</b>	
Renault 8200041279	Renault 8200041282
Renault 8200255760	Renault 8200255761
Renault 8200739482	Renault 8200739484

<b>Application info</b>
Renault Mégane II (07/01--)

<b>Ball joint</b>	<b>16-16 010 0007</b>	<b>MBJ0107</b>
-------------------	-----------------------	----------------

<p><b>Notes</b></p> <p>Front Axle Left Front Axle Right</p> <p>Flange Hole Diameter [mm] 12 Required quantity 2 replacement in pairs recommended</p>	 <p>MEYLE ORIGINAL QUALITY</p>
--	---

**References**

Renault 6020010350	Renault 6020010351
Renault 6040002292	Renault 7700314678
Renault 7700314679	Renault 7700430765
Renault 7700430766	Renault 7700430832
Renault 7700781036	Renault 7700781037
Renault 7700818054	Renault 7700829842
Renault 7701474869	Renault 7701474870
Renault 8200123885	Renault 8200123886
Renault 8200123887	Renault 8200123888
Renault 8200254108	Renault 8200254109
Renault 8200254163	Renault 8200254166
Renault 8200737112	Renault 8200737114
Renault 8200737123	Renault 8200737129
Renault 8200737132	Renault 8200737133
Renault 8200739491	Renault 8200739492
Renault 8200739494	Renault 8200739495
Renault 8200942407	Renault 8200942408
Renault 8200942413	Renault 8200942417
Renault 8200942420	Renault 8200942422

**Application info**

Renault Clio II / Thalia (02/98--)

Renault Mégane I / Scénic I (08/95-07/10)

Renault Kangoo I (08/97--)

**Ball joint****16-16 010 0009****MBJ0109****Notes**

Front Axle Left  
 Front Axle Right  
 Lower  
 for control arm

Cone Size [mm] 22  
 Outer Diameter [mm] 43  
 Required quantity 2  
 replacement in pairs recommended

**References**

GENERAL MOTORS 9109909	GENERAL MOTORS 9160555
Nissan 40160-000AC	Nissan 40160-000AD
Nissan 40160-00QAC	Nissan 40160-00QAD
Opel 44 01 909	Opel 45 00 255
Renault 7700312852	Renault 7701056969
Vauxhall 44 01 909	Vauxhall 45 00 255

**Application info**

Nissan Interstar I (X70) (04/02--)  
Renault Master II (03/98--)

Opel Movano A (07/98--)  
Vauxhall Movano Mk I (10/98-12/10)

**Ball joint****16-16 010 0010****MBJ0110****Notes**

Front Axle Left  
Front Axle Right  
Lower  
for control arm

Flange Hole Diameter [mm] 12  
Required quantity 2  
Thread Size 1 M16x1,5  
replacement in pairs recommended

**References**

GENERAL MOTORS 93161884  
Nissan 40160-00Q0C  
Renault 7701477385  
Vauxhall 44 31 869

Nissan 40160-00Q0A  
Opel 44 31 869  
Renault 8200667278

**Application info**

Nissan Primastar I (X83) (03/01--)  
Renault Trafic II (03/01--)

Opel Vivaro A (08/01--)  
Vauxhall Vivaro A (08/01-07/14)

**Ball joint****16-16 010 0011****MBJ0111****Notes**

Front Axle Left  
Front Axle Right



Required quantity 2  
Thread Size M12x1,25  
replacement in pairs recommended

**References**

Renault 401600004R

**Application info**

Renault Laguna III / Coupe / Grandtour (10/07-12/15)

Ball joint		16-16 010 0012	MBJ0112
<p><b>Notes</b></p> <p>Paired article number Required quantity replacement in pairs recommended</p>		<p>Front Axle Left with accessories 16-16 010 0013   MBJ0113 1</p>	
<p><b>References</b></p> <p>Mercedes-Benz 415 330 03 00 Renault 8200586561</p>		<p>Mercedes-Benz A 415 330 03 00</p>	
<p><b>Application info</b></p> <p>Mercedes-Benz BM 415 (Citan) (11/12--)</p>		<p>Renault Kangoo II (02/08--)</p>	
Ball joint		16-16 010 0013	MBJ0113
<p><b>Notes</b></p> <p>Paired article number Required quantity replacement in pairs recommended</p>		<p>Front Axle Right with accessories 16-16 010 0012   MBJ0112 1</p>	
<p><b>References</b></p> <p>Mercedes-Benz 415 330 02 00 Renault 8200586567</p>		<p>Mercedes-Benz A 415 330 02 00</p>	
<p><b>Application info</b></p> <p>Mercedes-Benz BM 415 (Citan) (11/12--)</p>		<p>Renault Kangoo II (02/08--)</p>	

**Ball joint**

16-16 010 0014

MBJ0114

**Notes**

Front Axle Left  
Front Axle Right  
with accessories

Required quantity  
replacement in pairs recommended

2

**References**

Renault 401609060R  
Renault 545006560R  
Renault 545009207R  
Renault 545014055R  
Renault 545016838R  
Renault 545019389R

Renault 545000399R  
Renault 545008682R  
Renault 545009795R  
Renault 545016101R  
Renault 545018194R

**Application info**

Renault Fluence (02/10--)  
Renault Scénic III (12/08--)

Renault Megane III (11/08--)

**Ball joint**

16-16 010 0015

MBJ0115

**Notes**

Front Axle Left  
Front Axle Right  
with accessories

Required quantity  
Thread Size 1  
replacement in pairs recommended

2

M12x1,25

**References**

Dacia 401602308R  
Dacia 545016746R  
Renault 545001535R  
Renault 545011697R  
Renault 545019969R

Dacia 545006542R  
Renault 545000138R  
Renault 545006542R  
Renault 545016746R



**Application info**

Dacia Duster I (04/10--)

Renault Duster I (01/11--)

**Ball joint**

16-16 010 0018

MBJ0116

**Notes**Front Axle Left  
Front Axle RightFlange Hole Diameter [mm] 12  
Required quantity 2  
replacement in pairs recommended**References**Renault 8200663581  
Renault 8200763290  
Renault 8200763296  
Renault 8200799709  
Renault 8200942392  
Renault 8200942403  
Renault 8200942406Renault 8200663584  
Renault 8200763294  
Renault 8200763301  
Renault 8200799710  
Renault 8200942396  
Renault 8200942405  
Renault 8200942423**Application info**

Renault Twingo II / Wind (03/07--)

**Ball joint**

16-16 010 0019

MBJ0117

**Notes**Front Axle Left  
Lower  
with right-hand thread  
Required quantity 1  
Thread Size M16x1,5  
replacement in pairs recommended

**References**

GENERAL MOTORS 93197233  
 Nissan 40160-00Q0K  
 Opel 44 19 219  
 Renault 401613416R  
 Vauxhall 93197233

Nissan 40160-00Q0E  
 Nissan 40160-00Q1C  
 Renault 401611363R  
 Renault 8200688877

**Application info**

Nissan Interstar II (X62B) (11/21--)  
 Opel Movano B (05/10--)  
 Vauxhall Movano Mk II (05/10--)

Nissan NV400 (11/11--)  
 Renault Master III (02/10--)

**Ball joint****16-16 010 0020****MBJ0118****Notes**

Front Axle Left  
 Front Axle Right  
 Lower

Cone Size [mm] 24  
 Outer Diameter [mm] 43  
 Required quantity 2  
 replacement in pairs recommended

**References**

GENERAL MOTORS 93194857  
 Opel 44 18 631  
 Vauxhall 44 18 631

Nissan 40160-00Q0B  
 Renault 7701070154

**Application info**

Nissan Interstar I (X70) (04/02--)  
 Renault Master II (03/98--)

Opel Movano A (07/98--)  
 Vauxhall Movano Mk I (10/98-12/10)

**Ball joint****16-16 010 0021****MBJ0305****Notes**

Front Axle Left  
 Front Axle Right

Height [mm] 80  
 Outer Diameter [mm] 39  
 Required quantity 2  
 replacement in pairs recommended



**References**

Renault 545046162R  
 Renault 545049968R  
 Renault 545050510R  
 Renault 545055711R

Renault 545046817R  
 Renault 545050399R  
 Renault 545052354R

**Application info**

Renault Clio IV (11/12--)

Renault Zoe (06/12--)

**Ball joint****16-16 010 0031****MBJ0394****Notes**

Required quantity

Thread Size

replacement in pairs recommended

Front Axle Right  
 Lower  
 with left-hand thread  
 1  
 M16x1,5

**References**

GENERAL MOTORS 95509251  
 Nissan 40160-00Q0F  
 Nissan 40160-00Q1B  
 Opel 44 23 894  
 Renault 401608374R  
 Vauxhall 95519325

GENERAL MOTORS 95519325  
 Nissan 40160-00Q0J  
 Opel 44 08 252  
 Renault 401602379R  
 Vauxhall 95509251

**Application info**

Nissan NV400 (11/11--)

Renault Master III (02/10--)

Opel Movano B (05/10--)

Vauxhall Movano Mk II (05/10--)

**Ball joint****16-16 010 0033/S****MBJ0457****Notes**

Cone Size [mm]

Outer Diameter [mm]

Required quantity

replacement in pairs recommended

Front Axle Left  
 Front Axle Right  
 Lower  
 with attachment material

18

38

2



**References**

Renault 545003037R  
 Renault 545047954R  
 Renault 8200298454  
 Renault 8200457208  
 Renault 8200679063

Renault 545017775R  
 Renault 545052737R  
 Renault 8200298455  
 Renault 8200457209  
 Renault 8200679067

**Application info**

Renault Captur I (06/13--)  
 Renault Scénic II (06/03-07/10)

Renault Mégane II (07/01--)

**Ball joint**

16-16 010 0034

MBJ0500

**Notes**

Front Axle Left  
 Front Axle Right  
 Lower  
 outer  
 2

Required quantity  
 replacement in pairs recommended



**References**

Renault 545042021R  
 Renault 545057449R

Renault 545045297R  
 Renault 545058992R

**Application info**

Renault Megane IV (11/15--)

**Ball joint**

16-16 010 0035

MBJ0491

**Notes**

Front Axle Left  
 Front Axle Right  
 Lower  
 with attachment material  
 2

Required quantity  
 replacement in pairs recommended



**References**

Dacia 545040280R  
Renault 545040280R

Dacia 545055413R  
Renault 545055413R

**Application info**

Dacia Duster I (04/10--)  
Renault Arkana (08/19--)  
Renault Kaptur (03/16--)

Dacia Duster II (10/17--)  
Renault Duster II (10/17--)

**Ball joint****16-16 010 0037****MBJ0504****Notes**

Front Axle Left  
Front Axle Right  
Lower  
for control arm  
outer

Required quantity  
replacement in pairs recommended

2

**References**

Renault 545051097R  
Smart 453 330 29 00  
Smart A 453 330 29 00

Renault 545057345R  
Smart 453 330 31 00  
Smart A 453 330 31 00

**Application info**

Renault Twingo III (09/14--)  
Smart Fortwo III (07/14--)

Smart Forfour II (07/14--)

**Ball joint****16-16 010 4264****MBJ0119****Notes**

Front Axle Left  
Front Axle Right  
Lower  
with accessories

Flange Hole Diameter [mm]  
Required quantity  
replacement in pairs recommended

10

2



**References**

Dacia 6001547918  
 Nissan 54501-00Q0L  
 Renault 7701462182  
 Renault 7701468883

Nissan 54501-00Q0G  
 Nissan 54501-00QAH  
 Renault 7701468411  
 Renault 7701472038

**Application info**

Dacia Solenza (02/03--)  
 Renault Clio I (05/90-09/98)  
 Renault Kangoo I (08/97--)  
 Renault R 11 (03/83-09/95)  
 Renault R 21 (03/86-07/97)  
 Renault Rapid/Express (07/85-10/99)  
 Renault Twingo I (03/93-10/12)

Nissan Kubistar (08/03--)  
 Renault Clio II / Thalia (02/98--)  
 Renault Mégane I / Scénic I (08/95-07/10)  
 Renault R 19 (01/88-08/03)  
 Renault R 9 (09/81-02/97)  
 Renault Super 5 (10/84-12/96)

**Ball joint****16-16 010 4281****MBJ0121****Notes**

Front Axle Left  
 Front Axle Right  
 Lower  
 with accessories

Length [mm] 20  
 Required quantity 2  
 Thread Size M12x1,25  
 replacement in pairs recommended

**References**



Renault 7701463230

Renault 7701465689

**Application info**

Renault Espace I (07/84-12/92)  
 Renault R 25 (04/84-12/93)

Renault Espace II (01/91-10/97)

Ball joint		16-16 010 4295	MBJ0122
<b>Notes</b>  Front Axle Left Front Axle Right Upper with accessories  Required quantity 2 Thread Size M12x1,25 replacement in pairs recommended			
<b>References</b> Renault 7700706628 Renault 7701463229 Renault 7701469228			
<b>Application info</b> Renault Espace I (07/84-12/92) Renault Espace II (01/91-10/97) Renault R 25 (04/84-12/93)			
Ball joint		18-16 010 0001	MBJ0123
<b>Notes</b>  Front Axle Left Front Axle Right Lower  Height [mm] 108 Outer Diameter [mm] 48 Required quantity 2 Thread Size M14x2,0 replacement in pairs recommended			
<b>References</b> Jaguar XR852807 Jaguar XR852808			
<b>Application info</b> Jaguar S-Type (CCX) (10/98-12/08)			

**Ball joint****216 010 0004****MBJ0126****Notes**

Front Axle Left  
 Front Axle Right  
 Lower  
 with accessories

Required quantity

2

Thread Size

M12x1,25

replacement in pairs recommended

**References**

Fiat 46543045

Fiat 46779293

Fiat 46842581

Fiat 7081835

Fiat 7082812

**Application info**

Fiat Doblo (119, 223) (11/00--)

Fiat Palio / Albea / Siena / Strada (04/96--)

**Ball joint****216 010 0006/HD****MBJ0127HD****Notes**

Carbon Neutral  
 Front Axle Left  
 Front Axle Right  
 Upper

Required quantity

2

Thread Size

M16x1,5

reinforced version

replacement in pairs recommended

**References**

Iveco 5 0033 4710

Iveco 5 0033 4711

Iveco 5 0033 4713

Iveco 5 0033 4714

Iveco 5 0034 4887

Iveco 5 0034 4888

Iveco 5 0037 9801

Iveco 5 0037 9802

**Application info**

Iveco Daily III (11/97-10/09)

Iveco Daily IV (05/06-03/12)

Iveco Daily V (09/11-02/14)



## Ball joint

216 010 0007/HD

MBJ0128HD

## Notes

Carbon Neutral  
Front Axle Left  
Front Axle Right  
Lower

Required quantity 2  
Thread Size M18x1,5  
reinforced version  
replacement in pairs recommended



## References

Iveco 42551289  
Iveco 5 0033 4716

Iveco 42551290  
Iveco 5 0033 4717

## Application info

Iveco Daily III (11/97-10/09)  
Iveco Daily V (09/11-02/14)

Iveco Daily IV (05/06-03/12)

## Ball joint

216 010 0008

MBJ0129

## Notes

Front Axle Left  
Front Axle Right  
with accessories

Required quantity 2  
replacement in pairs recommended



## References

Fiat 50705465  
Fiat 51795260  
Fiat 51827737  
Lancia 50705465  
Lancia 51795260  
Lancia 51827737

Fiat 50705544  
Fiat 51827736  
Fiat 51827738  
Lancia 50705544  
Lancia 51827736  
Lancia 51827738

## Application info

Fiat Bravo (198) (11/06--)  
Lancia Delta III (08/08-08/14)

Fiat Stilo (10/01-11/10)

<b>Ball joint</b>	<b>216 010 0009</b>	<b>MBJ0130</b>
-------------------	---------------------	----------------

**Notes**

Front Axle Left  
Front Axle Right  
with accessories

Required quantity  
2

replacement in pairs recommended



<b>References</b>	
Fiat 51810664	Fiat 51810665
Fiat 51885660	Fiat 51885737
Fiat 51932035	Fiat 51932036
Fiat 52008282	Fiat 52008283
Fiat 52026316	Fiat 52026317
Opel 3 52 537	Opel 3 52 538
Vauxhall 95514536	Vauxhall 95514537

<b>Application info</b>	
Fiat 500L (09/12--)	Fiat Doblo (263) (11/09--)
Opel Combo D (02/12--)	Vauxhall Combo Mk III (07/06--)

<b>Ball joint</b>	<b>216 010 0010</b>	<b>MBJ0319</b>
-------------------	---------------------	----------------

**Notes**

Front Axle Left  
Front Axle Right

Outer Diameter [mm]  
45

Required quantity  
2

Thread Size  
M12x1,5

replacement in pairs recommended



**References**

Chrysler 5085914AB	Chrysler 5085914AD
Chrysler K05085914AB	Chrysler K05085914AC
Dodge 05090033AA	Dodge 05090033AB
Dodge 5085914AD	Dodge 5090033AA
Dodge 5090033AB	Fiat K05085914AB
Fiat K05085914AC	Fiat K05085914AD
Fiat K05090033AA	Fiat K05090033AB
Lancia K05090033AA	Lancia K05090033AB

**Application info**

Chrysler Sebring (JS) (09/06-12/10)	Dodge Avenger II (06/07-12/14)
Dodge Journey (06/08--)	Fiat Freemont (JC) (08/11--)
Lancia Flavia (03/12-12/14)	

**Ball joint**

216 010 0011

MBJ0492

**Notes**

Front Axle Left  
 Front Axle Right  
 Upper  
 Required quantity 2  
 Thread Size 1 M18x1,5  
 Thread Size 2 M20x1

replacement in pairs recommended







**References**



Iveco 504212584	Iveco 504212586
-----------------	-----------------

**Application info**

Iveco Daily III (11/97-10/09)	Iveco Daily IV (05/06-03/12)
Iveco Daily V (09/11-02/14)	Iveco Daily VI (03/14--)

Ball joint		216 010 0012	MBJ0343														
<p><b>Notes</b></p> <p>Front Axle Left Front Axle Right</p> <p>Required quantity 2</p> <p>replacement in pairs recommended</p>																	
<p><b>References</b></p> <table border="0"> <tr> <td>Fiat 51849600</td> <td>Fiat 51849602</td> </tr> <tr> <td>Fiat 51928527</td> <td>Fiat 51928536</td> </tr> <tr> <td>Fiat 51957400</td> <td>Fiat 51957401</td> </tr> <tr> <td>Lancia 51890706</td> <td>Lancia 51890709</td> </tr> <tr> <td>Lancia 51905057</td> <td>Lancia 51905058</td> </tr> <tr> <td>Lancia 51932474</td> <td>Lancia 51932475</td> </tr> <tr> <td>Lancia 51956709</td> <td>Lancia 51956712</td> </tr> </table>				Fiat 51849600	Fiat 51849602	Fiat 51928527	Fiat 51928536	Fiat 51957400	Fiat 51957401	Lancia 51890706	Lancia 51890709	Lancia 51905057	Lancia 51905058	Lancia 51932474	Lancia 51932475	Lancia 51956709	Lancia 51956712
Fiat 51849600	Fiat 51849602																
Fiat 51928527	Fiat 51928536																
Fiat 51957400	Fiat 51957401																
Lancia 51890706	Lancia 51890709																
Lancia 51905057	Lancia 51905058																
Lancia 51932474	Lancia 51932475																
Lancia 51956709	Lancia 51956712																
<p><b>Application info</b></p> <table border="0"> <tr> <td>Chrysler Ypsilon (05/11--)</td> <td>Fiat Panda III (02/12--)</td> </tr> <tr> <td>Lancia Ypsilon (846) (05/11--)</td> <td></td> </tr> </table>				Chrysler Ypsilon (05/11--)	Fiat Panda III (02/12--)	Lancia Ypsilon (846) (05/11--)											
Chrysler Ypsilon (05/11--)	Fiat Panda III (02/12--)																
Lancia Ypsilon (846) (05/11--)																	
Ball joint		216 010 0015	MBJ0442														
<p><b>Notes</b></p> <p>Front Axle Left Front Axle Right with attachment material</p> <p>Required quantity 2</p> <p>replacement in pairs recommended</p>																	
<p><b>References</b></p> <table border="0"> <tr> <td>Fiat 52026562</td> <td>Fiat 52055603</td> </tr> </table>				Fiat 52026562	Fiat 52055603												
Fiat 52026562	Fiat 52055603																
<p><b>Application info</b></p> <p>Fiat Tipo (356) (10/15--)</p>																	

Ball joint		216 010 0016	MBJ0459
<b>Notes</b>  Front Axle Left Front Axle Right with attachment material  Required quantity replacement in pairs recommended  2			
<b>References</b> Fiat 51945321		Jeep 51945321	
<b>Application info</b> Fiat 500X (09/14--))		Jeep Renegade (BU, B1) (07/14--))	
Ball joint		216 010 4072	MBJ0135
<b>Notes</b>  Front Axle Left Front Axle Right Upper  Outer Diameter [mm] Required quantity Thread Size 1 Thread Size 2 replacement in pairs recommended  48 2 M18x1,5 M20x1,5			
<b>References</b> Fiat 93802242 Fiat 93807320 Fiat 93807545 Iveco 9380 2242 Iveco 9380 7545		Fiat 93804061 Fiat 93807542 Iveco 5 0347 6406 Iveco 9380 7320 Peugeot 3608.28	
<b>Application info</b> Iveco Daily I (01/78-05/99) Iveco Daily III (11/97-10/09)		Iveco Daily II (01/89-08/09) Iveco Daily IV (05/06-03/12)	

Ball joint		26-16 010 0000	MBJ0136
<b>Notes</b>  Front Axle Left Front Axle Right with accessories  Required quantity 2 Thread Size 1 M12x1,25 replacement in pairs recommended			
<b>References</b> Chevrolet 96535089		Daewoo 96535089	
<b>Application info</b> Chevrolet Astro I (02/03-05/08) Chevrolet Aveo II (03/11--)		Chevrolet Aveo I (01/03--) Daewoo Kalos (09/02--)	
Ball joint		26-16 010 0004	MBJ0138
<b>Notes</b>  Front Axle Left Front Axle Right with accessories  Cone Size [mm] 18 Required quantity 2 replacement in pairs recommended			
<b>References</b> Buick 96490218 Daewoo 96490218		Chevrolet 96490218	
<b>Application info</b> Chevrolet Lacetti (03/03--) Daewoo Lacetti (02/02--)		Chevrolet Nubira (01/05-12/11) Daewoo Nubira (KLAN) (07/03--)	

Ball joint		28-16 010 0000	MBJ0140
<b>Notes</b>			
	Front Axle Left		
	Front Axle Right		
	Lower		
Outer Diameter [mm]	40		
Required quantity	2		
replacement in pairs recommended			

References	
Hyundai 54530-07000	Hyundai 54530-0X000
Kia 54530 07000	

Application info	
Hyundai i10 I (10/07--)	Kia Picanto I (04/04--)

Ball joint		28-16 010 0001	MBJ0141
<b>Notes</b>			
	Front Axle Left		
	Front Axle Right		
	Lower		
Required quantity	2		
replacement in pairs recommended			

References	
Hyundai 54530-3J000	Hyundai 54530-4D000
Kia 54530 3J000	Kia 54530 4D000

Application info	
Hyundai H-1 II (09/07--)	Hyundai ix55 (09/06--)
Kia Carnival III (09/05--)	

**Ball joint**

28-16 010 0010

MBJ0469

**Notes**

Front Axle Left  
 Front Axle Right  
 Lower

Required quantity  
 replacement in pairs recommended

2

**References**

Hyundai 54530-2K000

Kia 54530-2K000

**Application info**

Hyundai i10 II (08/13--)

Hyundai i10 III (09/19--)

Kia Picanto II (05/11--)

Kia Rio III (09/10--)

Kia Soul I (01/09--)

**Ball joint**

28-16 010 0011/HD

MBJ0466HD

**Notes**

Carbon Neutral  
 Front Axle Left  
 Front Axle Right  
 for control arm

Required quantity  
 reinforced version  
 replacement in pairs recommended

2

**References**

Hyundai 54530-2K000

Kia 54530 H8000

Kia 54530-2K000

**Application info**

Hyundai i10 II (08/13--)

Hyundai i10 III (09/19--)

Kia Picanto II (05/11--)

Kia Rio III (09/10--)

Kia Rio IV (01/17--)

Kia Soul I (01/09--)

Kia Soul III (SK3) (01/19--)

Kia Stonic (07/17--)



<b>Ball joint</b>	<b>28-16 010 0011</b>	<b>MBJ0466</b>
-------------------	-----------------------	----------------

**Notes**

Front Axle Left  
Front Axle Right  
for control arm

Required quantity  
replacement in pairs recommended

2



**References**

Kia 54530H8000

**Application info**

Kia Rio IV (01/17--)

Kia Stonic (07/17--)

<b>Ball joint</b>	<b>28-16 010 0012</b>	<b>MBJ0470</b>
-------------------	-----------------------	----------------

**Notes**

Front Axle Right  
Lower  
outer

Paired article number  
Required quantity  
replacement in pairs recommended

28-16 010 0013 | MBJ0471

1



**References**

Hyundai 54530-C1100  
Kia 54530 C1100

Hyundai 54530-D7100  
Kia 54530 D7100



**Application info**

Hyundai Sonata VII (06/14--)

Hyundai Tucson II (05/15--)

Kia Optima IV (09/15--)

Kia Sportage IV (09/15--)

Ball joint		28-16 010 0013	MBJ0471
<p><b>Notes</b></p> <p>Front Axle Left Lower outer</p> <p>Paired article number Required quantity replacement in pairs recommended</p>			
<p><b>References</b></p> <p>Hyundai 54530-C1000 Kia 54530 C1000</p>		<p>Hyundai 54530-D7000 Kia 54530 D7000</p>	
<p><b>Application info</b></p> <p>Hyundai Sonata VII (06/14--) Kia Optima IV (09/15--)</p>		<p>Hyundai Tucson II (05/15--) Kia Sportage IV (09/15--)</p>	
Ball joint		28-16 010 0014	MBJ0468
<p><b>Notes</b></p> <p>Front Axle Left Front Axle Right Lower</p> <p>Required quantity replacement in pairs recommended</p>			
<p><b>References</b></p> <p>Hyundai 51760-2R000</p>		<p>Kia 51760 2R000</p>	
<p><b>Application info</b></p> <p>Hyundai i30 I (10/07-06/12)</p>		<p>Kia Cee'd I (12/06-02/13)</p>	

**Ball joint**

28-16 010 0016

MBJ0485

**Notes**

Front Axle Left  
 Front Axle Right  
 Lower

Required quantity  
 replacement in pairs recommended

2

**References**

Kia 54530 G6000

**Application info**

Kia Picanto III (03/17--)

**Ball joint**

30-16 010 0021

MBJ0156

**Notes**

Front Axle Left  
 Front Axle Right  
 Upper  
 with accessories

Outer Diameter [mm]

45

Required quantity

2

Thread Size

M14x1,5

replacement in pairs recommended

**References**

Toyota 43310-60010

Toyota 43310-60020

Toyota 43310-60030

Toyota 43310-60050

**Application info**

Toyota Land Cruiser (J12) (09/02-12/10)

**Ball joint****30-16 010 0029****MBJ0158****Notes**

Front Axle Left  
 Front Axle Right  
 Lower  
 with attachment material

Required quantity

2

Thread Size

M16x1,5

replacement in pairs recommended

**References**

Toyota 43330-29125

Toyota 43330-29155

Toyota 43330-29295

Toyota 43330-29515

Toyota 43330-29535

Toyota 43340-29105

**Application info**

Toyota Hiace II (11/82-11/89)

Toyota Hiace III (08/87-02/05)

Toyota Hiace IV (08/95-12/12)

**Ball joint****30-16 010 0034****MBJ0159****Notes**

Front Axle Left  
 Front Axle Right  
 Lower

Required quantity

2

Thread Size

M14x1,5

replacement in pairs recommended

**References**

Toyota 43330-02020

Toyota 43330-09030

Toyota 43330-09130

Toyota 43330-19095

Toyota 43330-29265

Toyota 43330-29315

Toyota 43330-29375

**Application info**

Toyota Avensis (T22) (09/97-02/03)

Toyota Carina (T19) (02/92-09/97)

Toyota Celica (T20) (09/93-11/99)

Toyota Corolla (E10) (06/91-12/99)

Toyota Corona (T190) (10/91-04/98)

Toyota Picnic (05/96-12/01)

Ball joint	30-16 010 0045	MBJ0164
------------	----------------	---------

<p><b>Notes</b></p> <p>Front Axle Left Lower with accessories</p> <p>Paired article number 30-16 010 0050   MBJ0165</p> <p>Required quantity 1</p> <p>Thread Size M16x1,5</p> <p>replacement in pairs recommended</p>	
---	--

<p><b>References</b></p> <p>Toyota 43340-39325</p> <p>Toyota 43340-39356</p>	<p>Toyota 43340-39355</p> <p>Toyota 43340-39465</p>
--	---

<p><b>Application info</b></p> <p>Toyota 4 Runner II (08/87-12/96)</p> <p>Toyota Land Cruiser (J9) (04/95--)</p>	<p>Toyota 4 Runner III (11/95-07/03)</p>
--	--

Ball joint	30-16 010 0050	MBJ0165
------------	----------------	---------

<p><b>Notes</b></p> <p>Front Axle Right Lower with accessories</p> <p>Paired article number 30-16 010 0045   MBJ0164</p> <p>Required quantity 1</p> <p>Thread Size M16x1,5</p> <p>replacement in pairs recommended</p>	
--	--

<p><b>References</b></p> <p>Toyota 43330-39415</p> <p>Toyota 43330-39466</p>	<p>Toyota 43330-39465</p> <p>Toyota 43330-39585</p>
--	---

<p><b>Application info</b></p> <p>Toyota 4 Runner II (08/87-12/96)</p> <p>Toyota Land Cruiser (J9) (04/95--)</p>	<p>Toyota 4 Runner III (11/95-07/03)</p>
--	--

**Ball joint****30-16 010 0051****MBJ0166****Notes**

Front Axle Left  
 Front Axle Right  
 Lower  
 with accessories

Required quantity

2

Thread Size

M14x1,5

replacement in pairs recommended

**References**

Toyota 43330-09360

**Application info**

Toyota Avensis (T25) (01/03-11/08)

Toyota Corolla (E12) (08/00-12/08)

Toyota Corolla Verso (03/04-04/09)

**Ball joint****30-16 010 0069****MBJ0167****Notes**

Front Axle Left  
 Front Axle Right  
 Upper  
 with accessories

Outer Diameter [mm]

43

Required quantity

2

Thread Size

M14x1,5

replacement in pairs recommended

**References**

Toyota 43310-39016

Toyota 43310-39085

**Application info**

Toyota 4 Runner III (11/95-07/03)

Toyota Land Cruiser (J9) (04/95--)

## Ball joint

30-16 010 0083/HD

MBJ0498HD

## Notes

Carbon Neutral  
 Front Axle Left  
 Front Axle Right  
 Lower

Required quantity  
 reinforced version  
 replacement in pairs recommended

2



## References

Citroën 16 141 914 80  
 Citroën 3520.Q2  
 Citroën B0 007 701 80  
 Daihatsu 48068-09041  
 Peugeot 16 14 191 480  
 Peugeot 3520.Q2  
 Peugeot B0 00 770 180  
 Subaru 4806859145  
 Toyota 48068-09015  
 Toyota 48068-09040  
 Toyota 48068-09150  
 Toyota 48068-0H020  
 Toyota 48068-59035  
 Toyota 48068-59095  
 Toyota 48068-59145  
 Toyota 48068-79018  
 Toyota 48069-09030  
 Toyota 48069-09041  
 Toyota 48069-0H010  
 Toyota 48069-0H021  
 Toyota 48069-59055  
 Toyota 48069-59125  
 Toyota 48069-59145  
 Toyota 48069-79018

Citroën 16 141 916 80  
 Citroën 3521.L3  
 Citroën B0 007 702 80  
 Daihatsu 48069-09041  
 Peugeot 16 14 191 680  
 Peugeot 3521.L3  
 Peugeot B0 00 770 280  
 Subaru 4806959135  
 Toyota 48068-09030  
 Toyota 48068-09041  
 Toyota 48068-0H010  
 Toyota 48068-0H021  
 Toyota 48068-59055  
 Toyota 48068-59135  
 Toyota 48068-79015  
 Toyota 48069-09015  
 Toyota 48069-09040  
 Toyota 48069-09140  
 Toyota 48069-0H020  
 Toyota 48069-59035  
 Toyota 48069-59095  
 Toyota 48069-59135  
 Toyota 48069-79015

**Application info**

Citroën C1 (06/05-09/14)

Daihatsu Charade V (05/11--)

Peugeot 108 (05/14--)

Toyota Aygo I (02/05-05/14)

Toyota Prius C (NHP10) (09/11--)

Toyota Verso S (NCP12, NSP12) (11/10-10/16)

Toyota Yaris II (01/05-12/14)

Toyota iQ (11/08-12/15)

Citroën C1 II (04/14--)

Peugeot 107 (06/05-05/14)

Subaru Trezia (11/10--)

Toyota Aygo II (05/14--)

Toyota Urban Cruiser (NCP11) (07/07-03/16)

Toyota Yaris I (01/99-12/05)

Toyota Yaris III (12/10--)

**Ball joint****30-16 010 0084/HD****MBJ0503HD****Notes**Carbon Neutral  
Front Axle Left  
Front Axle Right  
Lower  
outer

Required quantity

2

Thread Size 1

M14x1,5

Thread Size 2

M12x1,25

reinforced version

replacement in pairs recommended

**References**

Lexus 43330-49185

Toyota 43330-49185

**Application info**

Lexus CT (ZWA1) (12/10--)

Toyota Prius III (06/08--)

**Ball joint****30-16 010 0085****MBJ0493****Notes**Front Axle Left  
Front Axle Right  
Lower  
for control arm  
outer  
with retaining ring

Required quantity

2

replacement in pairs recommended

**References**

Toyota 43330-49225



**Application info**

Toyota RAV 4 V (\_A5\_) (12/18--)

Toyota bZ4X (12/21--)

**Ball joint**

30-16 010 0086/HD

MBJ0489HD

**Notes**

Carbon Neutral  
Front Axle Left  
Front Axle Right  
Lower  
for control arm  
outer

Required quantity 2  
replacement in pairs recommended



**References**

Toyota 43330-09A50

**Application info**

Toyota Aygo III (X) (10/21--)

Toyota Corolla (\_E21\_) (10/18--)

Toyota Yaris IV (02/20--)

**Ball joint**

30-16 010 0087

MBJ0499

**Notes**

Front Axle Left  
Front Axle Right  
Lower  
for control arm

Height [mm] 100.3  
Outer Diameter [mm] 47  
Required quantity 2  
Thread Size M16x1,5  
replacement in pairs recommended



**References**

Toyota 43330-09295

Toyota 43330-09490

Toyota 43330-09510

Toyota 43330-09A20

**Application info**



Toyota Fortuner (\_N5\_,\_N6\_) (06/04-09/15)

Toyota Fortuner (\_N15\_,\_N16\_) (05/15--)

Toyota Hilux (Gun1, Gun13) (05/15--)

Toyota Hilux (KUN) (08/04--)

Toyota Hilux VIII (\_N1\_) (05/15--)

Ball joint		30-16 010 0088	MBJ0512
<b>Notes</b>  Front Axle Left Front Axle Right outer  Required quantity 2  replacement in pairs recommended			
<b>References</b> Lexus 43330-49235 Toyota 43330-49235		Subaru 4333049235	
<b>Application info</b> Lexus NX II (_A2_, _H2_) (09/21--) Toyota RAV 4 V (_A5_) (12/18--)		Subaru Solterra (06/22--) Toyota bZ4X (12/21--)	
Ball joint		31-16 010 0000	MBJ0169
<b>Notes</b>  Front Axle Left Front Axle Right Lower  Outer Diameter [mm] 40 Required quantity 2 Thread Size 1 M12x1,25  replacement in pairs recommended			
<b>References</b> Honda 51210-S5A-J10 Honda 51210-S5T-Z00 Honda 51215-S5A-J10 Honda 51215-S5T-Z00		Honda 51210-S5A-J30 Honda 51210-S6D-G10 Honda 51215-S5A-J30 Honda 51215-S6D-G10	
<b>Application info</b> Honda Civic VII (03/99-04/06)			

**Ball joint** **31-16 010 0001** **MBJ0170**

**Notes**

Front Axle Left  
 Front Axle Right  
 Lower

Outer Diameter [mm] 40  
 Required quantity 2  
 Thread Size M12x1,25  
 replacement in pairs recommended



**References**

- |                     |                     |
|---------------------|---------------------|
| Honda 51220-FF1-000 | Honda 51220-SA0-A01 |
| Honda 51220-SB0-003 | Honda 51220-SB0-023 |
| Honda 51220-SBO-023 | Honda 51220-SE0-000 |
| Honda 51220-SE0-003 | Honda 51220-SF1-000 |
| Honda 51220-SF1-100 | Honda 51220-SH0-A01 |
| Honda 51220-SH3-003 | Honda 51220-SK7-003 |
| Honda 51220-SK7-013 | Honda 51220-SM0-A01 |

**Application info**

- |                                |                                 |
|--------------------------------|---------------------------------|
| Honda Accord III (11/85-12/89) | Honda CRX II (10/87-02/92)      |
| Honda Civic IV (09/87-02/95)   | Honda Prelude III (04/86-11/96) |
| Honda Prelude IV (12/91-02/97) | Honda Prelude V (10/96-04/01)   |

**Ball joint** **31-16 010 0002** **MBJ0171**

**Notes**

Front Axle Left  
 Front Axle Right  
 Lower

Outer Diameter [mm] 42  
 Required quantity 2  
 Thread Size M12x1,25  
 replacement in pairs recommended



**References**

Honda 51220-S0A-J01  
 Honda 51220-S84-305  
 Honda 51220-S84-A02  
 Honda 51220-SM1-A02  
 Honda 51220-SM4-013  
 Rover GSJ404

Honda 51220-S4K-A00  
 Honda 51220-S84-A01  
 Honda 51220-SM1-A01  
 Honda 51220-SM4-003  
 Honda 52220-SF1-003

**Application info**

Honda Accord IV (05/89-02/94)  
 Honda Accord VII (03/97-09/05)  
 Rover 600 (RH) (08/93-10/00)

Honda Accord V / VI (06/92-12/98)  
 Honda Shuttle I (06/94-06/04)

**Ball joint**

31-16 010 0013

MBJ0175

**Notes**

Front Axle Left  
 Front Axle Right  
 Lower  
 Outer Diameter [mm] 35  
 Required quantity 2  
 Thread Size M12x1,25

replacement in pairs recommended



**References**

Honda 51220-SAA-013  
 Honda 51360-SAA-G02

Honda 51350-SAA-G02

**Application info**

Honda HR-V I (03/99--)

Honda Jazz II (06/01-12/08)

**Ball joint**

31-16 010 0015

MBJ0176

**Notes**

Front Axle Left  
 Front Axle Right  
 Lower  
 Outer Diameter [mm] 43  
 Required quantity 2  
 Thread Size M12x1,25

replacement in pairs recommended



**References**

Honda 51220-SDA-A02

**Application info**

Honda Accord VIII (09/02--)

Honda FR-V (08/04--)

**Ball joint**

31-16 010 0022

MBJ0473

**Notes**

Front Axle Left  
 Front Axle Right  
 Lower  
 outer

Required quantity  
 replacement in pairs recommended



**References**

Honda 06510-TBA-A00

Honda 51220-TBA-A01

**Application info**

Honda Civic X (09/15--)

**Ball joint**

31-16 010 0023

MBJ0475

**Notes**

Front Axle Left  
 Front Axle Right  
 Lower  
 outer

Required quantity  
 replacement in pairs recommended



**References**

Honda 51220-TEA-T01

**Application info**

Honda Civic X (09/15--)

**Ball joint**

31-16 010 0025/HD

MBJ0488HD

**Notes**

Carbon Neutral  
 Front Axle Left  
 Front Axle Right  
 Lower

Required quantity  
 replacement in pairs recommended

2



**References**

Honda 51220-TNY-J01

**Application info**

Honda CR-V V (12/16--)

**Bracket, control arm**

300 311 2604/HD

MBC0003HD

**Notes**

Carbon Neutral  
 Front Axle Left  
 Front Axle Right  
 Set  
 with accessories  
 with rubber mount

Required quantity  
 reinforced version

2



**References**

BMW 1 095 277	BMW 1 095 278
BMW 1 096 284	BMW 1 096 983
BMW 1 096 984	BMW 31 12 1 095 277
BMW 31 12 1 095 278	BMW 31 12 1 096 284
BMW 31 12 1 096 983	BMW 31 12 1 096 984
BMW 31 12 4 004 359	BMW 31 12 4 004 360
BMW 31 12 6 750 221	BMW 31 12 6 750 222
BMW 31 12 6 751 435	BMW 31 12 6 751 436
BMW 31 12 6 753 059	BMW 31 12 6 753 060
BMW 31 12 6 754 899	BMW 31 12 6 754 900
BMW 31 12 6 757 623	BMW 31 12 6 777 850
BMW 31 12 6 783 376	BMW 4 004 359
BMW 4 004 360	BMW 6 750 221
BMW 6 750 222	BMW 6 751 435
BMW 6 751 436	BMW 6 753 059
BMW 6 753 060	BMW 6 754 899
BMW 6 754 900	BMW 6 757 623
BMW 6 777 850	BMW 6 783 376
BMW (Brilliance) 1 095 277	BMW (Brilliance) 1 095 278
BMW (Brilliance) 1 096 284	BMW (Brilliance) 1 096 983
BMW (Brilliance) 1 096 984	BMW (Brilliance) 31 12 1 095 277
BMW (Brilliance) 31 12 1 095 278	BMW (Brilliance) 31 12 1 096 284
BMW (Brilliance) 31 12 1 096 983	BMW (Brilliance) 31 12 1 096 984
BMW (Brilliance) 31 12 4 004 359	BMW (Brilliance) 31 12 4 004 360
BMW (Brilliance) 31 12 6 750 221	BMW (Brilliance) 31 12 6 750 222
BMW (Brilliance) 31 12 6 751 435	BMW (Brilliance) 31 12 6 751 436
BMW (Brilliance) 31 12 6 753 059	BMW (Brilliance) 31 12 6 753 060
BMW (Brilliance) 31 12 6 754 899	BMW (Brilliance) 31 12 6 754 900
BMW (Brilliance) 31 12 6 757 623	BMW (Brilliance) 31 12 6 777 850
BMW (Brilliance) 31 12 6 783 376	BMW (Brilliance) 4 004 359
BMW (Brilliance) 4 004 360	BMW (Brilliance) 6 750 221
BMW (Brilliance) 6 750 222	BMW (Brilliance) 6 751 435
BMW (Brilliance) 6 751 436	BMW (Brilliance) 6 753 059
BMW (Brilliance) 6 753 060	BMW (Brilliance) 6 754 899
BMW (Brilliance) 6 754 900	BMW (Brilliance) 6 757 623
BMW (Brilliance) 6 777 850	BMW (Brilliance) 6 783 376

**Application info**

BMW 3 (E46) (12/97-12/07)	BMW Z4 (E85) (09/02-12/09)
BMW Z4 (E86) (03/06-01/09)	

## Control arm

116 050 0031/HD

MCA0150HD

## Notes

Aluminium  
Carbon Neutral  
Control Arm  
Front  
Front Axle Left  
Front Axle Right  
Lower  
with accessories  
with rubber mount

Cone Size [mm]

16

Length [mm]

365

Replace in pairs only

Required quantity

2

reinforced version

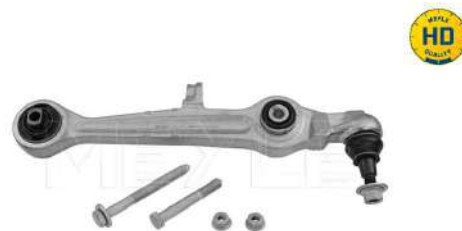

## References

Audi 4B0 407 151

Audi 4B3 407 151 C

Audi 4B3 407 151 F

Audi (FAW) 4B0 407 151

Audi (FAW) 4B3 407 151 F

Skoda 4B0 407 151

Skoda 4B3 407 151 C

Skoda 4B3 407 151 F

Volkswagen 4B0 407 151

Volkswagen 4B3 407 151 C

Volkswagen 4B3 407 151 F

Volkswagen (SVW) 4B3 407 151 K

Audi 4B3 407 151 A

Audi 4B3 407 151 E

Audi 4B3 407 151 K

Audi (FAW) 4B3 407 151 C

Audi (FAW) 4B3 407 151 K

Skoda 4B3 407 151 A

Skoda 4B3 407 151 E

Skoda 4B3 407 151 K

Volkswagen 4B3 407 151 A

Volkswagen 4B3 407 151 E

Volkswagen 4B3 407 151 K

## Application info

Audi A4 I (8D\_) (11/94-12/02)

Audi A8 I (4D\_) (03/94-12/05)

Volkswagen Passat (3B\_) (08/96-12/05)

Audi A6 II (4B, C5) (01/97-12/05)

Skoda Superb I (3U) (12/01-03/08)



## Control arm

116 050 0032/HD

MCA0151HD

## Notes

Carbon Neutral  
Cast Steel  
Control Arm  
Front Axle Left  
with rubber mount  
without ball joint

Article number of recommended accessories 100 654 0008  
Paired article number 116 050 0033/HD | MCA0152HD  
Replace in pairs only  
Required quantity 1  
reinforced version



## References

Audi 1K0 407 151 AC  
Audi 1K0 407 151 AK  
Seat 1K0 407 151 AC  
Seat 1K0 407 151 AK  
Seat 1K0 407 151 R  
Skoda 1K0 407 151 T  
Volkswagen 1K0 407 151 M

Audi 1K0 407 151 AD  
Audi 1K0 407 151 BF  
Seat 1K0 407 151 AD  
Seat 1K0 407 151 BF  
Skoda 1K0 407 151 AC  
Volkswagen 1K0 407 151 AC  
Volkswagen 1K0 407 151 R

## Application info

Audi A3 II (8P\_) (05/03-12/15)  
Skoda Octavia II (1Z\_) (02/04-06/13)  
Volkswagen Caddy III (2KA, 2KB) (03/04-05/15)  
Volkswagen Golf V (1K1, 1K5, 5M1) (10/03-08/14)  
Volkswagen Jetta III (1K2) (09/04-12/13)  
Volkswagen Touran I (1T1/2/3) (02/03-05/15)

Seat Leon II / Toledo III / Altea (1P\_ ,5P\_) (03/04--)  
Skoda Superb II (3T) (03/08-05/15)  
Volkswagen Eos (03/06-08/15)  
Volkswagen Golf VI (5K1, 517, AJ5) (10/08-05/16)  
Volkswagen Scirocco III (137) (05/08-11/17)

## Control arm

116 050 0033/HD

MCA0152HD

## Notes

Carbon Neutral  
 Cast Steel  
 Control Arm  
 Front Axle Right  
 with rubber mount  
 without ball joint

Article number of recommended accessory 100 654 0008  
 Paired article number 116 050 0032/HD | MCA0151HD  
 Replace in pairs only  
 Required quantity 1  
 reinforced version



## References



Audi 1K0 407 152 AC  
 Audi 1K0 407 152 AK  
 Seat 1K0 407 152 AC  
 Seat 1K0 407 152 AK  
 Seat 1K0 407 152 R  
 Skoda 1K0 407 152 T  
 Volkswagen 1K0 407 152 M

Audi 1K0 407 152 AD  
 Audi 1K0 407 152 BF  
 Seat 1K0 407 152 AD  
 Seat 1K0 407 152 BF  
 Skoda 1K0 407 152 AC  
 Volkswagen 1K0 407 152 AC  
 Volkswagen 1K0 407 152 R

## Application info

Audi A3 II (8P\_) (05/03-12/15)  
 Skoda Octavia II (1Z\_) (02/04-06/13)  
 Volkswagen Caddy III (2KA, 2KB) (03/04-05/15)  
 Volkswagen Golf V (1K1, 1K5, 5M1) (10/03-08/14)  
 Volkswagen Jetta III (1K2) (09/04-12/13)  
 Volkswagen Touran I (1T1/2/3) (02/03-05/15)

Seat Leon II / Toledo III / Altea (1P\_, 5P\_) (03/04--)  
 Skoda Superb II (3T) (03/08-05/15)  
 Volkswagen Eos (03/06-08/15)  
 Volkswagen Golf VI (5K1, 517, AJ5) (10/08-05/16)  
 Volkswagen Scirocco III (137) (05/08-11/17)

Control arm		116 050 0042/HD	MCA0153HD
<p><b>Notes</b></p> <p>Aluminium Carbon Neutral Control Arm Front Front Axle Left Upper with accessories with rubber mount</p> <p>Length [mm] 301 Paired article number 116 050 0063/HD   MCA0161HD Replace in pairs only Required quantity 1 reinforced version</p>			
<p><b>References</b></p> <p>Audi 4E0 407 505 B Audi 4E0 407 505 F Audi (FAW) 4E0 407 505 E Volkswagen 4E0 407 505 B</p>		<p>Audi 4E0 407 505 E Audi (FAW) 4E0 407 505 B Audi (FAW) L4E0 407 505 B Volkswagen 4E0 407 505 E</p>	
<p><b>Application info</b></p> <p>Audi A6 III (4F2, 4FH, 4F5) (04/04-08/11) Volkswagen Phaeton (3D) (04/02-03/16)</p>		<p>Audi A8 II (4E_) (10/02-12/10)</p>	
Control arm		116 050 0043/HD	MCA0154HD
<p><b>Notes</b></p> <p>Aluminium Carbon Neutral Control Arm Front Front Axle Left Front Axle Right Lower with accessories with rubber mount</p> <p>Length [mm] 469 Replace in pairs only Required quantity 2 reinforced version</p>			

**References**

Audi 4F0 407 151

Audi (FAW) 4F0 407 151

Audi (FAW) L4F0 407 151 A

Audi 4F0 407 151 A

Audi (FAW) 4F0 407 151 A

**Application info**

Audi A6 III (4F2, 4FH, 4F5) (04/04-08/11)

**Control arm****116 050 0044/HD****MCA0155HD****Notes**

Aluminium  
Carbon Neutral  
Control Arm  
Front Axle Left  
Lower  
Rear  
with accessories  
with rubber mount



Article number of recommended accessories 100 654 0023  
Length [mm] 392  
Paired article number 116 050 0064/HD | MCA0162HD  
Replace in pairs only  
Required quantity 1  
reinforced version

**References**

Audi 4F0 407 693

Audi 4F0 407 693 C

Audi 4F0 407 693 H

Audi (FAW) 4F0 407 693

Audi (FAW) 4F0 407 693 C

Audi (FAW) 4F0 407 693 H

Audi 4F0 407 693 B

Audi 4F0 407 693 G

Audi 4F0 407 693 J



Audi (FAW) 4F0 407 693 B

Audi (FAW) 4F0 407 693 G

Audi (FAW) L 4FD 407 693

**Application info**

Audi A6 III (4F2, 4FH, 4F5) (04/04-08/11)

Control arm		116 050 0048/HD	MCA0156HD
<b>Notes</b>			
	Aluminium Carbon Neutral Control Arm Front Axle Left Lower Rear with accessories with rubber mount		
Length [mm]	383		
Paired article number	116 050 0073/HD   MCA0168HD		
Replace in pairs only			
Required quantity reinforced version	1		
<b>References</b>			
Audi 8E0 407 693 AA		Audi 8E0 407 693 AC	
Audi 8E0 407 693 AJ		Audi 8E0 407 693 AK	
Audi 8E0 407 693 AL		Audi 8E0 407 693 AM	
Audi 8E0 407 693 N		Audi 8E0 407 693 T	
Audi (FAW) 8E0 407 693 AL		Seat 8E0 407 693 AL	
Volkswagen (SVW) 8E0 407 693 AA		Volkswagen (SVW) 8E0 407 693 AK	
Volkswagen (SVW) 8E0 407 693 AL		Volkswagen (SVW) 8E0 407 693 T	
<b>Application info</b>			
Audi A4 Cabriolet (8H_) (01/02-12/09)		Audi A4 III (8E_) (11/04-06/08)	
Seat Exeo (3R) (12/08-05/13)			
Control arm		116 050 0049	MCA0157
<b>Notes</b>			
	Cast Steel Control Arm Front Axle Left Lower with ball joint with rubber mount		
Paired article number	116 050 0071   MCA0166		
Required quantity	1		
replacement in pairs recommended			

**References**

Audi 7L8 407 151 B  
 Porsche 955 341 017 31  
 Porsche 955 341 017 33  
 Volkswagen 7L0 407 151 E

Porsche 955 341 017 30  
 Porsche 955 341 017 32  
 Volkswagen 7L0 407 151 C  
 Volkswagen 7L0 407 151 H

**Application info**

Audi Q7 I (4L\_) (03/06-01/16)  
 Volkswagen Touareg I (7LA, 7L6 ,7L7 ) (10/02-01/13)

Porsche Cayenne I (955) (09/02-12/10)

**Control arm**

116 050 0049/S

MCA1103

**Notes**

Cast Steel  
 Control Arm  
 Front Axle Left  
 Lower  
 with ball joint  
 with fastening material  
 with rubber mount

Paired article number  
 Required quantity  
 replacement in pairs recommended

116 050 0071/S | MCA1104  
 1



**References**



Audi 7L8 407 151 B  
 Porsche 955 341 017 32  
 Volkswagen 7L0 407 151 C  
 Volkswagen 7L0 407 151 H

Porsche 955 341 017 30  
 Porsche 955 341 017 33  
 Volkswagen 7L0 407 151 E

**Application info**

Porsche Cayenne I (955) (09/02-12/10)

Volkswagen Touareg I (7LA, 7L6 ,7L7 ) (10/02-01/13)

Control arm		116 050 0063/HD	MCA0161HD
<b>Notes</b>			
	Aluminium		
	Carbon Neutral		
	Control Arm		
	Front		
	Front Axle Right		
	Upper		
	with accessories		
	with rubber mount		
Length [mm]	301		
Paired article number	116 050 0042/HD   MCA0153HD		
Replace in pairs only			
Required quantity	1		
reinforced version			
<b>References</b>			
Audi 4E0 407 506 B		Audi 4E0 407 506 E	
Audi 4E0 407 506 F		Audi (FAW) 4E0 407 506 B	
Audi (FAW) 4E0 407 506 E		Audi (FAW) L4E0 407 506 B	
Volkswagen 4E0 407 506 B		Volkswagen 4E0 407 506 E	
<b>Application info</b>			
Audi A6 III (4F2, 4FH, 4F5) (04/04-08/11)		Audi A8 II (4E_) (10/02-12/10)	
Volkswagen Phaeton (3D) (04/02-03/16)			
Control arm		116 050 0064/HD	MCA0162HD
<b>Notes</b>			
	Aluminium		
	Carbon Neutral		
	Control Arm		
	Front Axle Right		
	Lower		
	Rear		
	with accessories		
	with rubber mount		
Article number of recommended accessory	100 654 0023		
Length [mm]	392		
Paired article number	116 050 0044/HD   MCA0155HD		
Replace in pairs only			
Required quantity	1		
reinforced version			

**References**

Audi 4F0 407 694

Audi 4F0 407 694 C

Audi 4F0 407 694 H

Audi (FAW) 4F0 407 694

Audi (FAW) 4F0 407 694 G

Audi (FAW) L 4FD 407 694

Audi 4F0 407 694 B

Audi 4F0 407 694 G

Audi 4F0 407 694 J

Audi (FAW) 4F0 407 694 B

Audi (FAW) 4F0 407 694 H

**Application info**

Audi A6 III (4F2, 4FH, 4F5) (04/04-08/11)

**Control arm**

116 050 0065/HD

MCA0163HD

**Notes**

Aluminium  
Carbon Neutral  
Control Arm  
Front Axle Left  
Lower  
Rear  
with accessories  
with rubber mount

Length [mm]

397

Paired article number

116 050 0066/HD | MCA0164HD

Replace in pairs only

Required quantity

1

reinforced version

**References**

Audi 4E0 407 693 F

Audi 4E0 407 693 M

Audi 4E0 407 693 R

Volkswagen 4E0 407 693 E

Volkswagen 4E0 407 693 N

Audi 4E0 407 693 L

Audi 4E0 407 693 N

Volkswagen 4E0 407 693 C



Volkswagen 4E0 407 693 F

**Application info**

Audi A8 II (4E\_) (10/02-12/10)

Volkswagen Phaeton (3D) (04/02-03/16)



Control arm		116 050 0066/HD	MCA0164HD										
<p><b>Notes</b></p> <p>Aluminium Carbon Neutral Control Arm Front Axle Right Lower Rear with accessories with rubber mount</p> <p>Length [mm] 397</p> <p>Paired article number 116 050 0065/HD   MCA0163HD</p> <p>Replace in pairs only</p> <p>Required quantity 1</p> <p>reinforced version</p>													
<p><b>References</b></p> <table border="0"> <tr> <td>Audi 4E0 407 694 F</td> <td>Audi 4E0 407 694 L</td> </tr> <tr> <td>Audi 4E0 407 694 M</td> <td>Audi 4E0 407 694 N</td> </tr> <tr> <td>Audi 4E0 407 694 R</td> <td>Volkswagen 4E0 407 694 C</td> </tr> <tr> <td>Volkswagen 4E0 407 694 E</td> <td>Volkswagen 4E0 407 694 F</td> </tr> <tr> <td>Volkswagen 4E0 407 694 N</td> <td></td> </tr> </table>				Audi 4E0 407 694 F	Audi 4E0 407 694 L	Audi 4E0 407 694 M	Audi 4E0 407 694 N	Audi 4E0 407 694 R	Volkswagen 4E0 407 694 C	Volkswagen 4E0 407 694 E	Volkswagen 4E0 407 694 F	Volkswagen 4E0 407 694 N	
Audi 4E0 407 694 F	Audi 4E0 407 694 L												
Audi 4E0 407 694 M	Audi 4E0 407 694 N												
Audi 4E0 407 694 R	Volkswagen 4E0 407 694 C												
Volkswagen 4E0 407 694 E	Volkswagen 4E0 407 694 F												
Volkswagen 4E0 407 694 N													
<p><b>Application info</b></p> <table border="0"> <tr> <td>Audi A8 II (4E_) (10/02-12/10)</td> <td>Volkswagen Phaeton (3D) (04/02-03/16)</td> </tr> </table>				Audi A8 II (4E_) (10/02-12/10)	Volkswagen Phaeton (3D) (04/02-03/16)								
Audi A8 II (4E_) (10/02-12/10)	Volkswagen Phaeton (3D) (04/02-03/16)												
Control arm		116 050 0067/HD	MCA0165HD										
<p><b>Notes</b></p> <p>Aluminium Carbon Neutral Control Arm Front Front Axle Left Front Axle Right Lower with accessories with rubber mount</p> <p>Length [mm] 470</p> <p>Replace in pairs only</p> <p>Required quantity 2</p> <p>reinforced version</p>													

**References**

Audi 4E0 407 151 G

Audi 4E0 407 151 L

**Application info**

Audi A8 II (4E\_) (10/02-12/10)

**Control arm**

116 050 0071

MCA0166

**Notes**

Cast Steel  
Control Arm  
Front Axle Right  
Lower  
with ball joint  
with rubber mount

Paired article number

116 050 0049 | MCA0157

Required quantity

1

replacement in pairs recommended



**References**

Audi 7L8 407 152 B

Porsche 955 341 018 30

Porsche 955 341 018 32

Porsche 955 341 018 33

Volkswagen 7L0 407 152 C

Volkswagen 7L0 407 152 E

Volkswagen 7L0 407 152 H

**Application info**

Audi Q7 I (4L\_) (03/06-01/16)

Porsche Cayenne I (955) (09/02-12/10)

Volkswagen Touareg I (7LA, 7L6 ,7L7 ) (10/02-01/13)

**Control arm**

116 050 0071/S

MCA1104

**Notes**

Cast Steel  
Control Arm  
Front Axle Right  
Lower  
with ball joint  
with fastening material  
with rubber mount

Paired article number

116 050 0049/S | MCA1103

Required quantity

1

replacement in pairs recommended



**References**

Audi 7L8 407 152 B	Porsche 955 341 018 30
Porsche 955 341 018 32	Porsche 955 341 018 33
Volkswagen 7L0 407 152 C	Volkswagen 7L0 407 152 E
Volkswagen 7L0 407 152 H	

**Application info**

Audi Q7 I (4L_) (03/06-01/16)	Porsche Cayenne I (955) (09/02-12/10)
Volkswagen Touareg I (7LA, 7L6 ,7L7 ) (10/02-01/13)	

**Control arm**

116 050 0072/HD

MCA0167HD

**Notes**

Aluminium  
Carbon Neutral  
Control Arm  
Front Axle Left  
Front Axle Right  
with rubber mount

Article number of recommended accessories 100 654 0009  
Paired article number 100 654 0009  
Replace in pairs only  
Required quantity 2  
reinforced version



**References**

Audi 3C0 407 151 G	Audi 3C0 407 151 H
Seat 3C0 407 151 E	Seat 3C0 407 151 G
Seat 3C0 407 151 H	Volkswagen 3C0 407 151 A
Volkswagen 3C0 407 151 B	Volkswagen 3C0 407 151 E
Volkswagen 3C0 407 151 G	Volkswagen 3C0 407 151 H
Volkswagen (FAW) 3C0 407 151 E	

**Application info**

Audi Q3 I (8U_) (06/11-12/18)	Seat Alhambra II (710) (06/10--)
Volkswagen CC (11/11-12/16)	Volkswagen Passat (362, 365) (08/10-12/15)
Volkswagen Passat (3C_) (03/05-01/12)	Volkswagen Sharan (7N) (05/10--)
Volkswagen Tiguan I (5N) (09/07-07/18)	

Control arm		116 050 0073/HD	MCA0168HD
<b>Notes</b>	<p>Aluminium Carbon Neutral Control Arm Front Axle Right Lower Rear with accessories with rubber mount</p>		
<p>Length [mm] Paired article number Replace in pairs only Required quantity reinforced version</p>	<p>383 116 050 0048/HD   MCA0156HD 1</p>		

References	
Audi 8E0 407 694 AA	Audi 8E0 407 694 AC
Audi 8E0 407 694 AJ	Audi 8E0 407 694 AK
Audi 8E0 407 694 AL	Audi 8E0 407 694 AM
Audi 8E0 407 694 N	Audi 8E0 407 694 T
Audi (FAW) 8E0 407 694 AL	Seat 8E0 407 694 AL
Volkswagen (SVW) 8E0 407 694 AA	Volkswagen (SVW) 8E0 407 694 AK
Volkswagen (SVW) 8E0 407 694 AL	Volkswagen (SVW) 8E0 407 694 T

Application info	
Audi A4 Cabriolet (8H_) (01/02-12/09)	Audi A4 III (8E_) (11/04-06/08)
Seat Exeo (3R) (12/08-05/13)	

Control arm		116 050 0076/HD	MCA0169HD
<b>Notes</b>	<p>Carbon Neutral Control Arm Front Axle Left Lower Steel with rubber mount</p>		
<p>Article number of recommended accessori Paired article number Replace in pairs only Required quantity reinforced version</p>	<p>100 654 0019 116 050 0077/HD   MCA0170HD 1</p>		

**References**

Volkswagen 7H0 407 151 E  
 Volkswagen 7H0 407 151 G

Volkswagen 7H0 407 151 F  
 Volkswagen 7H8 407 151 B

**Application info**

Volkswagen Transporter V (04/03-08/15)

**Control arm**

116 050 0077/HD

MCA0170HD

**Notes**

Carbon Neutral  
 Control Arm  
 Front Axle Right  
 Lower  
 Steel  
 with rubber mount

Article number of recommended accessory 100 654 0019  
 Paired article number 116 050 0076/HD | MCA0169HD  
 Replace in pairs only  
 Required quantity 1  
 reinforced version



**References**

Volkswagen 7H0 407 152 E  
 Volkswagen 7H0 407 152 G

Volkswagen 7H0 407 152 F  
 Volkswagen 7H8 407 152 B

**Application info**

Volkswagen Transporter V (04/03-08/15)

**Control arm**

116 050 0079

MCA0172

**Notes**

Control Arm  
 Lower  
 Rear Axle Left  
 Rear Axle Right  
 Sheet Steel  
 with rubber mount

Required quantity 2  
 replacement in pairs recommended



**References**

Audi 1K0 505 311 AB  
 Seat 1K0 505 311 AA  
 Skoda 1K0 505 311 AB  
 Volkswagen 1K0 505 311 AA  
 Volkswagen 1K0 505 311 H  
 Volkswagen 1K0 505 311 R  
 Volkswagen 1K0 505 311 T

Audi (FAW) 1K0 505 311 AB  
 Seat 1K0 505 311 AB  
 Skoda 1K0 505 311 S  
 Volkswagen 1K0 505 311 AB  
 Volkswagen 1K0 505 311 J  
 Volkswagen 1K0 505 311 S  
 Volkswagen 1K0 506 311 S

**Application info**

Audi A1 I (8X\_) (05/10-10/18)  
 Audi Q3 I (8U\_) (06/11-12/18)  
 Seat Leon II / Toledo III / Altea (1P\_ ,5P\_) (03/04--)  
 Skoda Superb II (3T) (03/08-05/15)  
 Volkswagen Beetle (5C1) (04/11-07/19)  
 Volkswagen Eos (03/06-08/15)  
 Volkswagen Golf VI (5K1, 517, AJ5) (10/08-05/16)  
 Volkswagen Jetta IV (162) (01/08--)  
 Volkswagen Passat (3C\_) (03/05-01/12)  
 Volkswagen Scirocco III (137) (05/08-11/17)  
 Volkswagen Touran I (1T1/2/3) (02/03-05/15)

Audi A3 II (8P\_) (05/03-12/15)  
 Audi TT II (8J\_) (07/06-01/15)  
 Skoda Octavia II (1Z\_) (02/04-06/13)  
 Skoda Yeti (5L) (05/09-12/17)  
 Volkswagen CC (11/11-12/16)  
 Volkswagen Golf V (1K1, 1K5, 5M1) (10/03-08/14)  
 Volkswagen Jetta III (1K2) (09/04-12/13)  
 Volkswagen Passat (362, 365) (08/10-12/15)  
 Volkswagen Passat (A32) (01/11--)  
 Volkswagen Tiguan I (5N) (09/07-07/18)

**Control arm****116 050 0079/S****MCA0800****Notes**

Control Arm  
 Lower  
 Rear Axle Left  
 Rear Axle Right  
 Sheet Steel  
 with accessories  
 with rubber mount

Required quantity  
 replacement in pairs recommended

2

**References**

Audi 1K0 505 311 AB  
 Seat 1K0 505 311 AA  
 Skoda 1K0 505 311 AB  
 Volkswagen 1K0 505 311 AA  
 Volkswagen 1K0 505 311 H  
 Volkswagen 1K0 505 311 R  
 Volkswagen 1K0 505 311 T

Audi (FAW) 1K0 505 311 AB  
 Seat 1K0 505 311 AB  
 Skoda 1K0 505 311 S  
 Volkswagen 1K0 505 311 AB  
 Volkswagen 1K0 505 311 J  
 Volkswagen 1K0 505 311 S  
 Volkswagen 1K0 506 311 S

**Application info**

Audi A1 I (8X_) (05/10-10/18)	Audi A3 II (8P_) (05/03-12/15)
Audi Q3 I (8U_) (06/11-12/18)	Audi TT II (8J_) (07/06-01/15)
Seat Leon II / Toledo III / Altea (1P_ ,5P_) (03/04--)	Skoda Octavia II (1Z_) (02/04-06/13)
Skoda Superb II (3T) (03/08-05/15)	Skoda Yeti (5L) (05/09-12/17)
Volkswagen Beetle (5C1) (04/11-07/19)	Volkswagen CC (11/11-12/16)
Volkswagen Eos (03/06-08/15)	Volkswagen Golf V (1K1, 1K5, 5M1) (10/03-08/14)
Volkswagen Golf VI (5K1, 517, AJ5) (10/08-05/16)	Volkswagen Jetta III (1K2) (09/04-12/13)
Volkswagen Jetta IV (162) (01/08--)	Volkswagen Passat (362, 365) (08/10-12/15)
Volkswagen Passat (3C_) (03/05-01/12)	Volkswagen Passat (A32) (01/11--)
Volkswagen Scirocco III (137) (05/08-11/17)	Volkswagen Tiguan I (5N ) (09/07-07/18)
Volkswagen Touran I ( 1T1/2/3) (02/03-05/15)	

**Control arm****116 050 0080/HD****MCA0173HD****Notes**

Carbon Neutral  
 Front  
 Rear Axle Left  
 Sheet Steel  
 Trailing Arm  
 with fastening material  
 with rubber mount

Article number of recommended accessories	100 754 0005
Paired article number	116 050 0081/HD   MCA0174HD
Replace in pairs only	
Required quantity	1
reinforced version	

**References**

Audi 1K0 505 223 K	Seat 1K0 505 223 E
Seat 1K0 505 223 K	Skoda 1K0 505 223 E
Skoda 1K0 505 223 H	Skoda 1K0 505 223 K
Volkswagen 1K0 505 223 E	Volkswagen 1K0 505 223 F
Volkswagen 1K0 505 223 H	Volkswagen 1K0 505 223 K
Volkswagen 1T0 505 223 F	

**Application info**

- |  |  |
|--|--|
| Audi A1 I (8X_) (05/10-10/18)                    | Audi A3 II (8P_) (05/03-12/15)                         |
| Audi TT II (8J_) (07/06-01/15)                   | Seat Leon II / Toledo III / Altea (1P_ ,5P_) (03/04--) |
| Skoda Octavia II (1Z_) (02/04-06/13)             | Skoda Superb II (3T) (03/08-05/15)                     |
| Skoda Yeti (5L) (05/09-12/17)                    | Volkswagen Beetle (5C1) (04/11-07/19)                  |
| Volkswagen Eos (03/06-08/15)                     | Volkswagen Golf V (1K1, 1K5, 5M1) (10/03-08/14)        |
| Volkswagen Golf VI (5K1, 517, AJ5) (10/08-05/16) | Volkswagen Jetta III (1K2) (09/04-12/13)               |
| Volkswagen Jetta IV (162) (01/08--)              | Volkswagen Passat (A32) (01/11--)                      |
| Volkswagen Scirocco III (137) (05/08-11/17)      | Volkswagen Touran I ( 1T1/2/3) (02/03-05/15)           |

**Control arm**

116 050 0080

MCA0173

**Notes**

Front  
 Rear Axle Left  
 Sheet Steel  
 Trailing Arm  
 with rubber mount  
 Paired article number 116 050 0081 | MCA0174  
 Required quantity 1

replacement in pairs recommended



**References**

- |                          |                          |
|--------------------------|--------------------------|
| Audi 1K0 505 223 K       | Seat 1K0 505 223 E       |
| Seat 1K0 505 223 K       | Skoda 1K0 505 223 E      |
| Skoda 1K0 505 223 H      | Skoda 1K0 505 223 K      |
| Volkswagen 1K0 505 223 E | Volkswagen 1K0 505 223 F |
| Volkswagen 1K0 505 223 H | Volkswagen 1K0 505 223 K |
| Volkswagen 1T0 505 223 F |                          |

**Application info**

- |  |  |
|--|--|
| Audi A1 I (8X_) (05/10-10/18)                    | Audi A3 II (8P_) (05/03-12/15)                         |
| Audi TT II (8J_) (07/06-01/15)                   | Seat Leon II / Toledo III / Altea (1P_ ,5P_) (03/04--) |
| Skoda Octavia II (1Z_) (02/04-06/13)             | Skoda Superb II (3T) (03/08-05/15)                     |
| Skoda Yeti (5L) (05/09-12/17)                    | Volkswagen Beetle (5C1) (04/11-07/19)                  |
| Volkswagen Eos (03/06-08/15)                     | Volkswagen Golf V (1K1, 1K5, 5M1) (10/03-08/14)        |
| Volkswagen Golf VI (5K1, 517, AJ5) (10/08-05/16) | Volkswagen Jetta III (1K2) (09/04-12/13)               |
| Volkswagen Jetta IV (162) (01/08--)              | Volkswagen Passat (A32) (01/11--)                      |
| Volkswagen Scirocco III (137) (05/08-11/17)      | Volkswagen Touran I ( 1T1/2/3) (02/03-05/15)           |



## Control arm

116 050 0081

MCA0174

## Notes

Front  
Rear Axle Right  
Sheet Steel  
Trailing Arm  
with rubber mount  
Paired article number 116 050 0080 | MCA0173  
Required quantity 1  
replacement in pairs recommended



## References

Audi 1K0 505 224 K	Seat 1K0 505 224 E
Seat 1K0 505 224 K	Skoda 1K0 505 224 E
Skoda 1K0 505 224 H	Skoda 1K0 505 224 K
Volkswagen 1K0 505 224 E	Volkswagen 1K0 505 224 F
Volkswagen 1K0 505 224 H	Volkswagen 1K0 505 224 K
Volkswagen 1T0 505 224 F	

## Application info

Audi A1 I (8X_) (05/10-10/18)	Audi A3 II (8P_) (05/03-12/15)
Audi TT II (8J_) (07/06-01/15)	Seat Leon II / Toledo III / Altea (1P_ ,5P_) (03/04--)
Skoda Octavia II (1Z_) (02/04-06/13)	Skoda Superb II (3T) (03/08-05/15)
Skoda Yeti (5L) (05/09-12/17)	Volkswagen Beetle (5C1) (04/11-07/19)
Volkswagen Eos (03/06-08/15)	Volkswagen Golf V (1K1, 1K5, 5M1) (10/03-08/14)
Volkswagen Golf VI (5K1, 517, AJ5) (10/08-05/16)	Volkswagen Jetta III (1K2) (09/04-12/13)
Volkswagen Jetta IV (162) (01/08--)	Volkswagen Passat (A32) (01/11--)
Volkswagen Scirocco III (137) (05/08-11/17)	Volkswagen Touran I ( 1T1/2/3) (02/03-05/15)

## Control arm

116 050 0081/HD

MCA0174HD

## Notes

Carbon Neutral  
 Front  
 Rear Axle Right  
 Sheet Steel  
 Trailing Arm  
 with fastening material  
 with rubber mount







Article number of recommended accessories 100 754 0005  
 Paired article number 116 050 0080/HD | MCA0173HD  
 Replace in pairs only  
 Required quantity 1  
 reinforced version

## References

Audi 1K0 505 224 K	Seat 1K0 505 224 E
Seat 1K0 505 224 K	Skoda 1K0 505 224 E
Skoda 1K0 505 224 H	Skoda 1K0 505 224 K
Volkswagen 1K0 505 224 E	Volkswagen 1K0 505 224 F
Volkswagen 1K0 505 224 H	Volkswagen 1K0 505 224 K
Volkswagen 1T0 505 224 F	

## Application info

Audi A1 I (8X_) (05/10-10/18)	Audi A3 II (8P_) (05/03-12/15)
Audi TT II (8J_) (07/06-01/15)	Seat Leon II / Toledo III / Altea (1P_ ,5P_) (03/04--)
Skoda Octavia II (1Z_) (02/04-06/13)	Skoda Superb II (3T) (03/08-05/15)
Skoda Yeti (5L) (05/09-12/17)	Volkswagen Beetle (5C1) (04/11-07/19)
Volkswagen Eos (03/06-08/15)	Volkswagen Golf V (1K1, 1K5, 5M1) (10/03-08/14)
Volkswagen Golf VI (5K1, 517, AJ5) (10/08-05/16)	Volkswagen Jetta III (1K2) (09/04-12/13)
Volkswagen Jetta IV (162) (01/08--)	Volkswagen Passat (A32) (01/11--)
Volkswagen Scirocco III (137) (05/08-11/17)	Volkswagen Touran I (1T1/2/3) (02/03-05/15)

Control arm		116 050 0090	MCA0177
<p><b>Notes</b></p> <p>Control Arm Front Axle Right Sheet Steel with ball joint with rubber mount</p> <p>Paired article number 116 050 0091   MCA0178 Required quantity 1 replacement in pairs recommended</p>		 	
<p><b>References</b></p> <p>Mercedes-Benz 906 330 41 07 Mercedes-Benz 906 330 47 07 Mercedes-Benz A 906 330 41 07 Mercedes-Benz A 906 330 47 07 Volkswagen 2E0 407 152 L Volkswagen 2E0 407 152 M</p>			
<p><b>Application info</b></p> <p>Mercedes-Benz BM 906 (Sprinter II) (06/06--) Volkswagen Crafter I (2E) (04/06-12/16)</p> <p>Mercedes-Benz BM 907 / 910 (Sprinter III) (02/18--)</p>			
Control arm		116 050 0091	MCA0178
<p><b>Notes</b></p> <p>Control Arm Front Axle Left Sheet Steel with ball joint with rubber mount</p> <p>Paired article number 116 050 0090   MCA0177 Required quantity 1 replacement in pairs recommended</p>		 	
<p><b>References</b></p> <p>Mercedes-Benz 906 330 40 07 Mercedes-Benz 906 330 46 07 Mercedes-Benz A 906 330 40 07 Mercedes-Benz A 906 330 46 07 Volkswagen 2E0 407 151 L Volkswagen 2E0 407 151 M</p>			
<p><b>Application info</b></p> <p>Mercedes-Benz BM 906 (Sprinter II) (06/06--) Volkswagen Crafter I (2E) (04/06-12/16)</p> <p>Mercedes-Benz BM 907 / 910 (Sprinter III) (02/18--)</p>			

**Control arm**

116 050 0093

MCA0180

**Notes**

Control Arm  
 Front Axle Left  
 Sheet Steel  
 with rubber mount  
 without ball joint  
 Paired article number 116 050 0094 | MCA0181  
 Required quantity 1  
 replacement in pairs recommended



**References**

Seat 6R0 407 151	Seat 6R0 407 151 E
Skoda 6R0 407 151	Skoda 6R0 407 151 E
Volkswagen 6R0 407 151	Volkswagen 6R0 407 151 E

**Application info**

Seat Ibiza III / Cordoba II (6L_) (02/02-11/09)	Skoda Fabia II (54_) (12/06-12/14)
Skoda Roomster (03/06-05/15)	Volkswagen Polo (9N_) (10/01--)

**Control arm**

116 050 0094

MCA0181

**Notes**

Control Arm  
 Front Axle Right  
 Sheet Steel  
 with rubber mount  
 without ball joint  
 Paired article number 116 050 0093 | MCA0180  
 Required quantity 1  
 replacement in pairs recommended





**References**

Seat 6R0 407 152	Seat 6R0 407 152 E
Skoda 6R0 407 152	Skoda 6R0 407 152 E
Volkswagen 6R0 407 152	Volkswagen 6R0 407 152 E

**Application info**

Seat Ibiza III / Cordoba II (6L_) (02/02-11/09)	Skoda Fabia II (54_) (12/06-12/14)
Skoda Roomster (03/06-05/15)	Volkswagen Polo (9N_) (10/01--)

Control arm		116 050 0096	MCA0182																
<p><b>Notes</b></p> <p>Aluminium Control Arm Front Axle Left Lower with ball joint with rubber mount</p> <p>Paired article number 116 050 0097   MCA0183</p> <p>Required quantity 1</p> <p>replacement in pairs recommended</p>																			
<p><b>References</b></p> <table border="0"> <tr> <td>Audi 7L8 407 151 F</td> <td>Audi 7L8 407 151 K</td> </tr> <tr> <td>Audi 7P0 407 151 B</td> <td>Audi 7P0 407 151 C</td> </tr> <tr> <td>Audi 7P0 407 151 D</td> <td>Audi 7P0 407 151 E</td> </tr> <tr> <td>Porsche 958 341 053 00</td> <td>Porsche 958 341 053 01</td> </tr> <tr> <td>Porsche 958 341 053 02</td> <td>Porsche 958 341 053 03</td> </tr> <tr> <td>Volkswagen 7L8 407 151 F</td> <td>Volkswagen 7P0 407 151 B</td> </tr> <tr> <td>Volkswagen 7P0 407 151 C</td> <td>Volkswagen 7P0 407 151 D</td> </tr> <tr> <td>Volkswagen 7P0 407 151 E</td> <td></td> </tr> </table>				Audi 7L8 407 151 F	Audi 7L8 407 151 K	Audi 7P0 407 151 B	Audi 7P0 407 151 C	Audi 7P0 407 151 D	Audi 7P0 407 151 E	Porsche 958 341 053 00	Porsche 958 341 053 01	Porsche 958 341 053 02	Porsche 958 341 053 03	Volkswagen 7L8 407 151 F	Volkswagen 7P0 407 151 B	Volkswagen 7P0 407 151 C	Volkswagen 7P0 407 151 D	Volkswagen 7P0 407 151 E	
Audi 7L8 407 151 F	Audi 7L8 407 151 K																		
Audi 7P0 407 151 B	Audi 7P0 407 151 C																		
Audi 7P0 407 151 D	Audi 7P0 407 151 E																		
Porsche 958 341 053 00	Porsche 958 341 053 01																		
Porsche 958 341 053 02	Porsche 958 341 053 03																		
Volkswagen 7L8 407 151 F	Volkswagen 7P0 407 151 B																		
Volkswagen 7P0 407 151 C	Volkswagen 7P0 407 151 D																		
Volkswagen 7P0 407 151 E																			
<p><b>Application info</b></p> <table border="0"> <tr> <td>Audi Q7 I (4L_) (03/06-01/16)</td> <td>Porsche Cayenne II (92A) (06/10--)</td> </tr> <tr> <td>Volkswagen Touareg II (7P5) (01/10-12/18)</td> <td></td> </tr> </table>				Audi Q7 I (4L_) (03/06-01/16)	Porsche Cayenne II (92A) (06/10--)	Volkswagen Touareg II (7P5) (01/10-12/18)													
Audi Q7 I (4L_) (03/06-01/16)	Porsche Cayenne II (92A) (06/10--)																		
Volkswagen Touareg II (7P5) (01/10-12/18)																			
Control arm		116 050 0096/S	MCA1000																
<p><b>Notes</b></p> <p>Aluminium Control Arm Front Axle Left Lower with accessories with ball joint with rubber mount</p> <p>Paired article number 116 050 0097/S   MCA1001</p> <p>Required quantity 1</p> <p>replacement in pairs recommended</p>																			

**References**

- |                          |                          |
|--------------------------|--------------------------|
| Audi 7L8 407 151 F       | Audi 7L8 407 151 K       |
| Audi 7P0 407 151 B       | Audi 7P0 407 151 C       |
| Audi 7P0 407 151 D       | Audi 7P0 407 151 E       |
| Porsche 958 341 053 00   | Porsche 958 341 053 01   |
| Porsche 958 341 053 02   | Porsche 958 341 053 03   |
| Volkswagen 7L8 407 151 F | Volkswagen 7P0 407 151 B |
| Volkswagen 7P0 407 151 C | Volkswagen 7P0 407 151 D |
| Volkswagen 7P0 407 151 E |                          |

**Application info**

- |   |                                    |
|---|------------------------------------|
| Audi Q7 I (4L_) (03/06-01/16)             | Porsche Cayenne II (92A) (06/10--) |
| Volkswagen Touareg II (7P5) (01/10-12/18) |                                    |

**Control arm**

116 050 0097

MCA0183

**Notes**

Aluminium  
Control Arm  
Front Axle Right  
Lower  
with ball joint  
with rubber mount

Paired article number 116 050 0096 | MCA0182  
Required quantity 1  
replacement in pairs recommended



**References**

- |                          |                          |
|--------------------------|--------------------------|
| Audi 7L8 407 152 F       | Audi 7L8 407 152 K       |
| Audi 7P0 407 152 B       | Audi 7P0 407 152 C       |
| Audi 7P0 407 152 D       | Audi 7P0 407 152 E       |
| Porsche 958 341 054 00   | Porsche 958 341 054 01   |
| Porsche 958 341 054 02   | Porsche 958 341 054 03   |
| Volkswagen 7L8 407 152 F | Volkswagen 7P0 407 152 B |
| Volkswagen 7P0 407 152 C | Volkswagen 7P0 407 152 D |
| Volkswagen 7P0 407 152 E |                          |

**Application info**

- |   |                                    |
|---|------------------------------------|
| Audi Q7 I (4L_) (03/06-01/16)             | Porsche Cayenne II (92A) (06/10--) |
| Volkswagen Touareg II (7P5) (01/10-12/18) |                                    |

**Control arm**

116 050 0097/S

MCA1001

**Notes**

Aluminium  
Control Arm  
Front Axle Right  
Lower  
with accessories  
with ball joint  
with rubber mount

Paired article number 116 050 0096/S | MCA1000  
Required quantity 1  
replacement in pairs recommended



**References**

- |                          |                          |
|--------------------------|--------------------------|
| Audi 7L8 407 152 F       | Audi 7L8 407 152 K       |
| Audi 7P0 407 152 B       | Audi 7P0 407 152 C       |
| Audi 7P0 407 152 D       | Audi 7P0 407 152 E       |
| Porsche 958 341 054 00   | Porsche 958 341 054 01   |
| Porsche 958 341 054 02   | Porsche 958 341 054 03   |
| Volkswagen 7L8 407 152 F | Volkswagen 7P0 407 152 B |
| Volkswagen 7P0 407 152 C | Volkswagen 7P0 407 152 D |
| Volkswagen 7P0 407 152 E |                          |

**Application info**

- |   |                                    |
|---|------------------------------------|
| Audi Q7 I (4L_) (03/06-01/16)             | Porsche Cayenne II (92A) (06/10--) |
| Volkswagen Touareg II (7P5) (01/10-12/18) |                                    |

**Control arm**

116 050 0098

MCA0184

**Notes**

Cast Steel  
Control Arm  
Front Axle Left  
with ball joint  
with rubber mount

Paired article number 116 050 0099 | MCA0185  
Paired article number 116 050 0099/S  
Required quantity 1  
Thread Size M12x1,5  
replacement in pairs recommended



**References**

- Audi 8Z0 407 151 J

**Application info**

Audi A2 (8Z0) (02/00-08/05)

**Control arm**

116 050 0099

MCA0185

**Notes**

Cast Steel  
Control Arm  
Front Axle Right  
with ball joint  
with rubber mount

Paired article number 116 050 0098 | MCA0184  
Required quantity 1  
Thread Size M12x1,5  
replacement in pairs recommended

**References**

Audi 8Z0 407 152 J

**Application info**

Audi A2 (8Z0) (02/00-08/05)

**Control arm**

116 050 0101

MCA0870

**Notes**

Aluminium  
Control Arm  
Front Axle Left  
Front Axle Right  
Upper  
with ball joint  
with rubber mount

Required quantity 2  
replacement in pairs recommended

**References**

Audi 7L8 407 021

**Application info**

Audi Q7 I (4L\_) (03/06-01/16)



**Control arm**

116 050 0101/S

MCA0984

**Notes**

Aluminium  
Control Arm  
Front Axle Left  
Front Axle Right  
Upper  
with accessories  
with ball joint  
with rubber mount

Required quantity  
replacement in pairs recommended

**References**

Audi 7L8 407 021

**Application info**

Audi Q7 I (4L\_) (03/06-01/16)

**Control arm**

116 050 0103/HD

MCA0188HD

**Notes**

Carbon Neutral  
Control Arm  
Front Axle Left  
Sheet Steel  
with rubber mount  
without ball joint

Paired article number  
Replace in pairs only  
Required quantity  
reinforced version

116 050 0104/HD | MCA0189HD

**References**

Audi 6R0 407 151 B

Seat 6R0 407 151 A

Seat 6R0 407 151 C

Skoda 6R0 407 151 F

Volkswagen 6R0 407 151 F

Audi 6R0 407 151 F

Seat 6R0 407 151 B

Seat 6R0 407 151 F

Volkswagen 6R0 407 151 A

**Application info**

Audi A1 I (8X\_) (05/10-10/18)





Skoda Fabia III (NJ\_) (08/14--)

Volkswagen Polo (6R\_) (03/09--)

Seat Ibiza IV (6J\_ ,6P\_) (03/08-12/18)

Skoda Rapid II (N\_) (07/12-12/19)

Volkswagen Polo Vivo (6R1, 6RS) (07/17--)

Control arm		116 050 0104/HD	MCA0189HD
<b>Notes</b>  Carbon Neutral Control Arm Front Axle Right Sheet Steel with rubber mount without ball joint  Paired article number Replace in pairs only Required quantity reinforced version		 	
<b>References</b> Audi 6R0 407 152 B Seat 6R0 407 152 A Seat 6R0 407 152 C Skoda 6R0 407 152 F Volkswagen 6R0 407 152 F		Audi 6R0 407 152 F Seat 6R0 407 152 B Seat 6R0 407 152 F Volkswagen 6R0 407 152 A	
<b>Application info</b> Audi A1 I (8X_) (05/10-10/18) Skoda Fabia III (NJ_) (08/14--) Volkswagen Polo (6R_) (03/09--)  Seat Ibiza IV (6J_ ,6P_) (03/08-12/18) Skoda Rapid II (N_) (07/12-12/19) Volkswagen Polo Vivo (6R1, 6RS) (07/17--)  <b>References</b> Audi 7L0 505 311 B Porsche 955 331 017 12 Volkswagen 7P0 505 311 E		Seat Ibiza IV (6J_ ,6P_) (03/08-12/18) Skoda Rapid II (N_) (07/12-12/19) Volkswagen Polo Vivo (6R1, 6RS) (07/17--)  Porsche 955 331 017 11 Volkswagen 7L0 505 311 B	
Control arm		116 050 0105	MCA0946
<b>Notes</b>  Control Arm Lower Rear Axle Left Sheet Steel with rubber mount  Paired article number Required quantity replacement in pairs recommended		 	
<b>References</b> Audi 7L0 505 311 B Porsche 955 331 017 12 Volkswagen 7P0 505 311 E		Porsche 955 331 017 11 Volkswagen 7L0 505 311 B	

**Application info**

Audi Q7 I (4L\_) (03/06-01/16)

Volkswagen Touareg I (7LA, 7L6 ,7L7 ) (10/02-01/13)

Porsche Cayenne I (955) (09/02-12/10)

Volkswagen Touareg II (7P5 ) (01/10-12/18)

**Control arm**

116 050 0106

MCA0947

**Notes**

Control Arm  
Lower  
Rear Axle Right  
Sheet Steel  
with rubber mount

Paired article number

116 050 0105 | MCA0946

Required quantity

1

replacement in pairs recommended



**References**

Audi 7L0 505 312 B

Porsche 955 331 018 12

Volkswagen 7P0 505 312 E

Porsche 955 331 018 11

Volkswagen 7L0 505 312 B

**Application info**

Audi Q7 I (4L\_) (03/06-01/16)

Volkswagen Touareg I (7LA, 7L6 ,7L7 ) (10/02-01/13)

Porsche Cayenne I (955) (09/02-12/10)

Volkswagen Touareg II (7P5 ) (01/10-12/18)

**Control arm**

116 050 0107

MCA0948

**Notes**

Control Arm  
Front Axle Left  
Lower  
Sheet Steel  
with ball joint  
with rubber mount

Paired article number

116 050 0108 | MCA0949

Required quantity

1

replacement in pairs recommended



**References**

Volkswagen 2H0 407 151 A

**Application info**

Volkswagen Amarok I (09/10--)

**Control arm** 116 050 0108 MCA0949

**Notes**

Control Arm  
 Front Axle Right  
 Lower  
 Sheet Steel  
 with ball joint  
 with rubber mount

Paired article number  
 Required quantity  
 replacement in pairs recommended

116 050 0107 | MCA0948  
 1



**References**

Volkswagen 2H0 407 152 A

**Application info**

Volkswagen Amarok I (09/10--)

**Control arm** 116 050 0109/S MCA1011

**Notes**

Control Arm  
 Front Axle Left  
 Sheet Steel  
 Upper  
 with accessories  
 with ball joint  
 with rubber mount

Paired article number  
 Required quantity  
 replacement in pairs recommended

116 050 0110/S | MCA1012  
 1









**References**





Volkswagen 2H0 407 021 B

**Application info**

Volkswagen Amarok I (09/10--)

Control arm		116 050 0110/S	MCA1012
<p><b>Notes</b></p> <p>Control Arm Front Axle Right Sheet Steel Upper with accessories with ball joint with rubber mount</p> <p>Paired article number Required quantity replacement in pairs recommended</p>	<p>Control Arm Front Axle Right Sheet Steel Upper with accessories with ball joint with rubber mount</p> <p>116 050 0109/S   MCA1011</p> <p>1</p>		
<p><b>References</b></p> <p>Volkswagen 2H0 407 022 B</p>			
<p><b>Application info</b></p> <p>Volkswagen Amarok I (09/10--)</p>			
Control arm		116 050 0114	MCA0192
<p><b>Notes</b></p> <p>Control Arm Front Axle Left Sheet Steel with rubber mount without ball joint</p> <p>Paired article number Required quantity replacement in pairs recommended</p>	<p>Control Arm Front Axle Left Sheet Steel with rubber mount without ball joint</p> <p>116 050 0115   MCA0193</p> <p>1</p>		
<p><b>References</b></p> <p>Seat 1S0 407 151 Volkswagen 1S0 407 151</p> <p>Skoda 1S0 407 151</p>			
<p><b>Application info</b></p> <p>Seat Mii (10/11--) Volkswagen UP (08/11--)</p> <p>Skoda Citigo (10/11--)</p>			

Control arm		116 050 0115	MCA0193
<b>Notes</b>  Control Arm Front Axle Right Sheet Steel with rubber mount without ball joint  Paired article number 116 050 0114   MCA0192 Required quantity 1 replacement in pairs recommended		 	
<b>References</b> Seat 1S0 407 152 Skoda 1S0 407 152 Volkswagen 1S0 407 152			
<b>Application info</b> Seat Mii (10/11--) Volkswagen UP (08/11--) Skoda Citigo (10/11--)			
Control arm		116 050 0116	MCA0874
<b>Notes</b>  Control Arm Front Axle Left Sheet Steel with rubber mount without ball joint  Article number of recommended accessories 100 654 0015 Paired article number 116 050 0117   MCA0875 Required quantity 1 replacement in pairs recommended		 	
<b>References</b> Skoda 1K0 407 151 BB Skoda 1K0 407 151 BE Skoda 1K0 407 151 BG Skoda 1K0 407 151 BL Volkswagen 1K0 407 151 BB Volkswagen 1K0 407 151 BE Volkswagen 1K0 407 151 BG Volkswagen 1K0 407 151 BL			
<b>Application info</b> Skoda Octavia II (1Z_) (02/04-06/13) Skoda Yeti (5L) (05/09-12/17) Volkswagen Caddy IV (SA_) (05/15--) Skoda Superb II (3T) (03/08-05/15) Volkswagen Caddy III (2KA, 2KB) (03/04-05/15)			

Control arm		116 050 0117	MCA0875								
<p><b>Notes</b></p> <p>Control Arm Front Axle Right Sheet Steel with rubber mount without ball joint</p> <p>Article number of recommended accessory: 100 654 0015 Paired article number: 116 050 0116   MCA0874 Required quantity: 1 replacement in pairs recommended</p>		 									
<p><b>References</b></p> <table border="0"> <tr> <td>Skoda 1K0 407 152 BB</td> <td>Skoda 1K0 407 152 BE</td> </tr> <tr> <td>Skoda 1K0 407 152 BG</td> <td>Skoda 1K0 407 152 BL</td> </tr> <tr> <td>Volkswagen 1K0 407 152 BB</td> <td>Volkswagen 1K0 407 152 BE</td> </tr> <tr> <td>Volkswagen 1K0 407 152 BG</td> <td>Volkswagen 1K0 407 152 BL</td> </tr> </table>				Skoda 1K0 407 152 BB	Skoda 1K0 407 152 BE	Skoda 1K0 407 152 BG	Skoda 1K0 407 152 BL	Volkswagen 1K0 407 152 BB	Volkswagen 1K0 407 152 BE	Volkswagen 1K0 407 152 BG	Volkswagen 1K0 407 152 BL
Skoda 1K0 407 152 BB	Skoda 1K0 407 152 BE										
Skoda 1K0 407 152 BG	Skoda 1K0 407 152 BL										
Volkswagen 1K0 407 152 BB	Volkswagen 1K0 407 152 BE										
Volkswagen 1K0 407 152 BG	Volkswagen 1K0 407 152 BL										
<p><b>Application info</b></p> <table border="0"> <tr> <td>Skoda Octavia II (1Z_) (02/04-06/13)</td> <td>Skoda Superb II (3T) (03/08-05/15)</td> </tr> <tr> <td>Skoda Yeti (5L) (05/09-12/17)</td> <td>Volkswagen Caddy III (2KA, 2KB) (03/04-05/15)</td> </tr> <tr> <td>Volkswagen Caddy IV (SA_) (05/15--)</td> <td></td> </tr> </table>				Skoda Octavia II (1Z_) (02/04-06/13)	Skoda Superb II (3T) (03/08-05/15)	Skoda Yeti (5L) (05/09-12/17)	Volkswagen Caddy III (2KA, 2KB) (03/04-05/15)	Volkswagen Caddy IV (SA_) (05/15--)			
Skoda Octavia II (1Z_) (02/04-06/13)	Skoda Superb II (3T) (03/08-05/15)										
Skoda Yeti (5L) (05/09-12/17)	Volkswagen Caddy III (2KA, 2KB) (03/04-05/15)										
Volkswagen Caddy IV (SA_) (05/15--)											
Control arm		116 050 0118	MCA1024								
<p><b>Notes</b></p> <p>Control Arm Front Axle Left Sheet Steel with ball joint with rubber mount</p> <p>Article number of recommended accessory: 100 654 0015 Paired article number: 116 050 0119   MCA1025 Required quantity: 1 replacement in pairs recommended</p>		 									
<p><b>References</b></p> <table border="0"> <tr> <td>Skoda 1K0 407 151 BB</td> <td>Skoda 1K0 407 151 BE</td> </tr> <tr> <td>Skoda 1K0 407 151 BG</td> <td>Volkswagen 1K0 407 151 BB</td> </tr> <tr> <td>Volkswagen 1K0 407 151 BE</td> <td>Volkswagen 1K0 407 151 BG</td> </tr> </table>				Skoda 1K0 407 151 BB	Skoda 1K0 407 151 BE	Skoda 1K0 407 151 BG	Volkswagen 1K0 407 151 BB	Volkswagen 1K0 407 151 BE	Volkswagen 1K0 407 151 BG		
Skoda 1K0 407 151 BB	Skoda 1K0 407 151 BE										
Skoda 1K0 407 151 BG	Volkswagen 1K0 407 151 BB										
Volkswagen 1K0 407 151 BE	Volkswagen 1K0 407 151 BG										

**Application info**

Skoda Octavia II (1Z\_) (02/04-06/13)

Skoda Yeti (5L) (05/09-12/17)

Volkswagen Caddy IV (SA\_) (05/15--)

Skoda Superb II (3T) (03/08-05/15)

Volkswagen Caddy III (2KA, 2KB) (03/04-05/15)

**Control arm**

116 050 0119

MCA1025

**Notes**

Control Arm  
Front Axle Right  
Sheet Steel  
with ball joint  
with rubber mount

Article number of recommended accessory 100 654 0015  
Paired article number 116 050 0118 | MCA1024  
Required quantity 1  
replacement in pairs recommended



**References**

Skoda 1K0 407 152 BB

Skoda 1K0 407 152 BG

Volkswagen 1K0 407 152 BE

Skoda 1K0 407 152 BE

Volkswagen 1K0 407 152 BB

Volkswagen 1K0 407 152 BG

**Application info**

Skoda Octavia II (1Z\_) (02/04-06/13)

Skoda Yeti (5L) (05/09-12/17)

Volkswagen Caddy IV (SA\_) (05/15--)

Skoda Superb II (3T) (03/08-05/15)

Volkswagen Caddy III (2KA, 2KB) (03/04-05/15)

**Control arm**

116 050 0123/S

MCA1013

**Notes**

Control Arm  
Front Axle Left  
Sheet Steel  
with fastening material  
with rubber mount

Paired article number 116 050 0124/S | MCA1014  
Required quantity 1  
replacement in pairs recommended





**References**

Audi 5Q0 407 151 AC  
 Audi 5Q0 407 151 J  
 Audi 5WA 407 151  
 Seat 5Q0 407 151 L  
 Seat 5Q0 407 151 S  
 Skoda 5Q0 407 151 P  
 Volkswagen 5Q0 407 151 AC  
 Volkswagen 5Q0 407 151 J  
 Volkswagen 5Q0 407 151 R  
 Volkswagen 5Q0 407 153 H  
 Volkswagen 5WA 407 151 C

Audi 5Q0 407 151 G  
 Audi 5Q0 407 151 R  
 Audi (FAW) 5Q0 407 151 J  
 Seat 5Q0 407 151 M  
 Skoda 5Q0 407 151 L  
 Skoda (SVW) 5Q0 407 151 L  
 Volkswagen 5Q0 407 151 G  
 Volkswagen 5Q0 407 151 M  
 Volkswagen 5Q0 407 151 S  
 Volkswagen 5WA 407 151  
 Volkswagen 5WA 407 153

**Application info**

Audi A3 III (8V\_) (04/12--)  
 Audi Q2 (06/16--)  
 Skoda Octavia III (5E\_) (11/12--)  
 Volkswagen Golf VIII (CB1) (07/19--)

Audi A3 IV (8Y\_) (11/19--)  
 Seat Leon III (5F\_) (09/12--)  
 Volkswagen Golf VII (5G1,BA5) (08/12--)  
 Volkswagen T-Roc (A11) (07/17--)

**Control arm****116 050 0124/S****MCA1014****Notes**

Control Arm  
 Front Axle Right  
 Sheet Steel  
 with fastening material  
 with rubber mount  
 Paired article number 116 050 0123/S | MCA1013  
 Required quantity 1  
 replacement in pairs recommended

**References**

Audi 5Q0 407 152 AC  
 Audi 5Q0 407 152 J  
 Audi 5WA 407 152  
 Seat 5Q0 407 152 L  
 Seat 5Q0 407 152 S  
 Skoda 5Q0 407 152 P  
 Volkswagen 5Q0 407 152 AC  
 Volkswagen 5Q0 407 152 J  
 Volkswagen 5Q0 407 152 R  
 Volkswagen 5Q0 407 154 H  
 Volkswagen 5WA 407 152 C

Audi 5Q0 407 152 G  
 Audi 5Q0 407 152 R  
 Audi (FAW) 5Q0 407 152 J  
 Seat 5Q0 407 152 M  
 Skoda 5Q0 407 152 L  
 Skoda (SVW) 5Q0 407 152 L  
 Volkswagen 5Q0 407 152 G  
 Volkswagen 5Q0 407 152 M  
 Volkswagen 5Q0 407 152 S  
 Volkswagen 5WA 407 152  
 Volkswagen 5WA 407 154

**Application info**

Audi A3 III (8V\_) (04/12--)

Audi Q2 (06/16--)

Skoda Octavia III (5E\_) (11/12--)

Volkswagen Golf VIII (CB1) (07/19--)

Audi A3 IV (8Y\_) (11/19--)

Seat Leon III (5F\_) (09/12--)

Volkswagen Golf VII (5G1,BA5) (08/12--)

Volkswagen T-Roc (A11) (07/17--)

**Control arm****116 050 0125****MCA0820****Notes**

Control Arm  
 Front Axle Left  
 Sheet Steel  
 with rubber mount  
 without ball joint

Paired article number

116 050 0126 | MCA0821

Required quantity

1

replacement in pairs recommended

**References**

Volkswagen 5C0 407 151 A

Volkswagen 5C0 407 151 D

Volkswagen 5C0 407 151 B

**Application info**

Volkswagen Jetta IV (162) (01/08--)

**Control arm****116 050 0126****MCA0821****Notes**

Control Arm  
 Front Axle Right  
 Sheet Steel  
 with rubber mount  
 without ball joint

Paired article number

116 050 0125 | MCA0820

Required quantity

1

replacement in pairs recommended

**References**

Volkswagen 5C0 407 152 A

Volkswagen 5C0 407 152 D

Volkswagen 5C0 407 152 B

**Application info**

Volkswagen Jetta IV (162) (01/08--)

**Control arm** 116 050 0127/HD MCA1147HD

**Notes**

Aluminium  
 Carbon Neutral  
 Control Arm  
 Front Axle Left  
 Lower  
 Rear  
 with fastening material  
 with rubber mount

Paired article number 116 050 0128/HD | MCA1148HD

Replace in pairs only

Required quantity 1

Thread Size M14x1,5

reinforced version



**References**

- |                       |                        |
|-----------------------|------------------------|
| Audi 8K0 407 693 AA   | Audi 8K0 407 693 AD    |
| Audi 8K0 407 693 Q    | Audi 8K0 407 695 H     |
| Audi 8R0 407 693      | Audi 8R0 407 693 D     |
| Porsche 8R0 407 693 B | Porsche 9A7 407 693 03 |

**Application info**

- |                                |                                     |
|--------------------------------|-------------------------------------|
| Audi A4 IV (8K_) (08/07-05/16) | Audi A5 I (8F_ , 8T_) (06/07-01/17) |
| Audi Q5 I (8R_) (11/08-12/17)  | Porsche Macan (95B) (02/14--)       |

**Control arm** 116 050 0128/HD MCA1148HD

**Notes**

Aluminium  
 Carbon Neutral  
 Control Arm  
 Front Axle Right  
 Lower  
 Rear  
 with fastening material  
 with rubber mount

Paired article number 116 050 0127/HD | MCA1147HD

Replace in pairs only

Required quantity 1

Thread Size M14x1,5

reinforced version



**References**

Audi 8K0 407 694 AA	Audi 8K0 407 694 AD
Audi 8K0 407 694 Q	Audi 8K0 407 696 H
Audi 8R0 407 694	Audi 8R0 407 694 D
Porsche 8R0 407 694 B	Porsche 9A7 407 694 03

**Application info**

Audi A4 IV (8K_) (08/07-05/16)	Audi A5 I (8F_ , 8T_) (06/07-01/17)
Audi Q5 I (8R_) (11/08-12/17)	Porsche Macan (95B) (02/14--)

**Control arm**

116 050 0139/HD

MCA0985HD

**Notes**

Aluminium  
Carbon Neutral  
Control Arm  
Front Axle Left  
Lower  
Rear  
with accessories  
with rubber mount

Paired article number 116 050 0140/HD | MCA0986HD  
Replace in pairs only  
Required quantity 1  
reinforced version



**References**

Audi 4D0 407 693 AE	Audi 8E0 407 693 D
---------------------	--------------------

**Application info**

Audi A8 I (4D\_) (03/94-12/05)

Control arm		116 050 0140/HD	MCA0986HD
<p><b>Notes</b></p> <p>Aluminium Carbon Neutral Control Arm Front Axle Right Lower Rear with accessories with rubber mount</p> <p>Paired article number Replace in pairs only Required quantity reinforced version</p>	<p>116 050 0139/HD   MCA0985HD</p> <p>1</p>		

References	
Audi 4D0 407 694 AE	Audi 8E0 407 694 D

Application info	
Audi A8 I (4D_) (03/94-12/05)	

Control arm		116 050 0143/HD	MCA1027HD
<p><b>Notes</b></p> <p>Carbon Neutral Rear Axle Left Sheet Steel Trailing Arm with fastening material with rubber mount</p> <p>Paired article number Replace in pairs only Required quantity reinforced version</p>	<p>116 050 0144/HD   MCA1028HD</p> <p>1</p>		

**References**

Audi 3C0 505 223	Audi 3C0 505 223 A
Audi 3C0 505 223 C	Audi 3C0 505 223 D
Audi 3C0 505 223 E	Seat 3C0 505 223
Seat 3C0 505 223 A	Seat 3C0 505 223 C
Seat 3C0 505 223 E	Skoda 3C0 505 223
Skoda 3C0 505 223 A	Skoda 3C0 505 223 C
Skoda 3C0 505 223 E	Volkswagen 3C0 505 223
Volkswagen 3C0 505 223 A	Volkswagen 3C0 505 223 B
Volkswagen 3C0 505 223 C	Volkswagen 3C0 505 223 D
Volkswagen 3C0 505 223 E	Volkswagen 3C0 505 223 F

**Application info**

Audi Q3 I (8U_) (06/11-12/18)	Seat Alhambra II (710) (06/10--)
Volkswagen CC (11/11-12/16)	Volkswagen Passat (362, 365) (08/10-12/15)
Volkswagen Passat (3C_) (03/05-01/12)	Volkswagen Sharan (7N) (05/10--)
Volkswagen Tiguan I (5N) (09/07-07/18)	

**Control arm****116 050 0144/HD****MCA1028HD****Notes**

Carbon Neutral  
Rear Axle Right  
Sheet Steel  
Trailing Arm  
with fastening material  
with rubber mount  
116 050 0143/HD | MCA1027HD

Paired article number  
Replace in pairs only  
Required quantity  
reinforced version

1

**References**

Audi 3C0 505 224 D	Seat 3C0 505 224 C
Seat 3C0 505 224 E	Volkswagen 3C0 505 224 B
Volkswagen 3C0 505 224 C	Volkswagen 3C0 505 224 D
Volkswagen 3C0 505 224 E	Volkswagen 3C0 505 224 F

**Application info**

Audi Q3 I (8U_) (06/11-12/18)	Seat Alhambra II (710) (06/10--)
Volkswagen CC (11/11-12/16)	Volkswagen Passat (362, 365) (08/10-12/15)
Volkswagen Passat (3C_) (03/05-01/12)	Volkswagen Sharan (7N) (05/10--)
Volkswagen Tiguan I (5N) (09/07-07/18)	

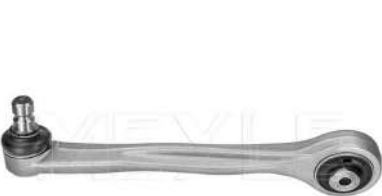
Control arm		116 050 0145/HD	MCA1007HD
<p><b>Notes</b></p> <p>Aluminium Carbon Neutral Control Arm Front Front Axle Left Upper with ball joint with rubber mount</p> <p>Paired article number Replace in pairs only Required quantity reinforced version</p>			
<p>116 050 0146/HD   MCA1008HD</p> <p>1</p>			

References	
Audi 4H0 407 505 D	Audi 4H0 407 505 E
Audi 4H0 407 505 F	

Application info
Audi A8 III (4H_) (11/09-01/18)

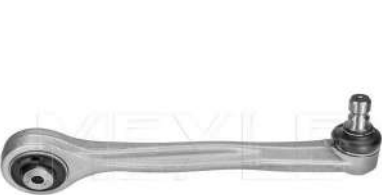
Control arm		116 050 0146/HD	MCA1008HD
<p><b>Notes</b></p> <p>Aluminium Carbon Neutral Control Arm Front Front Axle Right Upper with ball joint with rubber mount</p> <p>Paired article number Replace in pairs only Required quantity reinforced version</p>			
<p>116 050 0145/HD   MCA1007HD</p> <p>1</p>			

References	
Audi 4H0 407 506 D	Audi 4H0 407 506 E
Audi 4H0 407 506 F	

Application info
Audi A8 III (4H_) (11/09-01/18)

Control arm		116 050 0147/HD	MCA1009HD
<p><b>Notes</b></p> <p>Aluminium Carbon Neutral Control Arm Front Axle Left Rear Upper with ball joint with rubber mount</p> <p>Paired article number Replace in pairs only Required quantity reinforced version</p>	<p>116 050 0148/HD   MCA1010HD</p> <p>1</p>		

References			
Audi 4H0 407 509 A		Audi 4H0 407 509 D	
Audi 4H0 407 509 E		Audi 4H0 407 509 F	

Application info	
Audi A8 III (4H_) (11/09-01/18)	

Control arm		116 050 0148/HD	MCA1010HD
<p><b>Notes</b></p> <p>Aluminium Carbon Neutral Control Arm Front Axle Right Rear Upper with ball joint with rubber mount</p> <p>Paired article number Replace in pairs only Required quantity reinforced version</p>	<p>116 050 0147/HD   MCA1009HD</p> <p>1</p>		

References			
Audi 4H0 407 510 A		Audi 4H0 407 510 D	
Audi 4H0 407 510 E		Audi 4H0 407 510 F	

Application info	
Audi A8 III (4H_) (11/09-01/18)	



<b>Control arm</b>	<b>116 050 0154/HD</b>	<b>MCA0202HD</b>
--------------------	------------------------	------------------

<p><b>Notes</b></p> <p>Paired article number Replace in pairs only Required quantity reinforced version</p>	<p>Carbon Neutral Control Arm Front Axle Left Lower Sheet Steel with rubber mount</p> <p>116 050 0155/HD   MCA0203HD</p> <p>1</p>	
---	---	---

<b>References</b>		
Audi 895 407 147 A		

<b>Application info</b>		
Audi 80 (8C, 8G7, B4) (05/91-08/00)		Audi 80/90 (89, 89Q, 8A, B3) (06/86-12/96)

<b>Control arm</b>	<b>116 050 0155/HD</b>	<b>MCA0203HD</b>
--------------------	------------------------	------------------

<p><b>Notes</b></p> <p>Paired article number Replace in pairs only Required quantity reinforced version</p>	<p>Carbon Neutral Control Arm Front Axle Right Lower Sheet Steel with rubber mount</p> <p>116 050 0154/HD   MCA0202HD</p> <p>1</p>	
---	--	---

<b>References</b>		
Audi 895 407 148 A		

<b>Application info</b>		
Audi 80 (8C, 8G7, B4) (05/91-08/00)		Audi 80/90 (89, 89Q, 8A, B3) (06/86-12/96)

**Control arm**

**116 050 0156**

**MCA0204**

**Notes**

Control Arm  
 Front Axle Left  
 Front Axle Right  
 Lower  
 Sheet Steel  
 with rubber mount

Required quantity  
 replacement in pairs recommended

2



**References**

Audi 1J0 407 151 A  
 Audi 1J0 407 151 C  
 Skoda 1J0 407 151 C  
 Volkswagen 1J0 407 151 B  
 Volkswagen (FAW) 1J0 407 151 C

Audi 1J0 407 151 B  
 Seat 1J0 407 151 C  
 Volkswagen 1J0 407 151 A  
 Volkswagen 1J0 407 151 C  
 Volkswagen (SVW) 1JD 407 151 A

**Application info**

Audi A3 I (8L\_) (09/96-09/06)  
 Seat Leon II / Toledo III / Altea (1P\_ ,5P\_) (03/04--)  
 Volkswagen Bora (1J2, 1J6) (10/98-12/13)  
 Volkswagen Golf IV (1J1, 1J5) (08/97-06/14)  
 Volkswagen Jetta City (09/06-12/09)

Seat Leon I / Toledo II (1M\_) (10/98-06/06)  
 Skoda Octavia I (1U\_) (09/96-12/10)  
 Volkswagen Bora V (Mex) (01/07--)  
 Volkswagen Golf VI (5K1, 517, AJ5) (10/08-05/16)  
 Volkswagen New Beetle (1Y7, 9C1, 1C1) (01/98-12/11)

**Control arm**

**116 050 0157**

**MCA1333**

**Notes**

Aluminium  
 Front  
 Rear Axle Left  
 Trailing Arm  
 Upper  
 outer

Paired article number  
 Required quantity  
 replacement in pairs recommended

116 050 0158 | MCA1334  
 1



**References**

Audi 8W0 505 323 F

Audi (FAW) 8W0 505 323 F

**Application info**

Audi A4 V (8W\_) (05/15--)

Audi A5 II (F5\_) (06/16--)

**Control arm****116 050 0158****MCA1334****Notes**

Aluminium  
 Front  
 Rear Axle Right  
 Trailing Arm  
 Upper  
 outer

Paired article number

116 050 0157 | MCA1333

Required quantity

1

replacement in pairs recommended

**References**

Audi 8W0 505 324 F

Audi (FAW) 8W0 505 324 F

**Application info**

Audi A4 V (8W\_) (05/15--)

Audi A5 II (F5\_) (06/16--)

**Control arm****116 050 0164****MCA0207****Notes**

Aluminium  
 Control Arm  
 Rear Axle Left  
 Rear Axle Right

Length [mm]

293

Required quantity

2

replacement in pairs recommended

**References**

Audi 4D0 501 529 H

**Application info**

Audi A8 I (4D\_) (03/94-12/05)

## Control arm

116 050 0165/HD

MCA0208HD

## Notes

Aluminium  
Carbon Neutral  
Control Arm  
Front Axle Right  
Rear  
Upper  
with rubber mount



Length [mm]

233

Paired article number

116 050 0166/HD | MCA0209HD

Replace in pairs only

Required quantity

1

reinforced version

## References

Audi 8K0 407 510 A

Audi 8K0 407 510 J

Audi 8K0 407 510 N

Audi 8K0 407 510 R

Audi (FAW) 4GD 407 510 A

Audi (FAW) 4GD 497 510 A

Audi (FAW) 8KD 407 510

Audi (FAW) 8KD 407 510 B

Porsche 8K0 407 510 B

Audi 8K0 407 510 B

Audi 8K0 407 510 M

Audi 8K0 407 510 P

Audi (FAW) 4GD 407 510

Audi (FAW) 4GD 407 510 B

Audi (FAW) 4GD 497 510 B

Audi (FAW) 8KD 407 510 A

Porsche 8K0 407 510 A

Porsche 8K0 407 510 P

## Application info

Audi A4 IV (8K\_) (08/07-05/16)

Audi A6 IV (4G2, 4G5, C7) (11/10-09/18)

Audi Q5 I (8R\_) (11/08-12/17)

Audi A5 I (8F\_, 8T\_) (06/07-01/17)

Audi A7 I Sportback (4G\_) (07/10-05/18)

Porsche Macan (95B) (02/14--)

## Control arm

116 050 0166/HD

MCA0209HD

## Notes

Aluminium  
Carbon Neutral  
Control Arm  
Front Axle Left  
Rear  
Upper  
with rubber mount



Length [mm]

233

Paired article number

116 050 0165/HD | MCA0208HD

Replace in pairs only

Required quantity

1

reinforced version

## References

Audi 8K0 407 509 A

Audi 8K0 407 509 J

Audi 8K0 407 509 N

Audi 8K0 407 509 R

Audi (FAW) 4GD 407 509 J

Audi (FAW) 8KD 407 509

Audi (FAW) 8KD 407 509 B

Porsche 8K0 407 509 N

Audi 8K0 407 509 B

Audi 8K0 407 509 M

Audi 8K0 407 509 P

Audi (FAW) 4GD 407 509 B

Audi (FAW) 4GD 497 509

Audi (FAW) 8KD 407 509 A

Porsche 8K0 407 509 B

Porsche 8K0 407 509 P

## Application info

Audi A4 IV (8K\_) (08/07-05/16)

Audi A6 IV (4G2, 4G5, C7) (11/10-09/18)

Audi Q5 I (8R\_) (11/08-12/17)

Audi A5 I (8F\_ , 8T\_) (06/07-01/17)

Audi A7 I Sportback (4G\_) (07/10-05/18)

Porsche Macan (95B) (02/14--)

## Control arm

116 050 0167/HD

MCA0210HD

## Notes

Aluminium  
Carbon Neutral  
Control Arm  
Front  
Front Axle Right  
Upper  
with ball joint  
with rubber mount

Length [mm]

269

Paired article number

116 050 0168/HD | MCA0211HD

Replace in pairs only

Required quantity

1

reinforced version



## References

Audi 8K0 407 506 A

Audi 8K0 407 506 B

Audi 8K0 407 506 J

Audi 8K0 407 506 M

Audi 8K0 407 506 N

Audi 8K0 407 506 R

Audi (FAW) 4GD 407 506

Audi (FAW) 4GD 407 506 A

Audi (FAW) 8KD 407 506

Audi (FAW) 8KD 407 506 A

Audi (FAW) 8KD 407 506 B

Porsche 8K0 407 506 A

## Application info

Audi A4 IV (8K\_) (08/07-05/16)



Audi A5 I (8F\_ , 8T\_) (06/07-01/17)

Audi A6 IV (4G2, 4G5, C7) (11/10-09/18)

Audi A7 I Sportback (4G\_) (07/10-05/18)

Audi Q5 I (8R\_) (11/08-12/17)

Porsche Macan (95B) (02/14--)

Control arm		116 050 0168/HD	MCA0211HD
<b>Notes</b>			
	Aluminium		
	Carbon Neutral		
	Control Arm		
	Front		
	Front Axle Left		
	Upper		
	with ball joint		
	with rubber mount		
Length [mm]	269		
Paired article number	116 050 0167/HD   MCA0210HD		
Replace in pairs only			
Required quantity	1		
reinforced version			
<b>References</b>			
Audi 8K0 407 505 A		Audi 8K0 407 505 B	
Audi 8K0 407 505 J		Audi 8K0 407 505 M	
Audi 8K0 407 505 N		Audi 8K0 407 505 R	
Audi (FAW) 4GD 407 505		Audi (FAW) 4GD 407 505 A	
Audi (FAW) 8KD 407 505		Audi (FAW) 8KD 407 505 A	
Audi (FAW) 8KD 407 505 B		Porsche 8K0 407 505 A	
<b>Application info</b>			
Audi A4 IV (8K_) (08/07-05/16)		Audi A5 I (8F_ , 8T_) (06/07-01/17)	
Audi A6 IV (4G2, 4G5, C7) (11/10-09/18)		Audi A7 I Sportback (4G_) (07/10-05/18)	
Audi Q5 I (8R_) (11/08-12/17)		Porsche Macan (95B) (02/14--)	
Control arm		116 050 0169/HD	MCA0212HD
<b>Notes</b>			
	Aluminium		
	Carbon Neutral		
	Control Arm		
	Front		
	Front Axle Right		
	Lower		
	with rubber mount		
Bore Diameter [mm]	14		
Paired article number	116 050 0170/HD   MCA0213HD		
Replace in pairs only			
Required quantity	1		
reinforced version			

**References**

Audi 8K0 407 152 B  
Audi 8K0 407 152 D

Audi 8K0 407 152 C

**Application info**

Audi A4 IV (8K\_) (08/07-05/16)  
Audi A6 IV (4G2, 4G5, C7) (11/10-09/18)  
Audi Q5 I (8R\_) (11/08-12/17)

Audi A5 I (8F\_ , 8T\_) (06/07-01/17)  
Audi A7 I Sportback (4G\_) (07/10-05/18)

**Control arm****116 050 0170/HD****MCA0213HD****Notes**

Aluminium  
Carbon Neutral  
Control Arm  
Front  
Front Axle Left  
Lower  
with rubber mount

Bore Diameter [mm]

14

Paired article number

116 050 0169/HD | MCA0212HD

Replace in pairs only

Required quantity

1

reinforced version

**References**

Audi 8K0 407 151 B  
Audi 8K0 407 151 D

Audi 8K0 407 151 C

**Application info**

Audi A4 IV (8K\_) (08/07-05/16)  
Audi A6 IV (4G2, 4G5, C7) (11/10-09/18)  
Audi Q5 I (8R\_) (11/08-12/17)

Audi A5 I (8F\_ , 8T\_) (06/07-01/17)  
Audi A7 I Sportback (4G\_) (07/10-05/18)



## Control arm

116 050 0171/HD

MCA0214HD

## Notes

Aluminium  
Carbon Neutral  
Control Arm  
Front Axle Right  
Lower  
Rear  
with ball joint  
with rubber mount

Paired article number  
Replace in pairs only  
Required quantity  
Thread Size  
reinforced version

116 050 0172/HD | MCA0215HD

1

M12x1,5



## References

Audi 8K0 407 694 AE

Audi 8K0 407 694 H

Audi 8K0 407 694 N

Audi 8K0 407 694 F

Audi 8K0 407 694 K

Audi 8K0 407 694 R

## Application info

Audi A4 IV (8K\_) (08/07-05/16)

Audi Q5 I (8R\_) (11/08-12/17)

Audi A5 I (8F\_ , 8T\_) (06/07-01/17)

## Control arm

116 050 0172/HD

MCA0215HD

## Notes

Aluminium  
Carbon Neutral  
Control Arm  
Front Axle Left  
Lower  
Rear  
with ball joint  
with rubber mount

Paired article number  
Replace in pairs only  
Required quantity  
Thread Size  
reinforced version

116 050 0171/HD | MCA0214HD

1

M12x1,5



**References**

Audi 8K0 407 693 AE  
 Audi 8K0 407 693 H  
 Audi 8K0 407 693 N

Audi 8K0 407 693 F  
 Audi 8K0 407 693 K  
 Audi 8K0 407 693 R

**Application info**

Audi A4 IV (8K\_) (08/07-05/16)  
 Audi Q5 I (8R\_) (11/08-12/17)

Audi A5 I (8F\_ , 8T\_) (06/07-01/17)

**Control arm**

116 050 0173/HD

MCA0216HD

**Notes**

Aluminium  
 Carbon Neutral  
 Control Arm  
 Front Axle Right  
 Lower  
 Rear  
 with ball joint  
 with fastening material  
 with rubber mount

Paired article number  
 Replace in pairs only  
 Required quantity  
 Thread Size  
 reinforced version

116 050 0174/HD | MCA0217HD

1  
 M14x1,5



**References**

Audi 8K0 407 694 AF  
 Audi 8K0 407 694 T





Audi 8K0 407 694 S

**Application info**

Audi A4 IV (8K\_) (08/07-05/16)  
 Audi Q5 I (8R\_) (11/08-12/17)

Audi A5 I (8F\_ , 8T\_) (06/07-01/17)



Control arm		116 050 0176	MCA1337
<p><b>Notes</b></p> <p>Control Arm Front Axle Right Sheet Steel with ball joint with rubber mount</p> <p>Paired article number 116 050 0175   MCA1336 Required quantity 1 replacement in pairs recommended</p>		 	
<p><b>References</b></p> <p>Volkswagen 561 407 152 A Volkswagen 561 407 152 C</p>			
<p><b>Application info</b></p> <p>Volkswagen Beetle (5C1) (04/11-07/19) Volkswagen Passat (A32) (01/11--)</p>			
Control arm		116 050 0177	MCA1338
<p><b>Notes</b></p> <p>Control Arm Front Axle Left Sheet Steel with rubber mount without ball joint</p> <p>Paired article number 116 050 0178   MCA1339 Required quantity 1 replacement in pairs recommended</p>		 	
<p><b>References</b></p> <p>Volkswagen 561 407 151 A Volkswagen 561 407 151 C</p>			
<p><b>Application info</b></p> <p>Volkswagen Beetle (5C1) (04/11-07/19) Volkswagen Passat (A32) (01/11--)</p>			

**Control arm**

116 050 0178

MCA1339

**Notes**

Control Arm  
 Front Axle Right  
 Sheet Steel  
 with rubber mount  
 Paired article number 116 050 0177 | MCA1338  
 Required quantity 1  
 replacement in pairs recommended



**References**

Volkswagen 561 407 152 A

Volkswagen 561 407 152 C

**Application info**

Volkswagen Beetle (5C1) (04/11-07/19)

Volkswagen Passat (A32) (01/11--)

**Control arm**

116 050 0179/HD

MCA1208HD

**Notes**

Carbon Neutral  
 Control Arm  
 Rear Axle Left  
 Sheet Steel  
 with fastening material  
 with rubber mount  
 Paired article number 116 050 0180/HD | MCA1209HD  
 Replace in pairs only  
 Required quantity 1  
 reinforced version



**References**

Audi 5Q0 505 223 D

Seat 5Q0 505 223 D

Skoda 5Q0 505 223 D

Volkswagen 5Q0 505 223 D

**Application info**

Audi A1 I (8X\_) (05/10-10/18)

Audi A3 IV (8Y\_) (11/19--)

Audi TT III (8S\_) (07/14--)

Seat Leon III (5F\_) (09/12--)

Skoda Octavia III (5E\_) (11/12--)

Skoda Superb III (3V\_) (03/15--)

Volkswagen Golf VII (5G1,BA5) (08/12--)

Volkswagen Jetta VII (BU3) (12/17--)

Volkswagen T-Roc (A11) (07/17--)

Volkswagen Touran II (5T1) (05/15--)

Audi A3 III (8V\_) (04/12--)

Audi Q2 (06/16--)

Seat Ateca (04/16--)

Skoda Karoq (07/17--)

Skoda Octavia IV (NX\_) (11/19--)

Volkswagen Arteon (03/17--)

Volkswagen Golf VIII (CB1) (07/19--)

Volkswagen Passat (B8) (08/14--)

Volkswagen Taos (CL1, CQ1) (10/20--)

**Control arm****116 050 0180/HD****MCA1209HD****Notes**

Carbon Neutral  
Control Arm  
Rear Axle Right  
Sheet Steel  
with fastening material  
with rubber mount

Paired article number

116 050 0179/HD | MCA1208HD

Replace in pairs only

Required quantity

1

reinforced version

**References**

Audi 5Q0 505 224 D

Skoda 5Q0 505 224 D

Seat 5Q0 505 224 D

Volkswagen 5Q0 505 224 D

**Application info**

Audi A1 I (8X\_) (05/10-10/18)

Audi A3 IV (8Y\_) (11/19--)

Audi TT III (8S\_) (07/14--)

Seat Leon III (5F\_) (09/12--)

Skoda Octavia III (5E\_) (11/12--)

Skoda Superb III (3V\_) (03/15--)

Volkswagen Golf VII (5G1,BA5) (08/12--)

Volkswagen Jetta VII (BU3) (12/17--)

Volkswagen T-Roc (A11) (07/17--)

Volkswagen Touran II (5T1) (05/15--)

Audi A3 III (8V\_) (04/12--)

Audi Q2 (06/16--)

Seat Ateca (04/16--)

Skoda Karoq (07/17--)

Skoda Octavia IV (NX\_) (11/19--)

Volkswagen Arteon (03/17--)

Volkswagen Golf VIII (CB1) (07/19--)

Volkswagen Passat (B8) (08/14--)

Volkswagen Taos (CL1, CQ1) (10/20--)

**Control arm**

116 050 0181/HD

MCA0822HD

**Notes**

Carbon Neutral  
Control Arm  
Front Axle Left  
Sheet Steel  
with ball joint  
with rubber mount



Article number of recommended accessories 100 654 0008  
Length [mm] 372.6  
Paired article number 116 050 0182/HD | MCA0823HD  
Replace in pairs only  
Required quantity 1  
Thread Size M12x1,5  
Width [mm] 328.6  
reinforced version

**References**

- |                                 |                                |
|---------------------------------|--------------------------------|
| Audi 1K0 407 151 AA             | Audi 1K0 407 151 AB            |
| Audi 1K0 407 151 AE             | Audi 1K0 407 151 AH            |
| Audi 1K0 407 151 BC             | Audi 1K0 407 151 BD            |
| Audi 1K0 407 151 N              | Audi 1K0 407 151 P             |
| Seat 1K0 407 151 AA             | Seat 1K0 407 151 AB            |
| Seat 1K0 407 151 AE             | Seat 1K0 407 151 AH            |
| Seat 1K0 407 151 BC             | Seat 1K0 407 151 BD            |
| Seat 1K0 407 151 N              | Seat 1K0 407 151 P             |
| Skoda 1K0 407 151 AA            | Skoda 1K0 407 151 AB           |
| Skoda 1K0 407 151 AE            | Skoda 1K0 407 151 AH           |
| Skoda 1K0 407 151 BC            | Skoda 1K0 407 151 N            |
| Skoda 1K0 407 151 P             | Volkswagen 1K0 407 151 AA      |
| Volkswagen 1K0 407 151 AB       | Volkswagen 1K0 407 151 AE      |
| Volkswagen 1K0 407 151 AH       | Volkswagen 1K0 407 151 BC      |
| Volkswagen 1K0 407 151 BD       | Volkswagen 1K0 407 151 N       |
| Volkswagen 1K0 407 151 P        | Volkswagen 2K0 407 151 B       |
| Volkswagen (FAW) 1K0 407 151 AA | Volkswagen (FAW) 1K0 407 151 P |

**Application info**

Audi A3 II (8P\_) (05/03-12/15)

Skoda Octavia II (1Z\_) (02/04-06/13)

Skoda Superb II (3T) (03/08-05/15)

Volkswagen Bora V (Mex) (01/07--)

Volkswagen Eos (03/06-08/15)

Volkswagen Golf VI (5K1, 517, AJ5) (10/08-05/16)

Volkswagen Scirocco III (137) (05/08-11/17)

Seat Leon II / Toledo III / Altea (1P\_ ,5P\_) (03/04--)

Skoda Roomster (03/06-05/15)

Skoda Yeti (5L) (05/09-12/17)

Volkswagen Caddy III (2KA, 2KB) (03/04-05/15)

Volkswagen Golf V (1K1, 1K5, 5M1) (10/03-08/14)

Volkswagen Jetta III (1K2) (09/04-12/13)

Volkswagen Touran I ( 1T1/2/3) (02/03-05/15)

**Control arm****116 050 0182/HD****MCA0823HD****Notes**

Carbon Neutral  
Control Arm  
Front Axle Right  
Sheet Steel  
with ball joint  
with rubber mount

Article number of recommended accessories 100 654 0008  
Length [mm] 372.6  
Paired article number 116 050 0181/HD | MCA0822HD  
Replace in pairs only  
Required quantity 1  
Thread Size M12x1,5  
Width [mm] 328.6  
reinforced version





**References**

Audi 1K0 407 152 AA	Audi 1K0 407 152 AB
Audi 1K0 407 152 AE	Audi 1K0 407 152 AH
Audi 1K0 407 152 BC	Audi 1K0 407 152 BD
Audi 1K0 407 152 N	Audi 1K0 407 152 P
Seat 1K0 407 152 AA	Seat 1K0 407 152 AB
Seat 1K0 407 152 AE	Seat 1K0 407 152 AH
Seat 1K0 407 152 BC	Seat 1K0 407 152 BD
Seat 1K0 407 152 N	Seat 1K0 407 152 P
Skoda 1K0 407 152 AA	Skoda 1K0 407 152 AB
Skoda 1K0 407 152 AE	Skoda 1K0 407 152 AH
Skoda 1K0 407 152 BC	Skoda 1K0 407 152 N
Skoda 1K0 407 152 P	Volkswagen 1K0 407 152 AA
Volkswagen 1K0 407 152 AB	Volkswagen 1K0 407 152 AE
Volkswagen 1K0 407 152 AH	Volkswagen 1K0 407 152 BC
Volkswagen 1K0 407 152 BD	Volkswagen 1K0 407 152 N
Volkswagen 1K0 407 152 P	Volkswagen 2K0 407 152 B
Volkswagen (FAW) 1K0 407 152 AA	Volkswagen (FAW) 1K0 407 152P

**Application info**

Audi A3 II (8P_) (05/03-12/15)	Seat Leon II / Toledo III / Altea (1P_ ,5P_) (03/04--)
Skoda Octavia II (1Z_) (02/04-06/13)	Skoda Roomster (03/06-05/15)
Skoda Superb II (3T) (03/08-05/15)	Skoda Yeti (5L) (05/09-12/17)
Volkswagen Bora V (Mex) (01/07--)	Volkswagen Caddy III (2KA, 2KB) (03/04-05/15)
Volkswagen Eos (03/06-08/15)	Volkswagen Golf V (1K1, 1K5, 5M1) (10/03-08/14)
Volkswagen Golf VI (5K1, 517, AJ5) (10/08-05/16)	Volkswagen Jetta III (1K2) (09/04-12/13)
Volkswagen Scirocco III (137) (05/08-11/17)	Volkswagen Touran I ( 1T1/2/3) (02/03-05/15)

**Control arm****116 050 0183/HD****MCA0824HD****Notes**

Carbon Neutral  
Control Arm  
Front Axle Right  
Sheet Steel  
with rubber mount  
without ball joint

Paired article number  
116 050 0184/HD | MCA0825HD

Replace in pairs only

Required quantity  
reinforced version 1

**References**

Volkswagen 5N0 407 152

**Application info**

Volkswagen CC (11/11-12/16)

Volkswagen Passat (3C\_) (03/05-01/12)

Volkswagen Passat (362, 365) (08/10-12/15)

Volkswagen Tiguan I (5N ) (09/07-07/18)

**Control arm**

116 050 0184/HD

MCA0825HD

**Notes**

Carbon Neutral  
Control Arm  
Front Axle Left  
Sheet Steel  
with rubber mount  
without ball joint

116 050 0183/HD | MCA0824HD

Paired article number

Replace in pairs only

Required quantity

1

reinforced version



**References**

Volkswagen 5N0 407 151

**Application info**

Volkswagen CC (11/11-12/16)

Volkswagen Passat (3C\_) (03/05-01/12)

Volkswagen Passat (362, 365) (08/10-12/15)

Volkswagen Tiguan I (5N ) (09/07-07/18)

**Control arm**

116 050 0185

MCA1112

**Notes**

Control Arm  
Rear Axle Left  
Rear Axle Right  
Steel

Required quantity

2

replacement in pairs recommended



**References**

Audi 4F0 505 323 E

Audi 4F0 505 323 K

Audi (FAW) 4F0 505 323 K

Audi 4F0 505 323 H

Audi 4F0 505 323 L

Audi (FAW) 4F0 505 323 L

**Application info**

Audi A6 III (4F2, 4FH, 4F5) (04/04-08/11)

**Control arm** 116 050 0186/HD MCA0950HD

**Notes**

Carbon Neutral  
 Cast Steel  
 Control Arm  
 Front Axle Right  
 Lower  
 with accessories  
 with ball joint  
 with rubber mount

Paired article number 116 050 0187/HD | MCA0951HD  
 Replace in pairs only  
 Required quantity 1  
 reinforced version



**References**

Audi 7L0 407 152 F  
 Audi 7L0 407 152 K  
 Porsche 955 341 018 61  
 Volkswagen 7L0 407 152 J

Audi 7L0 407 152 J  
 Porsche 955 341 018 60  
 Volkswagen 7L0 407 152 F  
 Volkswagen 7L0 407 152 K

**Application info**

Audi Q7 I (4L\_) (03/06-01/16)  
 Volkswagen Touareg I (7LA, 7L6 ,7L7 ) (10/02-01/13)

Porsche Cayenne I (955) (09/02-12/10)

**Control arm** 116 050 0187/HD MCA0951HD

**Notes**

Carbon Neutral  
 Cast Steel  
 Control Arm  
 Front Axle Left  
 Lower  
 with accessories  
 with ball joint  
 with rubber mount

Paired article number 116 050 0186/HD | MCA0950HD  
 Replace in pairs only  
 Required quantity 1  
 reinforced version



**References**

Audi 7L0 407 151 F  
 Audi 7L0 407 151 K  
 Porsche 955 341 017 61  
 Volkswagen 7L0 407 151 J

Audi 7L0 407 151 J  
 Porsche 955 341 017 60  
 Volkswagen 7L0 407 151 F  
 Volkswagen 7L0 407 151 K

**Application info**

Audi Q7 I (4L\_) (03/06-01/16)  
 Volkswagen Touareg I (7LA, 7L6 ,7L7 ) (10/02-01/13)

Porsche Cayenne I (955) (09/02-12/10)

**Control arm**

116 050 0195

MCA1165

**Notes**

Control Arm  
 Front Axle Left  
 Sheet Steel  
 with rubber mount  
 Paired article number 116 050 0196 | MCA1166  
 Required quantity 1  
 replacement in pairs recommended



**References**

Seat 3Q0 407 151 AA  
 Seat 3Q0 407 151 F  
 Seat 3Q0 407 151 T  
 Skoda 3Q0 407 151 E  
 Skoda 3Q0 407 151 J  
 Skoda 3Q0 407 151 S  
 Volkswagen 3Q0 407 151 E  
 Volkswagen 3Q0 407 151 G  
 Volkswagen 3Q0 407 151 J  
 Volkswagen 3Q0 407 151 L  
 Volkswagen 3Q0 407 151 N  
 Volkswagen 3Q0 407 151 S  
 Volkswagen (SVW) 3Q0 407 151 E  
 Volkswagen (SVW) 3QD 407 151 D

Seat 3Q0 407 151 E  
 Seat 3Q0 407 151 N  
 Skoda 3Q0 407 151 AA  
 Skoda 3Q0 407 151 F  
 Skoda 3Q0 407 151 P  
 Volkswagen 3Q0 407 151 AA  
 Volkswagen 3Q0 407 151 F  
 Volkswagen 3Q0 407 151 H  
 Volkswagen 3Q0 407 151 K  
 Volkswagen 3Q0 407 151 M  
 Volkswagen 3Q0 407 151 P  
 Volkswagen 3Q0 407 151 T  
 Volkswagen (SVW) 3QD 407 151 B

**Application info**

Audi Q3 II (F3\_) (07/18--)  
 CUPRA FORMENTOR (KM\_) (07/20--)  
 Seat Tarraco (09/18--)  
 Skoda Kodiaq I (10/16--)  
 Skoda Superb III (3V\_) (03/15--)  
 Volkswagen Arteon (03/17--)  
 Volkswagen Taos (CL1, CQ1) (10/20--)  
 Volkswagen Touran II (5T1) (05/15--)

CUPRA ATECA (KH7\_KHP) (09/18--)  
 Seat Ateca (04/16--)  
 Skoda Karoq (07/17--)  
 Skoda Kodiaq II (01/24--)  
 Skoda Superb IV (NZ\_) (11/23--)  
 Volkswagen Passat (B8) (08/14--)  
 Volkswagen Tiguan II (AD1, BW2) (01/16--)

**Control arm**

116 050 0196

MCA1166

**Notes**

Control Arm  
 Front Axle Right  
 Sheet Steel  
 with rubber mount  
 Paired article number 116 050 0195 | MCA1165  
 Required quantity 1  
 replacement in pairs recommended



**References**

Seat 3Q0 407 152 AA  
 Seat 3Q0 407 152 F  
 Seat 3Q0 407 152 T  
 Skoda 3Q0 407 152 E  
 Skoda 3Q0 407 152 J  
 Skoda 3Q0 407 152 S  
 Volkswagen 3Q0 407 152 E  
 Volkswagen 3Q0 407 152 G  
 Volkswagen 3Q0 407 152 J  
 Volkswagen 3Q0 407 152 L  
 Volkswagen 3Q0 407 152 N  
 Volkswagen 3Q0 407 152 S  
 Volkswagen (SVW) 3Q0 407 152 N  
 Volkswagen (SVW) 3QD 407 152 D

Seat 3Q0 407 152 E  
 Seat 3Q0 407 152 N  
 Skoda 3Q0 407 152 AA  
 Skoda 3Q0 407 152 F  
 Skoda 3Q0 407 152 P  
 Volkswagen 3Q0 407 152 AA  
 Volkswagen 3Q0 407 152 F  
 Volkswagen 3Q0 407 152 H  
 Volkswagen 3Q0 407 152 K  
 Volkswagen 3Q0 407 152 M  
 Volkswagen 3Q0 407 152 P  
 Volkswagen 3Q0 407 152 T  
 Volkswagen (SVW) 3QD 407 152 B

**Application info**

- |                                      |   |
|--------------------------------------|---|
| Audi Q3 II (F3_) (07/18--)           | CUPRA ATECA (KH7_KHP) (09/18--)           |
| CUPRA FORMENTOR (KM_) (07/20--)      | Seat Ateca (04/16--)                      |
| Seat Tarraco (09/18--)               | Skoda Karoq (07/17--)                     |
| Skoda Kodiaq I (10/16--)             | Skoda Kodiaq II (01/24--)                 |
| Skoda Superb III (3V_) (03/15--)     | Skoda Superb IV (NZ_) (11/23--)           |
| Volkswagen Arteon (03/17--)          | Volkswagen Passat (B8) (08/14--)          |
| Volkswagen Taos (CL1, CQ1) (10/20--) | Volkswagen Tiguan II (AD1, BW2) (01/16--) |
| Volkswagen Touran II (5T1) (05/15--) |   |

**Control arm**

116 050 0197

MCA1063

**Notes**

Control Arm  
 Front Axle Left  
 Sheet Steel  
 with rubber mount  
 without ball joint

Article number of recommended accessory 100 654 0008  
 Paired article number 116 050 0198 | MCA1064  
 Required quantity 1  
 replacement in pairs recommended



**References**

- |                           |                                 |
|---------------------------|---------------------------------|
| Audi 1K0 407 151 AA       | Audi 1K0 407 151 AB             |
| Audi 1K0 407 151 AE       | Audi 1K0 407 151 AH             |
| Audi 1K0 407 151 BC       | Audi 1K0 407 151 BD             |
| Audi 1K0 407 151 N        | Audi 1K0 407 151 P              |
| Seat 1K0 407 151 AA       | Seat 1K0 407 151 AB             |
| Seat 1K0 407 151 AE       | Seat 1K0 407 151 AH             |
| Seat 1K0 407 151 BC       | Seat 1K0 407 151 BD             |
| Seat 1K0 407 151 N        | Seat 1K0 407 151 P              |
| Skoda 1K0 407 151 AA      | Skoda 1K0 407 151 AB            |
| Skoda 1K0 407 151 AE      | Skoda 1K0 407 151 AH            |
| Skoda 1K0 407 151 BC      | Skoda 1K0 407 151 N             |
| Skoda 1K0 407 151 P       | Skoda (SVW) 1K0 407 151 BC      |
| Volkswagen 1K0 407 151 AA | Volkswagen 1K0 407 151 AB       |
| Volkswagen 1K0 407 151 AE | Volkswagen 1K0 407 151 AH       |
| Volkswagen 1K0 407 151 BC | Volkswagen 1K0 407 151 BD       |
| Volkswagen 1K0 407 151 N  | Volkswagen 1K0 407 151 P        |
| Volkswagen 2K0 407 151 B  | Volkswagen (FAW) 1K0 407 151 AA |

**Application info**

- Audi A3 II (8P\_) (05/03-12/15)
- Skoda Octavia II (1Z\_) (02/04-06/13)
- Skoda Yeti (5L) (05/09-12/17)
- Volkswagen Caddy III (2KA, 2KB) (03/04-05/15)
- Volkswagen Golf V (1K1, 1K5, 5M1) (10/03-08/14)
- Volkswagen Jetta III (1K2) (09/04-12/13)
- Volkswagen Touran I (1T1/2/3) (02/03-05/15)
- Seat Leon II / Toledo III / Altea (1P\_ ,5P\_) (03/04--)
- Skoda Superb II (3T) (03/08-05/15)
- Vauxhall Movano Mk I (10/98-12/10)
- Volkswagen Eos (03/06-08/15)
- Volkswagen Golf VI (5K1, 517, AJ5) (10/08-05/16)
- Volkswagen Scirocco III (137) (05/08-11/17)

**Control arm**

116 050 0198

MCA1064

**Notes**

Control Arm  
 Front Axle Right  
 Sheet Steel  
 with rubber mount  
 without ball joint

Article number of recommended accessories: 100 654 0008  
 Paired article number: 116 050 0197 | MCA1063  
 Required quantity: 1  
 replacement in pairs recommended



**References**

- Audi 1K0 407 152 AA
- Audi 1K0 407 152 AE
- Audi 1K0 407 152 BC
- Audi 1K0 407 152 N
- Seat 1K0 407 152 AA
- Seat 1K0 407 152 AE
- Seat 1K0 407 152 BC
- Seat 1K0 407 152 N
- Skoda 1K0 407 152 AA
- Skoda 1K0 407 152 AE
- Skoda 1K0 407 152 BC
- Skoda 1K0 407 152 P
- Volkswagen 1K0 407 152 AA
- Volkswagen 1K0 407 152 AE
- Volkswagen 1K0 407 152 BC
- Volkswagen 1K0 407 152 N
- Volkswagen 2K0 407 152 B
- Audi 1K0 407 152 AB
- Audi 1K0 407 152 AH
- Audi 1K0 407 152 BD
- Audi 1K0 407 152 P
- Seat 1K0 407 152 AB
- Seat 1K0 407 152 AH
- Seat 1K0 407 152 BD
- Seat 1K0 407 152 P
- Skoda 1K0 407 152 AB
- Skoda 1K0 407 152 AH
- Skoda 1K0 407 152 N
- Skoda (SVW) 1K0 407 152 BC
- Volkswagen 1K0 407 152 AB
- Volkswagen 1K0 407 152 AH
- Volkswagen 1K0 407 152 BD
- Volkswagen 1K0 407 152 P
- Volkswagen (FAW) 1K0 407 152 AA



**Application info**

- |   |  |
|---|--|
| Audi A3 II (8P_) (05/03-12/15)                  | Seat Leon II / Toledo III / Altea (1P_ ,5P_) (03/04--) |
| Skoda Octavia II (1Z_) (02/04-06/13)            | Skoda Superb II (3T) (03/08-05/15)                     |
| Skoda Yeti (5L) (05/09-12/17)                   | Vauxhall Movano Mk I (10/98-12/10)                     |
| Volkswagen Caddy III (2KA, 2KB) (03/04-05/15)   | Volkswagen Eos (03/06-08/15)                           |
| Volkswagen Golf V (1K1, 1K5, 5M1) (10/03-08/14) | Volkswagen Golf VI (5K1, 517, AJ5) (10/08-05/16)       |
| Volkswagen Jetta III (1K2) (09/04-12/13)        | Volkswagen Scirocco III (137) (05/08-11/17)            |
| Volkswagen Touran I (1T1/2/3) (02/03-05/15)     |  |

**Control arm**

116 050 0199

MCA1065

**Notes**

Cast Steel  
Control Arm  
Front Axle Left  
with rubber mount  
without ball joint

Article number of recommended accessories 100 654 0008  
Paired article number 116 050 0200 | MCA1066  
Required quantity 1  
replacement in pairs recommended



**References**

- |                          |                           |
|--------------------------|---------------------------|
| Audi 1K0 407 151 AC      | Audi 1K0 407 151 AD       |
| Audi 1K0 407 151 AK      | Audi 1K0 407 151 BF       |
| Seat 1K0 407 151 AC      | Seat 1K0 407 151 AD       |
| Seat 1K0 407 151 AK      | Seat 1K0 407 151 BF       |
| Seat 1K0 407 151 R       | Skoda 1K0 407 151 AC      |
| Skoda 1K0 407 151 T      | Volkswagen 1K0 407 151 AC |
| Volkswagen 1K0 407 151 M | Volkswagen 1K0 407 151 R  |

**Application info**

- |   |  |
|---|--|
| Audi A3 II (8P_) (05/03-12/15)                  | Seat Leon II / Toledo III / Altea (1P_ ,5P_) (03/04--) |
| Skoda Octavia II (1Z_) (02/04-06/13)            | Skoda Superb II (3T) (03/08-05/15)                     |
| Volkswagen Caddy III (2KA, 2KB) (03/04-05/15)   | Volkswagen Eos (03/06-08/15)                           |
| Volkswagen Golf V (1K1, 1K5, 5M1) (10/03-08/14) | Volkswagen Golf VI (5K1, 517, AJ5) (10/08-05/16)       |
| Volkswagen Jetta III (1K2) (09/04-12/13)        | Volkswagen Scirocco III (137) (05/08-11/17)            |
| Volkswagen Touran I (1T1/2/3) (02/03-05/15)     |  |



**Control arm**

116 050 0200

MCA1066

**Notes**

Cast Steel  
Control Arm  
Front Axle Right  
with rubber mount  
without ball joint

Article number of recommended accessory: 100 654 0008  
Paired article number: 116 050 0199 | MCA1065  
Required quantity: 1  
replacement in pairs recommended



**References**

- |                          |                           |
|--------------------------|---------------------------|
| Audi 1K0 407 152 AC      | Audi 1K0 407 152 AD       |
| Audi 1K0 407 152 AK      | Audi 1K0 407 152 BF       |
| Seat 1K0 407 152 AC      | Seat 1K0 407 152 AD       |
| Seat 1K0 407 152 AK      | Seat 1K0 407 152 BF       |
| Seat 1K0 407 152 R       | Skoda 1K0 407 152 AC      |
| Skoda 1K0 407 152 T      | Volkswagen 1K0 407 152 AC |
| Volkswagen 1K0 407 152 M | Volkswagen 1K0 407 152 R  |

**Application info**

- |   |  |
|---|--|
| Audi A3 II (8P_) (05/03-12/15)                  | Seat Leon II / Toledo III / Altea (1P_ ,5P_) (03/04--) |
| Skoda Octavia II (1Z_) (02/04-06/13)            | Skoda Superb II (3T) (03/08-05/15)                     |
| Volkswagen Caddy III (2KA, 2KB) (03/04-05/15)   | Volkswagen Eos (03/06-08/15)                           |
| Volkswagen Golf V (1K1, 1K5, 5M1) (10/03-08/14) | Volkswagen Golf VI (5K1, 517, AJ5) (10/08-05/16)       |
| Volkswagen Jetta III (1K2) (09/04-12/13)        | Volkswagen Scirocco III (137) (05/08-11/17)            |
| Volkswagen Touran I (1T1/2/3) (02/03-05/15)     |  |

**Control arm**

116 050 0201/HD

MCA1261HD

**Notes**

Aluminium  
Carbon Neutral  
Control Arm  
Front  
Front Axle Left  
Lower

Paired article number: 116 050 0202/HD | MCA1262HD  
Replace in pairs only  
Required quantity: 1  
reinforced version



**References**

Audi 4H0 407 151 A  
Audi 4H0 407 151 C

Audi 4H0 407 151 B  
Audi 4H0 407 155 A

**Application info**

Audi A8 III (4H\_) (11/09-01/18)

**Control arm**

116 050 0202/HD

MCA1262HD

**Notes**

Aluminium  
Carbon Neutral  
Control Arm  
Front  
Front Axle Right  
Lower

Paired article number  
Replace in pairs only  
Required quantity  
reinforced version

116 050 0201/HD | MCA1261HD

1



**References**

Audi 4H0 407 152 A  
Audi 4H0 407 152 C

Audi 4H0 407 152 B  
Audi 4H0 407 156 A

**Application info**

Audi A8 III (4H\_) (11/09-01/18)

**Control arm**

116 050 0203

MCA1067

**Notes**

Aluminium  
Control Arm  
Front  
Front Axle Left  
Front Axle Right  
Lower  
with accessories  
with rubber mount

Cone Size [mm]

16

Length [mm]

364

Required quantity

2

replacement in pairs recommended



**References**

Audi 8E0 407 151 E

Audi 8E0 407 151 L

Audi 8E0 407 151 N

Audi (FAW) 8E0 407 151 M

Seat 8E0 407 151 R

Audi 8E0 407 151 K

Audi 8E0 407 151 M

Audi 8E0 407 151 R

Audi (FAW) 8E0 407 151 R

**Application info**

Audi A4 Cabriolet (8H\_) (01/02-12/09)

Audi A4 III (8E\_) (11/04-06/08)

Audi A4 II (8E\_) (02/00-12/05)

Seat Exeo (3R) (12/08-05/13)

**Control arm****116 050 0205****MCA1068****Notes**

Aluminium  
Control Arm  
Front  
Front Axle Left  
Front Axle Right  
Lower  
with accessories  
with rubber mount

Length [mm]

365

Required quantity

2

replacement in pairs recommended

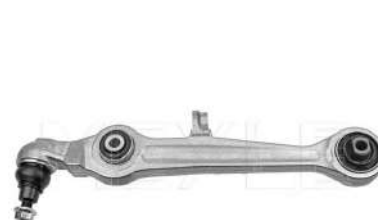
**References**

Audi 4D0 407 151 H

Audi 8D0 407 151 E

Skoda 4D0 407 151 P

Volkswagen 4D0 407 151 B

Volkswagen 4D0 407 151 E

Volkswagen 4D0 407 151 H

Volkswagen 4D0 407 151 P

Volkswagen (SVW) 4D0 407 151 P

Audi 4D0 407 151 P

Audi (FAW) 4D0 407 151 P

Skoda 8D0 407 151 E

Volkswagen 4D0 407 151 C

Volkswagen 4D0 407 151 G

Volkswagen 4D0 407 151 J

Volkswagen 8D0 407 151 E

**Application info**

Audi A4 I (8D\_) (11/94-12/02)

Audi A8 I (4D\_) (03/94-12/05)

Volkswagen Passat (3B\_) (08/96-12/05)

Audi A6 II (4B, C5) (01/97-12/05)

Skoda Superb I (3U) (12/01-03/08)

## Control arm

116 050 0206

MCA1069

## Notes

Aluminium  
Control Arm  
Front Axle Right  
Rear  
Upper  
with rubber mount

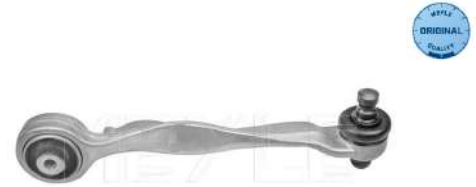

Length [mm]

248

Paired article number

116 050 0207 | MCA1070

Required quantity

1

replacement in pairs recommended

## References

Audi 4D0 407 510 B

Audi 4D0 407 510 F

Audi 4D0 407 510 H

Audi 4D0 407 510 K

Audi 8D0 407 510 C

Audi 8D0 407 510 F

Audi 8E0 407 510 A

Audi 8E0 407 510 E

Audi 8E0 407 510 Q

Audi (FAW) 8E0 407 510 C

Seat 8E0 407 510 P

Skoda 8E0 407 510 A

Volkswagen 4D0 407 510 D

Volkswagen 4D0 407 510 G

Volkswagen 4D0 407 510 J

Volkswagen 8D0 407 510 C

Volkswagen 8D0 407 510 F

Volkswagen 8E0 407 510 A

Volkswagen (SVW) 8D0 407 510 C

Volkswagen (SVW) 8E0 407 510 A

Audi 4D0 407 510 D

Audi 4D0 407 510 G

Audi 4D0 407 510 J

Audi 8D0 407 510 A

Audi 8D0 407 510 E

Audi 8D0 407 510 G

Audi 8E0 407 510 C

Audi 8E0 407 510 P

Audi (FAW) 8E0 407 510 A

Audi (FAW) 8E0 407 510 P

Skoda 8D0 407 510 G

Volkswagen 4D0 407 510 B

Volkswagen 4D0 407 510 F

Volkswagen 4D0 407 510 H

Volkswagen 8D0 407 510 A

Volkswagen 8D0 407 510 E

Volkswagen 8D0 407 510 G

Volkswagen 8E0 407 510 C

Volkswagen (SVW) 8D0 407 510 E

Volkswagen (SVW) 8ED 407 510

## Application info

Audi A4 Cabriolet (8H\_) (01/02-12/09)

Audi A4 II (8E\_) (02/00-12/05)

Audi A6 II (4B, C5) (01/97-12/05)

Audi Allroad (4BH) (05/00-08/05)

Skoda Superb I (3U) (12/01-03/08)

Audi A4 I (8D\_) (11/94-12/02)

Audi A4 III (8E\_) (11/04-06/08)

Audi A8 I (4D\_) (03/94-12/05)

Seat Exeo (3R) (12/08-05/13)

Volkswagen Passat (3B\_) (08/96-12/05)

## Control arm

116 050 0207

MCA1070

## Notes

Aluminium  
Control Arm  
Front Axle Left  
Rear  
Upper  
with rubber mount

Length [mm]

248

Paired article number

116 050 0206 | MCA1069

Required quantity

1

replacement in pairs recommended



## References

Audi 4D0 407 509 B

Audi 4D0 407 509 D

Audi 4D0 407 509 F

Audi 4D0 407 509 G

Audi 4D0 407 509 H

Audi 4D0 407 509 J

Audi 4D0 407 509 K

Audi 8D0 407 509 A

Audi 8D0 407 509 C

Audi 8D0 407 509 E

Audi 8D0 407 509 F

Audi 8D0 407 509 G

Audi 8E0 407 509 A

Audi 8E0 407 509 C

Audi 8E0 407 509 E

Audi 8E0 407 509 P

Audi 8E0 407 509 Q

Audi (FAW) 8E0 407 509 A

Audi (FAW) 8E0 407 509 C

Audi (FAW) 8E0 407 509 P

Seat 8E0 407 509 P

Skoda 4D0 407 509 G

Skoda 8E0 407 509 A

Volkswagen 4D0 407 509 B

Volkswagen 4D0 407 509 D

Volkswagen 4D0 407 509 F

Volkswagen 4D0 407 509 G

Volkswagen 4D0 407 509 H

Volkswagen 4D0 407 509 J

Volkswagen 8D0 407 509 A

Volkswagen 8D0 407 509 C

Volkswagen 8D0 407 509 E

Volkswagen 8D0 407 509 F

Volkswagen 8D0 407 509 G

Volkswagen 8E0 407 509 A

Volkswagen 8E0 407 509 C

Volkswagen (SVW) 8D0 407 509 C

Volkswagen (SVW) 8D0 407 509 E

Volkswagen (SVW) 8E0 407 509 A

Volkswagen (SVW) 8ED 407 509

## Application info

Audi A4 Cabriolet (8H\_) (01/02-12/09)

Audi A4 I (8D\_) (11/94-12/02)

Audi A4 II (8E\_) (02/00-12/05)

Audi A4 III (8E\_) (11/04-06/08)

Audi A6 II (4B, C5) (01/97-12/05)

Audi A8 I (4D\_) (03/94-12/05)

Audi Allroad (4BH) (05/00-08/05)

Seat Exeo (3R) (12/08-05/13)

Skoda Superb I (3U) (12/01-03/08)

Volkswagen Passat (3B\_) (08/96-12/05)

## Control arm

116 050 0208

MCA1071

## Notes

Aluminium  
Control Arm  
Front  
Front Axle Right  
Upper  
with rubber mount

Length [mm]

273

Paired article number

116 050 0209 | MCA1072

Required quantity

1

replacement in pairs recommended



## References

Audi 8D0 407 506 E

Audi 8E0 407 506 A

Audi 8E0 407 506 C

Audi 8E0 407 506 E

Audi 8E0 407 506 P

Audi 8E0 407 506 Q

Audi (FAW) 8E0 407 506 A

Audi (FAW) 8E0 407 506 C

Audi (FAW) 8E0 407 506 P

Seat 8E0 407 506 P

Skoda 8E0 407 506 A

Skoda 8E0 407 506 P

Volkswagen 4Z7 407 506 A

Volkswagen 8D0 407 506 B

Volkswagen 8D0 407 506 C

Volkswagen 8D0 407 506 D

Volkswagen 8D0 407 506 E

Volkswagen 8D0 407 506 F

Volkswagen 8D0 407 506 H

Volkswagen 8D0 407 506 K

Volkswagen 8D0 407 506 L

Volkswagen 8D0 407 508 E

Volkswagen 8E0 407 506 A

Volkswagen 8E0 407 506 C

Volkswagen 8E0 407 506 P

Volkswagen (SVW) 8E0 407 506 A

## Application info

Audi A4 Cabriolet (8H\_) (01/02-12/09)

Audi A4 I (8D\_) (11/94-12/02)

Audi A4 II (8E\_) (02/00-12/05)

Audi A4 III (8E\_) (11/04-06/08)

Audi A6 II (4B, C5) (01/97-12/05)

Audi Allroad (4BH) (05/00-08/05)

Seat Exeo (3R) (12/08-05/13)

Skoda Superb I (3U) (12/01-03/08)

Volkswagen Passat (3B\_) (08/96-12/05)

## Control arm

116 050 0209

MCA1072

## Notes

Aluminium  
Control Arm  
Front  
Front Axle Left  
Upper  
with rubber mount

Length [mm]

273

Paired article number

116 050 0208 | MCA1071

Required quantity

1

replacement in pairs recommended



## References

Audi 8D0 407 505 E

Audi 8E0 407 505 C

Audi 8E0 407 505 P

Audi (FAW) 8E0 407 505 A

Audi (FAW) 8E0 407 505 P

Skoda 8E0 407 505 A

Volkswagen 4Z7 407 505 A

Volkswagen 8D0 407 505 C

Volkswagen 8D0 407 505 F

Volkswagen 8D0 407 505 K

Volkswagen 8D0 407 507 E

Volkswagen 8E0 407 505 C

Volkswagen (SVW) 8E0 407 505 A

Audi 8E0 407 505 A

Audi 8E0 407 505 E

Audi 8E0 407 505 Q

Audi (FAW) 8E0 407 505 C

Seat 8E0 407 505 P

Skoda 8E0 407 505 P

Volkswagen 8D0 407 505 B

Volkswagen 8D0 407 505 E

Volkswagen 8D0 407 505 H

Volkswagen 8D0 407 505 L

Volkswagen 8E0 407 505 A

Volkswagen 8E0 407 505 P

Volkswagen (SVW) 8ED 407 505

## Application info

Audi A4 Cabriolet (8H\_) (01/02-12/09)

Audi A4 II (8E\_) (02/00-12/05)

Audi A6 II (4B, C5) (01/97-12/05)

Seat Exeo (3R) (12/08-05/13)

Volkswagen Passat (3B\_) (08/96-12/05)

Audi A4 I (8D\_) (11/94-12/02)

Audi A4 III (8E\_) (11/04-06/08)

Audi Allroad (4BH) (05/00-08/05)

Skoda Superb I (3U) (12/01-03/08)

## Control arm

116 050 0210

MCA1073

## Notes

Aluminium  
Control Arm  
Front Axle Right  
Lower  
Rear  
with accessories  
with rubber mount



Length [mm]

383

Paired article number

116 050 0211 | MCA1074

Required quantity

1

replacement in pairs recommended

## References

Audi 4D0 407 694 AC

Audi 4D0 407 694 E

Audi 4D0 407 694 H

Audi 4D0 407 694 M

Audi 4D0 407 696 J

Audi 8E0 407 694 K

Audi (FAW) 8E0 407 694 AG

Skoda 8E0 407 694 AG

Volkswagen 4D0 407 694 N

Volkswagen 8E0 407 694 AG

Volkswagen 8E0 407 694 H

Volkswagen 8E0 407 694 P

Audi 4D0 407 694 AD

Audi 4D0 407 694 G

Audi 4D0 407 694 K

Audi 4D0 407 694 P

Audi 8E0 407 694 AG

Audi 8E0 407 694 Q

Audi (FAW) 8E0 407 694 Q

Skoda 8E0 407 694 Q

Volkswagen 8E0 407 694

Volkswagen 8E0 407 694 E

Volkswagen 8E0 407 694 K

Volkswagen 8E0 407 694 Q

## Application info

Audi A4 Cabriolet (8H\_) (01/02-12/09)

Audi A4 II (8E\_) (02/00-12/05)

Audi A6 II (4B, C5) (01/97-12/05)

Skoda Superb I (3U) (12/01-03/08)

Audi A4 I (8D\_) (11/94-12/02)

Audi A4 III (8E\_) (11/04-06/08)

Audi A8 I (4D\_) (03/94-12/05)

Volkswagen Passat (3B\_) (08/96-12/05)



## Control arm

116 050 0211

MCA1074

## Notes

Aluminium  
Control Arm  
Front Axle Left  
Lower  
Rear  
with accessories  
with rubber mount



Length [mm]

383

Paired article number

116 050 0210 | MCA1073

Required quantity

1

replacement in pairs recommended

## References

Audi 4D0 407 693 AC

Audi 4D0 407 693 E

Audi 4D0 407 693 H

Audi 4D0 407 693 M

Audi 4D0 407 695 J

Audi 8E0 407 693 K

Audi (FAW) 8E0 407 693 AG

Skoda 8E0 407 693 AG

Volkswagen 4D0 407 693 N

Volkswagen 8E0 407 693 AG

Volkswagen 8E0 407 693 H

Volkswagen 8E0 407 693 P

Audi 4D0 407 693 AD

Audi 4D0 407 693 G

Audi 4D0 407 693 K

Audi 4D0 407 693 P

Audi 8E0 407 693 AG

Audi 8E0 407 693 Q

Audi (FAW) 8E0 407 693 Q

Skoda 8E0 407 693 Q

Volkswagen 8E0 407 693

Volkswagen 8E0 407 693 E

Volkswagen 8E0 407 693 K

Volkswagen 8E0 407 693 Q

## Application info

Audi A4 Cabriolet (8H\_) (01/02-12/09)

Audi A4 II (8E\_) (02/00-12/05)

Audi A6 II (4B, C5) (01/97-12/05)

Skoda Superb I (3U) (12/01-03/08)

Audi A4 I (8D\_) (11/94-12/02)

Audi A4 III (8E\_) (11/04-06/08)

Audi A8 I (4D\_) (03/94-12/05)

Volkswagen Passat (3B\_) (08/96-12/05)

**Control arm**

116 050 0212

MCA1075

**Notes**

Aluminium  
Control Arm  
Front  
Front Axle Left  
Front Axle Right  
Lower  
with rubber mount

Cone Size [mm] 16  
Length [mm] 365  
Required quantity 2  
replacement in pairs recommended



**References**





Audi 4B0 407 151  
Audi 4B3 407 151 C  
Audi 4B3 407 151 F  
Audi (FAW) 4B0 407 151  
Audi (FAW) 4B3 407 151 F  
Skoda 4B0 407 151  
Skoda 4B3 407 151 C  
Skoda 4B3 407 151 F  
Volkswagen 4B0 407 151  
Volkswagen 4B3 407 151 C  
Volkswagen 4B3 407 151 F  
Volkswagen (SVW) 4B3 407 151 K

Audi 4B3 407 151 A  
Audi 4B3 407 151 E  
Audi 4B3 407 151 K  
Audi (FAW) 4B3 407 151 C  
Audi (FAW) 4B3 407 151 K  
Skoda 4B3 407 151 A  
Skoda 4B3 407 151 E  
Skoda 4B3 407 151 K  
Volkswagen 4B3 407 151 A  
Volkswagen 4B3 407 151 E  
Volkswagen 4B3 407 151 K

**Application info**

Audi A4 I (8D\_) (11/94-12/02)  
Audi A8 I (4D\_) (03/94-12/05)  
Volkswagen Passat (3B\_) (08/96-12/05)

Audi A6 II (4B, C5) (01/97-12/05)  
Skoda Superb I (3U) (12/01-03/08)

Control arm		116 050 0213	MCA1076
<b>Notes</b>  Aluminium Control Arm Front Front Axle Left Upper with rubber mount  Length [mm] 301 Paired article number 116 050 0214   MCA1077 Required quantity 1 replacement in pairs recommended		 	
<b>References</b> Audi 4E0 407 505 B Audi 4E0 407 505 E Audi 4E0 407 505 F Audi (FAW) 4E0 407 505 B Audi (FAW) 4E0 407 505 E Audi (FAW) L4E0 407 505 B Volkswagen 4E0 407 505 B Volkswagen 4E0 407 505 E			
<b>Application info</b> Audi A6 III (4F2, 4FH, 4F5) (04/04-08/11) Audi A8 II (4E_) (10/02-12/10) Volkswagen Phaeton (3D) (04/02-03/16)			
Control arm		116 050 0214	MCA1077
<b>Notes</b>  Aluminium Control Arm Front Front Axle Right Upper with rubber mount  Length [mm] 301 Paired article number 116 050 0213   MCA1076 Required quantity 1 replacement in pairs recommended		 	
<b>References</b> Audi 4E0 407 506 B Audi 4E0 407 506 E Audi 4E0 407 506 F Audi (FAW) 4E0 407 506 B Audi (FAW) 4E0 407 506 E Audi (FAW) L4E0 407 506 B Volkswagen 4E0 407 506 B Volkswagen 4E0 407 506 E			

**Application info**

Audi A6 III (4F2, 4FH, 4F5) (04/04-08/11)  
 Volkswagen Phaeton (3D) (04/02-03/16)

Audi A8 II (4E\_) (10/02-12/10)

**Control arm**

116 050 0215

MCA1078

**Notes**

Control Arm  
 Front Axle Left  
 Sheet Steel  
 with ball joint  
 with rubber mount

Article number of recommended accessories: 100 654 0008  
 Paired article number: 116 050 0216 | MCA1079  
 Required quantity: 1  
 replacement in pairs recommended



**References**

- |                                |                                 |
|--------------------------------|---------------------------------|
| Audi 1K0 407 151 AA            | Audi 1K0 407 151 AB             |
| Audi 1K0 407 151 AE            | Audi 1K0 407 151 AH             |
| Audi 1K0 407 151 BC            | Audi 1K0 407 151 BD             |
| Audi 1K0 407 151 N             | Audi 1K0 407 151 P              |
| Seat 1K0 407 151 AA            | Seat 1K0 407 151 AB             |
| Seat 1K0 407 151 AE            | Seat 1K0 407 151 AH             |
| Seat 1K0 407 151 BC            | Seat 1K0 407 151 BD             |
| Seat 1K0 407 151 N             | Seat 1K0 407 151 P              |
| Skoda 1K0 407 151 AA           | Skoda 1K0 407 151 AB            |
| Skoda 1K0 407 151 AE           | Skoda 1K0 407 151 AH            |
| Skoda 1K0 407 151 BC           | Skoda 1K0 407 151 N             |
| Skoda 1K0 407 151 P            | Skoda (SVW) 1K0 407 151 BC      |
| Volkswagen 1K0 407 151 AA      | Volkswagen 1K0 407 151 AB       |
| Volkswagen 1K0 407 151 AE      | Volkswagen 1K0 407 151 AH       |
| Volkswagen 1K0 407 151 BC      | Volkswagen 1K0 407 151 BD       |
| Volkswagen 1K0 407 151 N       | Volkswagen 1K0 407 151 P        |
| Volkswagen 2K0 407 151 B       | Volkswagen (FAW) 1K0 407 151 AA |
| Volkswagen (FAW) 1K0 407 151 P |                                 |

**Application info**

- Audi A3 II (8P\_) (05/03-12/15)
- Skoda Octavia II (1Z\_) (02/04-06/13)
- Skoda Superb II (3T) (03/08-05/15)
- Volkswagen Caddy III (2KA, 2KB) (03/04-05/15)
- Volkswagen Golf V (1K1, 1K5, 5M1) (10/03-08/14)
- Volkswagen Jetta III (1K2) (09/04-12/13)
- Volkswagen Touran I (1T1/2/3) (02/03-05/15)
- Seat Leon II / Toledo III / Altea (1P\_ ,5P\_) (03/04--)
- Skoda Roomster (03/06-05/15)
- Skoda Yeti (5L) (05/09-12/17)
- Volkswagen Eos (03/06-08/15)
- Volkswagen Golf VI (5K1, 517, AJ5) (10/08-05/16)
- Volkswagen Scirocco III (137) (05/08-11/17)

**Control arm**

**116 050 0216 MCA1079**

**Notes**

Control Arm  
 Front Axle Right  
 Sheet Steel  
 with ball joint  
 with rubber mount

Article number of recommended accessories: 100 654 0008  
 Paired article number: 116 050 0215 | MCA1078  
 Required quantity: 1  
 replacement in pairs recommended



**References**

- Audi 1K0 407 152 AA
- Audi 1K0 407 152 AE
- Audi 1K0 407 152 BC
- Audi 1K0 407 152 N
- Seat 1K0 407 152 AA
- Seat 1K0 407 152 AE
- Seat 1K0 407 152 BC
- Seat 1K0 407 152 N
- Skoda 1K0 407 152 AA
- Skoda 1K0 407 152 AE
- Skoda 1K0 407 152 BC
- Skoda 1K0 407 152 P
- Volkswagen 1K0 407 152 AB
- Volkswagen 1K0 407 152 AH
- Volkswagen 1K0 407 152 BD
- Volkswagen 1K0 407 152 P
- Volkswagen (FAW) 1K0 407 152 AA
- Audi 1K0 407 152 AB
- Audi 1K0 407 152 AH
- Audi 1K0 407 152 BD
- Audi 1K0 407 152 P
- Seat 1K0 407 152 AB
- Seat 1K0 407 152 AH
- Seat 1K0 407 152 BD
- Seat 1K0 407 152 P
- Skoda 1K0 407 152 AB
- Skoda 1K0 407 152 AH
- Skoda 1K0 407 152 N
- Volkswagen 1K0 407 152 AA
- Volkswagen 1K0 407 152 AE
- Volkswagen 1K0 407 152 BC
- Volkswagen 1K0 407 152 N
- Volkswagen 2K0 407 152 B
- Volkswagen (FAW) 1K0 407 152P

**Application info**

Audi A3 II (8P_) (05/03-12/15)	Seat Leon II / Toledo III / Altea (1P_ ,5P_) (03/04--)
Skoda Octavia II (1Z_) (02/04-06/13)	Skoda Roomster (03/06-05/15)
Skoda Superb II (3T) (03/08-05/15)	Skoda Yeti (5L) (05/09-12/17)
Volkswagen Caddy III (2KA, 2KB) (03/04-05/15)	Volkswagen Eos (03/06-08/15)
Volkswagen Golf V (1K1, 1K5, 5M1) (10/03-08/14)	Volkswagen Golf VI (5K1, 517, AJ5) (10/08-05/16)
Volkswagen Jetta III (1K2) (09/04-12/13)	Volkswagen Scirocco III (137) (05/08-11/17)
Volkswagen Touran I ( 1T1/2/3) (02/03-05/15)	

**Control arm**

116 050 0217

MCA1176

**Notes**

Front  
 Lower  
 Rear Axle Left  
 Sheet Steel  
 Trailing Arm

Paired article number  
 Required quantity  
 replacement in pairs recommended

116 050 0218 | MCA1177  
 1



**References**

Skoda 3Q0 505 223	Skoda 3Q0 505 223 A
Volkswagen 3Q0 505 223	Volkswagen 3Q0 505 223 A
Volkswagen 3Q0 505 225	

**Application info**

Skoda Superb III (3V_) (03/15--)	Volkswagen Arteon (03/17--)
Volkswagen Passat (B8) (08/14--)	

**Control arm**

116 050 0218

MCA1177

**Notes**

Front  
 Lower  
 Rear Axle Right  
 Sheet Steel  
 Trailing Arm

Paired article number  
 Required quantity  
 replacement in pairs recommended

116 050 0217 | MCA1176  
 1



**References**

Skoda 3Q0 505 224  
Volkswagen 3Q0 505 224

Skoda 3Q0 505 224 A  
Volkswagen 3Q0 505 224 A

**Application info**

Skoda Superb III (3V\_) (03/15--)  
Volkswagen Passat (B8) (08/14--)

Volkswagen Arteon (03/17--)

**Control arm**

116 050 0220/HD

MCA1153HD

**Notes**

Aluminium  
Carbon Neutral  
Control Arm  
Front Axle Right  
Lower  
Rear  
outer

Paired article number  
Replace in pairs only  
Required quantity  
reinforced version

116 050 0221/HD | MCA1154HD

1



**References**

Audi 4H0 407 694 C  
Audi 4H0 407 694 E  
Audi 4H0 407 694 G

Audi 4H0 407 694 D  
Audi 4H0 407 694 F

**Application info**

Audi A8 III (4H\_) (11/09-01/18)

**Control arm**

116 050 0221/HD

MCA1154HD

**Notes**

Aluminium  
Carbon Neutral  
Control Arm  
Front Axle Left  
Lower  
Rear  
outer

Paired article number  
Replace in pairs only  
Required quantity  
reinforced version

116 050 0220/HD | MCA1153HD

1



**References**

Audi 4H0 407 693 C  
 Audi 4H0 407 693 E  
 Audi 4H0 407 693 G

Audi 4H0 407 693 D  
 Audi 4H0 407 693 F

**Application info**

Audi A8 III (4H\_) (11/09-01/18)

**Control arm****116 050 0224/HD****MCA1128HD****Notes**

Aluminium  
 Carbon Neutral  
 Control Arm  
 Front  
 Front Axle Left  
 Lower  
 with fastening material  
 with rubber mount

Bore Diameter [mm]

17

Paired article number

116 050 0225/HD | MCA1129HD

Replace in pairs only

Required quantity

1

reinforced version

**References**

Audi 8K0 407 151 F  
 Audi (FAW) 8KD 407 151 B  
 Porsche 8K0 407 151 G

Audi 8K0 407 151 G  
 Porsche 8K0 407 151 F

**Application info**

Audi A4 IV (8K\_) (08/07-05/16)  
 Audi A6 IV (4G2, 4G5, C7) (11/10-09/18)  
 Audi Q5 I (8R\_) (11/08-12/17)

Audi A5 I (8F\_ , 8T\_) (06/07-01/17)  
 Audi A7 I Sportback (4G\_) (07/10-05/18)  
 Porsche Macan (95B) (02/14--)



## Control arm

116 050 0224

MCA1128

## Notes

Aluminium  
Control Arm  
Front  
Front Axle Left  
Lower  
without ball joint

Paired article number 116 050 0225 | MCA1129  
Replace in pairs only  
Required quantity 1  
replacement in pairs recommended



## References

Audi 8K0 407 151 F Audi 8K0 407 151 G  
Audi (FAW) 8KD 407 151 B Porsche 8K0 407 151 F  
Porsche 8K0 407 151 G

## Application info

Audi A4 IV (8K\_) (08/07-05/16) Audi A5 I (8F\_, 8T\_) (06/07-01/17)  
Audi A6 IV (4G2, 4G5, C7) (11/10-09/18) Audi A7 I Sportback (4G\_) (07/10-05/18)  
Audi Q5 I (8R\_) (11/08-12/17) Porsche Macan (95B) (02/14--)

## Control arm

116 050 0225

MCA1129

## Notes

Aluminium  
Control Arm  
Front  
Front Axle Right  
Lower  
without ball joint

Paired article number 116 050 0224 | MCA1128  
Replace in pairs only  
Required quantity 1  
replacement in pairs recommended



## References

Audi 8K0 407 152 F Audi 8K0 407 152 G  
Audi (FAW) 8KD 407 152 B Porsche 8K0 407 152 F  
Porsche 8K0 407 152 G

**Application info**

Audi A4 IV (8K\_) (08/07-05/16)

Audi A6 IV (4G2, 4G5, C7) (11/10-09/18)

Audi Q5 I (8R\_) (11/08-12/17)

Audi A5 I (8F\_ , 8T\_) (06/07-01/17)

Audi A7 I Sportback (4G\_) (07/10-05/18)

Porsche Macan (95B) (02/14--)

**Control arm**

116 050 0225/HD

MCA1129HD

**Notes**

Aluminium  
Carbon Neutral  
Control Arm  
Front  
Front Axle Right  
Lower  
with fastening material  
with rubber mount

Bore Diameter [mm]

17

Length [mm]

351

Paired article number

116 050 0224/HD | MCA1128HD

Replace in pairs only

Required quantity

1

reinforced version



**References**

Audi 8K0 407 152 F

Audi 8K0 407 152 G

Audi (FAW) 8KD 407 152 B

Porsche 8K0 407 152 F

Porsche 8K0 407 152 G

**Application info**

Audi A4 IV (8K\_) (08/07-05/16)

Audi A5 I (8F\_ , 8T\_) (06/07-01/17)

Audi A6 IV (4G2, 4G5, C7) (11/10-09/18)

Audi A7 I Sportback (4G\_) (07/10-05/18)

Audi Q5 I (8R\_) (11/08-12/17)

Porsche Macan (95B) (02/14--)

**Control arm**

116 050 0227/HD

MCA1410HD

**Notes**

Carbon Neutral  
Control Arm  
Front Axle Left  
Steel

Paired article number

116 050 0228/HD | MCA1411HD

Replace in pairs only

Required quantity

1

reinforced version



**References**

- |                          |                          |
|--------------------------|--------------------------|
| MAN 2N0 407 151 F        | MAN 2N0 407 151 G        |
| MAN 2N0 407 151 H        | MAN 2N0 407 151 J        |
| MAN 2N0 407 151 L        | MAN 65.43315-6003        |
| MAN 65.43315-6007        | MAN 65.43315-6009        |
| MAN 65.43315.6011        | Volkswagen 2N0 407 151 F |
| Volkswagen 2N0 407 151 G | Volkswagen 2N0 407 151 H |
| Volkswagen 2N0 407 151 J | Volkswagen 2N0 407 151 L |
| Volkswagen 2N0 407 151 M | Volkswagen 2N0 407 151 P |

**Application info**

- |                   |                                       |
|-------------------|---------------------------------------|
| MAN TGE (11/16--) | Volkswagen Crafter II (SY_) (09/16--) |
|-------------------|---------------------------------------|

**Control arm**

**116 050 0228/HD MCA1411HD**

**Notes**

Carbon Neutral  
Control Arm  
Front Axle Right  
Steel  
116 050 0227/HD | MCA1410HD

- Paired article number  
Replace in pairs only  
Required quantity  
reinforced version

1





**References**

- |                          |                          |
|--------------------------|--------------------------|
| MAN 2N0 407 152 F        | MAN 2N0 407 152 G        |
| MAN 2N0 407 152 H        | MAN 2N0 407 152 J        |
| MAN 2N0 407 152 L        | MAN 65.43315-6004        |
| MAN 65.43315-6006        | MAN 65.43315-6008        |
| MAN 65.43315-6010        | Volkswagen 2N0 407 152 F |
| Volkswagen 2N0 407 152 G | Volkswagen 2N0 407 152 H |
| Volkswagen 2N0 407 152 J | Volkswagen 2N0 407 152 L |
| Volkswagen 2N0 407 152 M | Volkswagen 2N0 407 152 P |

**Application info**

- |                   |                                       |
|-------------------|---------------------------------------|
| MAN TGE (11/16--) | Volkswagen Crafter II (SY_) (09/16--) |
|-------------------|---------------------------------------|

Control arm		116 050 0235	MCA0219
<b>Notes</b>  Control Arm Front Axle Left Front Axle Right Lower Sheet Steel with rubber mount  Required quantity replacement in pairs recommended			
<b>References</b> Seat 6N0 407 151 B Volkswagen 6N0 407 151 Volkswagen 6N0 407 151 B			
<b>Application info</b> Seat Arosa (6H) (05/97-06/04) Volkswagen Polo (6N_) (09/94-10/01)			
Control arm		116 050 0237/HD	MCA1202HD
<b>Notes</b>  Carbon Neutral Control Arm Rear Axle Left Sheet Steel with fastening material with rubber mount  Paired article number Replace in pairs only Required quantity reinforced version			
Paired article number Replace in pairs only Required quantity reinforced version		116 050 0238/HD   MCA1203HD	
<b>References</b> Seat 5QF 505 223 C Skoda 5QF 505 223 C Volkswagen 5QF 505 223 C Volkswagen 5QF 505 225 C			
<b>Application info</b> Audi Q3 II (F3_) (07/18--) Seat Tarraco (09/18--) Skoda Kodiaq I (10/16--) Volkswagen Tiguan II (AD1, BW2) (01/16--)			

## Control arm

116 050 0238/HD

MCA1203HD

## Notes

Carbon Neutral  
Control Arm  
Rear Axle Right  
Sheet Steel  
with fastening material  
with rubber mount

Paired article number  
Replace in pairs only  
Required quantity  
reinforced version

116 050 0237/HD | MCA1202HD

1



## References

Audi 5QF 505 224 C  
Skoda 5QF 505 224 C

Seat 5QF 505 224 C  
Volkswagen 5QF 505 224 C

## Application info

Audi Q3 II (F3\_) (07/18--)  
Skoda Kodiaq I (10/16--)

Seat Tarraco (09/18--)  
Volkswagen Tiguan II (AD1, BW2) (01/16--)

## Control arm

116 050 0239/HD

MCA1200HD

## Notes

Carbon Neutral  
Cast Steel  
Control Arm  
Front Axle Left  
with rubber mount

Paired article number  
Replace in pairs only  
Required quantity  
reinforced version

116 050 0240/HD | MCA1201HD

1



## References





Volkswagen 7E0 407 151 B  
Volkswagen 7E0 407 165 C  
Volkswagen 7E8 407 151 B

Volkswagen 7E0 407 151 C  
Volkswagen 7E8 407 151 A

## Application info

Volkswagen Transporter V (04/03-08/15)

Volkswagen Transporter VI (04/15--)

Control arm		116 050 0240/HD	MCA1201HD
<b>Notes</b>	Carbon Neutral Cast Steel Control Arm Front Axle Right with rubber mount		
Paired article number Replace in pairs only Required quantity reinforced version	116 050 0239/HD   MCA1200HD  1		
<b>References</b>		Volkswagen 7E0 407 152 B	Volkswagen 7E8 407 152 A
<b>Application info</b>		Volkswagen Transporter V (04/03-08/15)	Volkswagen Transporter VI (04/15--)
Control arm		116 050 0243/HD	MCA1213HD
<b>Notes</b>	Aluminium Carbon Neutral Control Arm Front Axle Left Lower Rear with ball joint with rubber mount		
Paired article number Replace in pairs only Required quantity reinforced version	116 050 0244/HD   MCA1214HD  1		
<b>References</b>		Audi 8W0 407 693 A Audi 8W0 407 695 B	Audi 8W0 407 693 B Audi (FAW) 8W0 407 693 B
<b>Application info</b>		Audi A4 V (8W_) (05/15--)	Audi A5 II (F5_) (06/16--)

Control arm		116 050 0244/HD	MCA1214HD
<p><b>Notes</b></p> <p>Aluminium Carbon Neutral Control Arm Front Axle Right Lower Rear with ball joint with rubber mount</p> <p>Paired article number Replace in pairs only Required quantity reinforced version</p>	<p>116 050 0243/HD   MCA1213HD</p> <p>1</p>		

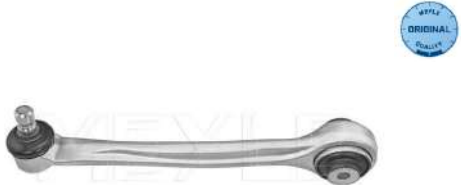

References	
Audi 8W0 407 694 A Audi (FAW) 8W0 407 694 A	Audi 8W0 407 694 B

Application info	
Audi A4 V (8W_) (05/15--)	Audi A5 II (F5_) (06/16--)

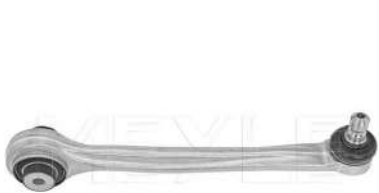

Control arm		116 050 0245	MCA1195
<p><b>Notes</b></p> <p>Aluminium Control Arm Front Front Axle Left Upper with ball joint with rubber mount</p> <p>Paired article number Required quantity replacement in pairs recommended</p>	<p>116 050 0246   MCA1196</p> <p>1</p>		

References	
Audi 8W0 407 505 A Audi 8W0 407 505 E	Audi 8W0 407 505 C Audi (FAW) 8W0 407 505 A

Application info	
Audi A4 V (8W_) (05/15--)	Audi A5 II (F5_) (06/16--)

Control arm		116 050 0246	MCA1196
<p><b>Notes</b></p> <p>Aluminium Control Arm Front Front Axle Right Upper with ball joint with rubber mount</p> <p>Paired article number Required quantity replacement in pairs recommended</p>			
<p><b>References</b></p> <p>Audi 8W0 407 506 A Audi 8W0 407 506 E</p>		<p>Audi 8W0 407 506 C Audi (FAW) 8W0 407 506 C</p>	
<p><b>Application info</b></p> <p>Audi A4 V (8W_) (05/15--)</p>		<p>Audi A5 II (F5_) (06/16--)</p>	
Control arm		116 050 0247	MCA1197
<p><b>Notes</b></p> <p>Aluminium Control Arm Front Axle Left Rear Upper with ball joint with rubber mount</p> <p>Paired article number Required quantity replacement in pairs recommended</p>			
<p><b>References</b></p> <p>Audi 8W0 407 509 A Audi 8W0 407 509 E</p>		<p>Audi 8W0 407 509 B Audi (FAW) 8W0 407 509 B</p>	
<p><b>Application info</b></p> <p>Audi A4 V (8W_) (05/15--)</p>		<p>Audi A5 II (F5_) (06/16--)</p>	

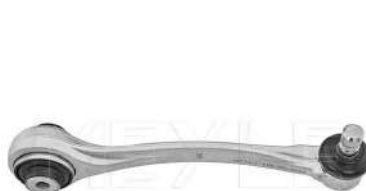

Control arm		116 050 0248	MCA1198
<p><b>Notes</b></p> <p>Aluminium Control Arm Front Axle Right Rear Upper with ball joint with rubber mount</p> <p>Paired article number Required quantity replacement in pairs recommended</p>			
<p><b>References</b></p> <p>Audi 8W0 407 510 A Audi 8W0 407 510 E</p>		<p>Audi 8W0 407 510 B Audi (FAW) 8W0 407 510 B</p>	
<p><b>Application info</b></p> <p>Audi A4 V (8W_) (05/15--)</p>		<p>Audi A5 II (F5_) (06/16--)</p>	
Control arm		116 050 0249/S	MCA1618
<p><b>Notes</b></p> <p>Aluminium Control Arm Front Axle Left Front Axle Right Upper with fastening material</p> <p>Required quantity replacement in pairs recommended</p>			
<p><b>References</b></p> <p>Porsche 958 341 051 00</p>		<p>Volkswagen 7P0 407 021</p>	
<p><b>Application info</b></p> <p>Porsche Cayenne II (92A) (06/10--)</p>		<p>Volkswagen Touareg II (7P5) (01/10-12/18)</p>	

**Control arm** **116 050 0255** **MCA1347**

**Notes**

Aluminium  
Control Arm  
Front Axle Left  
Lower  
Rear  
Paired article number 116 050 0256 | MCA1348  
Required quantity 1  
replacement in pairs recommended



**References**

Audi 4M0 407 693 C	Audi 4M0 407 693 D
Audi 4M0 407 693 E	Audi 4M0 407 693 F
Porsche 958 407 693 00	Porsche PAB 407 693
Volkswagen 4M0 407 693 C	Volkswagen 4M0 407 693 D
Volkswagen 4M0 407 693 E	Volkswagen 4M0 407 693 F

**Application info**

Audi A8 IV (4N_) (06/17--)	Audi E-TRON (GE_) (09/18--)
Audi Q7 II (4M_) (01/15--)	Audi Q8 (4MN) (02/18--)
Audi Q8 E-TRON (11/22--)	Porsche Cayenne III (9Y_) (05/17--)
Volkswagen Touareg III (CR7) (11/17--)	

**Control arm** **116 050 0256** **MCA1348**

**Notes**

Aluminium  
Control Arm  
Front Axle Right  
Lower  
Rear  
Paired article number 116 050 0255 | MCA1347  
Required quantity 1  
replacement in pairs recommended



**References**

Audi 4M0 407 694 C	Audi 4M0 407 694 D
Audi 4M0 407 694 E	Audi 4M0 407 694 F
Porsche 958 407 694 00	Porsche PAB 407 694
Volkswagen 4M0 407 694 C	Volkswagen 4M0 407 694 D
Volkswagen 4M0 407 694 E	Volkswagen 4M0 407 694 F

**Application info**

Audi A8 IV (4N\_) (06/17--)

Audi Q7 II (4M\_) (01/15--)

Audi Q8 E-TRON (11/22--)

Volkswagen Touareg III (CR7) (11/17--)

Audi E-TRON (GE\_) (09/18--)

Audi Q8 (4MN) (02/18--)

Porsche Cayenne III (9Y\_) (05/17--)

**Control arm**

116 050 0261

MCA1510

**Notes**

Control Arm  
 Front Axle Left  
 Lower  
 Sheet Steel  
 with rubber mount  
 without ball joint  
 Paired article number 116 050 0262 | MCA1511  
 Required quantity 1  
 replacement in pairs recommended



**References**

Audi 81A 407 151 D

Audi 81A 407 151 E

**Application info**

Audi Q2 (06/16--)

Volkswagen Golf VIII (CB1) (07/19--)

Volkswagen Golf VII (5G1,BA5) (08/12--)

**Control arm**

116 050 0262

MCA1511

**Notes**

Control Arm  
 Front Axle Right  
 Lower  
 Sheet Steel  
 with rubber mount  
 without ball joint  
 Paired article number 116 050 0261 | MCA1510  
 Paired article number 116 050 0267  
 Required quantity 1  
 replacement in pairs recommended



**References**

Audi 81A 407 152 D

Audi 81A 407 152 E

**Application info**

Audi Q2 (06/16--)

Volkswagen Golf VII (5G1,BA5) (08/12--)

Volkswagen Golf VIII (CB1) (07/19--)

**Control arm****116 050 0264/HD****MCA1180HD****Notes**

Aluminium  
Carbon Neutral  
Control Arm  
Front Axle Right  
Lower  
Rear  
with ball joint  
with fastening material  
with rubber mount



Paired article number

116 050 0265/HD | MCA1181HD

Replace in pairs only

Required quantity

1

Thread Size

M14x1,5

reinforced version

**References**

Audi 4G0 407 694 D

Audi 4G0 407 694 E

Audi 4G0 407 694 F

Audi 4G0 407 694 G

Audi 4G0 407 694 H

Audi 4G0 407 694 J

Audi 4G0 407 694 K

Audi 4G0 407 694 L

Audi (FAW) 4GD 407 694

Audi (FAW) 4GD 407 694 A

Audi (FAW) 4GD 407 694 B

**Application info**

Audi A6 IV (4G2, 4G5, C7) (11/10-09/18)

Audi A7 I Sportback (4G\_) (07/10-05/18)

**Control arm** **116 050 0265/HD** **MCA1181HD**

**Notes**

Aluminium  
Carbon Neutral  
Control Arm  
Front Axle Left  
Lower  
Rear  
with ball joint  
with fastening material  
with rubber mount

Paired article number 116 050 0264/HD | MCA1180HD  
Replace in pairs only  
Required quantity 1  
Thread Size M14x1,5  
reinforced version



**References**

- |                          |                        |
|--------------------------|------------------------|
| Audi 4G0 407 693 D       | Audi 4G0 407 693 E     |
| Audi 4G0 407 693 F       | Audi 4G0 407 693 G     |
| Audi 4G0 407 693 H       | Audi 4G0 407 693 J     |
| Audi 4G0 407 693 K       | Audi 4G0 407 693 L     |
| Audi (FAW) 4G0 407 693 A | Audi (FAW) 4GD 407 693 |
| Audi (FAW) 4GD 407 693 B |                        |

**Application info**

Audi A6 IV (4G2, 4G5, C7) (11/10-09/18) Audi A7 I Sportback (4G\_) (07/10-05/18)

**Control arm** **116 050 0272/HD** **MCA1515HD**

**Notes**

Aluminium  
Carbon Neutral  
Control Arm  
Front Axle Right  
Lower  
Rear

Paired article number 116 050 0273/HD | MCA1516HD  
Replace in pairs only  
Required quantity 1  
reinforced version



**References**

Audi 80A 407 694 B  
 Audi 80A 407 694 D  
 Audi 80A 407 694 G

Audi 80A 407 694 C  
 Audi 80A 407 694 E  
 Audi 80A 407 696 D

**Application info**

Audi A6 V (C8, 4A2) (02/18--)  
 Audi Q5 II (FY\_) (05/16--)

Audi A7 II Sportback (4K\_) (10/17--)

**Control arm**

116 050 0273/HD

MCA1516HD

**Notes**

Aluminium  
 Carbon Neutral  
 Control Arm  
 Front Axle Left  
 Lower  
 Rear  
 Length [mm] 448.7  
 Paired article number 116 050 0272/HD | MCA1515HD  
 Replace in pairs only  
 Required quantity 1  
 reinforced version



**References**

Audi 80A 407 693 B  
 Audi 80A 407 693 D  
 Audi 80A 407 693 G

Audi 80A 407 693 C  
 Audi 80A 407 693 E  
 Audi 80A 407 695 D

**Application info**

Audi A6 V (C8, 4A2) (02/18--)  
 Audi Q5 II (FY\_) (05/16--)

Audi A7 II Sportback (4K\_) (10/17--)

**Control arm**

116 050 0281

MCA1497

**Notes**

Control Arm  
 Front Axle Left  
 Lower  
 Sheet Steel  
 without ball joint  
 Paired article number 116 050 0282 | MCA1498  
 Required quantity 1  
 replacement in pairs recommended



**References**

Audi 2Q0 407 151 D  
 Seat 2Q0 407 151 D  
 Skoda 2Q0 407 151 D  
 Volkswagen 2Q0 407 151 D

Audi 2Q0 498 151  
 Seat 2Q0 498 151  
 Skoda 2Q0 498 151  
 Volkswagen 2Q0 498 151

**Application info**

Audi A1 II (GB\_) (07/18--)  
 Seat Ibiza V (KJ1) (01/17--)  
 Skoda Kamiq (07/19--)  
 Volkswagen Polo (AW1) (06/17--)

Seat Arona (KJ7) (07/17--)  
 Skoda Fabia IV (PJ3) (06/21--)  
 Skoda Scala (02/19--)  
 Volkswagen T-Cross (12/18--)

**Control arm****116 050 0282****MCA1498****Notes**

Control Arm  
 Front Axle Right  
 Lower  
 Sheet Steel  
 without ball joint  
 Paired article number  
 Required quantity  
 replacement in pairs recommended

116 050 0281 | MCA1497  
 1

**References**

Audi 2Q0 407 151  
 Seat 2Q0 407 151  
 Skoda 2Q0 407 151  
 Volkswagen 2Q0 407 151

Audi 2Q0 407 152 D  
 Seat 2Q0 407 152 D  
 Skoda 2Q0 407 152 D  
 Volkswagen 2Q0 407 152 D

**Application info**

Audi A1 II (GB\_) (07/18--)  
 Seat Ibiza V (KJ1) (01/17--)  
 Skoda Kamiq (07/19--)  
 Volkswagen Polo (AW1) (06/17--)

Seat Arona (KJ7) (07/17--)  
 Skoda Fabia IV (PJ3) (06/21--)  
 Skoda Scala (02/19--)  
 Volkswagen T-Cross (12/18--)

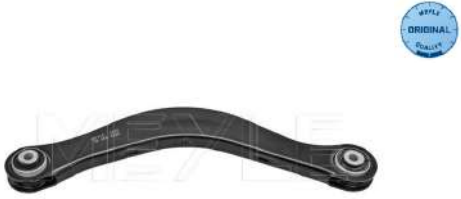
Control arm		116 050 0285	MCA1340
<p><b>Notes</b></p> <p>Control Arm Rear Rear Axle Right Sheet Steel Upper</p> <p>Paired article number Required quantity replacement in pairs recommended</p>			
<p><b>References</b></p> <p>Audi 8W0 505 398 C Audi 8W0 505 398 F</p>		<p>Audi 8W0 505 398 E</p>	
<p><b>Application info</b></p> <p>Audi A4 V (8W_) (05/15--)</p>		<p>Audi A5 II (F5_) (06/16--)</p>	
Control arm		116 050 0286	MCA1341
<p><b>Notes</b></p> <p>Control Arm Rear Rear Axle Left Sheet Steel Upper</p> <p>Paired article number Required quantity replacement in pairs recommended</p>			
<p><b>References</b></p> <p>Audi 8W0 505 397 C Audi 8W0 505 397 F</p>		<p>Audi 8W0 505 397 E</p>	
<p><b>Application info</b></p> <p>Audi A4 V (8W_) (05/15--)</p>		<p>Audi A5 II (F5_) (06/16--)</p>	





**Control arm****116 050 0289****MCA1457****Notes**

Control Arm  
 Front Axle Left  
 Sheet Steel  
 with ball joint

Paired article number  
 Required quantity  
 replacement in pairs recommended

116 050 0290 | MCA1458  
 1

**References**

Audi 2Q0 407 151 C  
 Seat 2Q0 407 151 C  
 Skoda 2Q0 407 151 C  
 Volkswagen 2Q0 407 151 C

Audi 2Q0 407 151 E  
 Seat 2Q0 407 151 E  
 Skoda 2Q0 407 151 E  
 Volkswagen 2Q0 407 151 E

**Application info**

Audi A1 II (GB\_) (07/18--)  
 Seat Ibiza V (KJ1) (01/17--)  
 Skoda Scala (02/19--)  
 Volkswagen Polo (AW1) (06/17--)

Seat Arona (KJ7) (07/17--)  
 Skoda Kamiq (07/19--)  
 Volkswagen Nivus / Taigo (11/21--)  
 Volkswagen T-Cross (12/18--)

**Control arm****116 050 0290****MCA1458****Notes**

Control Arm  
 Front Axle Right  
 Sheet Steel  
 with ball joint

Paired article number  
 Required quantity  
 replacement in pairs recommended

116 050 0289 | MCA1457  
 1

**References**

Audi 2Q0 407 152 C  
 Seat 2Q0 407 152 C  
 Skoda 2Q0 407 152 C  
 Volkswagen 2Q0 407 152 C

Audi 2Q0 407 152 E  
 Seat 2Q0 407 152 E  
 Skoda 2Q0 407 152 E  
 Volkswagen 2Q0 407 152 E

**Application info**

Audi A1 II (GB\_) (07/18--)  
 Seat Ibiza V (KJ1) (01/17--)  
 Skoda Scala (02/19--)  
 Volkswagen Polo (AW1) (06/17--)

Seat Arona (KJ7) (07/17--)  
 Skoda Kamiq (07/19--)  
 Volkswagen Nivus / Taigo (11/21--)  
 Volkswagen T-Cross (12/18--)

**Control arm**

116 050 0291

MCA1342

**Notes**

Aluminium  
 Control Arm  
 Front  
 Rear Axle Left  
 Rear Axle Right  
 Upper

Required quantity  
 replacement in pairs recommended



**References**

Audi 4M0 505 323 G

Volkswagen 4M0 505 323 G

**Application info**

Audi A6 V (C8, 4A2) (02/18--)  
 Audi E-TRON (GE\_) (09/18--)  
 Audi Q7 II (4M\_) (01/15--)  
 Volkswagen Touareg III (CR7) (11/17--)

Audi A7 II Sportback (4K\_) (10/17--)  
 Audi Q5 II (FY\_) (05/16--)  
 Audi Q8 (4MN) (02/18--)

**Control arm**

116 050 0292

MCA1364

**Notes**

Aluminium  
 Control Arm  
 Rear  
 Rear Axle Right  
 Upper

Paired article number  
 Required quantity  
 replacement in pairs recommended

116 050 0293 | MCA1365  
 1

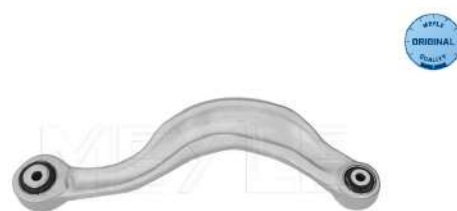

**References**

Audi 4K0 505 398 A  
 Audi 4M0 505 398 P  
 Volkswagen 4M0 505 398 P

Audi 4M0 505 398 L  
 Porsche PAB 505 398

**Application info**

Audi A6 V (C8, 4A2) (02/18--)

Audi Q5 II (FY\_) (05/16--)

Audi Q8 (4MN) (02/18--)

Volkswagen Touareg III (CR7) (11/17--)

Audi A7 II Sportback (4K\_) (10/17--)

Audi Q7 II (4M\_) (01/15--)

Porsche Cayenne III (9Y\_) (05/17--)

**Control arm**

116 050 0293

MCA1365

**Notes**

Aluminium  
Control Arm  
Rear  
Rear Axle Left  
Upper

Paired article number

116 050 0292 | MCA1364

Required quantity

1

replacement in pairs recommended



**References**

Audi 4K0 505 397 A

Audi 4M0 505 397 P

Porsche PAB 505 397

Audi 4M0 505 397 L

Audi 6K0 505 397 A

Volkswagen 4M0 505 397 P

**Application info**

Audi A6 V (C8, 4A2) (02/18--)

Audi Q5 II (FY\_) (05/16--)

Audi Q8 (4MN) (02/18--)

Volkswagen Touareg III (CR7) (11/17--)

Audi A7 II Sportback (4K\_) (10/17--)

Audi Q7 II (4M\_) (01/15--)

Porsche Cayenne III (9Y\_) (05/17--)

**Control arm**

116 050 0294

MCA1359

**Notes**

Aluminium  
Centre  
Control Arm  
Rear  
Rear Axle Left  
Rear Axle Right

Required quantity

2

replacement in pairs recommended

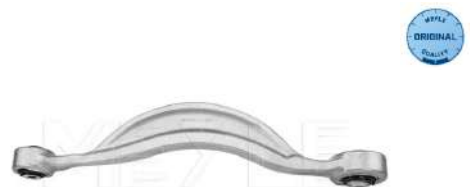

**References**

Audi 4M0 501 529 L

Volkswagen 4M0 501 529 L

**Application info**

Audi A6 V (C8, 4A2) (02/18--)

Audi E-TRON (GE\_) (09/18--)

Audi Q7 II (4M\_) (01/15--)

Volkswagen Touareg III (CR7) (11/17--)

Audi A7 II Sportback (4K\_) (10/17--)

Audi Q5 II (FY\_) (05/16--)

Audi Q8 (4MN) (02/18--)

**Control arm**

116 050 0299

MCA1488

**Notes**

Aluminium  
Control Arm  
Front  
Lower  
Rear Axle Left

Length [mm]

360

Paired article number

116 050 0300 | MCA1489

Required quantity

1

replacement in pairs recommended

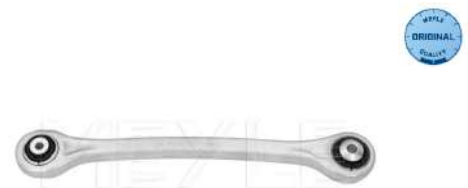

**References**

Audi 4M0 505 291 F

Audi (FAW) 4M0 505 291 F

**Application info**

Audi A6 V (C8, 4A2) (02/18--)

Audi E-TRON (GE\_) (09/18--)

Audi Q7 II (4M\_) (01/15--)

Audi A7 II Sportback (4K\_) (10/17--)

Audi Q5 II (FY\_) (05/16--)

Audi Q8 (4MN) (02/18--)

**Control arm**

116 050 0300

MCA1489

**Notes**

Aluminium  
Control Arm  
Front  
Lower  
Rear Axle Right

Length [mm]

360

Paired article number

116 050 0299 | MCA1488

Required quantity

1

replacement in pairs recommended

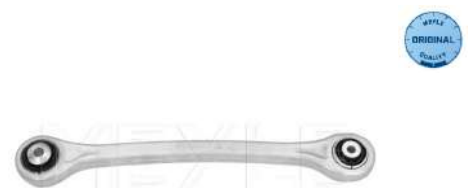

**References**

Audi 4M0 505 292 F

Audi (FAW) 4M0 505 292 F

**Application info**

Audi A6 V (C8, 4A2) (02/18--)  
 Audi E-TRON (GE\_) (09/18--)  
 Audi Q7 II (4M\_) (01/15--)

Audi A7 II Sportback (4K\_) (10/17--)  
 Audi Q5 II (FY\_) (05/16--)  
 Audi Q8 (4MN) (02/18--)

**Control arm**

116 050 0303/HD

MCA1494HD

**Notes**

Aluminium  
 Carbon Neutral  
 Control Arm  
 Front Axle Left  
 Lower  
 outer  
 without ball joint

Bore Diameter [mm] 12.3  
 Length [mm] 328  
 Paired article number 116 050 0304/HD | MCA1495HD  
 Replace in pairs only  
 Required quantity 1  
 Width [mm] 313.8



**References**

Volkswagen 2K5 407 151

**Application info**

Volkswagen Caddy III (2KA, 2KB) (03/04-05/15)

Volkswagen Caddy IV (SA\_) (05/15--)

**Control arm**

116 050 0304/HD

MCA1495HD

**Notes**

Aluminium  
 Carbon Neutral  
 Control Arm  
 Front Axle Right  
 Lower  
 outer  
 without ball joint

Length [mm] 328  
 Paired article number 116 050 0303/HD | MCA1494HD  
 Replace in pairs only  
 Required quantity 1  
 Width [mm] 313.8



**References**

Volkswagen 2K5 407 152

**Application info**

Volkswagen Caddy III (2KA, 2KB) (03/04-05/15)

Volkswagen Caddy IV (SA\_) (05/15--)

**Control arm**

116 050 0305/HD

MCA1627HD

**Notes**

Aluminium  
Carbon Neutral  
Control Arm  
Front Axle Left  
Lower  
outer  
with ball joint

Paired article number

116 050 0306/HD | MCA1628HD

Replace in pairs only

Required quantity

1

reinforced version



**References**

Volkswagen 2K5 407 151

**Application info**

Volkswagen Caddy III (2KA, 2KB) (03/04-05/15)

Volkswagen Caddy IV (SA\_) (05/15--)

**Control arm**

116 050 0306/HD

MCA1628HD

**Notes**

Aluminium  
Carbon Neutral  
Control Arm  
Front Axle Right  
Lower  
outer  
with ball joint

Paired article number

116 050 0305/HD | MCA1627HD

Replace in pairs only

Required quantity

1

reinforced version



**References**

Volkswagen 2K5 407 152

**Application info**

Volkswagen Caddy III (2KA, 2KB) (03/04-05/15)

Volkswagen Caddy IV (SA\_) (05/15--)

**Control arm****116 050 1901/S****MCA0220****Notes**

Control Arm  
 Front Axle Left  
 Front Axle Right  
 Lower  
 Sheet Steel  
 with accessories  
 with ball joint  
 with rubber mount

Cone Size [mm]

17

Required quantity

2

replacement in pairs recommended

**References**

Volkswagen 191 407 151 B

Volkswagen 191 407 153

Volkswagen (FAW) 191 407 151 B

**Application info**

Volkswagen Golf II (19E) (08/83-12/92)

Volkswagen Jetta II (19E) (08/83-12/92)

**Control arm****116 050 1911****MCA0221****Notes**

Control Arm  
 Front Axle Left  
 Front Axle Right  
 Lower  
 Sheet Steel  
 with rubber mount

Required quantity

2

replacement in pairs recommended

**References**

Seat 191 407 151

Seat 191 407 151 B

Seat 191 407 153 A

Seat 191 407 153 B

Volkswagen 191 407 151

Volkswagen 191 407 151 A

Volkswagen 191 407 151 B

Volkswagen 191 407 153

Volkswagen 191 407 153 A

Volkswagen 191 407 153 B

Volkswagen (FAW) 191 407 151 B



**Application info**

Seat Ibiza II / Cordoba I / Inca (6K\_) (02/93-11/03)  
 Volkswagen Caddy II (9K9, 9K9B, 9U7) (11/95-06/09)  
 Volkswagen Golf II (19E) (08/83-12/92)  
 Volkswagen Polo (6K\_) (01/95-11/09)

Seat Toledo I (1L\_) (01/91-10/99)  
 Volkswagen Corrado (53I) (08/87-12/95)  
 Volkswagen Jetta II (19E) (08/83-12/92)  
 Volkswagen Polo Playa (01/95-11/09)

**Control arm**

116 050 1911/S

MCA0222

**Notes**

Control Arm  
 Front Axle Left  
 Front Axle Right  
 Lower  
 Sheet Steel  
 with ball joint  
 with rubber mount

Cone Size [mm] 19  
 Required quantity 2  
 replacement in pairs recommended



**References**

Seat 191 407 151 B  
 Volkswagen 191 407 153

Volkswagen 191 407 151 B  
 Volkswagen (FAW) 191 407 151B

**Application info**

Volkswagen Corrado (53I) (08/87-12/95)  
 Volkswagen Jetta II (19E) (08/83-12/92)

Volkswagen Golf II (19E) (08/83-12/92)  
 Volkswagen Polo Playa (01/95-11/09)

**Control arm**

116 050 8200/HD

MCA0225HD

**Notes**

Carbon Neutral  
 Control Arm  
 Front Axle Left  
 Lower  
 Steel  
 with accessories  
 with rubber mount

Length [mm] 392  
 Paired article number 116 050 8201/HD | MCA0226HD  
 Replace in pairs only  
 Required quantity 1  
 reinforced version



**References**

Audi 4A0 407 151

Audi (FAW) 4A0 407 151

**Application info**

Audi 100 (4A, C4) (12/90-11/94)

Audi A6 I (4A, C4) (06/94-12/97)

**Control arm**

116 050 8201/HD

MCA0226HD

**Notes**

Carbon Neutral  
Control Arm  
Front Axle Right  
Lower  
Steel  
with accessories  
with rubber mount

Length [mm]

392

Paired article number

116 050 8200/HD | MCA0225HD

Replace in pairs only

Required quantity

1

reinforced version



**References**

Audi 4A0 407 152

Audi (FAW) 4A0 407 152

**Application info**

Audi 100 (4A, C4) (12/90-11/94)

Audi A6 I (4A, C4) (06/94-12/97)

**Control arm**

116 050 8228/HD

MCA0227HD

**Notes**

Aluminium  
Carbon Neutral  
Control Arm  
Front  
Front Axle Left  
Front Axle Right  
Lower  
with accessories  
with rubber mount

Length [mm]

365

Replace in pairs only

Required quantity

2

reinforced version



**References**

Audi 4D0 407 151 A  
 Audi 4D0 407 151 P  
 Audi 8D0 407 151 F  
 Skoda 4D0 407 151 A  
 Skoda 8D0 407 151 E  
 Volkswagen 4D0 407 151 A  
 Volkswagen 4D0 407 151 C  
 Volkswagen 4D0 407 151 G  
 Volkswagen 4D0 407 151 J  
 Volkswagen 8D0 407 151 E  
 Volkswagen (SVW) 4D0 407 151 P

Audi 4D0 407 151 H  
 Audi 8D0 407 151 E  
 Audi (FAW) 4D0 407 151 P  
 Skoda 4D0 407 151 P  
 Skoda 8D0 407 151 F  
 Volkswagen 4D0 407 151 B  
 Volkswagen 4D0 407 151 E  
 Volkswagen 4D0 407 151 H  
 Volkswagen 4D0 407 151 P  
 Volkswagen 8D0 407 151 F

**Application info**

Audi A4 I (8D\_) (11/94-12/02)  
 Audi A8 I (4D\_) (03/94-12/05)  
 Volkswagen Passat (3B\_) (08/96-12/05)

Audi A6 II (4B, C5) (01/97-12/05)  
 Skoda Superb I (3U) (12/01-03/08)

**Control arm**

116 050 8239/HD

MCA0228HD

**Notes**

Aluminium  
 Carbon Neutral  
 Control Arm  
 Front  
 Front Axle Left  
 Front Axle Right  
 Upper  
 with rubber mount

Length [mm]  
 Replace in pairs only  
 Required quantity  
 reinforced version

318  
 2



**References**

Audi 4D0 407 505 A  
 Audi 4D0 407 505 D  
 Audi 4D0 407 505 H

Audi 4D0 407 505 B  
 Audi 4D0 407 505 F  
 Audi 4D0 407 505 J

**Application info**

Audi A8 I (4D\_) (03/94-12/05)

**Control arm** 116 050 8254 MCA0229

**Notes**

Control Arm  
 Front Axle Left  
 Front Axle Right  
 Lower  
 Sheet Steel  
 with rubber mount  
 without ball joint

Required quantity  
 replacement in pairs recommended

2



**References**

Volkswagen 1H0 407 151

**Application info**

Volkswagen Golf III (1H1, 1H5, 1E7) (10/89-12/02)

Volkswagen Vento (11/91-09/98)

**Control arm** 116 050 8254/S MCA0230

**Notes**

Control Arm  
 Front Axle Left  
 Front Axle Right  
 Lower  
 Sheet Steel  
 with ball joint  
 with rubber mount

Required quantity  
 replacement in pairs recommended

2



**References**

Volkswagen 1H0 407 151

**Application info**

Volkswagen Golf III (1H1, 1H5, 1E7) (10/89-12/02)

Volkswagen Vento (11/91-09/98)

## Control arm

116 050 8292/HD

MCA0231HD

## Notes

Aluminium  
Carbon Neutral  
Control Arm  
Front Axle Left  
Rear  
Upper  
with accessories  
with rubber mount

Length [mm]

248

Paired article number

116 050 8293/HD | MCA0232HD

Replace in pairs only

Required quantity

1

reinforced version



## References

Audi 4D0 407 509 B

Audi 4D0 407 509 F

Audi 4D0 407 509 H

Audi 4D0 407 509 K

Audi 8D0 407 509 C

Audi 8D0 407 509 F

Audi 8E0 407 509 A

Audi 8E0 407 509 E

Audi 8E0 407 509 Q

Audi (FAW) 8E0 407 509 C

Seat 8E0 407 509 P

Skoda 8E0 407 509 A

Volkswagen 4D0 407 509 D

Volkswagen 4D0 407 509 G

Volkswagen 4D0 407 509 J

Volkswagen 8D0 407 509 C

Volkswagen 8D0 407 509 F

Volkswagen 8E0 407 509 A

Volkswagen (SVW) 8D0 407 509 C

Volkswagen (SVW) 8E0 407 509 A

Audi 4D0 407 509 D

Audi 4D0 407 509 G

Audi 4D0 407 509 J

Audi 8D0 407 509 A

Audi 8D0 407 509 E

Audi 8D0 407 509 G

Audi 8E0 407 509 C

Audi 8E0 407 509 P

Audi (FAW) 8E0 407 509 A

Audi (FAW) 8E0 407 509 P

Skoda 4D0 407 509 G

Volkswagen 4D0 407 509 B

Volkswagen 4D0 407 509 F

Volkswagen 4D0 407 509 H

Volkswagen 8D0 407 509 A

Volkswagen 8D0 407 509 E

Volkswagen 8D0 407 509 G

Volkswagen 8E0 407 509 C

Volkswagen (SVW) 8D0 407 509 E

Volkswagen (SVW) 8ED 407 509

**Application info**

Audi A4 Cabriolet (8H\_) (01/02-12/09)  
 Audi A4 II (8E\_) (02/00-12/05)  
 Audi A6 II (4B, C5) (01/97-12/05)  
 Audi Allroad (4BH) (05/00-08/05)  
 Skoda Superb I (3U) (12/01-03/08)

Audi A4 I (8D\_) (11/94-12/02)  
 Audi A4 III (8E\_) (11/04-06/08)  
 Audi A8 I (4D\_) (03/94-12/05)  
 Seat Exeo (3R) (12/08-05/13)  
 Volkswagen Passat (3B\_) (08/96-12/05)

**Control arm**

116 050 8293/HD

MCA0232HD

**Notes**

Aluminium  
 Carbon Neutral  
 Control Arm  
 Front Axle Right  
 Rear  
 Upper  
 with accessories  
 with rubber mount

Length [mm]

248

Paired article number

116 050 8292/HD | MCA0231HD

Replace in pairs only

Required quantity

1

reinforced version



**References**

Audi 4D0 407 510 B	Audi 4D0 407 510 D
Audi 4D0 407 510 F	Audi 4D0 407 510 G
Audi 4D0 407 510 H	Audi 4D0 407 510 J
Audi 4D0 407 510 K	Audi 8D0 407 510 A
Audi 8D0 407 510 C	Audi 8D0 407 510 E
Audi 8D0 407 510 F	Audi 8D0 407 510 G
Audi 8E0 407 510 A	Audi 8E0 407 510 C
Audi 8E0 407 510 E	Audi 8E0 407 510 P
Audi 8E0 407 510 Q	Audi (FAW) 8E0 407 510 A
Audi (FAW) 8E0 407 510 C	Audi (FAW) 8E0 407 510 P
Seat 8E0 407 510 P	Skoda 8D0 407 510 G
Skoda 8E0 407 510 A	Volkswagen 4D0 407 510 B
Volkswagen 4D0 407 510 D	Volkswagen 4D0 407 510 F
Volkswagen 4D0 407 510 G	Volkswagen 4D0 407 510 H
Volkswagen 4D0 407 510 J	Volkswagen 8D0 407 510 A
Volkswagen 8D0 407 510 C	Volkswagen 8D0 407 510 E
Volkswagen 8D0 407 510 F	Volkswagen 8D0 407 510 G
Volkswagen 8E0 407 510 A	Volkswagen 8E0 407 510 C
Volkswagen (SVW) 8D0 407 510 C	Volkswagen (SVW) 8D0 407 510 E
Volkswagen (SVW) 8E0 407 510 A	Volkswagen (SVW) 8ED 407 510

**Application info**

Audi A4 Cabriolet (8H_) (01/02-12/09)	Audi A4 I (8D_) (11/94-12/02)
Audi A4 II (8E_) (02/00-12/05)	Audi A4 III (8E_) (11/04-06/08)
Audi A6 II (4B, C5) (01/97-12/05)	Audi A8 I (4D_) (03/94-12/05)
Audi Allroad (4BH) (05/00-08/05)	Seat Exeo (3R) (12/08-05/13)
Skoda Superb I (3U) (12/01-03/08)	Volkswagen Passat (3B_) (08/96-12/05)

## Control arm

116 050 8297/HD

MCA0233HD

## Notes

Aluminium  
Carbon Neutral  
Control Arm  
Front  
Front Axle Left  
Upper  
with accessories  
with rubber mount



Article number of recommended accessories	100 654 0013
Length [mm]	273
Paired article number	116 050 8298/HD   MCA0234HD
Replace in pairs only	
Required quantity	1
reinforced version	

## References

Audi 8D0 407 505 D	Audi 8D0 407 505 E
Audi 8D0 407 505 L	Audi 8E0 407 505 A
Audi 8E0 407 505 C	Audi 8E0 407 505 E
Audi 8E0 407 505 P	Audi 8E0 407 505 Q
Audi (FAW) 8E0 407 505 A	Audi (FAW) 8E0 407 505 C
Audi (FAW) 8E0 407 505 P	Seat 8E0 407 505 P
Skoda 8E0 407 505 A	Skoda 8E0 407 505 P
Volkswagen 4Z7 407 505 A	Volkswagen 8D0 407 505 B
Volkswagen 8D0 407 505 C	Volkswagen 8D0 407 505 E
Volkswagen 8D0 407 505 F	Volkswagen 8D0 407 505 H
Volkswagen 8D0 407 505 K	Volkswagen 8D0 407 505 L
Volkswagen 8D0 407 507 E	Volkswagen 8E0 407 505 A
Volkswagen 8E0 407 505 C	Volkswagen 8E0 407 505 P
Volkswagen (SVW) 8E0 407 505 A	Volkswagen (SVW) 8ED 407 505

## Application info

Audi A4 Cabriolet (8H_) (01/02-12/09)	Audi A4 I (8D_) (11/94-12/02)
Audi A4 II (8E_) (02/00-12/05)	Audi A4 III (8E_) (11/04-06/08)
Audi A6 II (4B, C5) (01/97-12/05)	Audi Allroad (4BH) (05/00-08/05)
Seat Exeo (3R) (12/08-05/13)	Skoda Superb I (3U) (12/01-03/08)
Volkswagen Passat (3B_) (08/96-12/05)	



## Control arm

116 050 8298/HD

MCA0234HD

## Notes

Aluminium  
Carbon Neutral  
Control Arm  
Front  
Front Axle Right  
Upper  
with accessories  
with rubber mount



Article number of recommended accessories 100 654 0013  
Length [mm] 273  
Paired article number 116 050 8297/HD | MCA0233HD  
Replace in pairs only  
Required quantity 1  
reinforced version

## References

Audi 8D0 407 506 D	Audi 8D0 407 506 E
Audi 8D0 407 506 L	Audi 8E0 407 506 A
Audi 8E0 407 506 C	Audi 8E0 407 506 E
Audi 8E0 407 506 P	Audi 8E0 407 506 Q
Audi (FAW) 8E0 407 506 A	Audi (FAW) 8E0 407 506 C
Audi (FAW) 8E0 407 506 P	Seat 8E0 407 506 P
Skoda 8E0 407 506 A	Skoda 8E0 407 506 P
Volkswagen 4Z7 407 506 A	Volkswagen 8D0 407 506 B
Volkswagen 8D0 407 506 C	Volkswagen 8D0 407 506 D
Volkswagen 8D0 407 506 E	Volkswagen 8D0 407 506 F
Volkswagen 8D0 407 506 H	Volkswagen 8D0 407 506 K
Volkswagen 8D0 407 506 L	Volkswagen 8D0 407 508 E
Volkswagen 8E0 407 506 A	Volkswagen 8E0 407 506 C
Volkswagen 8E0 407 506 P	Volkswagen (SVW) 8E0 407 506 A

## Application info

Audi A4 Cabriolet (8H_) (01/02-12/09)	Audi A4 I (8D_) (11/94-12/02)
Audi A4 II (8E_) (02/00-12/05)	Audi A4 III (8E_) (11/04-06/08)
Audi A6 II (4B, C5) (01/97-12/05)	Audi Allroad (4BH) (05/00-08/05)
Seat Exeo (3R) (12/08-05/13)	Skoda Superb I (3U) (12/01-03/08)
Volkswagen Passat (3B_) (08/96-12/05)	

## Control arm

116 050 8299/HD

MCA0235HD

## Notes

Aluminium  
Carbon Neutral  
Control Arm  
Front Axle Left  
Lower  
Rear  
with accessories  
with rubber mount

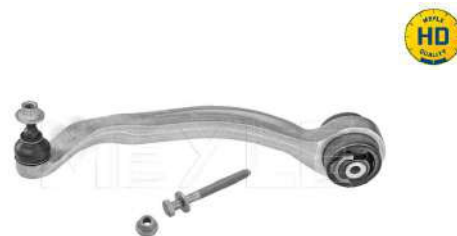

Length [mm]

383

Paired article number

116 050 8300/HD | MCA0236HD

Replace in pairs only

Required quantity

1

reinforced version

## References

Audi 4D0 407 693 AC

Audi 4D0 407 693 E

Audi 4D0 407 693 H

Audi 4D0 407 693 M

Audi 4D0 407 695 J

Audi 8E0 407 693 K

Audi (FAW) 8E0 407 693 AG

Skoda 8E0 407 693 AG

Volkswagen 4D0 407 693 N

Volkswagen 8E0 407 693 AG

Volkswagen 8E0 407 693 H

Volkswagen 8E0 407 693 Q

Audi 4D0 407 693 AD

Audi 4D0 407 693 G

Audi 4D0 407 693 K

Audi 4D0 407 693 P

Audi 8E0 407 693 AG

Audi 8E0 407 693 Q

Audi (FAW) 8E0 407 693 Q

Skoda 8E0 407 693 Q

Volkswagen 8E0 407 693

Volkswagen 8E0 407 693 E

Volkswagen 8E0 407 693 K

## Application info

Audi A4 Cabriolet (8H\_) (01/02-12/09)

Audi A4 II (8E\_) (02/00-12/05)

Audi A6 II (4B, C5) (01/97-12/05)

Skoda Superb I (3U) (12/01-03/08)

Audi A4 I (8D\_) (11/94-12/02)

Audi A4 III (8E\_) (11/04-06/08)

Audi A8 I (4D\_) (03/94-12/05)

Volkswagen Passat (3B\_) (08/96-12/05)

## Control arm

116 050 8300/HD

MCA0236HD

## Notes

Aluminium  
Carbon Neutral  
Control Arm  
Front Axle Right  
Lower  
Rear  
with accessories  
with rubber mount



Length [mm]

383

Paired article number

116 050 8299/HD | MCA0235HD

Replace in pairs only

Required quantity

1

reinforced version

## References

Audi 4D0 407 694 AC

Audi 4D0 407 694 E

Audi 4D0 407 694 H

Audi 4D0 407 694 M

Audi 4D0 407 696 J

Audi 8E0 407 694 K

Audi (FAW) 8E0 407 694 AG

Skoda 8E0 407 694 AG

Volkswagen 4D0 407 694 N

Volkswagen 8E0 407 694 AG

Volkswagen 8E0 407 694 H

Volkswagen 8E0 407 694 Q

Audi 4D0 407 694 AD

Audi 4D0 407 694 G

Audi 4D0 407 694 K

Audi 4D0 407 694 P

Audi 8E0 407 694 AG

Audi 8E0 407 694 Q

Audi (FAW) 8E0 407 694 Q

Skoda 8E0 407 694 Q

Volkswagen 8E0 407 694

Volkswagen 8E0 407 694 E

Volkswagen 8E0 407 694 K

## Application info

Audi A4 Cabriolet (8H\_) (01/02-12/09)

Audi A4 II (8E\_) (02/00-12/05)

Audi A6 II (4B, C5) (01/97-12/05)



Skoda Superb I (3U) (12/01-03/08)



Audi A4 I (8D\_) (11/94-12/02)

Audi A4 III (8E\_) (11/04-06/08)

Audi A8 I (4D\_) (03/94-12/05)

Volkswagen Passat (3B\_) (08/96-12/05)

Control arm		15-16 050 0000	MCA0244
<p><b>Notes</b></p> <p>Aluminium Control Arm Front Axle Right Upper with rubber mount</p> <p>Paired article number Required quantity replacement in pairs recommended</p>			
<p><b>References</b></p> <p>Alfa Romeo 51776226 Alfa Romeo 51834094 Alfa Romeo 60657246</p>		<p>Alfa Romeo 51776326 Alfa Romeo 60651940 Alfa Romeo 60666789</p>	
<p><b>Application info</b></p> <p>Alfa Romeo 147 (10/00-12/10) Alfa Romeo GT (937) (11/03-09/10)</p>		<p>Alfa Romeo 156 (02/97-05/06)</p>	
Control arm		15-16 050 0001	MCA0245
<p><b>Notes</b></p> <p>Aluminium Control Arm Front Axle Left Upper with rubber mount</p> <p>Paired article number Required quantity replacement in pairs recommended</p>			
<p><b>References</b></p> <p>Alfa Romeo 51776327 Alfa Romeo 60651939 Alfa Romeo 60666787</p>		<p>Alfa Romeo 51834093 Alfa Romeo 60657245</p>	
<p><b>Application info</b></p> <p>Alfa Romeo 147 (10/00-12/10) Alfa Romeo GT (937) (11/03-09/10)</p>		<p>Alfa Romeo 156 (02/97-05/06)</p>	

Control arm		15-16 050 0010	MCA0248
<p><b>Notes</b></p> <p>Aluminium Control Arm Front Axle Right Lower with ball joint with rubber mount</p> <p>Paired article number Required quantity replacement in pairs recommended</p>			
<p><b>References</b></p> <p>Alfa Romeo 50704307 Alfa Romeo 50707030 Alfa Romeo 51795446 Alfa Romeo 51842924</p>		<p>Alfa Romeo 50706859 Alfa Romeo 50707317 Alfa Romeo 51805472 Alfa Romeo 71749328</p>	
<p><b>Application info</b></p> <p>Alfa Romeo 159 (06/05-12/12) Alfa Romeo Spider (939) (03/06-03/11)</p>		<p>Alfa Romeo Brera (01/06-05/11)</p>	
Control arm		15-16 050 0011	MCA0249
<p><b>Notes</b></p> <p>Aluminium Control Arm Front Axle Left Lower with ball joint with rubber mount</p> <p>Paired article number Required quantity replacement in pairs recommended</p>			
<p><b>References</b></p> <p>Alfa Romeo 50704306 Alfa Romeo 50707029 Alfa Romeo 51795447 Alfa Romeo 51842925</p>		<p>Alfa Romeo 50706858 Alfa Romeo 50707316 Alfa Romeo 51805471 Alfa Romeo 71749327</p>	
<p><b>Application info</b></p> <p>Alfa Romeo 159 (06/05-12/12) Alfa Romeo Spider (939) (03/06-03/11)</p>		<p>Alfa Romeo Brera (01/06-05/11)</p>	

Control arm		15-16 050 0014/HD	MCA0252HD
<b>Notes</b>	<p>Aluminium Carbon Neutral Control Arm Front Axle Right Upper with ball joint with rubber mount</p> <p>Cone Pitch 1:10</p> <p>Paired article number 15-16 050 0015/HD   MCA0253HD</p> <p>Replace in pairs only</p> <p>Required quantity 1</p> <p>reinforced version</p>		

References	
Alfa Romeo 50704948	Alfa Romeo 50707480
Alfa Romeo 51787336	Alfa Romeo 51817624
Alfa Romeo 71746513	

Application info	
Alfa Romeo 159 (06/05-12/12)	Alfa Romeo Brera (01/06-05/11)
Alfa Romeo Spider (939) (03/06-03/11)	

Control arm		15-16 050 0015/HD	MCA0253HD
<b>Notes</b>	<p>Aluminium Carbon Neutral Control Arm Front Axle Left Upper with ball joint with bore for sensor with rubber mount</p> <p>Cone Pitch 1:10</p> <p>Paired article number 15-16 050 0014/HD   MCA0252HD</p> <p>Replace in pairs only</p> <p>Required quantity 1</p> <p>reinforced version</p>		

**References**

Alfa Romeo 50704947  
 Alfa Romeo 51787337  
 Alfa Romeo 71746512

Alfa Romeo 50707481  
 Alfa Romeo 51817623

**Application info**

Alfa Romeo 159 (06/05-12/12)  
 Alfa Romeo Spider (939) (03/06-03/11)

Alfa Romeo Brera (01/06-05/11)

**Control arm****15-16 050 0020/HD****MCA0876HD****Notes**

Aluminium  
 Carbon Neutral  
 Control Arm  
 Front Axle Left  
 Upper  
 with ball joint  
 with bore for sensor  
 with rubber mount

Cone Pitch

1:6

Paired article number

15-16 050 0021/HD | MCA0877HD

Replace in pairs only

Required quantity

1

reinforced version

**References**

Alfa Romeo 51828661

Alfa Romeo 51835397

**Application info**

Alfa Romeo 159 (06/05-12/12)  
 Alfa Romeo Spider (939) (03/06-03/11)

Alfa Romeo Brera (01/06-05/11)

**Control arm****15-16 050 0021/HD****MCA0877HD****Notes**

Aluminium  
Carbon Neutral  
Control Arm  
Front Axle Right  
Upper  
with ball joint  
with rubber mount

Cone Pitch

1:6

Paired article number

15-16 050 0020/HD | MCA0876HD

Replace in pairs only

Required quantity

1

reinforced version

**References**

Alfa Romeo 51828660

Alfa Romeo 51835398

**Application info**

Alfa Romeo 159 (06/05-12/12)

Alfa Romeo Brera (01/06-05/11)

Alfa Romeo Spider (939) (03/06-03/11)

**Control arm****15-16 050 0030****MCA1589****Notes**

Aluminium  
Centre  
Front  
Rear Axle Left  
Rear Axle Right  
Semi-Trailing Arm  
for left-hand drive vehicles  
for right-hand drive vehicles

Bore Diameter [mm]

12.2

Length [mm]

195

Required quantity

2

replacement in pairs recommended

**References**



Alfa Romeo 50540594

**Application info**

Alfa Romeo Giulia (952) (10/15--)

Alfa Romeo Stelvio (949) (12/16--)



Control arm		15-16 050 0031	MCA1592
<p><b>Notes</b></p> <p>Aluminium Control Arm Rear Rear Axle Left Rear Axle Right Upper for left-hand drive vehicles for right-hand drive vehicles</p> <p>Length [mm] 281 Required quantity 2 replacement in pairs recommended</p>			
<p><b>References</b></p> <p>Alfa Romeo 50541788 Alfa Romeo 50543275</p>			
<p><b>Application info</b></p> <p>Alfa Romeo Giulia (952) (10/15--) Alfa Romeo Stelvio (949) (12/16--)</p>			
Control arm		16-16 050 0005	MCA0258
<p><b>Notes</b></p> <p>Control Arm Front Axle Right Lower Sheet Steel with ball joint with rubber mount</p> <p>Paired article number 16-16 050 0006   MCA0259 Required quantity 1 replacement in pairs recommended</p>			
<p><b>References</b></p> <p>Renault 7700820029 Renault 8200737126</p>			
<p><b>Application info</b></p> <p>Renault Twingo I (03/93-10/12)</p>			

**Control arm**

16-16 050 0006

MCA0259

**Notes**

Control Arm  
Front Axle Left  
Lower  
Sheet Steel  
with ball joint  
with rubber mount

Paired article number

16-16 050 0005 | MCA0258

Required quantity

1

replacement in pairs recommended

**References**

Renault 7700820028

Renault 8200737125

**Application info**

Renault Twingo I (03/93-10/12)

**Control arm**

16-16 050 0007/HD

MCA0260HD

**Notes**

Carbon Neutral  
Control Arm  
Front Axle Right  
Lower  
Sheet Steel  
with ball joint  
with rubber mount

Paired article number

16-16 050 0008/HD | MCA0261HD

Replace in pairs only

Required quantity

1

reinforced version

**References**

Nissan 54500-00Q0D

Nissan 54500-00Q0J

Nissan 54500-00Q0M

Nissan 54500-00Q1A

Nissan 54500-00QAH

Renault 7700310810

Renault 7700313945

Renault 7700420033

Renault 7700425033

Renault 7700425228

Renault 8200197187

Renault 8200197189

Renault 8200737129

Renault 8200737141

Renault 8200942408

**Application info**

Nissan Kubistar (08/03--)  
Renault Kangoo I (08/97--)

Renault Clio II / Thalia (02/98--)

**Control arm**

16-16 050 0008/HD

MCA0261HD

**Notes**

Carbon Neutral  
Control Arm  
Front Axle Left  
Lower  
Sheet Steel  
with ball joint  
with rubber mount

Paired article number 16-16 050 0007/HD | MCA0260HD  
Replace in pairs only  
Required quantity 1  
reinforced version



**References**

- |                    |                    |
|--------------------|--------------------|
| Nissan 54501-00Q0D | Nissan 54501-00Q0G |
| Nissan 54501-00Q0K | Nissan 54501-00Q0L |
| Nissan 54501-00QAG | Nissan 54501-00QAH |
| Renault 7700310809 | Renault 7700313944 |
| Renault 7700420032 | Renault 7700425032 |
| Renault 7700425227 | Renault 8200197179 |
| Renault 8200197181 | Renault 8200737123 |
| Renault 8200737138 | Renault 8200942407 |

**Application info**

Nissan Kubistar (08/03--)  
Renault Kangoo I (08/97--)

Renault Clio II / Thalia (02/98--)

**Control arm**

16-16 050 0015

MCA0264

**Notes**

Control Arm  
Front Axle Left  
Lower  
Sheet Steel  
with ball joint  
with rubber mount

Paired article number 16-16 050 0016 | MCA0265  
Required quantity 1  
replacement in pairs recommended



**References**

Dacia 545011362R

Dacia 6001547520

Dacia 6001550446

Dacia 6001550911

Dacia 8200749461

Dacia 8200820930

Renault 545011362R

Renault 6001547520

Renault 6001550446

Renault 6001550911

Renault 8200820930

Dacia 545019294R

Dacia 6001549181

Dacia 6001550909

Dacia 8200216376

Dacia 8200792639

Dacia 8200910716

Renault 545019294R

Renault 6001549181

Renault 6001550909

Renault 8200216376

Renault 8200910716

**Application info**

Dacia Logan I (08/04--)

Renault Logan I (09/04--)

Dacia Sandero I (06/08--)

Renault Sandero/Stepway I (11/07--)

**Control arm****16-16 050 0016****MCA0265****Notes**

Control Arm  
Front Axle Right  
Lower  
Sheet Steel  
with ball joint  
with rubber mount

Paired article number

16-16 050 0015 | MCA0264

Required quantity

1

replacement in pairs recommended

**References**

Dacia 545000794R

Dacia 6001547519

Dacia 6001550447

Dacia 6001550912

Dacia 8200749459

Dacia 8200820918

Renault 545000794R

Renault 6001547519

Renault 6001550447

Renault 6001550912

Renault 8200820918

Dacia 545004269R

Dacia 6001549182

Dacia 6001550910

Dacia 8200216377

Dacia 8200792640

Dacia 8200910717

Renault 545004269R

Renault 6001549182

Renault 6001550910

Renault 8200216377

Renault 8200910717

**Application info**

Dacia Logan I (08/04--)  
Renault Logan I (09/04--)

Dacia Sandero I (06/08--)  
Renault Sandero/Stepway I (11/07--)

**Control arm****16-16 050 0017/HD****MCA0266HD****Notes**

Carbon Neutral  
Control Arm  
Front Axle Left  
Lower  
Sheet Steel  
with ball joint  
with rubber mount

Paired article number  
Replace in pairs only  
Required quantity  
reinforced version

16-16 050 0018/HD | MCA0267HD

1

**References**

GENERAL MOTORS 91166462  
GENERAL MOTORS 93858141  
Nissan 54503-00Q0A  
Nissan 54503-00QAA  
Opel 44 08 958  
Opel 44 18 223  
Renault 8200247898  
Vauxhall 44 08 958

GENERAL MOTORS 93851117  
GENERAL MOTORS 95523358  
Nissan 54503-00Q0B  
Nissan 54503-00QAB  
Opel 44 12 934  
Renault 8200054003  
Renault 8200565072  
Vauxhall 44 12 934

**Application info**

Nissan Primastar I (X83) (03/01--)  
Renault Trafic II (03/01--)

Opel Vivaro A (08/01--)  
Vauxhall Vivaro A (08/01-07/14)

**Control arm**

16-16 050 0018/HD

MCA0267HD

**Notes**

Carbon Neutral  
Control Arm  
Front Axle Right  
Lower  
Sheet Steel  
with ball joint  
with rubber mount



Paired article number 16-16 050 0017/HD | MCA0266HD  
Replace in pairs only  
Required quantity 1  
reinforced version

**References**

- |                         |                         |
|-------------------------|-------------------------|
| GENERAL MOTORS 91166461 | GENERAL MOTORS 93851118 |
| GENERAL MOTORS 93858142 | GENERAL MOTORS 95523257 |
| Nissan 54502-00Q0A      | Nissan 54502-00Q0B      |
| Nissan 54502-00QAA      | Nissan 54502-00QAB      |
| Opel 44 08 959          | Opel 44 12 936          |
| Opel 44 18 224          | Renault 545042846R      |
| Renault 8200054006      | Renault 8200247900      |
| Renault 8200565079      | Vauxhall 44 12 936      |

**Application info**

- |                                    |                                 |
|------------------------------------|---------------------------------|
| Nissan Primastar I (X83) (03/01--) | Opel Vivaro A (08/01--)         |
| Renault Trafic II (03/01--)        | Vauxhall Vivaro A (08/01-07/14) |

**Control arm**

16-16 050 0019/HD

MCA0268HD

**Notes**

Carbon Neutral  
Control Arm  
Front Axle Left  
Lower  
Sheet Steel  
with ball joint  
with rubber mount



Paired article number 16-16 050 0020/HD | MCA0269HD  
Replace in pairs only  
Required quantity 1  
reinforced version

**References**

Renault 545016805R  
 Renault 8200273728  
 Renault 8200452715

Renault 8200026654  
 Renault 8200389134  
 Renault 8200602612

**Application info**

Renault Laguna II (03/01-12/07)

**Control arm**

16-16 050 0020/HD

MCA0269HD

**Notes**

Carbon Neutral  
 Control Arm  
 Front Axle Right  
 Lower  
 Sheet Steel  
 with ball joint  
 with rubber mount

Paired article number 16-16 050 0019/HD | MCA0268HD

Replace in pairs only  
 Required quantity 1  
 reinforced version



**References**

Renault 545002029R  
 Renault 8200273729  
 Renault 8200452716

Renault 8200026655  
 Renault 8200389135  
 Renault 8200602613

**Application info**

Renault Laguna II (03/01-12/07)

**Control arm**

16-16 050 0022

MCA0271

**Notes**

Control Arm  
 Front Axle Left  
 Lower  
 Sheet Steel  
 with ball joint  
 with rubber mount

Paired article number 16-16 050 0024 | MCA0273

Required quantity 1  
 replacement in pairs recommended



**References**

Renault 8200346941  
Renault 8200744091

Renault 8200615057

**Application info**

Renault Clio III / Modus (09/04--)

**Control arm**

16-16 050 0024

MCA0273

**Notes**

Control Arm  
Front Axle Right  
Lower  
Sheet Steel  
with ball joint  
with rubber mount

Paired article number  
Required quantity  
replacement in pairs recommended

16-16 050 0022 | MCA0271  
1



**References**

Renault 8200346942  
Renault 8200744092

Renault 8200615058

**Application info**

Renault Clio III / Modus (09/04--)

**Control arm**

16-16 050 0025

MCA0274

**Notes**

Cast Steel  
Control Arm  
Front Axle Left  
Lower  
with ball joint  
with rubber mount

Paired article number  
Required quantity  
replacement in pairs recommended

16-16 050 0026 | MCA0275  
1





**References**

GENERAL MOTORS 93853464  
 GENERAL MOTORS 93862136  
 Nissan 54503-00Q0D  
 Opel 44 18 225  
 Renault 545058162R  
 Renault 8200626959  
 Vauxhall 44 17 177

GENERAL MOTORS 93858864  
 Nissan 54503-00Q0C  
 Opel 44 17 177  
 Opel 44 21 647  
 Renault 8200395007  
 Renault 8200876659

**Application info**

Nissan Primastar I (X83) (03/01--)  
 Renault Trafic II (03/01--)

Opel Vivaro A (08/01--)  
 Vauxhall Vivaro A (08/01-07/14)

**Control arm****16-16 050 0026****MCA0275****Notes**

Cast Steel  
 Control Arm  
 Front Axle Right  
 Lower  
 with ball joint  
 with rubber mount

Paired article number 16-16 050 0025 | MCA0274  
 Required quantity 1  
 replacement in pairs recommended

**References**

GENERAL MOTORS 93853465  
 GENERAL MOTORS 93862135  
 Nissan 54502-00Q0D  
 Opel 44 18 226  
 Renault 545049296R  
 Renault 8200626961  
 Vauxhall 44 17 178

GENERAL MOTORS 93858865  
 Nissan 54502-00Q0C  
 Opel 44 17 178  
 Opel 44 21 646  
 Renault 8200395034  
 Renault 8200876657

**Application info**

Nissan Primastar I (X83) (03/01--)  
 Renault Trafic II (03/01--)

Opel Vivaro A (08/01--)  
 Vauxhall Vivaro A (08/01-07/14)

Control arm		16-16 050 0027	MCA0276
<p><b>Notes</b></p> <p>Control Arm Front Axle Left Lower Steel with ball joint with rubber mount</p> <p>Paired article number Required quantity replacement in pairs recommended</p>			
<p><b>References</b></p> <p>GENERAL MOTORS 4418212 GENERAL MOTORS 9109940 GENERAL MOTORS 9160392 Nissan 54501-00Q0C Nissan 54501-00QAD Opel 44 01 852 Opel 44 04 047 Opel 45 00 092 Renault 7700302119 Renault 7701302118 Renault 8200256945 Renault 8200767822 Vauxhall 44 01 940 Vauxhall 44 18 212</p>		<p>GENERAL MOTORS 9109852 GENERAL MOTORS 9112047 GENERAL MOTORS 93192689 Nissan 54501-00QAC Nissan 54501-00QAE Opel 44 01 940 Opel 44 18 212 Renault 7700302118 Renault 7700309189 Renault 8200256944 Renault 8200270055 Vauxhall 44 01 852 Vauxhall 44 04 047 Vauxhall 45 00 092</p>	
<p><b>Application info</b></p> <p>Nissan Interstar I (X70) (04/02--) Renault Master II (03/98--)</p>		<p>Opel Movano A (07/98--) Vauxhall Movano Mk I (10/98-12/10)</p>	

Control arm		16-16 050 0028	MCA0277
<p><b>Notes</b></p> <p>Control Arm Front Axle Right Lower Steel with ball joint with rubber mount</p> <p>Paired article number Required quantity replacement in pairs recommended</p>			

**References**

- |                         |                        |
|-------------------------|------------------------|
| GENERAL MOTORS 9109853  | GENERAL MOTORS 9109941 |
| GENERAL MOTORS 9112048  | GENERAL MOTORS 9160393 |
| GENERAL MOTORS 93192690 | Nissan 54500-00Q0C     |
| Nissan 54500-00QAC      | Nissan 54500-00QAD     |
| Nissan 54500-00QAE      | Opel 44 01 853         |
| Opel 44 01 941          | Opel 44 04 048         |
| Opel 44 18 213          | Opel 45 00 093         |
| Renault 7700302119      | Renault 7700309190     |
| Renault 7701302119      | Renault 8200270058     |
| Renault 8200767825      | Vauxhall 44 01 853     |
| Vauxhall 44 01 941      | Vauxhall 44 04 048     |
| Vauxhall 44 18 213      |                        |

**Application info**

- |                                    |                                    |
|------------------------------------|------------------------------------|
| Nissan Interstar I (X70) (04/02--) | Opel Movano A (07/98--)            |
| Renault Master II (03/98--)        | Vauxhall Movano Mk I (10/98-12/10) |

**Control arm**

16-16 050 0029 MCA0278

**Notes**

Control Arm  
 Front Axle Left  
 Lower  
 Sheet Steel  
 with ball joint  
 with rubber mount  
 Paired article number 16-16 050 0030 | MCA0279  
 Required quantity 1  
 replacement in pairs recommended





**References**

- |                    |                    |
|--------------------|--------------------|
| Renault 545013698R | Renault 8200255760 |
|--------------------|--------------------|

**Application info**

- Renault Mégane II (07/01--)

Control arm		16-16 050 0030	MCA0279
<b>Notes</b>  Control Arm Front Axle Right Lower Sheet Steel with ball joint with rubber mount  Paired article number Required quantity replacement in pairs recommended			
<b>References</b> Renault 545009769R		Renault 8200255761	
<b>Application info</b> Renault Mégane II (07/01--)  <b>Control arm</b>			
<b>Notes</b>  Carbon Neutral Control Arm Front Axle Left Lower Sheet Steel with ball joint with rubber mount  Paired article number Replace in pairs only Required quantity reinforced version			
<b>References</b> Renault 545018433R Renault 545051051R Renault 8200266038 Renault 8200458813 Renault 8200602616		Renault 545050804R Renault 8200204837 Renault 8200423381 Renault 8200484810 Renault 8200602619	
<b>Application info</b> Renault Espace IV (11/02--)  Renault Vel Satis (06/02--)  <b>Control arm</b>			
<b>Notes</b>  Carbon Neutral Control Arm Front Axle Left Lower Sheet Steel with ball joint with rubber mount  Paired article number Replace in pairs only Required quantity reinforced version			
<b>References</b> Renault 545018433R Renault 545051051R Renault 8200266038 Renault 8200458813 Renault 8200602616		Renault 545050804R Renault 8200204837 Renault 8200423381 Renault 8200484810 Renault 8200602619	
<b>Application info</b> Renault Espace IV (11/02--)  Renault Vel Satis (06/02--)  <b>Control arm</b>			

**Control arm** **16-16 050 0032/HD** **MCA0281HD**

<b>Notes</b>	Carbon Neutral Control Arm Front Axle Right Lower Sheet Steel with ball joint with rubber mount	
Paired article number	16-16 050 0031/HD   MCA0280HD	
Replace in pairs only		
Required quantity	1	
reinforced version		

<b>References</b>	
Renault 545048101R	Renault 8200204838
Renault 8200266041	Renault 8200423380
Renault 8200423382	Renault 8200458814
Renault 8200484811	Renault 8200602617
Renault 8200602620	

<b>Application info</b>	Renault Espace IV (11/02--)	Renault Vel Satis (06/02--)
-------------------------	-----------------------------	-----------------------------

**Control arm** **16-16 050 0041/HD** **MCA0286HD**

<b>Notes</b>	Carbon Neutral Control Arm Front Axle Left Lower Sheet Steel with ball joint with rubber mount	
Bore Diameter [mm]	12	
Paired article number	16-16 050 0042/HD   MCA0287HD	
Replace in pairs only		
Required quantity	1	
reinforced version		

<b>References</b>	
Renault 7700425724	Renault 7700430765
Renault 7700834916	Renault 8200737132

**Application info**

Renault Mégane I / Scénic I (08/95-07/10)

**Control arm**

16-16 050 0042/HD

MCA0287HD

**Notes**

Carbon Neutral  
Control Arm  
Front Axle Right  
Lower  
Sheet Steel  
with ball joint  
with rubber mount

Bore Diameter [mm]

12

Paired article number

16-16 050 0041/HD | MCA0286HD

Replace in pairs only

Required quantity

1

reinforced version

**References**

Renault 7700425725

Renault 7700430766

Renault 7700834917

Renault 8200737133

**Application info**

Renault Mégane I / Scénic I (08/95-07/10)

**Control arm**

16-16 050 0043/HD

MCA0771HD

**Notes**

Carbon Neutral  
Control Arm  
Front Axle Left  
Lower  
Sheet Steel  
with ball joint  
with rubber mount

Paired article number

16-16 050 0044/HD | MCA0772HD

Replace in pairs only

Required quantity

1

Thread Size

M12x1,25

reinforced version

**References**

Renault 545010008R

Renault 545010009R

Renault 545010012R

**Application info**

Renault Laguna III / Coupe / Grandtour (10/07-12/15)

**Control arm**

16-16 050 0044/HD

MCA0772HD

**Notes**

Carbon Neutral  
Control Arm  
Front Axle Right  
Lower  
Sheet Steel  
with ball joint  
with rubber mount

Paired article number 16-16 050 0043/HD | MCA0771HD  
Replace in pairs only  
Required quantity 1  
Thread Size M12x1,25  
reinforced version

**References**

Renault 545000001R

Renault 545000002R

Renault 545000011R

**Application info**

Renault Laguna III / Coupe / Grandtour (10/07-12/15)

**Control arm**

16-16 050 0045

MCA0288

**Notes**

Control Arm  
Front Axle Left  
Lower  
Sheet Steel  
with ball joint  
with rubber mount

Paired article number 16-16 050 0046 | MCA0289  
Required quantity 1  
replacement in pairs recommended

**References**

Mercedes-Benz 415 330 03 00





Mercedes-Benz A 415 330 03 00

Renault 8200586561



**Application info**





Mercedes-Benz BM 415 (Citan) (11/12--)

Renault Kangoo II (02/08--)

Control arm		16-16 050 0046	MCA0289
<b>Notes</b>  Paired article number Required quantity replacement in pairs recommended	Control Arm Front Axle Right Lower Sheet Steel with ball joint with rubber mount  16-16 050 0045   MCA0288  1	 	
<b>References</b> Mercedes-Benz 415 330 02 00 Renault 8200586567		Mercedes-Benz A 415 330 02 00	
<b>Application info</b> Mercedes-Benz BM 415 (Citan) (11/12--)		Renault Kangoo II (02/08--)	
Control arm		16-16 050 0047	MCA0290
<b>Notes</b>  Paired article number Required quantity replacement in pairs recommended	Control Arm Front Axle Left Lower Sheet Steel with ball joint with rubber mount  16-16 050 0048   MCA0291  1	 	
<b>References</b> Renault 545014055R		Renault 545018194R	
<b>Application info</b> Renault Fluence (02/10--) Renault Scénic III (12/08--)		Renault Megane III (11/08--)	



Control arm		16-16 050 0048	MCA0291
<b>Notes</b>  Paired article number Required quantity replacement in pairs recommended		Control Arm Front Axle Right Lower Sheet Steel with ball joint with rubber mount 16-16 050 0047   MCA0290 1	
<b>References</b> Renault 545008682R		Renault 545009207R	
<b>Application info</b> Renault Fluence (02/10--) Renault Scénic III (12/08--)		Renault Megane III (11/08--)	
Control arm		16-16 050 0049	MCA0292
<b>Notes</b>  Paired article number Required quantity replacement in pairs recommended		Control Arm Front Axle Left Sheet Steel with ball joint with rubber mount 16-16 050 0050   MCA0293 1	
<b>References</b> Dacia 545011697R Dacia 545016746R Renault 545011697R Renault 545016746R		Dacia 545012815R Dacia 545019969R Renault 545012815R Renault 545019969R	
<b>Application info</b> Dacia Duster I (04/10--)		Renault Duster I (01/11--)	

Control arm		16-16 050 0050	MCA0293
<b>Notes</b>  Control Arm Front Axle Right Sheet Steel with ball joint with rubber mount  Paired article number Required quantity replacement in pairs recommended		 	
<b>References</b> Dacia 545000138R Dacia 545001535R Dacia 545501225R Renault 545001225R Renault 545006542R		Dacia 545001225R Dacia 545006542R Renault 545000138R Renault 545001535R Renault 545501225R	
<b>Application info</b> Dacia Duster I (04/10--)		Renault Duster I (01/11--)	
Control arm		16-16 050 0051/HD	MCA0294HD
<b>Notes</b>  Carbon Neutral Control Arm Front Axle Left Lower Sheet Steel with ball joint with rubber mount  Paired article number Replace in pairs only Required quantity reinforced version		 	
<b>References</b> Renault 8200763294 Renault 8200942392		Renault 8200763301 Renault 8200942405	
<b>Application info</b> Renault Twingo II / Wind (03/07--)			

## Control arm

16-16 050 0052/HD

MCA0295HD

## Notes

Carbon Neutral  
Control Arm  
Front Axle Right  
Lower  
Sheet Steel  
with ball joint  
with rubber mount

Paired article number 16-16 050 0051/HD | MCA0294HD  
Replace in pairs only  
Required quantity 1  
reinforced version



## References

Renault 8200663584  
Renault 8200763296  
Renault 8200942406

Renault 8200763290  
Renault 8200942396

## Application info

Renault Twingo II / Wind (03/07--)

## Control arm

16-16 050 0055

MCA0788

## Notes

Control Arm  
Front Axle Right  
Sheet Steel  
with ball joint  
with rubber mount

Paired article number 16-16 050 0056 | MCA0789  
Required quantity 1  
replacement in pairs recommended



## References



Renault 545046162R  
Renault 545048506R



Renault 545046817R  
Renault 545049968R

## Application info

Renault Clio IV (11/12--)

Renault Zoe (06/12--)

Control arm		16-16 050 0056	MCA0789
<b>Notes</b>  Paired article number Required quantity replacement in pairs recommended		Control Arm Front Axle Left Sheet Steel with ball joint with rubber mount 16-16 050 0055   MCA0788 1	
<b>References</b> Renault 545052354R		Renault 545055711R	
<b>Application info</b> Renault Clio IV (11/12--)		Renault Zoe (06/12--)	
Control arm		16-16 050 0059	MCA1155
<b>Notes</b>  Paired article number Required quantity Thread Size replacement in pairs recommended		Control Arm Front Axle Left Sheet Steel with ball joint with rubber mount 16-16 050 0060   MCA1156 1 M12x1,25	
<b>References</b> Renault 545050794R		Renault 545058191R	
<b>Application info</b> Renault Clio IV (11/12--)			

Control arm		16-16 050 0060	MCA1156
<p><b>Notes</b></p> <p>Control Arm Front Axle Right Sheet Steel with ball joint with rubber mount</p> <p>Paired article number 16-16 050 0059   MCA1155 Required quantity 1 Thread Size M12x1,25 replacement in pairs recommended</p>			
<p><b>References</b></p> <p>Renault 545041876R Renault 545044506R</p>			
<p><b>Application info</b></p> <p>Renault Clio IV (11/12--)</p>			
Control arm		16-16 050 0066	MCA1114
<p><b>Notes</b></p> <p>Control Arm Front Axle Right Lower Sheet Steel outer with ball joint with rubber mount</p> <p>Paired article number 16-16 050 0067   MCA1115 Required quantity 1 replacement in pairs recommended</p>			
<p><b>References</b></p> <p>Dacia 545001064R Dacia 545004529R Dacia 545006623R Dacia 545007106R Renault 545001064R Renault 545004529R Renault 545006623R Renault 545007106R</p>			

**Application info**

Dacia Dokker (11/12--)  
 Dacia Logan I (08/04--)  
 Dacia Sandero II (10/12--)  
 Renault Lodgy (JS\_) (07/13--)  
 Renault Logan II (09/12--)  
 Renault Sandero/Stepway I (11/07--)  
 Renault Thalia III (12/13--)

Dacia Lodgy (03/12--)  
 Dacia Logan II (10/12--)  
 Renault Dokker (12/13--)  
 Renault Logan I (09/04--)  
 Renault Megane III (11/08--)  
 Renault Sandero/Stepway II (11/13--)

**Control arm****16-16 050 0067****MCA1115****Notes**

Control Arm  
 Front Axle Left  
 Lower  
 Sheet Steel  
 outer  
 with ball joint  
 with rubber mount

Paired article number  
 Required quantity  
 replacement in pairs recommended

16-16 050 0066 | MCA1114  
 1

**References**

Dacia 545010294R  
 Dacia 545017081R  
 Renault 545010294R  
 Renault 545017081R

Dacia 545011727R  
 Dacia 545019811R  
 Renault 545011727R  
 Renault 545019811R

**Application info**

Dacia Dokker (11/12--)  
 Dacia Logan I (08/04--)  
 Dacia Sandero II (10/12--)  
 Renault Lodgy (JS\_) (07/13--)  
 Renault Logan II (09/12--)  
 Renault Sandero/Stepway I (11/07--)  
 Renault Thalia III (12/13--)

Dacia Lodgy (03/12--)  
 Dacia Logan II (10/12--)  
 Renault Dokker (12/13--)  
 Renault Logan I (09/04--)  
 Renault Megane III (11/08--)  
 Renault Sandero/Stepway II (11/13--)

**Control arm****16-16 050 0068****MCA1259****Notes**

Control Arm  
Front Axle Right  
Sheet Steel

Paired article number 16-16 050 0069 | MCA1260  
Required quantity 1  
replacement in pairs recommended

**References**

Renault 545003037R	Renault 545040131R
Renault 545041327R	Renault 545045476R
Renault 545045743R	Renault 545047954R
Renault 8200298455	Renault 8200364391
Renault 8200457209	Renault 8200679067

**Application info**

Renault Captur I (06/13--)	Renault Mégane II (07/01--)
Renault Scénic II (06/03-07/10)	

**Control arm****16-16 050 0069****MCA1260****Notes**

Control Arm  
Front Axle Left  
Sheet Steel

Paired article number 16-16 050 0068 | MCA1259  
Required quantity 1  
replacement in pairs recommended

**References**

Renault 545017775R	Renault 545052737R
Renault 545053170R	Renault 545055208R
Renault 545055708R	Renault 545059335R
Renault 8200298454	Renault 8200364388
Renault 8200457208	Renault 8200679063

**Application info**

Renault Captur I (06/13--)  
Renault Scénic II (06/03-07/10)

Renault Mégane II (07/01--)

**Control arm**

16-16 050 0070/HD

MCA1593HD

**Notes**

Carbon Neutral  
Control Arm  
Front Axle Right  
Lower  
Steel  
for left-hand drive vehicles  
for right-hand drive vehicles  
with ball joint



Length [mm] 356.6  
Paired article number 16-16 050 0071/HD | MCA1594HD  
Replace in pairs only  
Required quantity 1  
Width [mm] 252.4

**References**

Renault 545000399R  
Renault 545009795R

Renault 545006560R

**Application info**

Renault Megane III (11/08--)

Renault Scénic III (12/08--)

**Control arm**

16-16 050 0071/HD

MCA1594HD

**Notes**

Carbon Neutral  
Control Arm  
Front Axle Left  
Lower  
Steel  
for left-hand drive vehicles  
for right-hand drive vehicles  
with ball joint



Length [mm] 356.6  
Paired article number 16-16 050 0070/HD | MCA1593HD  
Replace in pairs only  
Required quantity 1  
Width [mm] 252.4



**References**

Renault 545016101R  
Renault 545019389R

Renault 545016838R

**Application info**

Renault Megane III (11/08--)

Renault Scénic III (12/08--)

**Control arm****16-16 050 0073****MCA1475****Notes**

Control Arm  
Front Axle Left  
Lower  
Sheet Steel  
outer

Paired article number  
Required quantity  
replacement in pairs recommended

16-16 050 0074 | MCA1476  
1

**References**

Renault 545050873R  
Renault 545057345R  
Smart 453 330 31 00  
Smart 453 330 81 00  
Smart A 453 330 31 00  
Smart A 453 330 81 00

Renault 545051097R  
Smart 453 330 29 00  
Smart 453 330 79 00  
Smart A 453 330 29 00  
Smart A 453 330 79 00

**Application info**

Renault Twingo III (09/14--)  
Smart Fortwo III (07/14--)

Smart Forfour II (07/14--)

**Control arm****16-16 050 0074****MCA1476****Notes**

Control Arm  
Front Axle Right  
Lower  
Sheet Steel  
outer

Paired article number  
Required quantity  
replacement in pairs recommended

16-16 050 0073 | MCA1475  
1



**References**

Renault 545047654R	Renault 545048628R
Renault 545049600R	Smart 453 330 30 00
Smart 453 330 32 00	Smart 453 330 80 00
Smart 453 330 82 00	Smart A 453 330 30 00
Smart A 453 330 32 00	Smart A 453 330 80 00
Smart A 453 330 82 00	

**Application info**

Renault Twingo III (09/14--)	Smart Forfour II (07/14--)
Smart Fortwo III (07/14--)	

**Control arm**

16-16 050 0075 MCA1278

**Notes**

Control Arm  
Front Axle Left  
Lower  
Sheet Steel

Paired article number  
Required quantity  
replacement in pairs recommended

1



**References**

Renault 545057449R	Renault 545058397R
Renault 545058992R	

**Application info**

Renault Megane IV (11/15--)

**Control arm**

16-16 050 0076 MCA1279

**Notes**

Control Arm  
Front Axle Right  
Lower  
Sheet Steel

Paired article number  
Required quantity  
replacement in pairs recommended

1



**References**

Renault 545042021R  
Renault 545049566R

Renault 545045297R

**Application info**

Renault Megane IV (11/15--)

**Control arm**

16-16 050 0077

MCA1377

**Notes**

Control Arm  
Front Axle Left  
Lower  
Steel  
outer  
Paired article number 16-16 050 0078 | MCA1378  
Required quantity 1  
replacement in pairs recommended



**References**

Dacia 545055413R

Renault 545055413R

**Application info**

Dacia Duster I (04/10--)  
Renault Arkana (08/19--)  
Renault Kaptur (03/16--)

Dacia Duster II (10/17--)  
Renault Duster II (10/17--)

**Control arm**

16-16 050 0078

MCA1378

**Notes**

Control Arm  
Front Axle Right  
Lower  
Steel  
outer  
Paired article number 16-16 050 0077 | MCA1377  
Required quantity 1  
replacement in pairs recommended



**References**

Dacia 545040280R

Renault 545040280R

**Application info**

Dacia Duster I (04/10--)  
 Renault Arkana (08/19--)  
 Renault Kaptur (03/16--)

Dacia Duster II (10/17--)  
 Renault Duster II (10/17--)

**Control arm****16-16 050 7032/HD****MCA0300HD****Notes**

Carbon Neutral  
 Control Arm  
 Front Axle Right  
 Lower  
 Sheet Steel  
 with ball joint  
 with rubber mount

Bore Diameter [mm]  
 Paired article number  
 Replace in pairs only  
 Required quantity  
 reinforced version

10  
 16-16 050 7033/HD | MCA0301HD  
 1

**References**

Renault 7700436303  
 Renault 7700818052  
 Renault 8200737135

Renault 7700781035  
 Renault 7700831369

**Application info**

Renault Mégane I / Scénic I (08/95-07/10)

Renault R 19 (01/88-08/03)

**Control arm****16-16 050 7033/HD****MCA0301HD****Notes**

Carbon Neutral  
 Control Arm  
 Front Axle Left  
 Lower  
 Sheet Steel  
 with ball joint  
 with rubber mount

Bore Diameter [mm]  
 Paired article number  
 Replace in pairs only  
 Required quantity  
 reinforced version

10  
 16-16 050 7032/HD | MCA0300HD  
 1



**References**

Renault 7700436302  
 Renault 7700818051  
 Renault 8200737134

Renault 7700781034  
 Renault 7700831368

**Application info**

Renault Mégane I / Scénic I (08/95-07/10)

Renault R 19 (01/88-08/03)

**Control arm****18-16 050 0002****MCA0773****Notes**

Aluminium  
 Control Arm  
 Front Axle Left  
 Upper  
 with ball joint  
 with rubber mount

Bore Diameter [mm]

10

Paired article number

18-16 050 0003 | MCA0774

Required quantity

1

Thread Size

M12x1,75

replacement in pairs recommended

**References**

Jaguar 2R833091AD  
 Jaguar 2R833091AG  
 Jaguar 8X233091AB  
 Jaguar C2Z2279  
 Jaguar XR842383  
 Jaguar XR857653

Jaguar 2R833091AE  
 Jaguar 8X233091AA  
 Jaguar 8X233091AD  
 Jaguar XR822285  
 Jaguar XR857079  
 Jaguar XR858823

**Application info**

Jaguar S-Type (CCX) (10/98-12/08)

Jaguar XF I (X250) (03/08--)

**Control arm** **18-16 050 0003** **MCA0774**

**Notes**

Aluminium  
Control Arm  
Front Axle Right  
Upper  
with ball joint  
with rubber mount

Bore Diameter [mm] 10  
Paired article number 18-16 050 0002 | MCA0773  
Required quantity 1  
Thread Size M12x1,75  
replacement in pairs recommended



**References**

Jaguar 2R833084AD	Jaguar 2R833084AE
Jaguar 2R833084AG	Jaguar 8X233084AA
Jaguar 8X233084AD	Jaguar C2Z2278
Jaguar C2Z31677	Jaguar XR822284
Jaguar XR842382	Jaguar XR857078
Jaguar XR857652	

**Application info**

Jaguar S-Type (CCX) (10/98-12/08) Jaguar XF I (X250) (03/08--)

**Control arm** **18-16 050 0011** **MCA1343**

**Notes**

Control Arm  
Grey Cast Iron  
Rear Axle Left  
Rear Axle Right  
Upper

Required quantity 2  
replacement in pairs recommended



**References**

Ford 1 041 683	Ford 1 093 772
Ford 1 116 608	Ford 1 325 326
Ford 1S71-5500-AA	Ford 1S71-5500-AC
Ford 6 710 264	Ford 6 829 058
Ford 93BB-5500-AB	Ford 93BB-5500-AC
Ford 93BB-5500-AD	Ford 93BB-5500-AE
Jaguar C2S35280	Jaguar C2S39484
Jaguar C2S9241	

**Application info**

Ford Mondeo I, II (01/93-09/00)	Ford Mondeo III (10/00-09/07)
Jaguar X-Type (03/01-12/09)	

**Control arm**

18-16 050 0027

MCA1452

**Notes**

Aluminium  
Control Arm  
Lower  
Rear Axle Left  
Rear Axle Right  
outer  
2

Required quantity  
replacement in pairs recommended

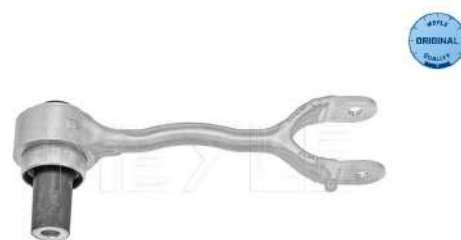

**References**



Jaguar T2H16771	Jaguar T2H2185
-----------------	----------------

**Application info**

Jaguar XE (X760) (03/15--)	Jaguar XF II (X260) (05/15--)
----------------------------	-------------------------------



Control arm		18-16 050 0028/HD	MCA1526HD
<b>Notes</b>  Aluminium Carbon Neutral Control Arm Front Axle Right Upper Length [mm] 192.5 Paired article number 18-16 050 0029/HD   MCA1527HD Replace in pairs only Required quantity 1 reinforced version			
<b>References</b> Jaguar GX733084BA Jaguar T4N1128			
<b>Application info</b> Jaguar XE (X760) (03/15--) Jaguar XF II (X260) (05/15--)			
Control arm		18-16 050 0029/HD	MCA1527HD
<b>Notes</b>  Aluminium Carbon Neutral Control Arm Front Axle Left Upper Length [mm] 192.5 Paired article number 18-16 050 0028/HD   MCA1526HD Replace in pairs only Required quantity 1 reinforced version			
<b>References</b> Jaguar GX733091BA Jaguar T4N1130			
<b>Application info</b> Jaguar XE (X760) (03/15--) Jaguar XF II (X260) (05/15--)			



Control arm		18-16 050 0030	MCA1465
<p><b>Notes</b></p> <p>Aluminium Control Arm Rear Axle Right Upper</p> <p>Paired article number Required quantity replacement in pairs recommended</p>			
<p>18-16 050 0031   MCA1466</p> <p>1</p>			
<p><b>References</b></p> <p>Jaguar T2H17173 Jaguar T4N3670</p>			
<p><b>Application info</b></p> <p>Jaguar XE (X760) (03/15--)</p> <p>Jaguar XF II (X260) (05/15--)</p>			
Control arm		18-16 050 0031	MCA1466
<p><b>Notes</b></p> <p>Aluminium Control Arm Rear Axle Left Upper</p> <p>Paired article number Required quantity replacement in pairs recommended</p>			
<p>18-16 050 0030   MCA1465</p> <p>1</p>			
<p><b>References</b></p> <p>Jaguar T2H17175 Jaguar T4N3671</p>			
<p><b>Application info</b></p> <p>Jaguar XE (X760) (03/15--)</p> <p>Jaguar XF II (X260) (05/15--)</p>			



DRIVER'S BEST FRIEND

MEYLE

Control arm		216 050 0005	MCA0308
<b>Notes</b>	Control Arm Front Axle Right Lower Steel with ball joint with rubber mount		
Paired article number	216 050 0010   MCA0313		
Required quantity	1		
replacement in pairs recommended			

<b>References</b>			
Fiat 46545661		Fiat 46551790	
Fiat 51842193			

<b>Application info</b>	Fiat Punto II (09/99-07/12)		
-------------------------	-----------------------------	--	--

Control arm		216 050 0006	MCA0309
<b>Notes</b>	Control Arm Front Axle Left Lower Steel with rubber mount		
Paired article number	216 050 0007   MCA0310		
Required quantity	1		
replacement in pairs recommended			

<b>References</b>			
Alfa Romeo 46423824		Alfa Romeo 46474556	
Alfa Romeo 60586771		Alfa Romeo 60809813	
Alfa Romeo 60813013		Alfa Romeo 60813043	
Alfa Romeo 93501116		Fiat 46456049	
Fiat 46462626		Fiat 46474556	
Fiat 60811769		Fiat 7780443	
Fiat 93501116		Lancia 46474556	

**Application info**

Alfa Romeo 145 / 146 (07/94-10/01)  
 Alfa Romeo GTV (09/94-10/05)  
 Fiat Brava / Bravo (182) (10/95-06/03)  
 Fiat Marea / Multipla (05/96-06/10)

Alfa Romeo 155 (01/92-12/97)  
 Alfa Romeo Spider (916) (09/94-04/05)  
 Fiat Coupé (11/93-08/00)

**Control arm**

216 050 0007

MCA0310

**Notes**

Control Arm  
 Front Axle Right  
 Lower  
 Steel  
 with rubber mount  
 Paired article number 216 050 0006 | MCA0309  
 Required quantity 1  
 replacement in pairs recommended



**References**



Alfa Romeo 46423825  
 Alfa Romeo 60586772  
 Alfa Romeo 60813014  
 Alfa Romeo 93501117  
 Fiat 46462627  
 Fiat 60811770  
 Fiat 93501117



Alfa Romeo 46474557  
 Alfa Romeo 60809814  
 Alfa Romeo 60813044  
 Fiat 46456050  
 Fiat 46474557  
 Fiat 7780444  
 Lancia 46474557



**Application info**



Alfa Romeo 145 / 146 (07/94-10/01)  
 Alfa Romeo GTV (09/94-10/05)  
 Fiat Brava / Bravo (182) (10/95-06/03)  
 Fiat Marea / Multipla (05/96-06/10)



Alfa Romeo 155 (01/92-12/97)  
 Alfa Romeo Spider (916) (09/94-04/05)  
 Fiat Coupé (11/93-08/00)

Control arm		216 050 0010	MCA0313
<p><b>Notes</b></p> <p>Control Arm Front Axle Left Lower Steel with ball joint with rubber mount</p> <p>Paired article number Required quantity replacement in pairs recommended</p>		 <p>MEYLE ORIGINAL</p>	
<p><b>References</b></p> <p>Fiat 46545660 Fiat 51842192</p>		<p>Fiat 46551732</p>	
<p><b>Application info</b></p> <p>Fiat Punto II (09/99-07/12)</p>			
Control arm		216 050 0015	MCA0316
<p><b>Notes</b></p> <p>Control Arm Front Axle Right Lower Steel with rubber mount</p> <p>Paired article number Required quantity replacement in pairs recommended</p>		 <p>MEYLE ORIGINAL</p>	
<p><b>References</b></p> <p>Fiat 7636996</p>			
<p><b>Application info</b></p> <p>Fiat Cinquecento / Seicento (07/91-01/10)</p>			

Control arm		216 050 0016	MCA0317
<p><b>Notes</b></p> <p>Control Arm Front Axle Left Lower Steel with rubber mount</p> <p>Paired article number 216 050 0015   MCA0316 Required quantity 1 replacement in pairs recommended</p>			
<p><b>References</b> Fiat 7636995</p>			
<p><b>Application info</b> Fiat Cinquecento / Seicento (07/91-01/10)</p>			
Control arm		216 050 0017	MCA0318
<p><b>Notes</b></p> <p>Control Arm Front Axle Right Lower Steel with rubber mount</p> <p>Paired article number 216 050 0018   MCA0319 Required quantity 1 replacement in pairs recommended</p>			
<p><b>References</b> Fiat 50700779</p>			
<p><b>Application info</b> Fiat Stilo (10/01-11/10)</p>			

Control arm		216 050 0018	MCA0319
<p><b>Notes</b></p> <p>Control Arm Front Axle Left Lower Steel with rubber mount</p> <p>Paired article number Required quantity replacement in pairs recommended</p>	<p>216 050 0017   MCA0318</p> <p>1</p>		
<p><b>References</b></p> <p>Fiat 50700797</p>			
<p><b>Application info</b></p> <p>Fiat Stilo (10/01-11/10)</p>			
Control arm		216 050 0019	MCA0320
<p><b>Notes</b></p> <p>Control Arm Front Axle Right Lower Steel with rubber mount</p> <p>Paired article number Required quantity replacement in pairs recommended</p>	<p>216 050 0020   MCA0321</p> <p>1</p>		
<p><b>References</b></p> <p>Fiat 46522142 Fiat 51832938 Lancia 46764747</p> <p>Fiat 46764747 Lancia 46522142 Lancia 51832938</p>			
<p><b>Application info</b></p> <p>Fiat Marea / Multipla (05/96-06/10) Lancia Lybra (07/99-10/05)</p>			

Control arm		216 050 0020	MCA0321
<b>Notes</b>  Control Arm Front Axle Left Lower Steel with rubber mount  Paired article number Required quantity replacement in pairs recommended			
<b>References</b> Fiat 46525407 Fiat 51832937 Lancia 46764746		Fiat 46764746 Lancia 46525407 Lancia 51832937	
<b>Application info</b> Fiat Marea / Multipla (05/96-06/10)		Lancia Lybra (07/99-10/05)	
Control arm		216 050 0021	MCA0322
<b>Notes</b>  Control Arm Front Axle Left Lower Sheet Steel with ball joint with rubber mount  Paired article number Required quantity replacement in pairs recommended			
<b>References</b> Fiat 46539001 Fiat 46794066 Fiat 51712408 Fiat 51764471 Fiat 51866701		Fiat 46777742 Fiat 46813842 Fiat 51747324 Fiat 51769074	
<b>Application info</b> Fiat Doblo (119, 223) (11/00--))		Fiat Palio / Albea / Siena / Strada (04/96--))	

Control arm		216 050 0022	MCA0323										
<p><b>Notes</b></p> <p>Control Arm Front Axle Right Lower Sheet Steel with ball joint with rubber mount</p> <p>Paired article number Required quantity replacement in pairs recommended</p>	<p>216 050 0021   MCA0322</p> <p>1</p>												
<p><b>References</b></p> <table border="0"> <tr> <td>Fiat 46539000</td> <td>Fiat 46777741</td> </tr> <tr> <td>Fiat 46794065</td> <td>Fiat 46813841</td> </tr> <tr> <td>Fiat 51712407</td> <td>Fiat 51747323</td> </tr> <tr> <td>Fiat 51764470</td> <td>Fiat 51769073</td> </tr> <tr> <td>Fiat 51866700</td> <td></td> </tr> </table>				Fiat 46539000	Fiat 46777741	Fiat 46794065	Fiat 46813841	Fiat 51712407	Fiat 51747323	Fiat 51764470	Fiat 51769073	Fiat 51866700	
Fiat 46539000	Fiat 46777741												
Fiat 46794065	Fiat 46813841												
Fiat 51712407	Fiat 51747323												
Fiat 51764470	Fiat 51769073												
Fiat 51866700													
<p><b>Application info</b></p> <table border="0"> <tr> <td>Fiat Doblo (119, 223) (11/00--)</td> <td>Fiat Palio / Albea / Siena / Strada (04/96--)</td> </tr> </table>				Fiat Doblo (119, 223) (11/00--)	Fiat Palio / Albea / Siena / Strada (04/96--)								
Fiat Doblo (119, 223) (11/00--)	Fiat Palio / Albea / Siena / Strada (04/96--)												
Control arm		216 050 0026	MCA0324										
<p><b>Notes</b></p> <p>Control Arm Front Axle Left Lower Steel with rubber mount</p> <p>Paired article number Required quantity replacement in pairs recommended</p>	<p>216 050 0027   MCA0325</p> <p>1</p>												
<p><b>References</b></p> <table border="0"> <tr> <td>Fiat 50703128</td> <td>Fiat 51857133</td> </tr> </table>				Fiat 50703128	Fiat 51857133								
Fiat 50703128	Fiat 51857133												
<p><b>Application info</b></p> <p>Fiat Panda II (09/03--)</p>													



## Control arm

216 050 0027

MCA0325

## Notes

	Control Arm Front Axle Right Lower Steel with rubber mount
Paired article number	216 050 0026   MCA0324
Required quantity	1
replacement in pairs recommended	



## References

Fiat 50703129

Fiat 51857134

## Application info

Fiat Panda II (09/03--)

## Control arm

216 050 0036/HD

MCA0329HD

## Notes

	Carbon Neutral Control Arm Front Axle Right Sheet Steel Upper with ball joint with rubber mount
Paired article number	216 050 0037/HD   MCA0330HD
Replace in pairs only	
Required quantity	1
reinforced version	



## References

Iveco 4255 1297

Iveco 5 0033 4710

Iveco 5 0034 4888



Iveco 5 0037 9802

## Application info

Iveco Daily III (11/97-10/09)



Iveco Daily IV (05/06-03/12)

Iveco Daily V (09/11-02/14)

Control arm		216 050 0037/HD	MCA0330HD
<b>Notes</b>			
	Carbon Neutral Control Arm Front Axle Left Sheet Steel Upper with ball joint with rubber mount		
Paired article number	216 050 0036/HD   MCA0329HD		
Replace in pairs only			
Required quantity reinforced version	1		

<b>References</b>			
Iveco 4255 1296		Iveco 5 0033 4711	
Iveco 5 0034 4887		Iveco 5 0037 9801	

<b>Application info</b>			
Iveco Daily III (11/97-10/09)		Iveco Daily IV (05/06-03/12)	
Iveco Daily V (09/11-02/14)			

Control arm		216 050 0038/HD	MCA0331HD
<b>Notes</b>			
	Carbon Neutral Control Arm Front Axle Right Lower Sheet Steel with ball joint with rubber mount		
Paired article number	216 050 0039/HD   MCA0332HD		
Replace in pairs only			
Required quantity reinforced version	1		

<b>References</b>			
Iveco 5 0033 4716			

<b>Application info</b>			
Iveco Daily III (11/97-10/09)		Iveco Daily IV (05/06-03/12)	
Iveco Daily V (09/11-02/14)			

**Control arm**

216 050 0039/HD

MCA0332HD

**Notes**

Carbon Neutral  
Control Arm  
Front Axle Left  
Lower  
Sheet Steel  
with ball joint  
with rubber mount

Paired article number 216 050 0038/HD | MCA0331HD  
Replace in pairs only  
Required quantity 1  
reinforced version



**References**

Iveco 5 0033 4717

**Application info**

Iveco Daily III (11/97-10/09)  
Iveco Daily V (09/11-02/14)

Iveco Daily IV (05/06-03/12)

**Control arm**

216 050 0044/HD

MCA0333HD

**Notes**

Carbon Neutral  
Control Arm  
Front Axle Left  
Lower  
Steel  
with ball joint  
with bore for sensor  
with rubber mount

Paired article number 216 050 0045/HD | MCA0334HD  
Replace in pairs only  
Required quantity 1  
reinforced version



**References**

ABARTH 50710621  
 ABARTH 51860383  
 Fiat 50709579  
 Fiat 51857021  
 Fiat 52045069  
 Ford 1 580 514  
 Ford 2 014 011  
 Ford 9S51-3078-AB  
 Ford FS51-3078-AA

ABARTH 51857021  
 ABARTH 52045069  
 Fiat 50710621  
 Fiat 51860383  
 Ford 1 540 244  
 Ford 1 639 574  
 Ford 9S51-3078-AA  
 Ford 9S51-3078-AC

**Application info**

ABARTH 500 (01/08--)  
 Ford KA II (10/08-05/16)

Fiat 500 (07/07--)

**Control arm****216 050 0045/HD****MCA0334HD****Notes**

Carbon Neutral  
 Control Arm  
 Front Axle Right  
 Lower  
 Steel  
 with ball joint  
 with rubber mount

Paired article number  
 216 050 0044/HD | MCA0333HD

Required quantity  
 1

Replace in pairs only  
 Reinforced version

**References**

ABARTH 50710620  
 ABARTH 52045068  
 Fiat 50710620  
 Fiat 52045068  
 Ford 1 548 515  
 Ford 2 014 015  
 Ford 9S51-3078-BC

ABARTH 51857022  
 Fiat 50709580  
 Fiat 51857022  
 Ford 1 540 246  
 Ford 1 639 575  
 Ford 6M2J-U23942-CA  
 Ford FS51-3078-BA

**Application info**

ABARTH 500 (01/08--)  
 Ford KA II (10/08-05/16)

Fiat 500 (07/07--)

## Control arm

216 050 0046

MCA0335

## Notes

Control Arm  
 Front Axle Left  
 Sheet Steel  
 with ball joint  
 with rubber mount

Paired article number  
 Required quantity  
 replacement in pairs recommended

216 050 0047 | MCA0336  
 1



## References

Fiat 51810665  
 Fiat 51932035  
 Fiat 52026316  
 Opel 3 52 538

Fiat 51885737  
 Fiat 52008282  
 GENERAL MOTORS 95514537  
 Vauxhall 95514537

## Application info

Fiat 500L (09/12--)  
 Opel Combo D (02/12--)

Fiat Doblo (263) (11/09--)  
 Vauxhall Combo Mk III (07/06--)

## Control arm

216 050 0047

MCA0336

## Notes

Control Arm  
 Front Axle Right  
 Sheet Steel  
 with ball joint  
 with rubber mount

Paired article number  
 Required quantity  
 replacement in pairs recommended

216 050 0046 | MCA0335  
 1



## References





Fiat 51810664  
 Fiat 51932036  
 Fiat 52026317  
 Opel 3 52 537



Fiat 51885660  
 Fiat 52008283  
 GENERAL MOTORS 95514536  
 Vauxhall 95514536



## Application info

Fiat 500L (09/12--)  
 Opel Combo D (02/12--)



Fiat Doblo (263) (11/09--)  
 Vauxhall Combo Mk III (07/06--)





Control arm		216 050 0060/HD	MCA1132HD
<p><b>Notes</b></p> <p>Carbon Neutral Control Arm Front Axle Right Sheet Steel with ball joint with rubber mount</p> <p>Paired article number Replace in pairs only Required quantity reinforced version</p>		 	
<p>216 050 0061/HD   MCA1133HD</p> <p>1</p>			
<p><b>References</b></p> <p>Peugeot 96 707 714 80</p>			
<p><b>Application info</b></p> <p>Peugeot 208 I (03/12--)</p>			
Control arm		216 050 0061/HD	MCA1133HD
<p><b>Notes</b></p> <p>Carbon Neutral Control Arm Front Axle Left Sheet Steel with ball joint with rubber mount</p> <p>Paired article number Replace in pairs only Required quantity reinforced version</p>		 	
<p>216 050 0060/HD   MCA1132HD</p> <p>1</p>			
<p><b>References</b></p> <p>Peugeot 96 707 720 80</p>			
<p><b>Application info</b></p> <p>Peugeot 208 I (03/12--)</p>			



Control arm		216 050 0062	MCA1029
<p><b>Notes</b></p> <p>Control Arm Front Axle Right Sheet Steel with ball joint with rubber mount</p> <p>Paired article number Required quantity replacement in pairs recommended</p>			
<p><b>References</b></p> <p>Fiat 51772988</p>		<p>Fiat 51772989</p>	
<p><b>Application info</b></p> <p>Fiat Doblo (119, 223) (11/00--)</p>			
Control arm		216 050 0063	MCA1030
<p><b>Notes</b></p> <p>Control Arm Front Axle Left Sheet Steel with ball joint with rubber mount</p> <p>Paired article number Required quantity replacement in pairs recommended</p>			
<p><b>References</b></p> <p>Fiat 51772992</p>		<p>Fiat 51772993</p>	
<p><b>Application info</b></p> <p>Fiat Doblo (119, 223) (11/00--)</p>			



Control arm		216 050 0064	MCA1224
<p><b>Notes</b></p> <p>Control Arm Front Axle Right Lower Sheet Steel with ball joint with rubber mount</p> <p>Paired article number Required quantity replacement in pairs recommended</p>			
<p><b>References</b></p> <p>Fiat 51849600 Fiat 51957400</p>		<p>Fiat 51928527 Fiat 52013959</p>	
<p><b>Application info</b> Fiat Panda III (02/12--)</p>			
Control arm		216 050 0065	MCA1225
<p><b>Notes</b></p> <p>Control Arm Front Axle Left Lower Sheet Steel with ball joint with rubber mount</p> <p>Paired article number Required quantity replacement in pairs recommended</p>			
<p><b>References</b></p> <p>Fiat 51849602 Fiat 51957401</p>		<p>Fiat 51928536 Fiat 52013960</p>	
<p><b>Application info</b> Fiat Panda III (02/12--)</p>			







Control arm		216 050 0068	MCA1226
<b>Notes</b>  Control Arm Front Axle Right Sheet Steel with ball joint  Paired article number Required quantity replacement in pairs recommended			
<b>References</b> Fiat 52011612 Fiat 52082897 Fiat K68385373AA		Fiat 52056673 Fiat K68326642AA	
<b>Application info</b> Fiat Tipo (356) (10/15--)			
Control arm		216 050 0069	MCA1227
<b>Notes</b>  Control Arm Front Axle Left Sheet Steel with ball joint  Paired article number Required quantity replacement in pairs recommended			
<b>References</b> Fiat 52011614 Fiat 52082896		Fiat 52056674	
<b>Application info</b> Fiat Tipo (356) (10/15--)			



Control arm		216 050 0070	MCA1351
<p><b>Notes</b></p> <p>Control Arm Front Axle Right Sheet Steel with ball joint with rubber mount</p> <p>Paired article number Required quantity replacement in pairs recommended</p>		 	
<p><b>References</b></p> <p>Fiat 51959820 Jeep K68248000AA</p>		<p>Jeep 51959820</p>	
<p><b>Application info</b></p> <p>Fiat 500X (09/14--) Jeep Renegade (BU, B1) (07/14--)</p>		<p>Jeep Compass (MP) (01/16--)</p>	
Control arm		216 050 0071	MCA1352
<p><b>Notes</b></p> <p>Control Arm Front Axle Left Sheet Steel with ball joint with rubber mount</p> <p>Paired article number Required quantity replacement in pairs recommended</p>		 	
<p><b>References</b></p> <p>Fiat 51961341</p>		<p>Jeep 51961341</p>	
<p><b>Application info</b></p> <p>Fiat 500X (09/14--) Jeep Renegade (BU, B1) (07/14--)</p>		<p>Jeep Compass (MP) (01/16--)</p>	



Control arm		216 050 0072	MCA1255
<p><b>Notes</b></p> <p>Control Arm Front Axle Right Sheet Steel with ball joint with rubber mount</p> <p>Paired article number Required quantity replacement in pairs recommended</p>			
<p><b>References</b></p> <p>Fiat 51939751 Jeep K68247999AA</p>		<p>Jeep 51939751</p>	
<p><b>Application info</b></p> <p>Fiat 500X (09/14--)</p>		<p>Jeep Renegade (BU, B1) (07/14--)</p>	
Control arm		216 050 0073	MCA1256
<p><b>Notes</b></p> <p>Control Arm Front Axle Left Sheet Steel with ball joint with rubber mount</p> <p>Paired article number Required quantity replacement in pairs recommended</p>			
<p><b>References</b></p> <p>Fiat 51939755</p>		<p>Jeep 51939755</p>	
<p><b>Application info</b></p> <p>Fiat 500X (09/14--)</p>		<p>Jeep Renegade (BU, B1) (07/14--)</p>	

Control arm		216 050 3118	MCA0338
<p><b>Notes</b></p> <p>Control Arm Forged Front Axle Right Lower Steel with rubber mount</p> <p>Paired article number Required quantity replacement in pairs recommended</p>			
<p><b>References</b></p> <p>Fiat 46423823 Fiat 7777240 Lancia 46423823 Lancia 71747916 Lancia 7777240 Lancia 82461082</p>		<p>Fiat 71747916 Fiat 82461082 Lancia 71738286 Lancia 7601062 Lancia 7780444</p>	
<p><b>Application info</b></p> <p>Fiat Brava / Bravo (182) (10/95-06/03) Lancia Dedra (01/89-07/99)</p>		<p>Fiat Tempra / Tipo (07/87-12/98) Lancia Delta I / II (09/79-09/99)</p>	
Control arm		216 050 4671	MCA0339
<p><b>Notes</b></p> <p>Control Arm Front Axle Left Lower Sheet Steel with rubber mount</p> <p>Paired article number Required quantity replacement in pairs recommended</p>			
<p><b>References</b></p> <p>Fiat 5939683</p>		<p>Fiat 7705615</p>	
<p><b>Application info</b></p> <p>Fiat Uno (146A/E/Kasten) (01/83-12/13)</p>			

Control arm		216 050 4672	MCA0340
<p><b>Notes</b></p> <p>Control Arm Front Axle Right Lower Sheet Steel with rubber mount</p> <p>Paired article number Required quantity replacement in pairs recommended</p>			
<p><b>References</b></p> <p>Fiat 5938685 Fiat 7705616</p>		<p>Fiat 5939685</p>	
<p><b>Application info</b></p> <p>Fiat Uno (146A/E/Kasten) (01/83-12/13)</p>			
Control arm		216 050 7504	MCA0341
<p><b>Notes</b></p> <p>Control Arm Forged Front Axle Left Lower Steel with rubber mount</p> <p>Paired article number Required quantity replacement in pairs recommended</p>			
<p><b>References</b></p> <p>Fiat 46423822 Fiat 7777239 Lancia 46423822 Lancia 71747915 Lancia 7777239 Lancia 82461081</p>		<p>Fiat 71747915 Fiat 82461081 Lancia 71738285 Lancia 7601057 Lancia 7780443</p>	
<p><b>Application info</b></p> <p>Fiat Brava / Bravo (182) (10/95-06/03) Lancia Dedra (01/89-07/99)</p> <p>Fiat Tempra / Tipo (07/87-12/98) Lancia Delta I / II (09/79-09/99)</p>			

Control arm		28-16 050 0046/HD	MCA1533HD
<p><b>Notes</b></p> <p>Carbon Neutral Control Arm Front Axle Right Lower Sheet Steel with ball joint with rubber mount</p> <p>Paired article number Replace in pairs only Required quantity reinforced version</p>			
<p>28-16 050 0047/HD   MCA1534HD</p> <p>1</p>			
<p><b>References</b></p> <p>Kia 54501 H8500</p>			
<p><b>Application info</b></p> <p>Kia Stonic (07/17--)</p>			
Control arm		28-16 050 0047/HD	MCA1534HD
<p><b>Notes</b></p> <p>Carbon Neutral Control Arm Front Axle Left Lower Sheet Steel with ball joint with rubber mount</p> <p>Paired article number Replace in pairs only Required quantity reinforced version</p>			
<p>28-16 050 0046/HD   MCA1533HD</p> <p>1</p>			
<p><b>References</b></p> <p>Kia 54500 H8500</p>			
<p><b>Application info</b></p> <p>Kia Stonic (07/17--)</p>			

Control arm		30-16 050 0000	MCA0364
<p><b>Notes</b></p> <p>Control Arm Front Axle Left Lower Sheet Steel with ball joint with rubber mount</p> <p>Paired article number 30-16 050 0016   MCA0372 Required quantity 1 Thread Size M12x1,25 replacement in pairs recommended</p>			
<p><b>References</b></p> <p>Toyota 48069-09015 Toyota 48069-09030 Toyota 48069-59035</p>			
<p><b>Application info</b></p> <p>Toyota Yaris I (01/99-12/05)</p>			
Control arm		30-16 050 0016	MCA0372
<p><b>Notes</b></p> <p>Control Arm Front Axle Right Lower Sheet Steel with ball joint with rubber mount</p> <p>Paired article number 30-16 050 0000   MCA0364 Required quantity 1 Thread Size M12x1,25 replacement in pairs recommended</p>			
<p><b>References</b></p> <p>Toyota 48068-09015 Toyota 48068-09030 Toyota 48068-59035</p>			
<p><b>Application info</b></p> <p>Toyota Yaris I (01/99-12/05)</p>			

Control arm		30-16 050 0026	MCA1206
<p><b>Notes</b></p> <p>Control Arm Front Axle Left Lower Sheet Steel with ball joint with rubber mount</p> <p>Paired article number Required quantity Thread Size replacement in pairs recommended</p>	<p>Control Arm Front Axle Left Lower Sheet Steel with ball joint with rubber mount</p> <p>30-16 050 0027   MCA1207</p> <p>1</p> <p>M12x1,25</p>		
<p><b>References</b></p> <p>Toyota 48069-59055</p>			
<p><b>Application info</b></p> <p>Toyota Yaris I (01/99-12/05)</p>			
Control arm		30-16 050 0027	MCA1207
<p><b>Notes</b></p> <p>Control Arm Front Axle Right Lower Sheet Steel with ball joint with rubber mount</p> <p>Paired article number Required quantity Thread Size replacement in pairs recommended</p>	<p>Control Arm Front Axle Right Lower Sheet Steel with ball joint with rubber mount</p> <p>30-16 050 0026   MCA1206</p> <p>1</p> <p>M12x1,25</p>		
<p><b>References</b></p> <p>Toyota 48068-59055</p>			
<p><b>Application info</b></p> <p>Toyota Yaris I (01/99-12/05)</p>			



## Control arm

30-16 050 0135/HD

MCA1528HD

## Notes

Carbon Neutral  
Control Arm  
Front Axle Left  
Lower  
Steel  
for left-hand drive vehicles  
for right-hand drive vehicles



Bore Diameter [mm]	19.1
Length [mm]	329.3
Paired article number	30-16 050 0136/HD   MCA1529HD
Replace in pairs only	
Required quantity	1
Thread Size	M12x1,25
Width [mm]	291.4
reinforced version	
replacement in pairs recommended	

## References

Citroën 16 141 914 80  
Peugeot 16 14 191 480  
Toyota 48069-0H020

Citroën B0 007 702 80  
Peugeot B0 00 770 280  
Toyota 48069-0H021

## Application info

Citroën C1 II (04/14--)  
Toyota Aygo II (05/14--)

Peugeot 108 (05/14--)

## Control arm

30-16 050 0136/HD

MCA1529HD

## Notes

Aluminium  
Carbon Neutral  
Control Arm  
Front Axle Right  
Lower  
Steel  
for left-hand drive vehicles  
for right-hand drive vehicles



Bore Diameter [mm] 19.1  
Length [mm] 329.3  
Paired article number 30-16 050 0135/HD | MCA1528HD  
Replace in pairs only  
Required quantity 1  
Thread Size M12x1,25  
Width [mm] 291.4  
reinforced version  
replacement in pairs recommended

## References

Citroën 16 141 916 80  
Peugeot 16 14 191 680  
Toyota 48068-0H020

Citroën B0 007 701 80  
Peugeot B0 00 770 180  
Toyota 48068-0H021

## Application info

Citroën C1 II (04/14--)  
Toyota Aygo II (05/14--)

Peugeot 108 (05/14--)

## Control arm

31-16 050 0006/HD

MCA0400HD

## Notes

Aluminium  
Carbon Neutral  
Control Arm  
Front Axle Right  
Lower  
with ball joint  
with rubber mount



Paired article number 31-16 050 0007/HD | MCA0401HD  
Replace in pairs only  
Required quantity 1  
Thread Size M14x2,0  
reinforced version

**References**

Honda 51350-SMG-E01  
 Honda 51350-SMG-E03  
 Honda 51350-SMG-E05  
 Honda 51350-SMG-E07

Honda 51350-SMG-E02  
 Honda 51350-SMG-E04  
 Honda 51350-SMG-E06

**Application info**

Honda Civic VIII (09/05--)

**Control arm**

31-16 050 0007/HD

MCA0401HD

**Notes**

Aluminium  
 Carbon Neutral  
 Control Arm  
 Front Axle Left  
 Lower  
 with ball joint  
 with rubber mount

Paired article number  
 Replace in pairs only  
 Required quantity  
 Thread Size  
 reinforced version

31-16 050 0006/HD | MCA0400HD  
 1  
 M14x2,0



**References**

Honda 51360-SMG-E01  
 Honda 51360-SMG-E03  
 Honda 51360-SMG-E05  
 Honda 51360-SMG-E07

Honda 51360-SMG-E02  
 Honda 51360-SMG-E04  
 Honda 51360-SMG-E06

**Application info**

Honda Civic VIII (09/05--)

**Control arm set** 116 050 0029/HD MCK0005HD

**Notes**

Aluminium  
Carbon Neutral  
Front Axle Left  
Front Axle Right  
with accessories  
with suspension rod

Required quantity  
reinforced version

1



**References**

The references of this product can be found at [www.meyle.com](http://www.meyle.com)

**Application info**

Audi A4 I (8D\_) (11/94-12/02)

Skoda Superb I (3U) (12/01-03/08)

Audi A6 II (4B, C5) (01/97-12/05)

Volkswagen Passat (3B\_) (08/96-12/05)

**Control arm set** 116 050 0030/HD MCK0006HD

**Notes**

Aluminium  
Carbon Neutral  
Front Axle Left  
Front Axle Right  
with accessories  
with suspension rod

Required quantity  
reinforced version

1



**References**

- |                     |                     |
|---------------------|---------------------|
| Audi 4D0 407 151 H  | Audi 4D0 407 151 P  |
| Audi 4D0 407 505 A  | Audi 4D0 407 505 B  |
| Audi 4D0 407 505 D  | Audi 4D0 407 505 F  |
| Audi 4D0 407 505 H  | Audi 4D0 407 505 J  |
| Audi 4D0 407 509 J  | Audi 4D0 407 509 K  |
| Audi 4D0 407 510 J  | Audi 4D0 407 510 K  |
| Audi 4D0 407 693 AC | Audi 4D0 407 693 AD |
| Audi 4D0 407 693 E  | Audi 4D0 407 693 G  |
| Audi 4D0 407 693 H  | Audi 4D0 407 693 K  |
| Audi 4D0 407 693 M  | Audi 4D0 407 693 P  |
| Audi 4D0 407 694 AC | Audi 4D0 407 694 AD |
| Audi 4D0 407 694 E  | Audi 4D0 407 694 G  |
| Audi 4D0 407 694 H  | Audi 4D0 407 694 K  |
| Audi 4D0 407 694 M  | Audi 4D0 407 694 P  |
| Audi 4D0 407 695 J  | Audi 4D0 407 696 J  |
| Audi 4D0 498 998 C  | Audi 8D0 407 151 E  |
| Audi 8D0 407 509 G  | Audi 8D0 407 510 G  |
| Audi 8E0 407 509 A  | Audi 8E0 407 509 C  |
| Audi 8E0 407 509 E  | Audi 8E0 407 509 P  |
| Audi 8E0 407 509 Q  | Audi 8E0 407 510 A  |
| Audi 8E0 407 510 C  | Audi 8E0 407 510 E  |
| Audi 8E0 407 510 P  | Audi 8E0 407 510 Q  |
| Audi 8E0 407 693 AG | Audi 8E0 407 693 K  |
| Audi 8E0 407 693 Q  | Audi 8E0 407 694 AG |
| Audi 8E0 407 694 K  | Audi 8E0 407 694 Q  |

**Application info**

Audi A8 l (4D\_) (03/94-12/05)

**Control arm set**

116 050 0041/HD

MCK0008HD

**Notes**

Aluminium  
Carbon Neutral  
Control Arm  
Front Axle Left  
Front Axle Right  
with accessories  
with suspension rod

Required quantity  
reinforced version

1



**References**

- |                     |                     |
|---------------------|---------------------|
| Audi 4B0 407 151    | Audi 4B3 407 151 A  |
| Audi 4B3 407 151 C  | Audi 4B3 407 151 E  |
| Audi 4B3 407 151 F  | Audi 4B3 407 151 K  |
| Audi 4D0 407 505 A  | Audi 4D0 407 505 B  |
| Audi 4D0 407 505 D  | Audi 4D0 407 505 F  |
| Audi 4D0 407 505 H  | Audi 4D0 407 505 J  |
| Audi 4D0 407 509 J  | Audi 4D0 407 509 K  |
| Audi 4D0 407 510 J  | Audi 4D0 407 510 K  |
| Audi 4D0 407 693 AC | Audi 4D0 407 693 AD |
| Audi 4D0 407 693 E  | Audi 4D0 407 693 G  |
| Audi 4D0 407 693 H  | Audi 4D0 407 693 K  |
| Audi 4D0 407 693 M  | Audi 4D0 407 693 P  |
| Audi 4D0 407 694 AC | Audi 4D0 407 694 AD |
| Audi 4D0 407 694 E  | Audi 4D0 407 694 G  |
| Audi 4D0 407 694 H  | Audi 4D0 407 694 K  |
| Audi 4D0 407 694 M  | Audi 4D0 407 694 P  |
| Audi 4D0 407 695 J  | Audi 4D0 407 696 J  |
| Audi 8D0 407 509 G  | Audi 8D0 407 510 G  |
| Audi 8E0 407 509 A  | Audi 8E0 407 509 C  |
| Audi 8E0 407 509 E  | Audi 8E0 407 509 P  |
| Audi 8E0 407 509 Q  | Audi 8E0 407 510 A  |
| Audi 8E0 407 510 C  | Audi 8E0 407 510 E  |
| Audi 8E0 407 510 P  | Audi 8E0 407 510 Q  |
| Audi 8E0 407 693 AG | Audi 8E0 407 693 K  |
| Audi 8E0 407 693 Q  | Audi 8E0 407 694 AG |
| Audi 8E0 407 694 K  | Audi 8E0 407 694 Q  |

**Application info**

Audi A8 I (4D\_) (03/94-12/05)

**Control arm set**

116 050 0083/HD

MCK0010HD

**Notes**

Carbon Neutral  
Control Arm  
Front Axle Left  
Front Axle Right  
with accessories  
with suspension rod

Required quantity  
reinforced version

1



**References**

Audi 4D0 407 509 J	Audi 4D0 407 510 J
Audi 4D0 407 693 AC	Audi 4D0 407 693 AD
Audi 4D0 407 693 E	Audi 4D0 407 693 H
Audi 4D0 407 693 K	Audi 4D0 407 693 M
Audi 4D0 407 693 N	Audi 4D0 407 693 P
Audi 4D0 407 694 AC	Audi 4D0 407 694 AD
Audi 4D0 407 694 E	Audi 4D0 407 694 H
Audi 4D0 407 694 K	Audi 4D0 407 694 M
Audi 4D0 407 694 N	Audi 4D0 407 694 P
Audi 4F0 419 811 A	Audi 8D0 407 505 E
Audi 8D0 407 505 L	Audi 8D0 407 506 E
Audi 8D0 407 506 L	Audi 8E0 407 151 E
Audi 8E0 407 151 K	Audi 8E0 407 151 L
Audi 8E0 407 151 M	Audi 8E0 407 151 N
Audi 8E0 407 151 R	Audi 8E0 407 505 A
Audi 8E0 407 505 C	Audi 8E0 407 505 E
Audi 8E0 407 505 P	Audi 8E0 407 505 Q
Audi 8E0 407 506 A	Audi 8E0 407 506 C
Audi 8E0 407 506 E	Audi 8E0 407 506 P
Audi 8E0 407 506 Q	Audi 8E0 407 509 A
Audi 8E0 407 509 C	Audi 8E0 407 509 E
Audi 8E0 407 509 P	Audi 8E0 407 509 Q
Audi 8E0 407 510 A	Audi 8E0 407 510 C
Audi 8E0 407 510 E	Audi 8E0 407 510 P
Audi 8E0 407 510 Q	Audi 8E0 407 693
Audi 8E0 407 693 AG	Audi 8E0 407 693 K
Audi 8E0 407 693 Q	Audi 8E0 407 694
Audi 8E0 407 694 AG	Audi 8E0 407 694 K
Audi 8E0 407 694 Q	Audi 8E0 411 317
Audi 8E0 411 318	

**Application info**

Audi A4 Cabriolet (8H_) (01/02-12/09)	Audi A4 II (8E_) (02/00-12/05)
Audi A4 III (8E_) (11/04-06/08)	

**Control arm set**

116 050 0085/HD

MCK0011HD

**Notes**

Carbon Neutral  
Control Arm  
Front Axle Left  
Front Axle Right  
with accessories  
with suspension rod  
1

Required quantity  
reinforced version



**References**

- |                     |                     |
|---------------------|---------------------|
| Audi 4F0 419 811 A  | Audi 8D0 407 505 D  |
| Audi 8D0 407 505 E  | Audi 8D0 407 505 L  |
| Audi 8D0 407 506 D  | Audi 8D0 407 506 E  |
| Audi 8D0 407 506 L  | Audi 8D0 407 509 A  |
| Audi 8D0 407 509 F  | Audi 8D0 407 509 G  |
| Audi 8D0 407 510 A  | Audi 8D0 407 510 F  |
| Audi 8D0 407 510 G  | Audi 8E0 407 151 E  |
| Audi 8E0 407 151 K  | Audi 8E0 407 151 L  |
| Audi 8E0 407 151 M  | Audi 8E0 407 151 N  |
| Audi 8E0 407 151 R  | Audi 8E0 407 505 C  |
| Audi 8E0 407 505 P  | Audi 8E0 407 506 C  |
| Audi 8E0 407 506 E  | Audi 8E0 407 506 P  |
| Audi 8E0 407 506 Q  | Audi 8E0 407 509 A  |
| Audi 8E0 407 509 C  | Audi 8E0 407 509 E  |
| Audi 8E0 407 509 P  | Audi 8E0 407 509 Q  |
| Audi 8E0 407 510 A  | Audi 8E0 407 510 C  |
| Audi 8E0 407 510 E  | Audi 8E0 407 510 P  |
| Audi 8E0 407 510 Q  | Audi 8E0 407 693 AA |
| Audi 8E0 407 693 AC | Audi 8E0 407 693 AJ |
| Audi 8E0 407 693 AK | Audi 8E0 407 693 AL |
| Audi 8E0 407 693 AM | Audi 8E0 407 693 N  |
| Audi 8E0 407 693 T  | Audi 8E0 407 694 AA |
| Audi 8E0 407 694 AC | Audi 8E0 407 694 AJ |
| Audi 8E0 407 694 AK | Audi 8E0 407 694 AL |
| Audi 8E0 407 694 AM | Audi 8E0 407 694 N  |
| Audi 8E0 407 694 T  | Seat 4F0 419 811 A  |
| Seat 8E0 407 151 R  | Seat 8E0 407 505 P  |
| Seat 8E0 407 506 P  | Seat 8E0 407 509 P  |
| Seat 8E0 407 510 P  | Seat 8E0 407 693 AL |
| Seat 8E0 407 694 AL | Seat 8E0 411 317    |
| Seat 8E0 411 318    |                     |



**Application info**

Audi A4 Cabriolet (8H\_) (01/02-12/09)  
 Seat Exeo (3R) (12/08-05/13)

Audi A4 III (8E\_) (11/04-06/08)

**Control arm set**

116 050 0087/HD

MCK0013HD

**Notes**

Aluminium  
 Carbon Neutral  
 Control Arm  
 Front Axle Left  
 Front Axle Right  
 with accessories  
 with suspension rod

Required quantity  
 reinforced version

1



**References**

The references of this product can be found at [www.meyle.com](http://www.meyle.com)

**Application info**

Audi A4 I (8D\_) (11/94-12/02)  
 Skoda Superb I (3U) (12/01-03/08)

Audi A6 II (4B, C5) (01/97-12/05)

Volkswagen Passat (3B\_) (08/96-12/05)

**Control arm set**

116 050 0095/HD

MCK0014HD

**Notes**

Carbon Neutral  
 Control Arm  
 Front Axle Left  
 Front Axle Right  
 with accessories  
 with suspension rod

Full Set  
 Required quantity  
 reinforced version

1

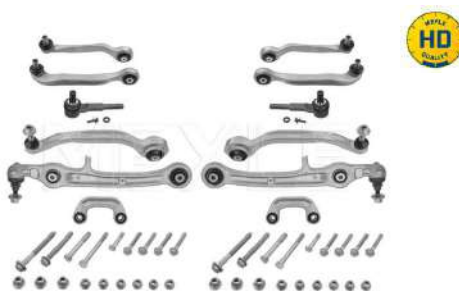

**References**

- |                    |                    |
|--------------------|--------------------|
| Audi 4B0 419 811 G | Audi 4B0 419 811 Q |
| Audi 4D0 419 811 J | Audi 4E0 407 505 B |
| Audi 4E0 407 505 E | Audi 4E0 407 505 F |
| Audi 4E0 407 506 B | Audi 4E0 407 506 E |
| Audi 4E0 407 506 F | Audi 4E0 407 509 B |
| Audi 4E0 407 509 E | Audi 4E0 407 509 F |
| Audi 4E0 407 509 G | Audi 4E0 407 509 H |
| Audi 4E0 407 509 K | Audi 4E0 407 510 B |
| Audi 4E0 407 510 E | Audi 4E0 407 510 F |
| Audi 4E0 407 510 G | Audi 4E0 407 510 H |
| Audi 4E0 407 510 K | Audi 4E0 411 317 C |
| Audi 4E0 411 317 E | Audi 4E0 411 317 F |
| Audi 4F0 407 151   | Audi 4F0 407 151 A |
| Audi 4F0 407 693   | Audi 4F0 407 693 B |
| Audi 4F0 407 693 C | Audi 4F0 407 693 G |
| Audi 4F0 407 693 H | Audi 4F0 407 693 J |
| Audi 4F0 407 694   | Audi 4F0 407 694 B |
| Audi 4F0 407 694 C | Audi 4F0 407 694 G |
| Audi 4F0 407 694 H | Audi 4F0 407 694 J |
| Audi 4F0 419 811 A | Audi 4F0 419 811 C |
| Audi 4F0 419 811 D | Audi 4F0 498 811   |
| Audi 4F0 498 811 A | Audi 4F0 498 811 C |
| Audi 8E0 419 811   |                    |

**Application info**

Audi A6 III (4F2, 4FH, 4F5) (04/04-08/11)

**Control arm set**

116 050 0189/HD

MCK0053HD

**Notes**

Carbon Neutral  
 Front Axle Left  
 Front Axle Right  
 with attachment material

Full Set  
 Required quantity  
 reinforced version

1



**References**

- |                       |                       |
|-----------------------|-----------------------|
| Audi 4G0 407 689 C    | Audi 8K0 407 151 F    |
| Audi 8K0 407 152 F    | Audi 8K0 407 505 A    |
| Audi 8K0 407 505 B    | Audi 8K0 407 505 M    |
| Audi 8K0 407 505 N    | Audi 8K0 407 506 A    |
| Audi 8K0 407 506 B    | Audi 8K0 407 506 M    |
| Audi 8K0 407 506 N    | Audi 8K0 407 509 A    |
| Audi 8K0 407 509 B    | Audi 8K0 407 509 M    |
| Audi 8K0 407 509 N    | Audi 8K0 407 509 P    |
| Audi 8K0 407 510 A    | Audi 8K0 407 510 B    |
| Audi 8K0 407 510 M    | Audi 8K0 407 510 N    |
| Audi 8K0 407 510 P    | Audi 8K0 407 693 Q    |
| Audi 8K0 407 694 Q    | Audi 8K0 411 317 D    |
| Audi 8R0 407 693 D    | Audi 8R0 407 694 D    |
| Porsche 8K0 407 151 F | Porsche 8K0 407 152 F |
| Porsche 8K0 407 505 A | Porsche 8K0 407 506 A |
| Porsche 8K0 407 509 A | Porsche 8K0 407 510 A |
| Porsche 8K0 407 693 Q | Porsche 8K0 407 694 Q |

**Application info**

- |                                |                                     |
|--------------------------------|-------------------------------------|
| Audi A4 IV (8K_) (08/07-05/16) | Audi A5 I (8F_ , 8T_) (06/07-01/17) |
| Audi Q5 I (8R_) (11/08-12/17)  | Porsche Macan (95B) (02/14--)       |

**Control arm set**

116 050 0190/HD

MCK0054HD

**Notes**

Carbon Neutral  
 Front Axle Left  
 Front Axle Right  
 with attachment material

Full Set  
 Required quantity  
 reinforced version

1



**References**

- |                    |                    |
|--------------------|--------------------|
| Audi 4M0 411 317   | Audi 8K0 407 151 C |
| Audi 8K0 407 151 D | Audi 8K0 407 152 C |
| Audi 8K0 407 152 D | Audi 8K0 407 505 A |
| Audi 8K0 407 505 N | Audi 8K0 407 506 A |
| Audi 8K0 407 506 N | Audi 8K0 407 509 A |
| Audi 8K0 407 509 N | Audi 8K0 407 510 A |
| Audi 8K0 407 510 N | Audi 8K0 407 689 G |
| Audi 8K0 407 693 Q | Audi 8K0 407 694 Q |

**Application info**

Audi A4 IV (8K\_) (08/07-05/16)

Audi Q5 I (8R\_) (11/08-12/17)

Audi A5 I (8F\_ , 8T\_) (06/07-01/17)

**Control arm set**

116 050 0190/S

MCK0047

**Notes**

Front Axle Left  
Front Axle Right  
with accessories

Full Set

Required quantity

1

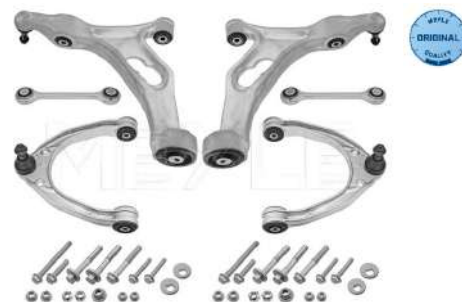

**References**

Audi 7L0 407 021

Audi 7L0 407 021 B

Audi 7L8 407 152 K

Audi 7P0 407 151 C

Audi 7P0 407 151 E

Audi 7P0 407 152 C

Audi 7P0 407 152 E

Audi 7L0 407 021 A

Audi 7L8 407 151 K

Audi 7P0 407 151 B

Audi 7P0 407 151 D

Audi 7P0 407 152 B

Audi 7P0 407 152 D

**Application info**

Audi Q7 I (4L\_) (03/06-01/16)

**Control arm set**

116 050 0191/S

MCK0048

**Notes**

Front Axle Left  
Front Axle Right  
with accessories

Full Set

Required quantity

1



**References**

Audi 7L8 407 021  
 Audi 7L8 407 151 K  
 Audi 7L8 407 152 K  
 Audi 7P0 407 151 C  
 Audi 7P0 407 151 E  
 Audi 7P0 407 152 C  
 Audi 7P0 407 152 E

Audi 7L8 407 151 F  
 Audi 7L8 407 152 F  
 Audi 7P0 407 151 B  
 Audi 7P0 407 151 D  
 Audi 7P0 407 152 B  
 Audi 7P0 407 152 D

**Application info**

Audi Q7 I (4L\_) (03/06-01/16)

**Control arm set**

116 050 0194/HD

MCK0046HD

**Notes**

Carbon Neutral  
 Front Axle Left  
 Front Axle Right  
 with accessories

Full Set  
 Required quantity  
 reinforced version

1

**References**

Audi 7L0 407 021  
 Audi 7L0 407 021 B  
 Audi 7L0 407 151 J  
 Audi 7L0 407 152 F  
 Audi 7L0 407 152 K  
 Porsche 955 341 017 60  
 Porsche 955 341 018 60  
 Porsche 955 341 027 00  
 Porsche 955 341 027 02  
 Volkswagen 7L0 407 021  
 Volkswagen 7L0 407 021 B  
 Volkswagen 7L0 407 151 J  
 Volkswagen 7L0 407 152 F  
 Volkswagen 7L0 407 152 K

Audi 7L0 407 021 A  
 Audi 7L0 407 151 F  
 Audi 7L0 407 151 K  
 Audi 7L0 407 152 J  
 Audi 7L0 411 317  
 Porsche 955 341 017 61  
 Porsche 955 341 018 61  
 Porsche 955 341 027 01  
 Porsche 955 343 069 00  
 Volkswagen 7L0 407 021 A  
 Volkswagen 7L0 407 151 F  
 Volkswagen 7L0 407 151 K  
 Volkswagen 7L0 407 152 J  
 Volkswagen 7L0 411 317

**Application info**

Audi Q7 I (4L\_) (03/06-01/16)  
 Volkswagen Touareg I (7LA, 7L6 ,7L7 ) (10/02-01/13)

Porsche Cayenne I (955) (09/02-12/10)

## Control arm set

116 050 0222

MCK0050

## Notes

Control Arm  
Lower  
Rear Axle Left  
Rear Axle Right  
Sheet Steel

Required quantity

1



## References

Audi 1K0 505 311 AB

Seat 1K0 505 311 AA

Skoda 1K0 505 311 AB

Volkswagen 1K0 505 311 AA

Volkswagen 1K0 505 311 H

Volkswagen 1K0 505 311 R

Volkswagen 1K0 505 311 T

Audi (FAW) 1K0 505 311 AB

Seat 1K0 505 311 AB

Skoda 1K0 505 311 S

Volkswagen 1K0 505 311 AB

Volkswagen 1K0 505 311 J

Volkswagen 1K0 505 311 S

Volkswagen 1K0 506 311 S

## Application info

Audi A1 I (8X\_) (05/10-10/18)

Audi Q3 I (8U\_) (06/11-12/18)

Seat Leon II / Toledo III / Altea (1P\_ ,5P\_) (03/04--)

Skoda Superb II (3T) (03/08-05/15)

Volkswagen Beetle (5C1) (04/11-07/19)

Volkswagen Eos (03/06-08/15)

Volkswagen Golf VI (5K1, 517, AJ5) (10/08-05/16)

Volkswagen Jetta IV (162) (01/08--)

Volkswagen Passat (3C\_) (03/05-01/12)

Volkswagen Scirocco III (137) (05/08-11/17)

Volkswagen Touran I (1T1/2/3) (02/03-05/15)

Audi A3 II (8P\_) (05/03-12/15)

Audi TT II (8J\_) (07/06-01/15)

Skoda Octavia II (1Z\_) (02/04-06/13)

Skoda Yeti (5L) (05/09-12/17)

Volkswagen CC (11/11-12/16)

Volkswagen Golf V (1K1, 1K5, 5M1) (10/03-08/14)

Volkswagen Jetta III (1K2) (09/04-12/13)

Volkswagen Passat (362, 365) (08/10-12/15)

Volkswagen Passat (A32) (01/11--)

Volkswagen Tiguan I (5N) (09/07-07/18)

## Control arm set

116 050 0222/HD

MCK0050HD

## Notes

Carbon Neutral  
 Front Axle Left  
 Front Axle Right  
 with attachment material

Full Set  
 Required quantity  
 reinforced version

1



## References

Audi 4G0 411 317  
 Audi 4H0 411 317 A  
 Audi 4M0 411 317  
 Audi 8K0 407 151 C  
 Audi 8K0 407 152 B  
 Audi 8K0 407 152 D  
 Audi 8K0 407 505 N  
 Audi 8K0 407 506 N  
 Audi 8K0 407 509 N  
 Audi 8K0 407 510 N  
 Audi 8K0 407 689 E  
 Audi 8K0 407 689 G  
 Audi 8K0 407 693 F  
 Audi 8K0 407 693 K  
 Audi 8K0 407 693 R  
 Audi 8K0 407 694 F  
 Audi 8K0 407 694 K  
 Audi 8K0 407 694 R  
 Audi 8K0 411 317 D

Audi 4G0 411 317 A  
 Audi 4H0 411 317 C  
 Audi 8K0 407 151 B  
 Audi 8K0 407 151 D  
 Audi 8K0 407 152 C  
 Audi 8K0 407 505 A  
 Audi 8K0 407 506 A  
 Audi 8K0 407 509 A  
 Audi 8K0 407 510 A  
 Audi 8K0 407 689 D  
 Audi 8K0 407 689 F  
 Audi 8K0 407 693 AE  
 Audi 8K0 407 693 H  
 Audi 8K0 407 693 N  
 Audi 8K0 407 694 AE  
 Audi 8K0 407 694 H  
 Audi 8K0 407 694 N  
 Audi 8K0 411 317 C  
 Audi 8K0 411 317 E

## Application info

Audi A4 IV (8K\_) (08/07-05/16)  
 Audi Q5 I (8R\_) (11/08-12/17)

Audi A5 I (8F\_ , 8T\_) (06/07-01/17)

**Control arm set**

116 050 0223/HD

MCK0051HD

**Notes**

Carbon Neutral  
 Front Axle Left  
 Front Axle Right  
 with attachment material

Full Set  
 Required quantity  
 reinforced version

1



**References**

- |                     |                     |
|---------------------|---------------------|
| Audi 4G0 411 317    | Audi 4G0 411 317 A  |
| Audi 4H0 411 317 A  | Audi 4H0 411 317 C  |
| Audi 4M0 411 317    | Audi 4M0 411 317 J  |
| Audi 8K0 407 151 B  | Audi 8K0 407 151 C  |
| Audi 8K0 407 151 D  | Audi 8K0 407 152 B  |
| Audi 8K0 407 152 C  | Audi 8K0 407 152 D  |
| Audi 8K0 407 505 A  | Audi 8K0 407 505 J  |
| Audi 8K0 407 505 M  | Audi 8K0 407 505 N  |
| Audi 8K0 407 506 A  | Audi 8K0 407 506 J  |
| Audi 8K0 407 506 M  | Audi 8K0 407 506 N  |
| Audi 8K0 407 509 A  | Audi 8K0 407 509 B  |
| Audi 8K0 407 509 J  | Audi 8K0 407 509 M  |
| Audi 8K0 407 509 N  | Audi 8K0 407 510 A  |
| Audi 8K0 407 510 B  | Audi 8K0 407 510 J  |
| Audi 8K0 407 510 M  | Audi 8K0 407 510 N  |
| Audi 8K0 407 689 D  | Audi 8K0 407 689 E  |
| Audi 8K0 407 689 F  | Audi 8K0 407 689 G  |
| Audi 8K0 407 693 AF | Audi 8K0 407 693 S  |
| Audi 8K0 407 693 T  | Audi 8K0 407 694 AF |
| Audi 8K0 407 694 S  | Audi 8K0 407 694 T  |
| Audi 8K0 411 317 C  | Audi 8K0 411 317 D  |
| Audi 8K0 411 317 E  |                     |

**Application info**

- |                                |                                     |
|--------------------------------|-------------------------------------|
| Audi A4 IV (8K_) (08/07-05/16) | Audi A5 I (8F_ , 8T_) (06/07-01/17) |
| Audi Q5 I (8R_) (11/08-12/17)  |                                     |



**Control arm set**

116 050 0233/S

MCK0049

**Notes**

Front Axle Left  
Front Axle Right  
with attachment material

Full Set  
Required quantity

1



**References**

Porsche 955 341 017 30  
Porsche 955 341 017 33  
Porsche 955 341 018 32  
Porsche 955 341 027 00  
Porsche 955 343 069 00  
Volkswagen 7L0 407 021 A  
Volkswagen 7L0 407 151 C  
Volkswagen 7L0 407 151 H  
Volkswagen 7L0 407 152 E  
Volkswagen 7L0 411 317

Porsche 955 341 017 32  
Porsche 955 341 018 30  
Porsche 955 341 018 33  
Porsche 955 341 027 01  
Volkswagen 7L0 407 021  
Volkswagen 7L0 407 021 B  
Volkswagen 7L0 407 151 E  
Volkswagen 7L0 407 152 C  
Volkswagen 7L0 407 152 H

**Application info**

Porsche Cayenne I (955) (09/02-12/10)

Volkswagen Touareg I (7LA, 7L6 ,7L7 ) (10/02-01/13)

**Control arm set**

116 050 0263/HD

MCK0055HD

**Notes**

Carbon Neutral  
Front Axle Left  
Front Axle Right  
with attachment material

Full Set  
Required quantity  
reinforced version

1

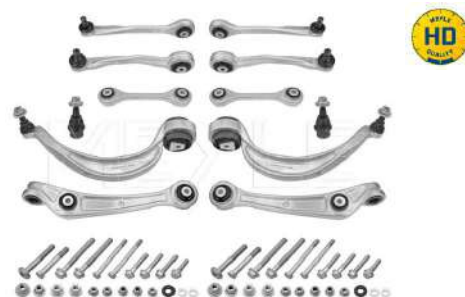

**References**

- |                    |                    |
|--------------------|--------------------|
| Audi 4G0 407 689 A | Audi 4G0 407 689 C |
| Audi 4G0 407 693 D | Audi 4G0 407 693 E |
| Audi 4G0 407 693 F | Audi 4G0 407 693 G |
| Audi 4G0 407 693 H | Audi 4G0 407 693 J |
| Audi 4G0 407 693 K | Audi 4G0 407 693 L |
| Audi 4G0 407 694 D | Audi 4G0 407 694 E |
| Audi 4G0 407 694 F | Audi 4G0 407 694 G |
| Audi 4G0 407 694 J | Audi 4G0 407 694 K |
| Audi 4G0 407 694 L | Audi 4G0 411 317   |
| Audi 4G0 411 317 A | Audi 4H0 411 317 A |
| Audi 4H0 411 317 C | Audi 4M0 411 317   |
| Audi 4M0 411 317 J | Audi 8K0 407 151 F |
| Audi 8K0 407 152 F | Audi 8K0 407 505 J |
| Audi 8K0 407 505 M | Audi 8K0 407 505 R |
| Audi 8K0 407 506 A | Audi 8K0 407 506 J |
| Audi 8K0 407 506 M | Audi 8K0 407 506 R |
| Audi 8K0 407 509 J | Audi 8K0 407 509 M |
| Audi 8K0 407 509 R | Audi 8K0 407 510 J |
| Audi 8K0 407 510 M | Audi 8K0 407 510 R |
| Audi 8K0 411 317 C | Audi 8K0 411 317 D |
| Audi 8K0 411 317 E |                    |

**Application info**

- |   |   |
|---|---|
| Audi A6 IV (4G2, 4G5, C7) (11/10-09/18) | Audi A7 I Sportback (4G_) (07/10-05/18) |
|---|---|

**Control arm set**

216 050 0076/HD

MCK0060HD

**Notes**

Carbon Neutral  
Control Arm  
Front Axle Left  
Front Axle Right  
Steel  
with attachment material

Full Set  
Required quantity  
reinforced version

1



**References**

- |                 |                 |
|-----------------|-----------------|
| ABARTH 51857022 | ABARTH 51860383 |
| Fiat 51857022   | Fiat 51860383   |
| Ford 1 540 244  | Ford 1 540 246  |

**Application info**

ABARTH 500 (01/08--)  
Ford KA II (10/08-05/16)

Fiat 500 (07/07--)

**Mount, axle carrier****300 331 7108****MCX0573****Notes**

Rear  
Rear Axle  
Rubber-Metal Mount

Height [mm] 58.5  
Inner Diameter [mm] 14  
Outer Diameter [mm] 69  
Required quantity 1  
replacement in pairs recommended

**References**

BMW 1 096 207  
BMW 33 17 6 770 456

BMW 33 17 1 096 207  
BMW 6 770 456

**Application info**

BMW X5 (E53) (01/00-12/06)

**Mount, axle carrier****314 710 0008****MCX0528****Notes**

Centre  
Rear Axle Left  
Rear Axle Right  
Rubber-Metal Mount

Height [mm] 54  
Inner Diameter [mm] 12  
Outer Diameter [mm] 53  
Required quantity 2  
replacement in pairs recommended

**References**

BMW 33 17 6 767 525  
BMW (Brilliance) 33 17 6 767 525

BMW 6 767 525  
BMW (Brilliance) 6 767 525

**Application info**

BMW 5 (E60, E61) (12/01-12/10)

BMW 6 (E63, E64) (09/03-12/10)

**Mount, axle carrier** **314 710 0020** **MCX0544**

**Notes**

Front  
Rear Axle Left  
Rear Axle Right  
Rubber-Metal Mount

Height [mm] 92  
Inner Diameter [mm] 18.8  
Outer Diameter [mm] 98  
Required quantity 2  
replacement in pairs recommended



**References**

BMW 33 31 6 775 780	BMW 33 31 6 790 573
BMW 6 775 780	BMW 6 790 573
BMW (Brilliance) 33 31 6 790 573	BMW (Brilliance) 6 790 573

**Application info**

BMW 5 (F07) (01/09-02/17)	BMW 5 (F10, F11) (01/09-02/17)
BMW 6 (F12, F13) (12/10-10/18)	BMW 7 (F01, F02, F03, F04) (02/08-12/15)

**Mount, axle carrier** **314 710 0021** **MCX0541**

**Notes**

Rear  
Rear Axle Left  
Rear Axle Right  
Rubber-Metal Mount

Height [mm] 92  
Inner Diameter [mm] 18.8  
Outer Diameter [mm] 98  
Required quantity 2  
replacement in pairs recommended



**References**

BMW 33 31 6 775 792	BMW 33 31 6 793 864
BMW 6 775 792	BMW 6 793 864
BMW (Brilliance) 33 31 6 793 864	BMW (Brilliance) 6 793 864

**Application info**

BMW 5 (F07) (01/09-02/17)	BMW 5 (F10, F11) (01/09-02/17)
BMW 6 (F12, F13) (12/10-10/18)	BMW 7 (F01, F02, F03, F04) (02/08-12/15)

## Mount, axle carrier

314 710 0022

MCX0549

## Notes

Front  
Rear  
Rear Axle Left  
Rear Axle Right  
Rubber-Metal Mount

Height [mm] 95  
Inner Diameter [mm] 19.5  
Outer Diameter [mm] 78  
Required quantity 4  
replacement in pairs recommended



## References

BMW 33 31 6 764 904  
BMW 6 764 904  
BMW (Brilliance) 33 31 6 770 826

BMW 33 31 6 770 826  
BMW 6 770 826  
BMW (Brilliance) 6 770 826

## Application info

BMW 5 (E60, E61) (12/01-12/10)

BMW 6 (E63, E64) (09/03-12/10)

## Mount, axle carrier

314 710 0024/HD

MCX0600HD

## Notes

Carbon Neutral  
Rear  
Rear Axle

Height [mm] 54  
Inner Diameter [mm] 12  
Outer Diameter [mm] 50  
Replace in pairs only  
Required quantity 2  
reinforced version



## References

BMW 33 31 6 769 376  
BMW (Brilliance) 33 31 6 769 376

BMW 6 769 376  
BMW (Brilliance) 6 769 376

## Application info

BMW 1 (E81, E82, E87, E88) (02/03-12/13)  
BMW 2 (F22,F23) (10/12--)  
BMW 3 (F30, F31) (11/11-06/19)  
BMW 4 (F32, F33, F36) (07/13--)

BMW 1 (F20, F21) (07/11--)  
BMW 3 (E90, E91, E92, E93) (02/04-12/13)  
BMW 3 (F34) (07/12--)  
BMW X1 (E84) (03/09-06/15)

**Mount, axle rod**

16-14 711 0000

MAM0033

**Notes**

Front  
Lower  
Rear  
Rear Axle Left  
Rear Axle Right

Height [mm] 40  
Inner Diameter [mm] 14.1  
Outer Diameter [mm] 33.8  
Required quantity 4  
replacement in pairs recommended



**References**

Dacia 8200839121

Renault 8200839121

**Application info**

Dacia Duster I (04/10--)

Renault Duster I (01/11--)

**Mount, axle rod**

300 333 2102

MAM0022

**Notes**

Lower  
Rear Axle Left  
Rear Axle Right  
inner

Height [mm] 57  
Inner Diameter [mm] 12  
Outer Diameter [mm] 38  
Required quantity 2  
replacement in pairs recommended



**References**

BMW 1 092 248

BMW 1 138 383

BMW 33 32 1 092 248

BMW 33 32 1 138 383

BMW 33 32 6 770 824

BMW 6 770 824

BMW (Brilliance) 33 32 6 770 824

BMW (Brilliance) 6 770 824

**Application info**

BMW 3 (E36) (09/90-08/00)

BMW 3 (E46) (12/97-12/07)

BMW X3 (E83) (01/03-12/11)

BMW Z1 (06/88-06/91)

BMW Z4 (E85) (09/02-12/09)

BMW Z4 (E86) (03/06-01/09)

BMW Z4 (E89) (02/09-08/16)

**Mount, axle rod** **300 333 2103** **MAM0023**

**Notes**

Lower  
Rear Axle Left  
Rear Axle Right  
outer

Height [mm] 57  
Inner Diameter [mm] 12  
Outer Diameter [mm] 46  
Required quantity 2  
replacement in pairs recommended



**References**

BMW 1 136 311	BMW 33 32 1 136 311
BMW 33 32 6 771 828	BMW 6 771 828
BMW (Brilliance) 33 32 6 771 828	BMW (Brilliance) 6 771 828

**Application info**

BMW 3 (E36) (09/90-08/00)	BMW 3 (E46) (12/97-12/07)
BMW X3 (E83) (01/03-12/11)	BMW Z1 (06/88-06/91)
BMW Z4 (E85) (09/02-12/09)	BMW Z4 (E86) (03/06-01/09)
BMW Z4 (E89) (02/09-08/16)	

**Mount, axle rod** **314 710 0009** **MAM0038**

**Notes**

Front  
Rear Axle Left  
Rear Axle Right  
Upper  
inner

Height [mm] 48  
Inner Diameter [mm] 12  
Outer Diameter [mm] 39  
Required quantity 2  
replacement in pairs recommended



**References**

BMW 33 32 6 792 539	BMW 33 32 6 792 540
BMW 6 792 539	BMW 6 792 540
BMW (Brilliance) 33 32 6 792 539	BMW (Brilliance) 33 32 6 792 540
BMW (Brilliance) 6 792 539	BMW (Brilliance) 6 792 540

**Application info**

BMW 1 (F20, F21) (07/11--)

BMW 3 (F30, F31) (11/11-06/19)

BMW 4 (F32, F33, F36) (07/13--)

BMW 2 (F22,F23) (10/12--)

BMW 3 (F34) (07/12--)

**Mount, axle rod**

314 710 0010

MAM0039

**Notes**

Front  
Rear Axle Left  
Rear Axle Right  
Upper  
outer

Height [mm]

48

Inner Diameter [mm]

12

Outer Diameter [mm]

43

Required quantity

2

replacement in pairs recommended



**References**

BMW 33 32 6 792 539

BMW 6 792 539

BMW (Brilliance) 33 32 6 792 539

BMW (Brilliance) 6 792 539

BMW 33 32 6 792 540

BMW 6 792 540

BMW (Brilliance) 33 32 6 792 540

BMW (Brilliance) 6 792 540

**Application info**

BMW 1 (F20, F21) (07/11--)

BMW 3 (F30, F31) (11/11-06/19)

BMW 4 (F32, F33, F36) (07/13--)

BMW 2 (F22,F23) (10/12--)

BMW 3 (F34) (07/12--)

**Mount, axle rod**

314 710 0012

MAM0040

**Notes**

Rear  
Rear Axle Left  
Rear Axle Right  
Upper  
inner

Height [mm]

48

Inner Diameter [mm]

12

Outer Diameter [mm]

38

Required quantity

2

replacement in pairs recommended





**References**

BMW 33 32 6 792 543

BMW 6 792 543

BMW (Brilliance) 33 32 6 792 543

BMW (Brilliance) 6 792 543

BMW 33 32 6 792 544

BMW 6 792 544

BMW (Brilliance) 33 32 6 792 544

BMW (Brilliance) 6 792 544

**Application info**

BMW 1 (F20, F21) (07/11--)

BMW 3 (F30, F31) (11/11-06/19)

BMW 4 (F32, F33, F36) (07/13--)

BMW 2 (F22,F23) (10/12--)

BMW 3 (F34) (07/12--)

**Mount, control arm**

15-14 610 0000

MCB0139

**Notes**

Front Axle Left  
 Front Axle Right  
 Rear  
 Rubber-Metal Mount  
 Upper  
 without holder

Height [mm]

38

Inner Diameter [mm]

10

Outer Diameter [mm]

52

Required quantity

2

replacement in pairs recommended

**References**

Alfa Romeo 51776326

Alfa Romeo 51834093

Alfa Romeo 60651939

Alfa Romeo 60657245

Alfa Romeo 60666787

Alfa Romeo 51776327

Alfa Romeo 51834094

Alfa Romeo 60651940

Alfa Romeo 60657246

Alfa Romeo 60666789

**Application info**

Alfa Romeo 147 (10/00-12/10)

Alfa Romeo GT (937) (11/03-09/10)

Alfa Romeo 156 (02/97-05/06)

**Mount, control arm**

15-14 610 0002

MCB0140

**Notes**

Front Axle Left  
 Front Axle Right  
 Lower  
 Rubber-Metal Mount  
 outer  
 without holder

Height [mm] 76  
 Inner Diameter [mm] 14  
 Outer Diameter [mm] 42  
 Required quantity 2  
 replacement in pairs recommended



**References**

- |                     |                     |
|---------------------|---------------------|
| Alfa Romeo 50704306 | Alfa Romeo 50704307 |
| Alfa Romeo 50706858 | Alfa Romeo 50706859 |
| Alfa Romeo 50707029 | Alfa Romeo 50707030 |
| Alfa Romeo 50707316 | Alfa Romeo 50707317 |
| Alfa Romeo 51795446 | Alfa Romeo 51795447 |
| Alfa Romeo 51805471 | Alfa Romeo 51805472 |
| Alfa Romeo 71749327 | Alfa Romeo 71749328 |

**Application info**

- |                                       |                                |
|---------------------------------------|--------------------------------|
| Alfa Romeo 159 (06/05-12/12)          | Alfa Romeo Brera (01/06-05/11) |
| Alfa Romeo Spider (939) (03/06-03/11) |                                |

**Mount, control arm**

15-14 610 0004

MCM0037

**Notes**

Front Axle Right  
 Rear  
 inner

Height [mm] 61  
 Inner Diameter [mm] 30  
 Paired article number 15-14 610 0005 | MCM0038  
 Required quantity 1  
 replacement in pairs recommended



**References**

- |                     |                     |
|---------------------|---------------------|
| Alfa Romeo 50706955 | Alfa Romeo 50708722 |
|---------------------|---------------------|

**Application info**

Alfa Romeo 159 (06/05-12/12)

Alfa Romeo Brera (01/06-05/11)

Alfa Romeo Spider (939) (03/06-03/11)

**Mount, control arm**

15-14 610 0005

MCM0038

**Notes**

Front Axle Left

Rear

inner

with holder

Height [mm]

61

Inner Diameter [mm]

30

Paired article number

15-14 610 0004 | MCM0037

Required quantity

1

replacement in pairs recommended

**References**

Alfa Romeo 50706954

Alfa Romeo 50708721

**Application info**

Alfa Romeo 159 (06/05-12/12)

Alfa Romeo Brera (01/06-05/11)

Alfa Romeo Spider (939) (03/06-03/11)

**Mount, control arm**

16-14 081 9929

MCB0145

**Notes**

Front Axle Left

Front Axle Right

Lower

without holder

Height [mm]

46

Inner Diameter [mm]

12

Outer Diameter [mm]

36

Required quantity

2

replacement in pairs recommended

**References**

AIXAM 52023508

Renault 7700819929

Renault 7700820921

Renault 8200651164

**Application info**

Renault Twingo I (03/93-10/12)

Mount, control arm		16-14 083 1364	MCB0146
<b>Notes</b>  Front Axle Left Front Axle Right Lower without holder  Height [mm] 46 Inner Diameter [mm] 12 Outer Diameter [mm] 38 Required quantity 2 replacement in pairs recommended			
<b>References</b> Renault 7700819928 Renault 7700831365		Renault 7700831364 Renault 8200651168	
<b>Application info</b> Renault Twingo I (03/93-10/12)			
Mount, control arm		16-14 610 0000	MCB0147
<b>Notes</b>  Front Axle Left Front Axle Right Lower without holder  Height [mm] 46 Inner Diameter [mm] 12 Outer Diameter [mm] 37 Outer Diameter [mm] 50 Required quantity 2 replacement in pairs recommended			

**References**

Dacia 545000794R  
 Dacia 545011362R  
 Dacia 6001549181  
 Dacia 6001550911  
 Dacia 6040002245  
 Dacia 8200749461  
 Dacia 8200792640  
 Dacia 8200910717  
 Renault 545004269R  
 Renault 545019294R  
 Renault 6001549182  
 Renault 6001550912  
 Renault 8200910717

Dacia 545004269R  
 Dacia 545019294R  
 Dacia 6001549182  
 Dacia 6001550912  
 Dacia 8200749459  
 Dacia 8200792639  
 Dacia 8200910716  
 Renault 545000794R  
 Renault 545011362R  
 Renault 6001549181  
 Renault 6001550911  
 Renault 8200910716

**Application info**

Dacia Dokker (11/12--)  
 Dacia Logan I (08/04--)  
 Dacia Sandero I (06/08--)  
 Renault Dokker (12/13--)  
 Renault Logan I (09/04--)  
 Renault Megane III (11/08--)  
 Renault Sandero/Stepway II (11/13--)

Dacia Lodgy (03/12--)  
 Dacia Logan II (10/12--)  
 Dacia Sandero II (10/12--)  
 Renault Lodgy (JS\_) (07/13--)  
 Renault Logan II (09/12--)  
 Renault Sandero/Stepway I (11/07--)  
 Renault Thalia III (12/13--)

**Mount, control arm****16-14 610 0001****MCB0148****Notes**

Front  
 Front Axle Left  
 Front Axle Right  
 Lower  
 without holder

Height [mm] 50  
 Inner Diameter [mm] 18  
 Outer Diameter [mm] 55  
 Required quantity 2  
 replacement in pairs recommended



**References**

GENERAL MOTORS 91166461  
 Nissan 54502-00Q0A  
 Nissan 54502-00QAA  
 Nissan 54503-00Q0B  
 Opel 44 08 959  
 Renault 8200049624  
 Vauxhall 44 12 936

GENERAL MOTORS 93851118  
 Nissan 54502-00Q0B  
 Nissan 54503-00Q0A  
 Nissan 54503-00QAA  
 Opel 44 12 936  
 Vauxhall 44 08 959

**Application info**

Nissan Primastar I (X83) (03/01--)  
 Renault Trafic II (03/01--)

Opel Vivaro A (08/01--)  
 Vauxhall Vivaro A (08/01-07/14)

**Mount, control arm**

16-14 610 0002

MCB0149

**Notes**

Front Axle Left  
 Front Axle Right  
 Lower  
 Rear  
 without holder

Height [mm] 54  
 Inner Diameter [mm] 15  
 Outer Diameter [mm] 58  
 Required quantity 2  
 replacement in pairs recommended



**References**

GENERAL MOTORS 91166461  
 Mercedes-Benz 415 330 02 00  
 Mercedes-Benz A 415 330 02 00  
 Nissan 54502-00Q0A  
 Nissan 54502-00QAA  
 Nissan 54503-00Q0B  
 Opel 44 08 959  
 Renault 545041876R  
 Renault 545058191R  
 Renault 8200041166  
 Renault 8200586567  
 Vauxhall 44 08 959

GENERAL MOTORS 93851118  
 Mercedes-Benz 415 330 03 00  
 Mercedes-Benz A 415 330 03 00  
 Nissan 54502-00Q0B  
 Nissan 54503-00Q0A  
 Nissan 54503-00QAA  
 Opel 44 12 936  
 Renault 545044506R  
 Renault 8200002869  
 Renault 8200586561  
 Renault 8200586570  
 Vauxhall 44 12 936

**Application info**

Nissan Primastar I (X83) (03/01--)  
 Renault Espace IV (11/02--)  
 Renault Trafic II (03/01--)  
 Vauxhall Vivaro A (08/01-07/14)

Opel Vivaro A (08/01--)  
 Renault Laguna II (03/01-12/07)  
 Renault Vel Satis (06/02--)

**Mount, control arm**

16-14 610 0003

MCB0150

**Notes**

Front  
 Front Axle Left  
 Front Axle Right  
 Lower  
 without holder

Height [mm] 50  
 Inner Diameter [mm] 18  
 Outer Diameter [mm] 55  
 Required quantity 2  
 replacement in pairs recommended



**References**

Renault 8200002868

**Application info**

Renault Espace IV (11/02--)  
 Renault Vel Satis (06/02--)

Renault Laguna II (03/01-12/07)

**Mount, control arm**

16-14 610 0004

MCB0151

**Notes**

Front  
 Front Axle Left  
 Front Axle Right  
 Lower  
 without holder

Height [mm] 55  
 Inner Diameter [mm] 12  
 Outer Diameter [mm] 40  
 Required quantity 2  
 replacement in pairs recommended



**References**

Nissan 54560-AX600

Renault 8200183569

**Application info**

Nissan Micra (K12) (03/02--)  
Renault Clio III / Modus (09/04--)

Nissan Note I (01/05-08/13)

**Mount, control arm**

16-14 610 0005

MCB0152

**Notes**

Front Axle Left  
Front Axle Right  
Lower  
Rear  
without holder

Height [mm] 53  
Inner Diameter [mm] 12  
Outer Diameter [mm] 58  
Required quantity 2  
replacement in pairs recommended

**References**

Renault 8200183570

**Application info**

Renault Clio III / Modus (09/04--)

**Mount, control arm**

16-14 610 0006

MCB0153

**Notes**

Front Axle Left  
Front Axle Right  
Lower  
Rear  
without holder

Height [mm] 53  
Inner Diameter [mm] 12  
Outer Diameter [mm] 58  
Required quantity 2  
replacement in pairs recommended





**References**

Mercedes-Benz 415 330 02 00  
 Mercedes-Benz A 415 330 02 00  
 Renault 545041876R  
 Renault 545046162R  
 Renault 545048506R  
 Renault 545050399R  
 Renault 545052354R  
 Renault 545058191R  
 Renault 8200586561  
 Renault 8200586570

Mercedes-Benz 415 330 03 00  
 Mercedes-Benz A 415 330 03 00  
 Renault 545044506R  
 Renault 545046817R  
 Renault 545049968R  
 Renault 545050510R  
 Renault 545055711R  
 Renault 8200041166  
 Renault 8200586567

**Application info**

Mercedes-Benz BM 415 (Citan) (11/12--)  
 Renault Clio IV (11/12--)  
 Renault Mégane II (07/01--)  
 Renault Zoe (06/12--)

Renault Captur I (06/13--)  
 Renault Kangoo II (02/08--)  
 Renault Scénic II (06/03-07/10)

**Mount, control arm****16-14 610 0007****MCB0154****Notes**

Front  
 Front Axle Left  
 Front Axle Right  
 Lower  
 without holder

Height [mm] 49  
 Inner Diameter [mm] 12  
 Outer Diameter [mm] 32  
 Quantity per axle 2  
 Required quantity 2  
 replacement in pairs recommended



**References**

Mercedes-Benz 415 330 02 00  
 Mercedes-Benz A 415 330 02 00  
 Renault 545014120R  
 Renault 545042644R  
 Renault 545046162R  
 Renault 545048506R  
 Renault 545049968R  
 Renault 545050510R  
 Renault 545055165R  
 Renault 545058191R  
 Renault 8200586561  
 Renault 8200586567

Mercedes-Benz 415 330 03 00  
 Mercedes-Benz A 415 330 03 00  
 Renault 545041876R  
 Renault 545044506R  
 Renault 545046817R  
 Renault 545048658R  
 Renault 545050399R  
 Renault 545052354R  
 Renault 545055711R  
 Renault 8200242025  
 Renault 8200586564

**Application info**

Mercedes-Benz BM 415 (Citan) (11/12--)  
 Renault Clio IV (11/12--)  
 Renault Mégane II (07/01--)  
 Renault Zoe (06/12--)

Renault Captur I (06/13--)  
 Renault Kangoo II (02/08--)  
 Renault Scénic II (06/03-07/10)

**Mount, control arm****16-14 610 0008****MCB0155****Notes**

Front Axle Left  
 Front Axle Right  
 Lower  
 Rear  
 without holder

Height [mm] 55  
 Inner Diameter [mm] 12  
 Outer Diameter [mm] 58  
 Required quantity 2  
 replacement in pairs recommended

**References**

Renault 7700824042

**Application info**

Renault Laguna I (11/93-08/02)

## Mount, control arm

16-14 610 0011

MCB0158

## Notes

Front  
Front Axle Left  
Front Axle Right  
Lower  
without holder

Height [mm] 55  
Inner Diameter [mm] 18  
Outer Diameter [mm] 55  
Required quantity 2  
replacement in pairs recommended



## References

Renault 6025307746

Renault 7700822503

## Application info

Renault Avantime (09/01-05/03)  
Renault Laguna I (11/93-08/02)

Renault Espace III (11/96-10/02)  
Renault Vel Satis (06/02--)

## Mount, control arm

16-14 610 0013/HD

MCB0160HD

## Notes

Carbon Neutral  
Front Axle Left  
Front Axle Right  
Lower  
inner  
without holder

Height [mm] 46  
Inner Diameter [mm] 12  
Outer Diameter [mm] 45  
Replace in pairs only  
Required quantity 2  
reinforced version



## References

Nissan 54560-00Q0A  
Renault 7700424399  
Renault 8200651161  
Renault 8200763301  
Renault 8200942396  
Renault 8200942406

Nissan 54560-00QAB  
Renault 7700424459  
Renault 8200763296  
Renault 8200942392  
Renault 8200942405

**Application info**

Nissan Kubistar (08/03--)  
Renault Kangoo I (08/97--)

Renault Clio II / Thalia (02/98--)  
Renault Twingo II / Wind (03/07--)

**Mount, control arm****16-14 610 0014/HD****MCB0161HD****Notes**

Carbon Neutral  
Front Axle Left  
Front Axle Right  
Lower  
inner  
without holder

Height [mm]

46

Inner Diameter [mm]

12

Outer Diameter [mm]

45

Replace in pairs only

Required quantity

2

reinforced version

**References**

Renault 7700789478  
Renault 8200610363

Renault 7700840741  
Renault 8200651163

**Application info**

Renault Mégane I / Scénic I (08/95-07/10)

Renault R 19 (01/88-08/03)

**Mount, control arm****16-14 610 0020****MCB0165****Notes**

Front  
Front Axle Left  
Front Axle Right  
inner  
without holder

Height [mm]

53

Inner Diameter [mm]

18

Outer Diameter [mm]

55

Required quantity

2

replacement in pairs recommended

**References**

Renault 545000001R  
Renault 545010008R  
Renault 545010012R

Renault 545000002R  
Renault 545010009R

**Application info**

Renault Laguna III / Coupe / Grandtour (10/07-12/15)

**Mount, control arm**

16-14 610 0024

MCB0167

**Notes**

Front  
 Front Axle Left  
 Front Axle Right  
 inner  
 without holder

Height [mm] 50  
 Inner Diameter [mm] 18  
 Outer Diameter [mm] 55  
 Required quantity 2  
 replacement in pairs recommended

**References**

Nissan 54504-00Q0D  
 Renault 545000399R  
 Renault 545008682R  
 Renault 545009574R  
 Renault 545014055R  
 Renault 545016838R  
 Renault 545018194R  
 Renault 545042080R

Nissan 54505-00Q0D  
 Renault 545006560R  
 Renault 545009207R  
 Renault 545009795R  
 Renault 545016101R  
 Renault 545017850R  
 Renault 545019389R  
 Renault 545055050R

**Application info**

Nissan Juke (F16) (08/19--)  
 Renault Fluence (02/10--)  
 Renault Scénic III (12/08--)

Renault Captur II (01/20--)  
 Renault Megane III (11/08--)

**Mount, control arm**

16-14 610 0025

MCB0168

**Notes**

Front Axle Left  
 Front Axle Right  
 Rear  
 inner  
 without holder

Height [mm] 50  
 Inner Diameter [mm] 18  
 Outer Diameter [mm] 55  
 Required quantity 2  
 replacement in pairs recommended



**References**

Renault 545009207R

Renault 545014055R

**Application info**

Renault Fluence (02/10--)

Renault Megane III (11/08--)

Renault Scénic III (12/08--)

**Mount, control arm**

16-14 610 0026

MCB0169

**Notes**

Front  
Front Axle Left  
Front Axle Right  
Rear  
without holder

Height [mm] 45  
Inner Diameter [mm] 14  
Outer Diameter [mm] 37  
Required quantity 4  
replacement in pairs recommended



**References**

Dacia 545006542R

Dacia 545016746R

Dacia 545602788R

Renault 545000138R

Renault 545001535R

Renault 545006542R

Renault 545011697R

Renault 545016746R

Renault 545019969R

Renault 545602788R

**Application info**

Dacia Duster I (04/10--)

Renault Duster I (01/11--)

**Mount, control arm**

16-14 610 0033/HD

MCM0203HD

**Notes**

Carbon Neutral  
Front Axle Left  
Front Axle Right  
Lower  
Rear  
without holder

Height [mm] 65  
Inner Diameter [mm] 14  
Outer Diameter [mm] 70  
Replace in pairs only  
Required quantity 2



**References**

Renault 545000399R  
 Renault 545009795R  
 Renault 545016838R

Renault 545006560R  
 Renault 545016101R  
 Renault 545019389R

**Application info**

Renault Megane III (11/08--)  
 Renault Scénic III (12/08--)

Renault Scenic / Grand Scenic IV (09/16--)

**Mount, control arm**

16-14 610 0034

MCB0555

**Notes**

Front  
 Front Axle Left  
 Front Axle Right  
 Rubber/Metal  
 without holder

Height [mm] 50.5  
 Inner Diameter [mm] 18.6  
 Outer Diameter [mm] 55  
 Required quantity 2  
 replacement in pairs recommended

**References**

Renault 545042021R  
 Renault 545049566R  
 Renault 545058397R

Renault 545045297R  
 Renault 545057449R  
 Renault 545058992R

**Application info**

Renault Megane IV (11/15--)

**Mount, control arm**

16-14 610 0035

MCB0556

**Notes**

Front Axle Left  
 Front Axle Right  
 Rear  
 Rubber/Metal  
 without holder

Height [mm] 75  
 Inner Diameter [mm] 14.1  
 Outer Diameter [mm] 58.1  
 Required quantity 2  
 replacement in pairs recommended



**References**

Renault 545042021R  
 Renault 545049566R  
 Renault 545058397R

Renault 545045297R  
 Renault 545057449R  
 Renault 545058992R

**Application info**

Renault Megane IV (11/15--)

**Mount, control arm**

16-14 610 0036

MCM0206

**Notes**

Front  
 Front Axle Left  
 Front Axle Right  
 Lower  
 Rubber-Metal Mount  
 for control arm  
 without holder

Height [mm] 52.5  
 Inner Diameter [mm] 12.2  
 Outer Diameter [mm] 55  
 Required quantity 2  
 replacement in pairs recommended

**References**

Renault 545047654R  
 Renault 545051097R  
 Smart 453 330 29 00  
 Smart 453 330 31 00  
 Smart A 453 330 29 00  
 Smart A 453 330 31 00

Renault 545048628R  
 Renault 545057345R  
 Smart 453 330 30 00  
 Smart 453 330 32 00  
 Smart A 453 330 30 00  
 Smart A 453 330 32 00

**Application info**

Renault Twingo III (09/14--)  
 Smart Fortwo III (07/14--)

Smart Forfour II (07/14--)



**Mount, control arm**

16-14 610 0037

MCM0207

**Notes**

Front Axle Left  
 Front Axle Right  
 Lower  
 Rear  
 Rubber-Metal Mount  
 for control arm  
 without holder



Height [mm] 76  
 Inner Diameter [mm] 12.2  
 Outer Diameter [mm] 55  
 Required quantity 2  
 replacement in pairs recommended

**References**

Renault 545047654R  
 Renault 545051097R  
 Smart 453 330 29 00  
 Smart 453 330 31 00  
 Smart A 453 330 29 00  
 Smart A 453 330 31 00

Renault 545048628R  
 Renault 545057345R  
 Smart 453 330 30 00  
 Smart 453 330 32 00  
 Smart A 453 330 30 00  
 Smart A 453 330 32 00

**Application info**

Renault Twingo III (09/14--)  
 Smart Fortwo III (07/14--)

Smart Forfour II (07/14--)

**Mount, control arm**

18-14 610 0002

MCB0173

**Notes**

Front Axle Left  
 Front Axle Right  
 Lower  
 without holder



Height [mm] 66  
 Inner Diameter [mm] 14  
 Outer Diameter [mm] 46  
 Required quantity 2  
 replacement in pairs recommended

**References**

Jaguar MNC1360BB  
 Jaguar MNE1360BB

Jaguar MNE1360BA

**Application info**

Jaguar XJ (X300) (09/94-12/99)

Jaguar XK 8 (QDV, QEV) (03/96-12/06)

Jaguar XJ (X308) (09/96-06/03)

**Mount, control arm**

18-14 710 0006

MCB0550

**Notes**Rear Axle Left  
Rear Axle Right  
without holder

Height [mm]

110

Inner Diameter [mm]

14

Outer Diameter [mm]

51

Required quantity

2

replacement in pairs recommended

**References**

Jaguar T2H16771

**Application info**

Jaguar XE (X760) (03/15--)

Jaguar XF II (X260) (05/15--)

**Mount, control arm**

18-14 710 0009/HD

MCB0493HD

**Notes**Carbon Neutral  
Front  
Rear Axle Left  
Rear Axle Right  
without holder

Height [mm]

71

Inner Diameter [mm]

14

Outer Diameter [mm]

56

Replace in pairs only

Required quantity

2

reinforced version

**References**

Jaguar C2P14467

Jaguar C2P16878

Jaguar C2P3710

Jaguar C2P14468

Jaguar C2P16879

Jaguar XR849497

**Application info**

Jaguar S-Type (CCX) (10/98-12/08)

Jaguar XK (03/06-12/14)

**Mount, control arm** **18-16 710 0002** **MCB0562**

**Notes**

Lower  
Molecular Bearing  
Rear Axle Left  
Rear Axle Right  
outer  
without holder

Height [mm] 54  
Inner Diameter [mm] 14.2  
Outer Diameter [mm] 47  
Required quantity 2  
replacement in pairs recommended



**References**

Jaguar C2P14467	Jaguar C2P14468
Jaguar C2P16878	Jaguar C2P16879
Jaguar C2P3710	Jaguar XR849497

**Application info**

Jaguar S-Type (CCX) (10/98-12/08)	Jaguar XK (03/06-12/14)
-----------------------------------	-------------------------

**Mount, control arm** **214 610 0000** **MCM0042**

**Notes**

Front  
Front Axle Left  
Front Axle Right  
Lower  
Rubber-Metal Mount  
with holder

Height [mm] 50  
Inner Diameter [mm] 23  
Required quantity 2  
replacement in pairs recommended



**References**

Citroën 13 123 170 80

Citroën 3520.C3

Citroën 3520.G9

Citroën 3520.P6

Citroën 3521.64

Citroën 3521.85

Citroën 3521.H0

Citroën 3521.K4

Citroën 3521.L0

Fiat 1313083080

Fiat 1316735080

Fiat 1317389080

Fiat 1322663080

Fiat 1333754080

Fiat 134 638 5080

Fiat 71737047

Fiat 93500972

Fiat 93501487

Lancia 1313083080

Lancia 1316735080

Lancia 1317389080

Lancia 1322663080

Lancia 1333754080

Lancia 1346385080

Lancia 71737048

Lancia 93501488

Peugeot 3520.C3

Peugeot 3520.C9

Peugeot 3520.P4

Peugeot 3520.P8

Peugeot 3521.83

Peugeot 3521.C9

Peugeot 3521.H1

Peugeot 3521.K6

Citroën 3520.94

Citroën 3520.C5

Citroën 3520.P4

Citroën 3520.P8

Citroën 3521.83

Citroën 3521.C9

Citroën 3521.H1

Citroën 3521.K6

Fiat 1312317080

Fiat 1313084080

Fiat 1316736080

Fiat 1317390080

Fiat 1322664080

Fiat 1333755080

Fiat 1346384080

Fiat 71737048

Fiat 93500973

Fiat 93501488

Lancia 1313084080

Lancia 1316736080

Lancia 1317390080

Lancia 1322664080

Lancia 1333755080

Lancia 71737047

Lancia 93501487

Peugeot 3520.94

Peugeot 3520.C5

Peugeot 3520.G9

Peugeot 3520.P6

Peugeot 3521.64

Peugeot 3521.85

Peugeot 3521.H0

Peugeot 3521.K4

Peugeot 3521.L0

**Application info**

Citroën C8 (06/02--)

Citroën Jumpy I (06/94-12/06)

Fiat Ulysse I (220) (06/94-08/02)

Lancia Phedra (09/02-11/10)

Peugeot 806 (06/94-02/03)

Peugeot Expert I (07/95-03/08)

Citroën Evasion (03/94-10/02)

Fiat Scudo I (220) (02/96-12/06)

Fiat Ulysse II (179) (08/02-06/11)

Lancia Zeta (05/95-10/03)

Peugeot 807 (06/02--)

**Mount, control arm**

214 610 0001

MCB0175

**Notes**

Front  
 Front Axle Left  
 Front Axle Right  
 Lower  
 without holder

Height [mm] 55  
 Inner Diameter [mm] 12  
 Outer Diameter [mm] 30  
 Required quantity 2  
 replacement in pairs recommended

**References**

Fiat 46421522

**Application info**

Fiat Doblo (119, 223) (11/00--)

Fiat Palio / Albea / Siena / Strada (04/96--)

**Mount, control arm**

214 610 0002

MCM0043

**Notes**

Front  
 Front Axle Left  
 Front Axle Right  
 Lower  
 with holder

Height [mm] 50  
 Inner Diameter [mm] 21  
 Outer Diameter [mm] 41  
 Required quantity 2  
 replacement in pairs recommended



**References**

Alfa Romeo 46423824  
 Alfa Romeo 46474556  
 Alfa Romeo 60586771  
 Alfa Romeo 60809813  
 Alfa Romeo 60813013  
 Alfa Romeo 60813043  
 Alfa Romeo 93501116  
 Fiat 46423822  
 Fiat 46456049  
 Fiat 46462626  
 Fiat 46474556  
 Fiat 60811769  
 Fiat 71747915  
 Fiat 7601064  
 Fiat 7777240  
 Fiat 7780444  
 Fiat 82461082  
 Fiat 93501117  
 Lancia 46423823  
 Lancia 46474557  
 Lancia 71747916  
 Lancia 7601062  
 Lancia 7777240  
 Lancia 82461082

Alfa Romeo 46423825  
 Alfa Romeo 46474557  
 Alfa Romeo 60586772  
 Alfa Romeo 60809814  
 Alfa Romeo 60813014  
 Alfa Romeo 60813044  
 Alfa Romeo 93501117  
 Fiat 46423823  
 Fiat 46456050  
 Fiat 46462627  
 Fiat 46474557  
 Fiat 60811770  
 Fiat 71747916  
 Fiat 7777239  
 Fiat 7780443  
 Fiat 82461081  
 Fiat 93501116  
 Lancia 46423822  
 Lancia 46474556  
 Lancia 71747915  
 Lancia 7601057  
 Lancia 7777239  
 Lancia 82461081

**Application info**

Alfa Romeo 145 / 146 (07/94-10/01)  
 Alfa Romeo GTV (09/94-10/05)  
 Fiat Brava / Bravo (182) (10/95-06/03)  
 Fiat Marea / Multipla (05/96-06/10)  
 Lancia Dedra (01/89-07/99)  
 Lancia Kappa (08/94-10/01)

Alfa Romeo 155 (01/92-12/97)  
 Alfa Romeo Spider (916) (09/94-04/05)  
 Fiat Coupé (11/93-08/00)  
 Fiat Tempra / Tipo (07/87-12/98)  
 Lancia Delta I / II (09/79-09/99)

## Mount, control arm

214 610 0003

MCM0044

## Notes

Front Axle Right  
 Lower  
 Rear  
 with holder

Height [mm] 52  
 Inner Diameter [mm] 21  
 Outer Diameter [mm] 59  
 Paired article number 214 610 0008 | MCM0046  
 Required quantity 1  
 replacement in pairs recommended



## References

Alfa Romeo 46423825	Alfa Romeo 46474557
Alfa Romeo 60586772	Alfa Romeo 60809814
Alfa Romeo 60813014	Alfa Romeo 60813044
Alfa Romeo 93501117	Fiat 46423823
Fiat 46456050	Fiat 46462627
Fiat 46474557	Fiat 60811770
Fiat 71747916	Fiat 7601068
Fiat 7777240	Fiat 7780444
Fiat 82461082	Fiat 93501117
Lancia 46423823	Lancia 46474557
Lancia 71747916	Lancia 7601062
Lancia 7777240	Lancia 82461082

## Application info

Alfa Romeo 145 / 146 (07/94-10/01)	Alfa Romeo 155 (01/92-12/97)
Alfa Romeo GTV (09/94-10/05)	Alfa Romeo Spider (916) (09/94-04/05)
Fiat Brava / Bravo (182) (10/95-06/03)	Fiat Coupé (11/93-08/00)
Fiat Marea / Multipla (05/96-06/10)	Fiat Tempra / Tipo (07/87-12/98)
Lancia Dedra (01/89-07/99)	Lancia Delta I / II (09/79-09/99)
Lancia Kappa (08/94-10/01)	

## Mount, control arm

214 610 0008

MCM0046

## Notes

Front Axle Left  
 Lower  
 Rear  
 with holder

Height [mm] 52  
 Inner Diameter [mm] 21  
 Outer Diameter [mm] 59  
 Paired article number 214 610 0003 | MCM0044  
 Required quantity 1  
 replacement in pairs recommended



## References

Alfa Romeo 46423824	Alfa Romeo 46474556
Alfa Romeo 60586771	Alfa Romeo 60809813
Alfa Romeo 60813013	Alfa Romeo 60813043
Alfa Romeo 93501116	Fiat 46423822
Fiat 46456049	Fiat 46462626
Fiat 46474556	Fiat 60811769
Fiat 71747915	Fiat 7601065
Fiat 7777239	Fiat 7780443
Fiat 82461081	Fiat 93501116
Lancia 46423822	Lancia 46474556
Lancia 71747915	Lancia 7601057
Lancia 7777239	Lancia 82461081

## Application info

Alfa Romeo 145 / 146 (07/94-10/01)	Alfa Romeo 155 (01/92-12/97)
Alfa Romeo GTV (09/94-10/05)	Alfa Romeo Spider (916) (09/94-04/05)
Fiat Brava / Bravo (182) (10/95-06/03)	Fiat Coupé (11/93-08/00)
Fiat Marea / Multipla (05/96-06/10)	Fiat Tempra / Tipo (07/87-12/98)
Lancia Dedra (01/89-07/99)	Lancia Delta I / II (09/79-09/99)
Lancia Kappa (08/94-10/01)	



**Mount, control arm****214 610 0013****MCM0049****Notes**

Front Axle Left  
 Lower  
 Rear  
 with holder  
 Paired article number 214 610 0014 | MCM0050  
 Required quantity 1  
 replacement in pairs recommended

**References**

Citroën 3520.94	Citroën 3520.C3
Citroën 3520.C5	Citroën 3520.G9
Citroën 3520.P4	Citroën 3520.P8
Fiat 1305551080	Fiat 1313083080
Fiat 1316735080	Fiat 1317389080
Fiat 1322663080	Fiat 1333754080
Fiat 71737047	Fiat 93500972
Lancia 1313083080	Lancia 1316735080
Lancia 1317389080	Lancia 1322663080
Lancia 1333754080	Lancia 71737047
Peugeot 3520.94	Peugeot 3520.C3
Peugeot 3520.C5	Peugeot 3520.C9
Peugeot 3520.G9	Peugeot 3520.P4
Peugeot 3520.P8	

**Application info**

Citroën Evasion (03/94-10/02)	Citroën Jumpy I (06/94-12/06)
Fiat Scudo I (220) (02/96-12/06)	Fiat Ulysse I (220) (06/94-08/02)
Lancia Zeta (05/95-10/03)	Peugeot 806 (06/94-02/03)
Peugeot Expert I (07/95-03/08)	

## Mount, control arm

214 610 0014

MCM0050

## Notes

Front Axle Right  
 Lower  
 Rear  
 with holder  
 Paired article number 214 610 0013 | MCM0049  
 Required quantity 1  
 replacement in pairs recommended



## References

Citroën 3521.64	Citroën 3521.83
Citroën 3521.85	Citroën 3521.C9
Citroën 3521.K4	Citroën 3521.L0
Fiat 1305552080	Fiat 1313084080
Fiat 1316736080	Fiat 1317390080
Fiat 1322664080	Fiat 1333755080
Fiat 71737048	Fiat 93500973
Lancia 1313084080	Lancia 1316736080
Lancia 1317390080	Lancia 1322664080
Lancia 1333755080	Lancia 71737048
Peugeot 3521.64	Peugeot 3521.83
Peugeot 3521.85	Peugeot 3521.C9
Peugeot 3521.K4	Peugeot 3521.L0

## Application info

Citroën Evasion (03/94-10/02)	Citroën Jumpy I (06/94-12/06)
Fiat Scudo I (220) (02/96-12/06)	Fiat Ulysse I (220) (06/94-08/02)
Lancia Zeta (05/95-10/03)	Peugeot 806 (06/94-02/03)
Peugeot Expert I (07/95-03/08)	

## Mount, control arm

214 610 0019

MCB0177

## Notes

Front  
 Front Axle Left  
 Front Axle Right  
 inner  
 without holder

Height [mm] 52.5  
 Inner Diameter [mm] 12  
 Outer Diameter [mm] 33.5  
 Required quantity 2  
 replacement in pairs recommended



## References

ABARTH 50710620	ABARTH 50710621
ABARTH 51857022	ABARTH 52045068
Fiat 2146100015	Fiat 46545660
Fiat 46545661	Fiat 50703128
Fiat 50703231	Fiat 50703232
Fiat 50709580	Fiat 50710620
Fiat 51839218	Fiat 51839219
Fiat 51842192	Fiat 51842193
Fiat 51857022	Fiat 51857133
Fiat 52045068	Ford 1 540 244
Ford 1 540 246	Ford 1 548 515
Ford 1 580 514	Ford 1 580 515
Ford 1 639 574	Ford 1 639 575
Ford 6M2J-U23942-CA	Ford 9S51-3078-AA
Ford 9S51-3078-AB	Ford 9S51-3078-AC
Ford 9S51-3078-BA	Ford 9S51-3078-BB
Ford 9S51-3078-BC	Lancia 50703231
Lancia 50703232	Lancia 51839218
Lancia 51839219	

## Application info

ABARTH 500 (01/08--)	Fiat 500 (07/07--)
Fiat Idea (12/03--)	Fiat Panda II (09/03--)
Fiat Punto II (09/99-07/12)	Ford KA II (10/08-05/16)
Lancia Musa (10/04-09/12)	Lancia Ypsilon (843) (10/03-12/11)

**Mount, control arm**

214 610 0020

MCB0178

**Notes**

Front Axle Left  
 Front Axle Right  
 Rear  
 inner  
 without holder

Height [mm] 51.9  
 Inner Diameter [mm] 14.5  
 Outer Diameter [mm] 60.7  
 Required quantity 2  
 replacement in pairs recommended

**References**

Fiat 50703128

Fiat 51857133

**Application info**

Fiat Panda II (09/03--)

**Mount, control arm**

214 610 0021

MCB0179

**Notes**

Front Axle Left  
 Front Axle Right  
 Rear  
 without holder

Height [mm] 52  
 Inner Diameter [mm] 14  
 Outer Diameter [mm] 61  
 Required quantity 2  
 replacement in pairs recommended

**References**

ABARTH 50710620

ABARTH 51857021

ABARTH 51857022

ABARTH 51860383

ABARTH 52045068

ABARTH 52045069

Fiat 50709579

Fiat 50709580

Fiat 50710620

Fiat 50710621

Fiat 51857021

Fiat 51857022

Fiat 51860383

Fiat 51896150

Fiat 52045068

Fiat 52045069

Ford 1 540 244

Ford 1 540 246

Ford 1 548 515

Ford 1 580 514

Ford 1 639 574

Ford 1 639 575

**Application info**

ABARTH 500 (01/08--)  
Ford KA II (10/08-05/16)

Fiat 500 (07/07--)

**Mount, control arm**

214 610 0022

MCM0051

**Notes**

Front Axle Left  
Lower  
Rear  
with holder

Height [mm] 52  
Inner Diameter [mm] 16  
Paired article number 214 610 0023 | MCM0052  
Required quantity 1  
replacement in pairs recommended



**References**

Fiat 46454598	Fiat 46539279
Fiat 46748578	Fiat 46777741
Fiat 46794065	Fiat 46813841
Fiat 51712407	Fiat 51747323
Fiat 51764470	Fiat 51769073
Fiat 51866700	

**Application info**

Fiat Doblo (119, 223) (11/00--)

Fiat Palio / Albea / Siena / Strada (04/96--)

**Mount, control arm**

214 610 0023

MCM0052

**Notes**

Front Axle Right  
Lower  
Rear  
with holder

Height [mm] 52  
Inner Diameter [mm] 16  
Paired article number 214 610 0022 | MCM0051  
Required quantity 1  
replacement in pairs recommended



**References**

Fiat 46454597  
 Fiat 46551377  
 Fiat 46777742  
 Fiat 46813842  
 Fiat 51764471  
 Fiat 51866701

Fiat 46539278  
 Fiat 46748579  
 Fiat 46794066  
 Fiat 51712408  
 Fiat 51769074

**Application info**

Fiat Doblo (119, 223) (11/00--)

Fiat Palio / Albea / Siena / Strada (04/96--)

**Mount, control arm**

214 610 0024

MCB0180

**Notes**

Front Axle Left  
 Front Axle Right  
 Rear  
 without holder

Height [mm] 52  
 Inner Diameter [mm] 14  
 Outer Diameter [mm] 61  
 Required quantity 2  
 replacement in pairs recommended



**References**

Fiat 46545660  
 Fiat 51842192

Fiat 46545661  
 Fiat 51842193

**Application info**

Fiat Punto II (09/99-07/12)

**Mount, control arm**

214 610 0029

MCB0181

**Notes**

Front Axle Left  
 Front Axle Right  
 Rear  
 without holder

Height [mm] 72  
 Inner Diameter [mm] 12  
 Outer Diameter [mm] 71.5  
 Required quantity 2  
 replacement in pairs recommended



**References**

Fiat 51810664  
 Fiat 51885660  
 Fiat 51932035  
 Fiat 52008282  
 Fiat 52026316  
 Opel 3 52 537  
 Vauxhall 95514536

Fiat 51810665  
 Fiat 51885737  
 Fiat 51932036  
 Fiat 52008283  
 Fiat 52026317  
 Opel 3 52 538  
 Vauxhall 95514537

**Application info**

Fiat 500L (09/12--)  
 Opel Combo D (02/12--)

Fiat Doblo (263) (11/09--)  
 Vauxhall Combo Mk III (07/06--)

**Mount, control arm****214 610 0042****MCB0398****Notes**

Front  
 Front Axle Left  
 Front Axle Right  
 Lower  
 without holder

Height [mm] 60  
 Inner Diameter [mm] 14.4  
 Outer Diameter [mm] 34.8  
 Required quantity 2  
 replacement in pairs recommended

**References**

Chrysler 04766423AD  
 Chrysler 04766423AF  
 Chrysler 04766424AE  
 Dodge K04766423AB  
 Fiat K04766423AA  
 Fiat K04766423AC  
 Fiat K04766423AE  
 Fiat K04766424AB  
 Fiat K04766424AD

Chrysler 04766423AE  
 Chrysler 04766424AD  
 Chrysler 04766424AF  
 Dodge K04766424AC  
 Fiat K04766423AB  
 Fiat K04766423AD  
 Fiat K04766424AA  
 Fiat K04766424AC  
 Fiat K04766424AE

**Application info**

Dodge Journey (06/08--)

Fiat Freemont (JC) (08/11--)

**Mount, control arm****214 610 0043****MCB0434****Notes**

Front Axle Left  
 Front Axle Right  
 Lower  
 Rear  
 without holder

Height [mm] 66.3  
 Inner Diameter [mm] 14.4  
 Outer Diameter [mm] 77  
 Required quantity 2  
 replacement in pairs recommended

**References**

Chrysler 04766423AD  
 Chrysler 04766423AF  
 Chrysler 04766424AE  
 Dodge K04766423AB  
 Fiat K04766423AA  
 Fiat K04766423AC  
 Fiat K04766423AE  
 Fiat K04766424AB  
 Fiat K04766424AD

Chrysler 04766423AE  
 Chrysler 04766424AD  
 Chrysler 04766424AF  
 Dodge K04766424AC  
 Fiat K04766423AB  
 Fiat K04766423AD  
 Fiat K04766424AA  
 Fiat K04766424AC  
 Fiat K04766424AE

**Application info**

Dodge Journey (06/08--)

Fiat Freemont (JC) (08/11--)

**Mount, control arm****214 610 0046****MCB0475****Notes**

Front  
 Front Axle Left  
 Front Axle Right  
 without holder

Height [mm] 67.5  
 Inner Diameter [mm] 14.5  
 Outer Diameter [mm] 43.5  
 Required quantity 2  
 replacement in pairs recommended





**References**

Fiat 50704262	Fiat 50705464
Fiat 50705465	Fiat 50705544
Fiat 51739755	Fiat 51795260
Fiat 51827736	Fiat 51827737
Fiat 51827738	Fiat 51939751
Fiat 51939753	Fiat 51959820
Fiat 51961341	Fiat 51983599
Fiat 52011612	Fiat 52011614
Jeep 51959820	Jeep 51961341
Lancia 50705464	Lancia 50705465
Lancia 50705544	Lancia 51795260
Lancia 51827736	Lancia 51827737
Lancia 51827738	

**Application info**

Fiat 500X (09/14--)	Fiat Bravo (198) (11/06--)
Fiat Stilo (10/01-11/10)	Fiat Tipo (356) (10/15--)
Jeep Renegade (BU, B1) (07/14--)	Lancia Delta III (08/08-08/14)

**Mount, control arm**

214 610 0047

MCB0476

**Notes**

Front Axle Left  
 Front Axle Right  
 Rear  
 without holder

Height [mm]	66
Inner Diameter [mm]	14
Outer Diameter [mm]	70
Required quantity	2
replacement in pairs recommended	









**References**

Fiat 51983600	Fiat 52011612
Fiat 52011614	Fiat 52082552
Fiat 52082897	

**Application info**

Fiat Tipo (356) (10/15--)

Mount, control arm		214 610 0048	MCB0480
<b>Notes</b>  Front Axle Left Front Axle Right Rear without holder  Height [mm] 66 Inner Diameter [mm] 14 Outer Diameter [mm] 70 Required quantity 2 replacement in pairs recommended		 	
<b>References</b> Fiat 51939751 Fiat 51939754 Fiat 51939755 Fiat 51959820 Fiat 51961341 Jeep 51959820 Jeep 51961341			
<b>Application info</b> Fiat 500X (09/14--) Jeep Renegade (BU, B1) (07/14--) 			
Mount, control arm		216 610 0000	MCB0185
<b>Notes</b>  Front Axle Left Front Axle Right Lower Rear without holder  Height [mm] 65 Inner Diameter [mm] 12 Outer Diameter [mm] 60 Required quantity 2 replacement in pairs recommended		 	
<b>References</b> Fiat 50700778 Lancia 50700778			
<b>Application info</b> Fiat Bravo (198) (11/06--) Lancia Delta III (08/08-08/14) Fiat Stilo (10/01-11/10)			

Mount, control arm		216 610 0001	MCB0186
<b>Notes</b>  Front Front Axle Left Front Axle Right Lower without holder  Height [mm] 68 Inner Diameter [mm] 12 Outer Diameter [mm] 42 Required quantity 2 replacement in pairs recommended			
<b>References</b> Fiat 50700443			
<b>Application info</b> Fiat Stilo (10/01-11/10)			
Mount, control arm		28-14 610 0001	MCM0056
<b>Notes</b>  Centre Front Axle Left Front Axle Right without holder  Height [mm] 27 Outer Diameter [mm] 54 Required quantity 2 replacement in pairs recommended			
<b>References</b> Kia 54590 3E000			
<b>Application info</b> Kia Sorento I (08/02--)			

**Mount, control arm****28-14 610 0002****MCB0189****Notes**

Front Axle Left  
 Front Axle Right  
 Lower  
 inner  
 without holder

Height [mm]

69

Inner Diameter [mm]

18

Outer Diameter [mm]

54.5

Required quantity

2

replacement in pairs recommended

**References**

Kia 54580 3E002

**Application info**

Kia Sorento I (08/02--)

**Mount, control arm****29-14 610 0000****MCB0190****Notes**

Front Axle Left  
 Front Axle Right  
 Lower  
 Rear  
 without holder

Height [mm]

54

Inner Diameter [mm]

12

Outer Diameter [mm]

60

Required quantity

2

replacement in pairs recommended

**References**

Chevrolet 96391856

Daewoo 96391856

**Application info**

Chevrolet Lacetti (03/03--)

Chevrolet Nubira (01/05-12/11)

Daewoo Lacetti (02/02--)

Daewoo Nubira (KLAN) (07/03--)

**Mount, control arm**

29-14 610 0002

MCB0192

**Notes**

Front Axle Left  
 Front Axle Right  
 Lower  
 Rear  
 without holder

Height [mm] 54  
 Inner Diameter [mm] 12  
 Outer Diameter [mm] 72  
 Required quantity 2  
 replacement in pairs recommended

**References**

Chevrolet 96261107  
 Daewoo 96261107

Chevrolet 96431044  
 Daewoo 96431044

**Application info**

Chevrolet Lacetti (03/03--)  
 Chevrolet Rezzo (03/05--)

Chevrolet Nubira (01/05-12/11)

**Mount, control arm**

29-14 610 0003

MCB0193

**Notes**

Front Axle Left  
 Front Axle Right  
 Lower  
 Rear  
 without holder

Height [mm] 46  
 Inner Diameter [mm] 12  
 Outer Diameter [mm] 60  
 Required quantity 2  
 replacement in pairs recommended

**References**

Chevrolet 95479763  
 Chevrolet 96653381  
 Daewoo 96653381

Chevrolet 96535088  
 Daewoo 96535088

**Application info**

Chevrolet Astro I (02/03-05/08)  
 Daewoo Kalos (09/02--)

Chevrolet Aveo I (01/03--)

**Mount, control arm** **300 311 2104/HD** **MCB0205HD**

**Notes**

Carbon Neutral  
 Front  
 Front Axle Left  
 Front Axle Right  
 without holder

Height [mm] 63  
 Inner Diameter [mm] 14  
 Outer Diameter [mm] 66  
 Replace in pairs only  
 Required quantity 2  
 reinforced version



**References**

BMW 0 307 882 BMW 1 096 372  
 BMW 3 412 781 BMW 31 10 3 412 781  
 BMW 31 12 0 307 882 BMW 31 12 1 096 372  
 BMW 31 12 6 769 715 BMW 6 769 715

**Application info**

BMW X3 (E83) (01/03-12/11) BMW X5 (E53) (01/00-12/06)

**Mount, control arm** **300 311 2107** **MCB0206**

**Notes**

Front Axle Left  
 Front Axle Right  
 Rear  
 without holder

Height [mm] 52  
 Inner Diameter [mm] 12  
 Outer Diameter [mm] 47  
 Required quantity 2  
 replacement in pairs recommended



**References**

BMW 1 094 235	BMW 1 124 622
BMW 1 133 236	BMW 1 139 826
BMW 31 12 1 094 235	BMW 31 12 1 124 622
BMW 31 12 1 133 236	BMW 31 12 1 139 826
BMW 31 12 6 852 991	BMW 31 12 6 852 992
BMW 31 12 6 854 727	BMW 31 12 6 854 728
BMW 6 852 991	BMW 6 852 992
BMW 6 854 727	BMW 6 854 728
BMW (Brilliance) 1 094 235	BMW (Brilliance) 1 124 622
BMW (Brilliance) 1 133 236	BMW (Brilliance) 1 139 826
BMW (Brilliance) 31 12 1 094 235	BMW (Brilliance) 31 12 1 124 622
BMW (Brilliance) 31 12 1 133 236	BMW (Brilliance) 31 12 1 139 826
BMW (Brilliance) 31 12 6 852 991	BMW (Brilliance) 6 852 991

**Application info**

BMW 1 (F20, F21) (07/11--)	BMW 2 (F22,F23) (10/12--)
BMW 3 (F30, F31) (11/11-06/19)	BMW 3 (F34) (07/12--)
BMW 4 (F32, F33, F36) (07/13--)	BMW 5 (E28) (05/81-12/87)
BMW 5 (E34) (02/87-07/96)	BMW 5 (E39) (09/95-06/04)
BMW 5 (E60, E61) (12/01-12/10)	BMW 6 (E24) (10/75-04/89)
BMW 6 (E63, E64) (09/03-12/10)	BMW 7 (E32) (03/85-10/94)
BMW 7 (E38) (03/94-11/01)	BMW 7 (E65, E66) (07/01-12/09)
BMW 8 (E31) (01/90-12/99)	BMW X3 (E83) (01/03-12/11)
BMW X5 (E53) (01/00-12/06)	

**Mount, control arm**

300 311 2919/HD

MCM0066HD

**Notes**

Carbon Neutral  
 Front Axle Left  
 Front Axle Right  
 Set  
 with accessories  
 without holder

Height [mm]	60
Inner Diameter [mm]	20
Outer Diameter [mm]	66
Replace in pairs only	
Required quantity	2
reinforced version	



**References**

BMW 31 12 6 757 623

BMW 31 12 6 783 376

BMW 6 777 850

BMW (Brilliance) 31 12 6 757 623

BMW (Brilliance) 31 12 6 783 376

BMW (Brilliance) 6 777 850

BMW 31 12 6 777 850

BMW 6 757 623

BMW 6 783 376

BMW (Brilliance) 31 12 6 777 850

BMW (Brilliance) 6 757 623

BMW (Brilliance) 6 783 376

**Application info**

BMW 3 (E46) (12/97-12/07)

BMW Z4 (E86) (03/06-01/09)

BMW Z4 (E85) (09/02-12/09)

**Mount, control arm**

30-14 610 0010

MCB0197

**Notes**

Front Axle Left  
 Front Axle Right  
 Lower  
 Rear  
 without holder

Height [mm]

58

Inner Diameter [mm]

12

Outer Diameter [mm]

55

Required quantity

2

replacement in pairs recommended



**References**

Toyota 48068-59035

Toyota 48069-59035

Toyota 48068-59055

Toyota 48069-59055

**Application info**

Toyota Yaris I (01/99-12/05)



**Mount, control arm****30-14 610 0011****MCB0198****Notes**

Front  
 Front Axle Left  
 Front Axle Right  
 Lower  
 without holder

Height [mm] 53  
 Inner Diameter [mm] 12  
 Outer Diameter [mm] 33  
 Required quantity 2  
 replacement in pairs recommended

**References**

Toyota 48068-59035  
 Toyota 48069-59035

Toyota 48068-59055  
 Toyota 48069-59055

**Application info**

Toyota Yaris I (01/99-12/05)

**Mount, control arm****30-14 610 0014****MCB0469****Notes**

Front  
 Front Axle Left  
 Front Axle Right  
 Lower  
 without holder

Height [mm] 65  
 Inner Diameter [mm] 16  
 Outer Diameter [mm] 42  
 Required quantity 2  
 replacement in pairs recommended

**References**

Lexus 48068-47050  
 Toyota 48068-47050  
 Toyota 48069-0R010  
 Toyota 48069-47060

Toyota 48068-42050  
 Toyota 48068-47060  
 Toyota 48069-42050

**Application info**

Lexus CT (ZWA1) (12/10--)  
 Toyota Prius III (06/08--)  
 Toyota RAV 4 III (06/05-08/14)

Toyota Corolla (\_E21\_) (10/18--)  
 Toyota Prius IV (09/15--)

**Mount, control arm**

30-14 610 0016

MCB0200

**Notes**

Front  
 Front Axle Left  
 Front Axle Right  
 Lower  
 without holder

Height [mm] 53  
 Inner Diameter [mm] 14  
 Outer Diameter [mm] 35  
 Required quantity 2  
 replacement in pairs recommended



**References**

- |                      |                      |
|----------------------|----------------------|
| Daihatsu 48068-09041 | Daihatsu 48069-09041 |
| Subaru 4806859145    | Subaru 4806959135    |
| Toyota 48068-09040   | Toyota 48068-09041   |
| Toyota 48068-09150   | Toyota 48068-59095   |
| Toyota 48068-59135   | Toyota 48068-59145   |
| Toyota 48069-09040   | Toyota 48069-09041   |
| Toyota 48069-09140   | Toyota 48069-59095   |
| Toyota 48069-59125   | Toyota 48069-59135   |
| Toyota 48069-59145   |                      |

**Application info**

- |   |  |
|---|--|
| Daihatsu Charade V (05/11--)                | Subaru Trezia (11/10--)                    |
| Toyota Prius C (NHP10) (09/11--)            | Toyota Urban Cruiser (NCP11) (07/07-03/16) |
| Toyota Verso S (NCP12, NSP12) (11/10-10/16) | Toyota Yaris II (01/05-12/14)              |
| Toyota Yaris III (12/10--)                  |  |

**Mount, control arm**

30-14 610 0021

MCB0202

**Notes**

Front  
 Front Axle Left  
 Front Axle Right  
 Lower  
 without holder

Height [mm] 71  
 Inner Diameter [mm] 19  
 Outer Diameter [mm] 48  
 Required quantity 2  
 replacement in pairs recommended



**References**

Lexus 48654-60030

Toyota 48654-60030

**Application info**

Toyota Land Cruiser (J12) (09/02-12/10)

**Mount, control arm**

30-14 610 0024

MCB0464

**Notes**

Front Axle Left  
 Front Axle Right  
 Lower  
 Rear  
 without holder

Height [mm] 60  
 Inner Diameter [mm] 16  
 Outer Diameter [mm] 68  
 Required quantity 2  
 replacement in pairs recommended



**References**

Toyota 48068-42050

Toyota 48069-42050

**Application info**

Toyota RAV 4 III (06/05-08/14)

**Mount, control arm**

30-14 610 0041

MCB0557

**Notes**

Front  
 Front Axle Left  
 Front Axle Right  
 Lower  
 without holder

Height [mm] 52.9  
 Inner Diameter [mm] 12.1  
 Outer Diameter [mm] 34.5  
 Required quantity 2  
 replacement in pairs recommended



**References**

Citroën 16 073 046 80	Citroën 16 073 047 80
Citroën 16 141 914 80	Citroën 16 141 916 80
Citroën 3520.Q2	Citroën 3521.L3
Citroën B0 007 701 80	Citroën B0 007 702 80
Peugeot 16 07 304 680	Peugeot 16 07 304 780
Peugeot 16 14 191 480	Peugeot 16 14 191 680
Peugeot 3520.Q2	Peugeot 3521.L3
Peugeot B0 00 770 180	Peugeot B0 00 770 280
Toyota 48068-0H010	Toyota 48068-0H020
Toyota 48068-0H021	Toyota 48069-0H010
Toyota 48069-0H020	Toyota 48069-0H021

**Application info**

Citroën C1 (06/05-09/14)	Citroën C1 II (04/14--)
Peugeot 107 (06/05-05/14)	Peugeot 108 (05/14--)
Toyota Aygo I (02/05-05/14)	Toyota Aygo II (05/14--)

**Mount, control arm****30-14 610 0042****MCB0558****Notes**

Front Axle Left  
 Front Axle Right  
 Lower  
 Rear  
 without holder

Height [mm]	62.2
Inner Diameter [mm]	12.1
Outer Diameter [mm]	57.4
Required quantity	2
replacement in pairs recommended	

**References**

Citroën 16 073 046 80	Citroën 16 073 047 80
Citroën 16 141 914 80	Citroën 16 141 916 80
Citroën 3520.Q2	Citroën 3521.L3
Citroën B0 007 701 80	Citroën B0 007 702 80
Peugeot 16 07 304 680	Peugeot 16 07 304 780
Peugeot 16 14 191 480	Peugeot 16 14 191 680
Peugeot 3520.Q2	Peugeot 3521.L3
Peugeot B0 00 770 180	Peugeot B0 00 770 280
Toyota 48068-0H010	Toyota 48068-0H020
Toyota 48068-0H021	Toyota 48069-0H010
Toyota 48069-0H020	Toyota 48069-0H021

**Application info**

Citroën C1 (06/05-09/14)  
 Peugeot 107 (06/05-05/14)  
 Toyota Aygo I (02/05-05/14)

Citroën C1 II (04/14--)  
 Peugeot 108 (05/14--)  
 Toyota Aygo II (05/14--)

**Mount, control arm****31-14 610 0000****MCB0479****Notes**

Front Axle Left  
 Front Axle Right  
 Lower  
 Rear  
 without holder

Height [mm] 63  
 Inner Diameter [mm] 14  
 Outer Diameter [mm] 42  
 Required quantity 2  
 replacement in pairs recommended

**References**

Honda 51392-S5A-004

Honda 51392-S5A-701

**Application info**

Honda CR-V II (09/01-07/07)  
 Honda FR-V (08/04--)

Honda Civic VII (03/99-04/06)  
 Honda Stream (05/01--)

**Mount, control arm****31-14 610 0001****MCB0407****Notes**

Front  
 Front Axle Left  
 Front Axle Right  
 Lower  
 without holder

Height [mm] 63  
 Inner Diameter [mm] 14  
 Outer Diameter [mm] 43  
 Required quantity 2  
 replacement in pairs recommended

**References**

Honda 51391-S5A-004  
 Honda 51391-S7A-005

Honda 51391-S5A-024

**Application info**

Honda CR-V II (09/01-07/07)  
Honda FR-V (08/04--)

Honda Civic VII (03/99-04/06)  
Honda Stream (05/01--)

**Mount, control arm**

31-14 610 0010/HD

MCM0069HD

**Notes**

Carbon Neutral  
Front Axle Right  
Lower  
Rear  
with holder

Height [mm] 58  
Inner Diameter [mm] 25  
Paired article number 31-14 610 0011/HD | MCM0070HD  
Replace in pairs only  
Required quantity 1  
reinforced version



**References**

Honda 51395-SMG-E02  
Honda 51395-SMG-E04

Honda 51395-SMG-E03  
Honda 51395-SMG-E05

**Application info**

Honda Civic VIII (09/05--)

**Mount, control arm**

31-14 610 0011/HD

MCM0070HD

**Notes**

Carbon Neutral  
Front Axle Left  
Lower  
Rear  
with holder

Height [mm] 58  
Inner Diameter [mm] 25  
Paired article number 31-14 610 0010/HD | MCM0069HD  
Replace in pairs only  
Required quantity 1  
reinforced version



**References**

Honda 51396-SMG-E02  
Honda 51396-SMG-E04

Honda 51396-SMG-E03  
Honda 51396-SMG-E05

**Application info**

Honda Civic VIII (09/05--)

**Mount, control arm**

314 610 0002/HD

MCM0072HD

**Notes**Carbon Neutral  
Front Axle Left  
with holder

Inner Diameter [mm]

20

Paired article number

314 610 0003/HD | MCM0073HD

Replace in pairs only

Required quantity

1

reinforced version

**References**

Mini 31 12 6 757 561

Mini 6 757 561

**Application info**

Mini Mini I (06/01-07/08)

**Mount, control arm**

314 610 0003/HD

MCM0073HD

**Notes**Carbon Neutral  
Front Axle Right  
with holder

Inner Diameter [mm]

20

Paired article number

314 610 0002/HD | MCM0072HD

Replace in pairs only

Required quantity

1

reinforced version

**References**

Mini 31 12 6 757 562

Mini 6 757 562

**Application info**

Mini Mini I (06/01-07/08)

**Mount, control arm**

314 610 0004/HD

MCB0225HD

**Notes**

Carbon Neutral  
Front  
Front Axle Left  
Front Axle Right  
Lower  
without holder

Height [mm] 90  
Inner Diameter [mm] 12  
Outer Diameter [mm] 70  
Replace in pairs only  
Required quantity 2  
reinforced version



**References**

BMW 31 10 6 778 015 BMW 31 12 6 851 693  
BMW 31 12 6 863 171 BMW 6 778 015  
BMW 6 851 693 BMW 6 863 171

**Application info**

BMW X5 (E70) (02/06-07/13) BMW X5 (F15) (08/13-07/18)  
BMW X6 (E71) (06/07-07/14) BMW X6 (F16) (08/14-07/19)

**Mount, control arm**

314 610 0005

MCB0351

**Notes**

Front Axle Left  
Front Axle Right  
outer  
without holder

Height [mm] 50  
Inner Diameter [mm] 14  
Outer Diameter [mm] 43  
Required quantity 2  
replacement in pairs recommended



**References**

BMW 31 10 6 771 897 BMW 31 12 6 855 509  
BMW 6 771 897 BMW 6 855 509



**Application info**

BMW X5 (E70) (02/06-07/13)  
 BMW X5 (G05) (08/18--)  
 BMW X6 (F16) (08/14-07/19)  
 BMW X7 (G07) (03/19--)

BMW X5 (F15) (08/13-07/18)  
 BMW X6 (E71) (06/07-07/14)  
 BMW X6 (G06) (08/19--)  
 BMW iX (I20) (07/21--)

**Mount, control arm**

314 610 0006

MCB0352

**Notes**

Front Axle Left  
 Front Axle Right  
 inner  
 without holder

Height [mm] 55  
 Inner Diameter [mm] 14  
 Outer Diameter [mm] 43  
 Required quantity 2  
 replacement in pairs recommended



**References**

BMW 31 10 6 771 194

BMW 6 771 194

**Application info**

BMW X5 (E70) (02/06-07/13)

BMW X6 (E71) (06/07-07/14)

**Mount, control arm**

314 610 0007

MCB0226

**Notes**

Front  
 Front Axle Left  
 Front Axle Right  
 without holder

Height [mm] 56  
 Inner Diameter [mm] 12  
 Outer Diameter [mm] 47  
 Required quantity 2  
 replacement in pairs recommended



**References**

BMW 31 12 6 768 989

BMW 6 768 989

BMW (Brilliance) 31 12 6 768 989

BMW (Brilliance) 6 768 989

**Application info**

BMW 3 (E90, E91, E92, E93) (02/04-12/13)

BMW X1 (E84) (03/09-06/15)

**Mount, control arm**

314 610 0008/HD

MCB0227HD

**Notes**

Carbon Neutral  
 Front  
 Front Axle Left  
 Front Axle Right  
 Rear  
 Upper  
 without holder



Height [mm] 52  
 Inner Diameter [mm] 10  
 Outer Diameter [mm] 40  
 Replace in pairs only  
 Required quantity 4  
 reinforced version

**References**

BMW 31 10 6 868 530  
 BMW 31 12 6 775 981  
 BMW 31 12 6 779 908  
 BMW 6 775 981  
 BMW 6 779 908  
 BMW (Brilliance) 31 12 6 775 967

BMW 31 12 6 775 967  
 BMW 31 12 6 779 871  
 BMW 6 775 967  
 BMW 6 779 871  
 BMW 6 868 530  
 BMW (Brilliance) 6 775 967

**Application info**

BMW 5 (F07) (01/09-02/17)  
 BMW 6 (F12, F13) (12/10-10/18)  
 BMW 7 (F01, F02, F03, F04) (02/08-12/15)

BMW 5 (F10, F11) (01/09-02/17)  
 BMW 6 (G32) (06/17--)  
 BMW 7 (G11, G12) (07/15--)

**Mount, control arm**

314 610 0009/HD

MCM0117HD

**Notes**

Carbon Neutral  
 Front Axle Right  
 with holder



Inner Diameter [mm] 20  
 Paired article number 314 610 0010/HD | MCM0118HD  
 Replace in pairs only  
 Required quantity 1  
 reinforced version

**References**

Mini 31 12 6 772 236

Mini 6 772 236

**Application info**

Mini Mini II (11/05-12/15)

**Mount, control arm**

314 610 0010/HD

MCM0118HD

**Notes**

Carbon Neutral  
Front Axle Left  
with holder

Inner Diameter [mm]

20

Paired article number

314 610 0009/HD | MCM0117HD

Replace in pairs only

Required quantity

1

reinforced version



**References**

Mini 31 12 6 772 235

Mini 6 772 235

**Application info**

Mini Mini II (11/05-12/15)

**Mount, control arm**

314 610 0013

MCB0229

**Notes**

Front Axle Left  
Front Axle Right  
Lower  
Rear  
inner  
without holder

Height [mm]

90

Inner Diameter [mm]

14

Outer Diameter [mm]

56

Required quantity

2

replacement in pairs recommended



**References**

BMW 31 12 6 775 963  
 BMW 31 12 6 775 980  
 BMW 31 12 6 794 203  
 BMW 31 12 6 798 107  
 BMW 31 12 6 850 781  
 BMW 6 775 963  
 BMW 6 775 980  
 BMW 6 794 203  
 BMW 6 798 107  
 BMW 6 850 781  
 BMW (Brilliance) 31 12 6 794 203

BMW 31 12 6 775 964  
 BMW 31 12 6 791 455  
 BMW 31 12 6 794 204  
 BMW 31 12 6 798 108  
 BMW 31 12 6 850 782  
 BMW 6 775 964  
 BMW 6 791 455  
 BMW 6 794 204  
 BMW 6 798 108  
 BMW 6 850 782  
 BMW (Brilliance) 6 794 203

**Application info**

BMW 5 (F07) (01/09-02/17)  
 BMW 6 (F12, F13) (12/10-10/18)

BMW 5 (F10, F11) (01/09-02/17)  
 BMW 7 (F01, F02, F03, F04) (02/08-12/15)

**Mount, control arm**

**314 610 0015**

**MCB0471**

**Notes**

Front Axle Left  
 Front Axle Right  
 Rear  
 outer  
 without holder

Height [mm] 55  
 Inner Diameter [mm] 14  
 Outer Diameter [mm] 43  
 Required quantity 2  
 replacement in pairs recommended



**References**

BMW 31 10 6 861 177	BMW 31 10 6 861 178
BMW 31 12 6 775 963	BMW 31 12 6 775 964
BMW 31 12 6 777 743	BMW 31 12 6 777 744
BMW 31 12 6 794 203	BMW 31 12 6 794 204
BMW 31 12 6 798 107	BMW 31 12 6 798 108
BMW 31 12 6 850 605	BMW 31 12 6 850 606
BMW 31 12 6 850 781	BMW 31 12 6 850 782
BMW 6 775 963	BMW 6 775 964
BMW 6 777 743	BMW 6 777 744
BMW 6 794 203	BMW 6 794 204
BMW 6 798 107	BMW 6 798 108
BMW 6 850 605	BMW 6 850 606
BMW 6 850 781	BMW 6 850 782
BMW 6 861 177	BMW 6 861 178
BMW (Brilliance) 31 12 6 794 203	BMW (Brilliance) 6 794 203

**Application info**

BMW 5 (F07) (01/09-02/17)	BMW 5 (F10, F11) (01/09-02/17)
BMW 5 (G30, G31) (09/16--)	BMW 6 (F12, F13) (12/10-10/18)
BMW 6 (G32) (06/17--)	BMW 7 (F01, F02, F03, F04) (02/08-12/15)
BMW 7 (G11, G12) (07/15--)	

**Mount, control arm**

314 610 0016

MCB0465

**Notes**

Front Axle Left  
 Front Axle Right  
 Rear  
 inner  
 without holder

Height [mm] 71  
 Inner Diameter [mm] 14  
 Outer Diameter [mm] 56  
 Required quantity 2  
 replacement in pairs recommended



**References**

BMW 31 10 6 861 177  
 BMW 31 12 6 777 743  
 BMW 31 12 6 850 605  
 BMW 31 12 6 861 156  
 BMW 6 777 744  
 BMW 6 850 606  
 BMW 6 861 177

BMW 31 10 6 861 178  
 BMW 31 12 6 777 744  
 BMW 31 12 6 850 606  
 BMW 6 777 743  
 BMW 6 850 605  
 BMW 6 861 156  
 BMW 6 861 178

**Application info**

BMW 5 (F07) (01/09-02/17)  
 BMW 5 (G30, G31) (09/16--)  
 BMW 6 (G32) (06/17--)  
 BMW X5 (G05) (08/18--)  
 BMW X7 (G07) (03/19--)

BMW 5 (F10, F11) (01/09-02/17)  
 BMW 6 (F12, F13) (12/10-10/18)  
 BMW 7 (G11, G12) (07/15--)  
 BMW X6 (G06) (08/19--)  
 BMW iX (I20) (07/21--)

**Mount, control arm****314 610 0023/HD****MCB0448HD****Notes**

Carbon Neutral  
 Front Axle Left  
 Front Axle Right  
 without holder

Height [mm] 80  
 Inner Diameter [mm] 12  
 Outer Diameter [mm] 70  
 Replace in pairs only  
 Required quantity 2  
 reinforced version

**References**

BMW 31 12 6 854 729  
 BMW (Brilliance) 31 12 6 854 729

BMW 6 854 729  
 BMW (Brilliance) 6 854 729

**Application info**

BMW 1 (F20, F21) (07/11--)  
 BMW 3 (E30) (09/82-10/94)  
 BMW 3 (F34) (07/12--)

BMW 2 (F22, F23) (10/12--)  
 BMW 3 (F30, F31) (11/11-06/19)  
 BMW 4 (F32, F33, F36) (07/13--)

**Mount, control arm** **314 610 0042** **MCB0537**

**Notes**

Front  
 Front Axle Left  
 Front Axle Right  
 Lower  
 inner  
 without holder

Height [mm] 85  
 Inner Diameter [mm] 14  
 Outer Diameter [mm] 70  
 Required quantity 2  
 replacement in pairs recommended



**References**

BMW 31 10 6 861 161	BMW 31 10 6 861 162
BMW 31 12 6 831 187	BMW 31 12 6 861 187
BMW 6 831 187	BMW 6 861 161
BMW 6 861 162	BMW 6 861 187
BMW (Brilliance) 31 10 6 861 161	BMW (Brilliance) 31 10 6 861 162
BMW (Brilliance) 6 861 161	BMW (Brilliance) 6 861 162

**Application info**

BMW 5 (G30, G31) (09/16--)	BMW 6 (G32) (06/17--)
----------------------------	-----------------------

**Mount, control arm** **314 610 0044/HD** **MCB0552HD**

**Notes**

Carbon Neutral  
 Front  
 Front Axle Left  
 Front Axle Right  
 Lower  
 Rubber/Metal  
 for control arm  
 inner  
 without holder

Height [mm] 85  
 Inner Diameter [mm] 12  
 Outer Diameter [mm] 75  
 Replace in pairs only  
 Required quantity 2  
 reinforced version



**References**

- |                     |                     |
|---------------------|---------------------|
| BMW 31 10 6 870 977 | BMW 31 10 6 879 847 |
| BMW 31 10 6 879 848 | BMW 31 10 6 880 301 |
| BMW 31 10 6 890 903 | BMW 31 10 6 890 905 |
| BMW 31 10 6 894 653 | BMW 31 10 6 894 661 |
| BMW 31 10 6 894 662 | BMW 31 10 6 894 667 |
| BMW 31 10 6 894 668 | BMW 31 10 6 894 675 |
| BMW 31 10 6 894 676 | BMW 6 870 977       |
| BMW 6 879 847       | BMW 6 879 848       |
| BMW 6 880 301       | BMW 6 890 903       |
| BMW 6 890 905       | BMW 6 894 653       |
| BMW 6 894 661       | BMW 6 894 662       |
| BMW 6 894 668       | BMW 6 894 675       |
| BMW 6 894 676       | BMW 6 984 667       |

**Application info**

- |                                 |                            |
|---------------------------------|----------------------------|
| BMW 2 (G42) (08/21--)           | BMW 3 (G20, G21) (11/18--) |
| BMW 4 (G22, G23, G26) (07/20--) | BMW X3 (G01) (07/17--)     |
| BMW X4 (G02) (04/18--)          | BMW iX3 (09/20--)          |

**Mount, control arm**

314 610 0045

MCM0210

**Notes**

- Front Axle Left
- Front Axle Right
- Lower
- Rear
- inner
- without holder

- Height [mm] 70
- Inner Diameter [mm] 12
- Outer Diameter [mm] 56
- Required quantity 2
- replacement in pairs recommended



**References**

- |                     |                     |
|---------------------|---------------------|
| BMW 31 10 6 870 971 | BMW 31 10 6 870 972 |
| BMW 6 870 971       | BMW 6 870 972       |

**Application info**

- |                        |                        |
|------------------------|------------------------|
| BMW X3 (G01) (07/17--) | BMW X4 (G02) (04/18--) |
| BMW iX3 (09/20--)      |                        |



## Mount, control arm

314 610 0048/HD

MCB0540HD

## Notes

Carbon Neutral  
 Front  
 Front Axle Left  
 Front Axle Right  
 inner  
 without holder

Height [mm] 85  
 Inner Diameter [mm] 15  
 Outer Diameter [mm] 75  
 Replace in pairs only  
 Required quantity 2



## References

BMW 31 10 6 861 151  
 BMW 6 861 151

BMW 31 10 6 861 152  
 BMW 6 861 152

## Application info

BMW 6 (G32) (06/17--)

BMW 7 (G11, G12) (07/15--)

## Mount, control arm

314 610 0052/HD

MCB0564HD

## Notes

Carbon Neutral  
 Front Axle Left  
 Front Axle Right  
 Rubber-Metal Mount  
 Rubber/Metal  
 without holder

Height [mm] 90  
 Inner Diameter [mm] 15  
 Outer Diameter [mm] 76  
 Replace in pairs only  
 Required quantity 2  
 reinforced version



## References

BMW 31 10 6 878 074  
 BMW 31 10 6 893 550  
 BMW 6 893 549

BMW 31 10 6 893 549  
 BMW 6 878 074  
 BMW 6 893 550

**Application info**

BMW X5 (G05) (08/18--)  
 BMW X7 (G07) (03/19--)

BMW X6 (G06) (08/19--)

**Mount, control arm**

314 710 0005

MCB0232

**Notes**

Rear  
 Rear Axle Left  
 Rear Axle Right  
 Upper  
 inner  
 without holder

Height [mm] 48  
 Inner Diameter [mm] 12  
 Outer Diameter [mm] 45  
 Required quantity 2  
 replacement in pairs recommended



**References**

BMW 33 32 6 763 473  
 BMW 33 32 6 777 980  
 BMW 34 52 6 778 469  
 BMW 6 767 190  
 BMW 6 778 469  
 BMW (Brilliance) 33 32 6 763 473  
 BMW (Brilliance) 6 763 473

BMW 33 32 6 767 190  
 BMW 33 32 6 782 168  
 BMW 6 763 473  
 BMW 6 777 980  
 BMW 6 782 168  
 BMW (Brilliance) 33 32 6 777 980  
 BMW (Brilliance) 6 777 980

**Application info**

BMW 1 (E81, E82, E87, E88) (02/03-12/13)  
 BMW X1 (E84) (03/09-06/15)

BMW 3 (E90, E91, E92, E93) (02/04-12/13)

**Mount, control arm** **314 710 0006** **MCB0233**

**Notes**

Rear  
Rear Axle Left  
Rear Axle Right  
Upper  
outer  
without holder

Height [mm] 50  
Inner Diameter [mm] 12  
Outer Diameter [mm] 46  
Required quantity 2  
replacement in pairs recommended



**References**

BMW 33 32 6 763 473	BMW 33 32 6 777 980
BMW 34 52 6 778 469	BMW 6 763 473
BMW 6 777 980	BMW 6 778 469
BMW (Brilliance) 33 32 6 763 473	BMW (Brilliance) 33 32 6 777 980
BMW (Brilliance) 6 763 473	BMW (Brilliance) 6 777 980

**Application info**

BMW 1 (E81, E82, E87, E88) (02/03-12/13)	BMW 3 (E90, E91, E92, E93) (02/04-12/13)
--	--

**Mount, control arm** **314 710 0028** **MCB0528**

**Notes**

Rear Axle Left  
Rear Axle Right  
outer  
without holder

Height [mm] 48  
Inner Diameter [mm] 12  
Outer Diameter [mm] 45  
Required quantity 2  
replacement in pairs recommended





**References**

BMW 33 30 6 786 980	BMW 6 786 980
---------------------	---------------

**Application info**

BMW X3 (F25) (09/10-08/17)	BMW X4 (F26) (05/13-03/18)
----------------------------	----------------------------

Mount, control arm		314 710 0031	MCM0185
<p><b>Notes</b></p> <p>Molecular Bearing Rear Axle Left Rear Axle Right outer with retaining ring without holder</p> <p>Height [mm] 60.3 Inner Diameter [mm] 16.1 Outer Diameter [mm] 52 Required quantity 2 replacement in pairs recommended</p>			
<p><b>References</b></p> <p>BMW 33 32 6 780 438 BMW 6 780 438 BMW (Brilliance) 33 32 6 780 438 BMW (Brilliance) 6 780 438</p>			
<p><b>Application info</b></p> <p>BMW 5 (F07) (01/09-02/17) BMW 5 (F10, F11) (01/09-02/17) BMW 6 (F12, F13) (12/10-10/18) BMW 7 (F01, F02, F03, F04) (02/08-12/15)</p>			
Mount, control arm		314 710 0043	MCB0536
<p><b>Notes</b></p> <p>Centre Rear Axle Left Rear Axle Right Rubber/Metal Upper inner without holder</p> <p>Height [mm] 60 Inner Diameter [mm] 14.1 Outer Diameter [mm] 51 Required quantity 4 replacement in pairs recommended</p>			
<p><b>References</b></p> <p>BMW 33 32 6 861 119 BMW 33 32 6 861 120 BMW 6 861 119 BMW 6 861 120</p>			
<p><b>Application info</b></p> <p>BMW 5 (G30, G31) (09/16--) BMW 6 (G32) (06/17--)</p>			

**Mount, stabilizer**

18-14 615 0000

MSB0150

**Notes**

Front Axle Left  
Front Axle Right

Inner Diameter [mm] 31  
Outer Diameter [mm] 51  
Required quantity 2

**References**

Jaguar XR814128

Jaguar XR819697

**Application info**

Jaguar S-Type (CCX) (10/98-12/08)

Jaguar XJ (X350) (03/03-03/09)

Jaguar XK (03/06-12/14)

Jaguar XK 8 (QDV, QEV) (03/96-12/06)

**Mount, wheel bearing housing**

314 710 0017

MCX0455

**Notes**

Rear  
Rear Axle Left  
Rear Axle Right

Height [mm] 62  
Inner Diameter [mm] 14  
Outer Diameter [mm] 47  
Required quantity 2  
replacement in pairs recommended

**References**

BMW 2 457 418

BMW 33 32 2 457 418

BMW 33 32 6 790 493

BMW 6 790 493

**Application info**

BMW X3 (F25) (09/10-08/17)

BMW X4 (F26) (05/13-03/18)

**Repair kit, ball joint**

28-16 010 0017

MAX0149

**Notes**

Front Axle Left  
 Front Axle Right  
 Lower  
 outer

**References**

Hyundai 51760-2R000

Kia 51760 2R000

**Application info**

Hyundai i30 I (10/07-06/12)

Kia Cee'd I (12/06-02/13)

**Rod/strut, suspension**

116 050 0059

MSR0067

**Notes**

Aluminium  
 Guide Rod  
 Rear  
 Rear Axle Left  
 Upper  
 with rubber mount

Length [mm]

360

Paired article number

116 050 0060 | MSR0068

Required quantity

1

replacement in pairs recommended

**References**

Audi 7L0 505 397

Porsche 955 331 049 00

Volkswagen 7L0 505 397

**Application info**



Audi Q7 I (4L\_) (03/06-01/16)

Porsche Cayenne I (955) (09/02-12/10)

Porsche Cayenne II (92A) (06/10--)

Volkswagen Touareg I (7LA, 7L6, 7L7) (10/02-01/13)

Volkswagen Touareg II (7P5) (01/10-12/18)

Rod/strut, suspension		116 050 0060	MSR0068
<b>Notes</b>  Aluminium Guide Rod Rear Rear Axle Right Upper with rubber mount  Length [mm] 360 Paired article number 116 050 0059   MSR0067 Required quantity 1 replacement in pairs recommended			
<b>References</b> Audi 7L0 505 398 Porsche 955 331 050 00 Volkswagen 7L0 505 398			
<b>Application info</b> Audi Q7 I (4L_) (03/06-01/16) Porsche Cayenne I (955) (09/02-12/10) Porsche Cayenne II (92A) (06/10-- ) Volkswagen Touareg I (7LA, 7L6 ,7L7 ) (10/02-01/13) Volkswagen Touareg II (7P5 ) (01/10-12/18)			
Rod/strut, suspension		15-16 030 0000	MSR0077
<b>Notes</b>  Coupling Rod Rear Rear Axle Sheet Steel  Length [mm] 592 Required quantity 2 replacement in pairs recommended			
<b>References</b> Alfa Romeo 51749713 Alfa Romeo 60652167			
<b>Application info</b> Alfa Romeo 147 (10/00-12/10) Alfa Romeo 156 (02/97-05/06) Alfa Romeo GT (937) (11/03-09/10)			

## Rod/strut, suspension

15-16 030 0001

MSR0078

## Notes

Coupling Rod

Front

Rear Axle

Sheet Steel

Length [mm]

560

Required quantity

2

replacement in pairs recommended



## References

Alfa Romeo 46802682

Alfa Romeo 60629903

Alfa Romeo 60676173

## Application info

Alfa Romeo 147 (10/00-12/10)

Alfa Romeo 156 (02/97-05/06)

Alfa Romeo GT (937) (11/03-09/10)

## Stabilizer link

116 060 0000/HD

MSL0107HD

## Notes

Carbon Neutral

Coupling Rod

Front Axle Left

Front Axle Right

with spanner attachment

Length [mm]

270

Required quantity

2

Thread Size 1

M10x1,5

Thread Size 2

M10x1,5

reinforced version

replacement in pairs recommended



## References

The references of this product can be found at [www.meyle.com](http://www.meyle.com)



**Application info**

Audi A1 I (8X_) (05/10-10/18)	Audi A1 II (GB_) (07/18--)
Audi A2 (8Z0) (02/00-08/05)	Seat Arona (KJ7) (07/17--)
Seat Ibiza III / Cordoba II (6L_) (02/02-11/09)	Seat Ibiza IV (6J_ ,6P_) (03/08-12/18)
Seat Ibiza V (KJ1) (01/17--)	Seat Mii (10/11--)
Seat Toledo IV (KG3) (07/12-04/19)	Skoda Citigo (10/11--)
Skoda Fabia I (6Y_) (08/99-03/08)	Skoda Fabia II (54_) (12/06-12/14)
Skoda Fabia III (NJ_) (08/14--)	Skoda Fabia IV (PJ3) (06/21--)
Skoda Kamiq (07/19--)	Skoda Rapid II (N_) (07/12-12/19)
Skoda Roomster (03/06-05/15)	Skoda Scala (02/19--)
Volkswagen Fox/Lupo (Z51) (08/03--)	Volkswagen Nivus / Taigo (11/21--)
Volkswagen Polo (6R_) (03/09--)	Volkswagen Polo (9N_) (10/01--)
Volkswagen Polo (AW1) (06/17--)	Volkswagen Polo Vivo (6S1, 6S3) (02/10-09/17)
Volkswagen Polo Vivo (6R1, 6RS) (07/17--)	Volkswagen T-Cross (12/18--)
Volkswagen UP (08/11--)	

**Stabilizer link****116 060 0002/HD****MSL0109HD****Notes**

Carbon Neutral  
Coupling Rod  
Rear Axle Left  
Rear Axle Right  
for vehicles with bad road version  
with spanner attachment



Length [mm]

195

Required quantity

2

Thread Size 1

M10x1,5

reinforced version

replacement in pairs recommended

**References**

Audi 1J0 505 466 C

Skoda 1J0 505 466 C

Volkswagen 1J0 505 466 C

**Application info**

Audi A3 I (8L_) (09/96-09/06)	Audi TT I (8N_) (10/98-12/06)
Skoda Octavia I (1U_) (09/96-12/10)	Volkswagen Bora (1J2, 1J6) (10/98-12/13)
Volkswagen Golf IV (1J1, 1J5) (08/97-06/14)	

**Stabilizer link**

116 060 0003/HD

MSL0110HD

**Notes**

Carbon Neutral  
Coupling Rod  
Front Axle Left  
Front Axle Right  
with spanner attachment

Length [mm] 205  
Required quantity 2  
Thread Size 1 M12x1,5  
Thread Size 2 M12X1,5  
reinforced version  
replacement in pairs recommended

**References**

Ford 1 009 591	Ford 1 141 774
Ford 1 353 188	Ford 1 361 653
Ford 1M21-5489-AA	Ford 3M21-5489-AA
Ford 3M21-5489-AB	Ford 7 200 959
Ford 95VW-5489-AB	Ford 95VW-5489-AC
Seat 7M0 411 317 D	Seat 7M3 411 317
Seat 7M3 411 317 C	Seat 7M3 411 317 E
Volkswagen 7M0 311 317	Volkswagen 7M0 411 317 C
Volkswagen 7M0 411 317 D	Volkswagen 7M3 411 317
Volkswagen 7M3 411 317 B	Volkswagen 7M3 411 317 C
Volkswagen 7M3 411 317 E	

**Application info**

Ford Galaxy I (03/95-05/06)      Seat Alhambra I (7V8, 7V9) (03/96-03/10)  
Volkswagen Sharan (7M) (05/95-03/10)

**Stabilizer link**

116 060 0007

MSL0114

**Notes**

Aluminium  
Coupling Rod  
Front Axle Left

Length [mm] 90  
Paired article number 116 060 0008 | MSL0115  
Required quantity 1  
replacement in pairs recommended



**References**

Audi 4D0 411 317 J  
 Audi (FAW) 8D0 411 317 D  
 Volkswagen 4D0 411 317 J  
 Volkswagen (SVW) 8D0 411 317 D

Audi 8D0 411 317 D  
 Skoda 8D0 411 317 D  
 Volkswagen 8D0 411 317 D

**Application info**

Audi A4 I (8D\_) (11/94-12/02)  
 Skoda Superb I (3U) (12/01-03/08)

Audi A6 II (4B, C5) (01/97-12/05)  
 Volkswagen Passat (3B\_) (08/96-12/05)

**Stabilizer link**

116 060 0008

MSL0115

**Notes**

Aluminium  
 Coupling Rod  
 Front Axle Right  
 Length [mm] 90  
 Paired article number 116 060 0007 | MSL0114  
 Required quantity 1  
 replacement in pairs recommended



**References**

Audi 4D0 411 317 J  
 Audi (FAW) 8D0 411 318 D  
 Volkswagen 4D0 411 317 J  
 Volkswagen 8D0 411 318 D

Audi 8D0 411 318 D  
 Skoda 8D0 411 318 D  
 Volkswagen 4D0 411 318 G  
 Volkswagen (SVW) 8D0 411 318 D

**Application info**

Audi A4 I (8D\_) (11/94-12/02)  
 Skoda Superb I (3U) (12/01-03/08)

Audi A6 II (4B, C5) (01/97-12/05)  
 Volkswagen Passat (3B\_) (08/96-12/05)

**Stabilizer link**

116 060 0009

MSL0116

**Notes**

Coupling Rod  
 Front Axle Left  
 Front Axle Right  
 Inner Diameter [mm] 9  
 Length [mm] 51  
 Required quantity 2  
 Thread Size 1 M10x1,5  
 replacement in pairs recommended



**References**

Seat 1H0 411 315

Seat 535 411 315

Volkswagen 535 411 315

**Application info**

Seat Toledo I (1L\_) (01/91-10/99)

Volkswagen Corrado (53I) (08/87-12/95)

Volkswagen Golf III (1H1, 1H5, 1E7) (10/89-12/02)

Volkswagen Vento (11/91-09/98)

**Stabilizer link**

116 060 0010

MSL0117

**Notes**

Coupling Rod  
Front Axle Left  
Front Axle Right  
Steel

Length [mm]

108

Required quantity

2

Stabiliser Diameter [mm]

27

Thread Size 1

M12x1,5

replacement in pairs recommended



**References**

Volkswagen 701 411 049 B

**Application info**

Volkswagen Transporter IV (07/90-06/03)

**Stabilizer link**

116 060 0011/HD

MSL0118HD

**Notes**

Carbon Neutral  
Coupling Rod  
Front Axle Left  
with spanner attachment

Length [mm]

336

Paired article number

116 060 0012/HD | MSL0119HD

Required quantity

1

Thread Size 1

M12x1,5

Thread Size 2

M12x1,5

reinforced version

replacement in pairs recommended



**References**

Audi 1J0 411 315 D

Seat 1J0 411 315 D

Skoda 1J0 411 315 D

Volkswagen 1J0 411 315 D

**Application info**

Audi A3 I (8L\_) (09/96-09/06)

Seat Leon I / Toledo II (1M\_) (10/98-06/06)

Volkswagen Bora (1J2, 1J6) (10/98-12/13)

Volkswagen New Beetle (1Y7, 9C1, 1C1) (01/98-12/11)

Audi TT I (8N\_) (10/98-12/06)

Skoda Octavia I (1U\_) (09/96-12/10)

Volkswagen Golf IV (1J1, 1J5) (08/97-06/14)

**Stabilizer link****116 060 0012/HD****MSL0119HD****Notes**

Carbon Neutral  
Coupling Rod  
Front Axle Right  
with spanner attachment

Length [mm]

336

Paired article number

116 060 0011/HD | MSL0118HD

Required quantity

1

Thread Size 1

M12x1,5

Thread Size 2

M12x1,5

reinforced version

replacement in pairs recommended

**References**

Audi 1J0 411 316 D

Skoda 1J0 411 316 D

Seat 1J0 411 316 D

Volkswagen 1J0 411 316 D

**Application info**

Audi A3 I (8L\_) (09/96-09/06)

Seat Leon I / Toledo II (1M\_) (10/98-06/06)

Volkswagen Bora (1J2, 1J6) (10/98-12/13)

Volkswagen New Beetle (1Y7, 9C1, 1C1) (01/98-12/11)

Audi TT I (8N\_) (10/98-12/06)

Skoda Octavia I (1U\_) (09/96-12/10)

Volkswagen Golf IV (1J1, 1J5) (08/97-06/14)

**Stabilizer link****116 060 0015/HD****MSL0121HD****Notes**

Carbon Neutral  
Coupling Rod  
Rear Axle Left  
Rear Axle Right  
with spanner attachment

Inner Diameter [mm]

14

Length [mm]

175

Required quantity

2

Thread Size 1

M10x1,5

reinforced version

replacement in pairs recommended



**References**

Audi 1J0 505 466 B

Seat 1J0 505 466 B

Volkswagen 1J0 505 466 B

**Application info**

Audi A3 I (8L\_) (09/96-09/06)

Audi TT I (8N\_) (10/98-12/06)

Seat Leon I / Toledo II (1M\_) (10/98-06/06)

Volkswagen Bora (1J2, 1J6) (10/98-12/13)

Volkswagen Golf IV (1J1, 1J5) (08/97-06/14)

Volkswagen New Beetle (1Y7, 9C1, 1C1) (01/98-12/11)

**Stabilizer link**

116 060 0016

MSL0122

**Notes**

Aluminium  
Coupling Rod  
Front Axle Left  
white

Length [mm]

90

Paired article number

116 060 0017 | MSL0123

Required quantity

1

replacement in pairs recommended



**References**

Audi 8E0 411 317

Audi (FAW) 8E0 411 317

Seat 8E0 411 317

**Application info**

Audi A4 Cabriolet (8H\_) (01/02-12/09)

Audi A4 II (8E\_) (02/00-12/05)

Audi A4 III (8E\_) (11/04-06/08)

Seat Exeo (3R) (12/08-05/13)

**Stabilizer link**

116 060 0017

MSL0123

**Notes**

Aluminium  
Coupling Rod  
Front Axle Right

Length [mm]

90

Paired article number

116 060 0016 | MSL0122

Required quantity

1

replacement in pairs recommended



**References**

Audi 8E0 411 318

Audi (FAW) 8E0 411 318

Seat 8E0 411 318

**Application info**

Audi A4 Cabriolet (8H\_) (01/02-12/09)  
Audi A4 III (8E\_) (11/04-06/08)

Audi A4 II (8E\_) (02/00-12/05)  
Seat Exeo (3R) (12/08-05/13)

**Stabilizer link****116 060 0018****MSL0124****Notes**

Aluminium  
Coupling Rod  
Front Axle Left  
Front Axle Right

Inner Diameter [mm] 12  
Length [mm] 110  
Required quantity 2  
replacement in pairs recommended

**References**

Audi 4E0 411 317 D  
Volkswagen 4E0 411 317 D

Volkswagen 3D0 411 317

**Application info**

Audi A8 II (4E\_) (10/02-12/10)

Volkswagen Phaeton (3D) (04/02-03/16)

**Stabilizer link****116 060 0021/HD****MSL0126HD****Notes**

Carbon Neutral  
Coupling Rod  
Rear Axle Left  
Inner Diameter 1 [mm] 12  
Length [mm] 200  
Paired article number 116 060 0022/HD | MSL0127HD  
Required quantity 1  
Thread Size 1 M12x1,5

reinforced version  
replacement in pairs recommended

**References**

Audi 7L0 505 465 C  
Audi 7L8 505 465 B  
Porsche 955 333 069 11  
Volkswagen 7L0 505 465 A  
Volkswagen 7L0 505 465 C

Audi 7L0 505 465 D  
Porsche 955 333 069 10  
Porsche 955 333 069 21  
Volkswagen 7L0 505 465 B  
Volkswagen 7L0 505 465 D

**Application info**

Audi Q7 I (4L\_) (03/06-01/16)

Porsche Cayenne I (955) (09/02-12/10)

Volkswagen Touareg I (7LA, 7L6 ,7L7 ) (10/02-01/13)

Audi Q7 II (4M\_) (01/15--)

Porsche Cayenne II (92A) (06/10--)

Volkswagen Touareg II (7P5 ) (01/10-12/18)

**Stabilizer link**

**116 060 0022/HD**

**MSL0127HD**

**Notes**

Carbon Neutral  
Rear Axle Right  
Suspension Rod

Length [mm]

250

Paired article number

116 060 0021/HD | MSL0126HD

Required quantity

1

Thread Size 1

M12x1,5

reinforced version

replacement in pairs recommended



**References**

Audi 7L0 505 466 C

Audi 7L8 505 466 B

Porsche 955 333 070 11

Volkswagen 7L0 505 466 A

Volkswagen 7L0 505 466 C

Audi 7L0 505 466 D

Porsche 955 333 070 10

Porsche 955 333 070 21

Volkswagen 7L0 505 466 B

Volkswagen 7L0 505 466 D

**Application info**

Audi Q7 I (4L\_) (03/06-01/16)

Porsche Cayenne I (955) (09/02-12/10)

Volkswagen Touareg I (7LA, 7L6 ,7L7 ) (10/02-01/13)

Audi Q7 II (4M\_) (01/15--)

Porsche Cayenne II (92A) (06/10--)

Volkswagen Touareg II (7P5 ) (01/10-12/18)

**Stabilizer link**

**116 060 0023**

**MSL0128**

**Notes**

Coupling Rod  
Rear Axle Left  
Rear Axle Right

Inner Diameter [mm]

10

Length [mm]

95

Required quantity

2

Thread Size 1

M10x1,5

replacement in pairs recommended





**References**

Audi 1K0 505 465 AA  
 Audi 1K0 505 465 K  
 Audi (FAW) 1KD 505 465  
 Seat 1K0 505 465 J  
 Seat 1K0 505 465 R  
 Skoda 1K0 505 465 K  
 Skoda (SVW) 1KD 505 465  
 Volkswagen 1K0 505 465 C  
 Volkswagen 1K0 505 465 K  
 Volkswagen (FAW) 1KD 505 465

Audi 1K0 505 465 J  
 Audi 1K0 505 465 R  
 Seat 1K0 505 465 AA  
 Seat 1K0 505 465 K  
 Skoda 1K0 505 465 AA  
 Skoda 1K0 505 465 R  
 Volkswagen 1K0 505 465 AA  
 Volkswagen 1K0 505 465 J  
 Volkswagen 1K0 505 465 R  
 Volkswagen (SVW) 1KD 505 465

**Application info**

Audi A1 I (8X\_) (05/10-10/18)  
 Audi Q3 I (8U\_) (06/11-12/18)  
 Seat Alhambra II (710) (06/10--)  
 Skoda Octavia II (1Z\_) (02/04-06/13)  
 Skoda Yeti (5L) (05/09-12/17)  
 Volkswagen CC (11/11-12/16)  
 Volkswagen Golf V (1K1, 1K5, 5M1) (10/03-08/14)  
 Volkswagen Jetta III (1K2) (09/04-12/13)  
 Volkswagen Passat (362, 365) (08/10-12/15)  
 Volkswagen Passat (A32) (01/11--)  
 Volkswagen Sharan (7N) (05/10--)  
 Volkswagen Touran I (1T1/2/3) (02/03-05/15)

Audi A3 II (8P\_) (05/03-12/15)  
 Audi TT II (8J\_) (07/06-01/15)  
 Seat Leon II / Toledo III / Altea (1P\_ ,5P\_) (03/04--)  
 Skoda Superb II (3T) (03/08-05/15)  
 Volkswagen Beetle (5C1) (04/11-07/19)  
 Volkswagen Eos (03/06-08/15)  
 Volkswagen Golf VI (5K1, 517, AJ5) (10/08-05/16)  
 Volkswagen Jetta IV (162) (01/08--)  
 Volkswagen Passat (3C\_) (03/05-01/12)  
 Volkswagen Scirocco III (137) (05/08-11/17)  
 Volkswagen Tiguan I (5N) (09/07-07/18)

**Stabilizer link**

116 060 0023/S

MSL0129

**Notes**

Coupling Rod  
 Rear Axle Left  
 Rear Axle Right

Inner Diameter [mm] 10  
 Length [mm] 95  
 Required quantity 2  
 Thread Size 1 M10x1,5  
 Thread Size 2 M10x1,5  
 replacement in pairs recommended



**References**

Audi 1K0 505 465 AA	Audi 1K0 505 465 J
Audi 1K0 505 465 K	Audi 1K0 505 465 R
Audi (FAW) 1KD 505 465	Seat 1K0 505 465 AA
Seat 1K0 505 465 J	Seat 1K0 505 465 K
Seat 1K0 505 465 R	Skoda 1K0 505 465 AA
Skoda 1K0 505 465 K	Skoda 1K0 505 465 R
Skoda (SVW) 1KD 505 465	Volkswagen 1K0 505 465 AA
Volkswagen 1K0 505 465 C	Volkswagen 1K0 505 465 J
Volkswagen 1K0 505 465 K	Volkswagen 1K0 505 465 R
Volkswagen (FAW) 1KD 505 465	Volkswagen (SVW) 1KD 505 465

**Application info**

Audi A1 I (8X_) (05/10-10/18)	Audi A3 II (8P_) (05/03-12/15)
Audi Q3 I (8U_) (06/11-12/18)	Audi TT II (8J_) (07/06-01/15)
Seat Alhambra II (710) (06/10--)	Seat Leon II / Toledo III / Altea (1P_ ,5P_) (03/04--)
Skoda Octavia II (1Z_) (02/04-06/13)	Skoda Superb II (3T) (03/08-05/15)
Skoda Yeti (5L) (05/09-12/17)	Volkswagen Beetle (5C1) (04/11-07/19)
Volkswagen CC (11/11-12/16)	Volkswagen Eos (03/06-08/15)
Volkswagen Golf V (1K1, 1K5, 5M1) (10/03-08/14)	Volkswagen Golf VI (5K1, 517, AJ5) (10/08-05/16)
Volkswagen Jetta III (1K2) (09/04-12/13)	Volkswagen Jetta IV (162) (01/08--)
Volkswagen Passat (362, 365) (08/10-12/15)	Volkswagen Passat (3C_) (03/05-01/12)
Volkswagen Passat (A32) (01/11--)	Volkswagen Scirocco III (137) (05/08-11/17)
Volkswagen Sharan (7N) (05/10--)	Volkswagen Tiguan I (5N) (09/07-07/18)
Volkswagen Touran I (1T1/2/3) (02/03-05/15)	

**Stabilizer link****116 060 0024/HD****MSL0130HD****Notes**

Carbon Neutral  
Coupling Rod  
Front Axle Left  
Front Axle Right  
with spanner attachment

Length [mm]

260

Required quantity

2

Thread Size 1

M12x1,5

Thread Size 2

M12x1,5

reinforced version

replacement in pairs recommended



**References**

Volkswagen 7E0 411 317 A  
 Volkswagen 7H0 411 317 A  
 Volkswagen 7H5 411 317 A  
 Volkswagen 7H5 411 317 D

Volkswagen 7H0 411 317  
 Volkswagen 7H5 411 317  
 Volkswagen 7H5 411 317 B  
 Volkswagen 7H5 411 317 E

**Application info**

Volkswagen Multivan T7 (STM, STN) (08/21--)  
 Volkswagen Transporter VI (04/15--)

Volkswagen Transporter V (04/03-08/15)

**Stabilizer link****116 060 0025/HD****MSL0131HD****Notes**

Carbon Neutral  
 Coupling Rod  
 Front Axle Left  
 Front Axle Right  
 Set  
 with spanner attachment

Length [mm] 205  
 Required quantity 1  
 Thread Size 1 M12x1,5  
 Thread Size 2 M12x1,5  
 reinforced version  
 replacement in pairs recommended

**References**

Ford 1 009 591  
 Ford 1 232 756  
 Ford 95VW-5489-AB  
 Seat 7M3 498 317

Ford 1 141 774  
 Ford 1M21-5489-AA  
 Ford 95VW-5489-AC  
 Volkswagen 7M3 498 317

**Application info**

Ford Galaxy I (03/95-05/06)  
 Volkswagen Sharan (7M) (05/95-03/10)

Seat Alhambra I (7V8, 7V9) (03/96-03/10)

**Stabilizer link**

116 060 0026

MSL0132

**Notes**

Coupling Rod  
Plastic  
Rear Axle Left  
Rear Axle Right

Length [mm]

98

Required quantity

2

replacement in pairs recommended

**References**

Audi 4F0 505 465 N

Audi 4F0 505 465 Q

Audi (FAW) 4F0 505 465 Q

**Application info**

Audi A6 III (4F2, 4FH, 4F5) (04/04-08/11)

**Stabilizer link**

116 060 0028

MSL0134

**Notes**

Aluminium  
Coupling Rod  
Front Axle Left  
Front Axle Right

Length [mm]

110

Required quantity

2

replacement in pairs recommended

**References**

Audi 4E0 411 317 C

Audi 4E0 411 317 E



Audi 4E0 411 317 F

Audi (FAW) 4E0 411 317 F

**Application info**

Audi A6 III (4F2, 4FH, 4F5) (04/04-08/11)

Audi A8 II (4E\_) (10/02-12/10)

Stabilizer link		116 060 0029	MSL0135
<p><b>Notes</b></p> <p>Aluminium Coupling Rod Front Axle Left Front Axle Right without fastening material</p> <p>Length [mm] 197 Required quantity 2 replacement in pairs recommended</p>		 <p>MEYLE ORIGINAL QUALITY</p>	
<p><b>References</b></p> <p>Audi 7L0 411 317 Porsche 955 343 069 00 Volkswagen 7L0 411 317</p>			
<p><b>Application info</b></p> <p>Audi Q7 I (4L_) (03/06-01/16) Porsche Cayenne I (955) (09/02-12/10) Porsche Cayenne II (92A) (06/10-- ) Volkswagen Touareg I (7LA, 7L6 ,7L7 ) (10/02-01/13) Volkswagen Touareg II (7P5 ) (01/10-12/18)</p>			
Stabilizer link		116 060 0029/S	MSL0704
<p><b>Notes</b></p> <p>Aluminium Coupling Rod Front Axle Left Front Axle Right with fastening material</p> <p>Length [mm] 197 Required quantity 2 replacement in pairs recommended</p>		 <p>MEYLE ORIGINAL QUALITY</p>	
<p><b>References</b></p> <p>Audi 7L0 411 317 Porsche 955 343 069 00 Volkswagen 7L0 411 317</p>			
<p><b>Application info</b></p> <p>Audi Q7 I (4L_) (03/06-01/16) Porsche Cayenne I (955) (09/02-12/10) Porsche Cayenne II (92A) (06/10-- ) Volkswagen Touareg I (7LA, 7L6 ,7L7 ) (10/02-01/13) Volkswagen Touareg II (7P5 ) (01/10-12/18)</p>			

**Stabilizer link**

116 060 0030/HD

MSL0136HD

**Notes**

Carbon Neutral  
Coupling Rod  
Rear Axle Left  
Rear Axle Right  
with spanner attachment

Length [mm]

241

Required quantity

2

Thread Size 1

M12x1,5

reinforced version

replacement in pairs recommended

**References**

Volkswagen 2K0 505 465 B

Volkswagen 2K0 505 465 C

Volkswagen 2K0 505 465 E

Volkswagen 2K5 505 465

Volkswagen 2K5 505 465 A

Volkswagen (FAW) 2K5 505 465 A

**Application info**

Volkswagen Caddy III (2KA, 2KB) (03/04-05/15)

Volkswagen Caddy IV (SA\_) (05/15--)

**Stabilizer link**

116 060 0035

MSL0141

**Notes**

Coupling Rod  
Plastic  
Rear Axle Left  
Rear Axle Right

Inner Diameter 1 [mm]

10

Inner Diameter 2 [mm]

10

Length [mm]

63

Required quantity

2

replacement in pairs recommended

**References**

Audi 8E0 505 465 C

Audi 8E0 505 465 D

Volkswagen 8E0 505 465 C

Volkswagen 8E0 505 465 D

**Application info**

Audi A6 II (4B, C5) (01/97-12/05)

Audi Allroad (4BH) (05/00-08/05)

Volkswagen Passat (3B\_) (08/96-12/05)

**Stabilizer link****116 060 0036****MSL0142****Notes**

Coupling Rod  
 Plastic  
 Rear Axle Left  
 Rear Axle Right

Inner Diameter 1 [mm] 10  
 Inner Diameter 2 [mm] 10  
 Length [mm] 59  
 Required quantity 2  
 replacement in pairs recommended

**References**

Audi 8K0 505 465 E  
 Audi (FAW) 8K0 505 465 E  
 Volkswagen (SVW) 8K0 505 465 G

Audi 8K0 505 465 G  
 Audi (FAW) 8K0 505 465 G

**Application info**

Audi A4 IV (8K\_) (08/07-05/16)  
 Audi A6 IV (4G2, 4G5, C7) (11/10-09/18)  
 Audi A8 III (4H\_) (11/09-01/18)

Audi A5 I (8F\_ , 8T\_) (06/07-01/17)  
 Audi A7 I Sportback (4G\_) (07/10-05/18)  
 Audi Q5 I (8R\_) (11/08-12/17)

**Stabilizer link****116 060 0037****MSL0143****Notes**

Coupling Rod  
 Rear Axle Left  
 Rear Axle Right

Inner Diameter [mm] 10  
 Length [mm] 99  
 Required quantity 2  
 Thread Size 1 M10x1,5  
 replacement in pairs recommended



**References**

Audi 4F0 505 465 P

Audi (FAW) 4F0 505 465 P

**Application info**

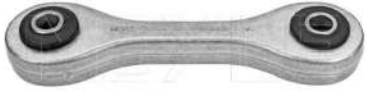
Audi A6 III (4F2, 4FH, 4F5) (04/04-08/11)

Stabilizer link		116 060 0038/HD	MSL0652HD
<p><b>Notes</b></p> <p>Carbon Neutral Coupling Rod Front Axle Left Front Axle Right</p> <p>Length [mm] 145 Required quantity 2 reinforced version replacement in pairs recommended</p>		 	
<p><b>References</b></p> <p>Volkswagen 2H0 411 317</p>		<p>Volkswagen 2H0 411 317 B</p>	
<p><b>Application info</b></p> <p>Volkswagen Amarok I (09/10--)</p>			
Stabilizer link		116 060 0039	MSL0708
<p><b>Notes</b></p> <p>Coupling Rod Rear Axle Left Rear Axle Right</p> <p>Inner Diameter [mm] 8 Length [mm] 70 Required quantity 2 Thread Size 1 M10x1,5 replacement in pairs recommended</p>		 	
<p><b>References</b></p> <p>Audi 5Q0 505 465 A Audi 5WA 505 465 A CUPRA 5Q0505465A Seat 5Q0 505 465 A Seat 5WA 505 465 A Skoda 5Q0 505 465 C Volkswagen 5Q0 505 465 A Volkswagen 5WA 505 465 A</p>		<p>Audi 5Q0 505 465 C Audi (FAW) 5Q0 505 465 C CUPRA 5Q0505465C Seat 5Q0 505 465 C Skoda 5Q0 505 465 A Skoda 5WA 505 465 A Volkswagen 5Q0 505 465 C</p>	



**Application info**

Audi A1 I (8X\_) (05/10-10/18)  
 Audi A3 IV (8Y\_) (11/19--)  
 Audi Q3 II (F3\_) (07/18--)  
 CUPRA ATECA (KH7\_KHP) (09/18--)  
 Seat Leon III (5F\_) (09/12--)  
 Skoda Karoq (07/17--)  
 Skoda Octavia III (5E\_) (11/12--)  
 Skoda Superb III (3V\_) (03/15--)  
 Volkswagen Golf VII (5G1,BA5) (08/12--)  
 Volkswagen Jetta VII (BU3) (12/17--)  
 Volkswagen T-Roc (A11) (07/17--)  
 Volkswagen Tiguan II (AD1, BW2) (01/16--)

Audi A3 III (8V\_) (04/12--)  
 Audi Q2 (06/16--)  
 Audi TT III (8S\_) (07/14--)  
 Seat Ateca (04/16--)  
 Seat Tarraco (09/18--)  
 Skoda Kodiaq I (10/16--)  
 Skoda Octavia IV (NX\_) (11/19--)  
 Volkswagen Arteon (03/17--)  
 Volkswagen Golf VIII (CB1) (07/19--)  
 Volkswagen Passat (B8) (08/14--)  
 Volkswagen Taos (CL1, CQ1) (10/20--)  
 Volkswagen Touran II (5T1) (05/15--)

**Stabilizer link****116 060 0041/S****MSL0910****Notes**

Aluminium  
 Coupling Rod  
 Front Axle Left  
 Front Axle Right

Length [mm] 170  
 Required quantity 2  
 replacement in pairs recommended

**References**

Audi 4G0 411 317  
 Audi 4H0 411 317 A  
 Audi 4M0 411 317  
 Audi 7L0 411 317  
 Audi 8K0 411 317 D  
 Audi (FAW) 4H0 411 317 C  
 Audi (FAW) 8K0 411 317 D  
 Audi (FAW) L8KD 411 317  
 Porsche 4M0 411 317  
 Volkswagen 4M0 411 317 J

Audi 4G0 411 317 A  
 Audi 4H0 411 317 C  
 Audi 4M0 411 317 J  
 Audi 8K0 411 317 C  
 Audi 8K0 411 317 E  
 Audi (FAW) 4M0 411 317  
 Audi (FAW) 8K0 411 317 E  
 Porsche 4G0 411 317 A  
 Volkswagen 4M0 411 317  
 Volkswagen (SVW) 4M0 411 317

**Application info**

Audi A4 IV (8K\_) (08/07-05/16)  
 Audi A6 IV (4G2, 4G5, C7) (11/10-09/18)  
 Audi A8 III (4H\_) (11/09-01/18)  
 Porsche Macan (95B) (02/14--)

Audi A5 I (8F\_ , 8T\_) (06/07-01/17)  
 Audi A7 I Sportback (4G\_) (07/10-05/18)  
 Audi Q5 I (8R\_) (11/08-12/17)

**Stabilizer link**

116 060 0045

MSL0751

**Notes**

Coupling Rod  
 Front Axle Left  
 Front Axle Right  
 with spanner attachment

Length [mm]

270

Required quantity

2

Thread Size 1

M10x1,5

Thread Size 2

M10x1,5

replacement in pairs recommended

**References**

The references of this product can be found at [www.meyle.com](http://www.meyle.com)

**Application info**

Audi A1 I (8X\_) (05/10-10/18)

Audi A2 (8Z0) (02/00-08/05)

Seat Ibiza III / Cordoba II (6L\_) (02/02-11/09)

Seat Ibiza V (KJ1) (01/17--)

Seat Toledo IV (KG3) (07/12-04/19)

Skoda Fabia I (6Y\_) (08/99-03/08)

Skoda Fabia III (NJ\_) (08/14--)

Skoda Kamiq (07/19--)

Skoda Roomster (03/06-05/15)

Volkswagen Fox/Lupo (Z51) (08/03--)

Volkswagen Polo (6R\_) (03/09--)

Volkswagen Polo (AW1) (06/17--)

Volkswagen Polo Vivo (6R1, 6RS) (07/17--)

Volkswagen UP (08/11--)

Audi A1 II (GB\_) (07/18--)

Seat Arona (KJ7) (07/17--)

Seat Ibiza IV (6J\_, 6P\_) (03/08-12/18)

Seat Mii (10/11--)

Skoda Citigo (10/11--)

Skoda Fabia II (54\_) (12/06-12/14)

Skoda Fabia IV (PJ3) (06/21--)

Skoda Rapid II (N\_) (07/12-12/19)

Skoda Scala (02/19--)

Volkswagen Nivus / Taigo (11/21--)

Volkswagen Polo (9N\_) (10/01--)

Volkswagen Polo Vivo (6S1, 6S3) (02/10-09/17)

Volkswagen T-Cross (12/18--)

**Stabilizer link**

116 060 0046

MSL0752

**Notes**

Coupling Rod  
 Front Axle Left  
 Front Axle Right  
 with spanner attachment

Length [mm]

335

Required quantity

2

Thread Size 1

M12x1,5

Thread Size 2

M12x1,5

replacement in pairs recommended



**References**

Audi 1K0 411 315 B  
Audi 1K0 411 315 E  
Audi 1K0 411 315 K  
Audi 1K0 411 315 R  
Audi 5Q0 411 315 B  
Audi (FAW) 1K0 411 315 K  
Audi (FAW) 5Q0 411 315 B  
CUPRA 1K0411315D  
CUPRA 1K0411315K  
CUPRA 1K0411315R  
Seat 1K0 411 315 D  
Seat 1K0 411 315 K  
Seat 1K0 411 315 R  
Seat 5Q0 411 315 B  
Skoda 1K0 411 315 J  
Skoda 1K0 411 315 P  
Skoda 5Q0 411 315 A  
Skoda (SVW) 1K0 411 315 J  
Skoda (SVW) 1K0 411 315 P  
Volkswagen 1K0 411 315 B  
Volkswagen 1K0 411 315 E  
Volkswagen 1K0 411 315 K  
Volkswagen 1K0 411 315 R  
Volkswagen 5Q0 411 315 B  
Volkswagen (FAW) 1K0 411 315 R  
Volkswagen (FAW) 1KD 411 315 A  
Volkswagen (SVW) 1K0 411 315 D  
Volkswagen (SVW) 1K0 411 315 K  
Volkswagen (SVW) 5QD 411 315 A  
Audi 1K0 411 315 D  
Audi 1K0 411 315 J  
Audi 1K0 411 315 P  
Audi 5Q0 411 315 A  
Audi 5QM 411 315  
Audi (FAW) 1K0 411 315 P  
CUPRA 1K0411315B  
CUPRA 1K0411315J  
CUPRA 1K0411315P  
CUPRA 5Q0411315A  
Seat 1K0 411 315 J  
Seat 1K0 411 315 P  
Seat 5Q0 411 315 A  
Skoda 1K0 411 315 D  
Skoda 1K0 411 315 K  
Skoda 1K0 411 315 R  
Skoda 5Q0 411 315 B  
Skoda (SVW) 1K0 411 315 K  
Skoda (SVW) 1K0 411 315 R  
Volkswagen 1K0 411 315 D  
Volkswagen 1K0 411 315 J  
Volkswagen 1K0 411 315 P  
Volkswagen 5Q0 411 315 A  
Volkswagen 5QM 411 315  
Volkswagen (FAW) 1KD 411 315  
Volkswagen (FAW) L1KD 411 315  
Volkswagen (SVW) 1K0 411 315 J  
Volkswagen (SVW) 1K0 411 315 R

**Application info**

Audi A3 II (8P_) (05/03-12/15)	Audi A3 III (8V_) (04/12--)
Audi A3 IV (8Y_) (11/19--)	Audi Q2 (06/16--)
Audi Q3 I (8U_) (06/11-12/18)	Audi Q3 II (F3_) (07/18--)
Audi TT II (8J_) (07/06-01/15)	Audi TT III (8S_) (07/14--)
CUPRA ATECA (KH7_KHP) (09/18--)	CUPRA FORMENTOR (KM_) (07/20--)
CUPRA LEON (KL_) (10/20--)	Seat Alhambra II (710) (06/10--)
Seat Ateca (04/16--)	Seat Leon II / Toledo III / Altea (1P_ ,5P_) (03/04--)
Seat Leon III (5F_) (09/12--)	Seat Leon IV (KL_) (11/19--)
Seat Tarraco (09/18--)	Skoda Karoq (07/17--)
Skoda Kodiaq I (10/16--)	Skoda Octavia II (1Z_) (02/04-06/13)
Skoda Octavia III (5E_) (11/12--)	Skoda Octavia IV (NX_) (11/19--)
Skoda Superb II (3T) (03/08-05/15)	Skoda Superb III (3V_) (03/15--)
Skoda Yeti (5L) (05/09-12/17)	Volkswagen Arteon (03/17--)
Volkswagen Atlas (12/16--)	Volkswagen Beetle (5C1) (04/11-07/19)
Volkswagen CC (11/11-12/16)	Volkswagen Caddy III (2KA, 2KB) (03/04-05/15)
Volkswagen Caddy IV (SA_) (05/15--)	Volkswagen Caddy V (SBB, SBJ) (09/20--)
Volkswagen Eos (03/06-08/15)	Volkswagen Golf V (1K1, 1K5, 5M1) (10/03-08/14)
Volkswagen Golf VI (5K1, 517, AJ5) (10/08-05/16)	Volkswagen Golf VII (5G1,BA5) (08/12--)
Volkswagen Golf VIII (CB1) (07/19--)	Volkswagen Jetta III (1K2) (09/04-12/13)
Volkswagen Jetta IV (162) (01/08--)	Volkswagen Jetta VII (BU3 ) (12/17--)
Volkswagen Passat (362, 365) (08/10-12/15)	Volkswagen Passat (3C_) (03/05-01/12)
Volkswagen Passat (A32) (01/11--)	Volkswagen Passat (B8) (08/14--)
Volkswagen Scirocco III (137) (05/08-11/17)	Volkswagen Sharan (7N) (05/10--)
Volkswagen T-Roc (A11) (07/17--)	Volkswagen Taos (CL1, CQ1) (10/20--)
Volkswagen Tiguan I (5N ) (09/07-07/18)	Volkswagen Tiguan II (AD1, BW2 ) (01/16--)
Volkswagen Touran I ( 1T1/2/3) (02/03-05/15)	Volkswagen Touran II (5T1 ) (05/15--)

**Stabilizer link****116 060 0047****MSL0753****Notes**

Coupling Rod  
 Front Axle Left  
 Front Axle Right  
 with spanner attachment

Length [mm]	260
Required quantity	2
Thread Size 1	M12x1,75
Thread Size 2	M12x1,75
replacement in pairs recommended	



**References**

Volkswagen 7H0 411 317	Volkswagen 7H0 411 317 A
Volkswagen 7H5 411 317	Volkswagen 7H5 411 317 A
Volkswagen 7H5 411 317 B	Volkswagen 7H5 411 317 D
Volkswagen 7H5 411 317 E	

**Application info**

Volkswagen Transporter V (04/03-08/15)	Volkswagen Transporter VI (04/15--)
--	-------------------------------------

**Stabilizer link**

**116 060 0050 MSL0755**

**Notes**

	Coupling Rod Front Axle Right with spanner attachment
Length [mm]	336
Paired article number	116 060 0051   MSL0756
Required quantity	1
Thread Size 1	M12x1,5
Thread Size 2	M12x1,5
replacement in pairs recommended	



**References**

Audi 1J0 411 316 D	Seat 1J0 411 316 D
Skoda 1J0 411 316 D	Volkswagen 1J0 411 316 D

**Application info**

Audi A3 I (8L_) (09/96-09/06)	Audi TT I (8N_) (10/98-12/06)
Seat Leon I / Toledo II (1M_) (10/98-06/06)	Skoda Octavia I (1U_) (09/96-12/10)
Volkswagen Bora (1J2, 1J6) (10/98-12/13)	Volkswagen Golf IV (1J1, 1J5) (08/97-06/14)
Volkswagen New Beetle (1Y7, 9C1, 1C1) (01/98-12/11)	

**Stabilizer link**

**116 060 0051 MSL0756**

**Notes**

	Coupling Rod Front Axle Left with spanner attachment
Length [mm]	336
Paired article number	116 060 0050   MSL0755
Required quantity	1
Thread Size 1	M12x1,5
Thread Size 2	M12x1,5
replacement in pairs recommended	



**References**

Audi 1J0 411 315 D

Skoda 1J0 411 315 D

Seat 1J0 411 315 D

Volkswagen 1J0 411 315 D

**Application info**

Audi A3 I (8L\_) (09/96-09/06)

Seat Leon I / Toledo II (1M\_) (10/98-06/06)

Volkswagen Bora (1J2, 1J6) (10/98-12/13)

Volkswagen New Beetle (1Y7, 9C1, 1C1) (01/98-12/11)

Audi TT I (8N\_) (10/98-12/06)

Skoda Octavia I (1U\_) (09/96-12/10)

Volkswagen Golf IV (1J1, 1J5) (08/97-06/14)

**Stabilizer link****116 060 0063/HD****MSL0922HD****Notes**

Carbon Neutral  
Coupling Rod  
Front Axle Left  
Front Axle Right  
with spanner attachment

Length [mm]

335

Required quantity

2

Thread Size 1

M12x1,5

Thread Size 2

M12x1,5

reinforced version

replacement in pairs recommended



**References**

Audi 1K0 411 315 B	Audi 1K0 411 315 D
Audi 1K0 411 315 E	Audi 1K0 411 315 J
Audi 1K0 411 315 K	Audi 1K0 411 315 P
Audi 1K0 411 315 R	Audi 5Q0 411 315 A
Audi 5Q0 411 315 B	Audi 5Q0 411 315 C
Audi 5Q0 411 315 D	Audi 5QM 411 315
Audi (FAW) 1K0 411 315 K	Audi (FAW) 1K0 411 315 P
Audi (FAW) 5Q0 411 315 B	CUPRA 1K0411315B
CUPRA 1K0411315D	CUPRA 1K0411315J
CUPRA 1K0411315K	CUPRA 1K0411315P
CUPRA 1K0411315R	CUPRA 5Q0 411 315 D
CUPRA 5Q0411315A	Seat 1K0 411 315 D
Seat 1K0 411 315 J	Seat 1K0 411 315 K
Seat 1K0 411 315 P	Seat 1K0 411 315 R
Seat 5Q0 411 315 A	Seat 5Q0 411 315 B
Seat 5Q0 411 315 C	Seat 5Q0 411 315 D
Skoda 1K0 411 315 D	Skoda 1K0 411 315 J
Skoda 1K0 411 315 K	Skoda 1K0 411 315 P
Skoda 1K0 411 315 R	Skoda 5Q0 411 315 A
Skoda 5Q0 411 315 B	Skoda 5Q0 411 315 C
Skoda 5Q0 411 315 D	Skoda (SVW) 1K0 411 315 J
Skoda (SVW) 1K0 411 315 K	Skoda (SVW) 1K0 411 315 P
Skoda (SVW) 1K0 411 315 R	Volkswagen 1K0 411 315 B
Volkswagen 1K0 411 315 D	Volkswagen 1K0 411 315 E
Volkswagen 1K0 411 315 J	Volkswagen 1K0 411 315 K
Volkswagen 1K0 411 315 P	Volkswagen 1K0 411 315 R
Volkswagen 3QF 411 315 A	Volkswagen 5Q0 411 315 A
Volkswagen 5Q0 411 315 B	Volkswagen 5Q0 411 315 D
Volkswagen 5QM 411 315	Volkswagen (FAW) 1K0 411 315 R
Volkswagen (FAW) 1KD 411 315	Volkswagen (FAW) 1KD 411 315 A
Volkswagen (FAW) L1KD 411 315	Volkswagen (SVW) 1K0 411 315 D
Volkswagen (SVW) 1K0 411 315 J	Volkswagen (SVW) 1K0 411 315 K
Volkswagen (SVW) 1K0 411 315 R	Volkswagen (SVW) 3QF 411 315 A
Volkswagen (SVW) 5QD 411 315 A	

**Application info**

Audi A3 II (8P_) (05/03-12/15)	Audi A3 III (8V_) (04/12--)
Audi A3 IV (8Y_) (11/19--)	Audi Q2 (06/16--)
Audi Q3 I (8U_) (06/11-12/18)	Audi Q3 II (F3_) (07/18--)
Audi TT II (8J_) (07/06-01/15)	Audi TT III (8S_) (07/14--)
CUPRA ATECA (KH7_KHP) (09/18--)	CUPRA FORMENTOR (KM_) (07/20--)
CUPRA LEON (KL_) (10/20--)	Seat Alhambra II (710) (06/10--)
Seat Ateca (04/16--)	Seat Leon II / Toledo III / Altea (1P_ ,5P_) (03/04--)
Seat Leon III (5F_) (09/12--)	Seat Leon IV (KL_) (11/19--)
Seat Tarraco (09/18--)	Skoda Karoq (07/17--)
Skoda Kodiaq I (10/16--)	Skoda Octavia II (1Z_) (02/04-06/13)
Skoda Octavia III (5E_) (11/12--)	Skoda Octavia IV (NX_) (11/19--)
Skoda Superb II (3T) (03/08-05/15)	Skoda Superb III (3V_) (03/15--)
Skoda Yeti (5L) (05/09-12/17)	Volkswagen Arteon (03/17--)
Volkswagen Atlas (12/16--)	Volkswagen Beetle (5C1) (04/11-07/19)
Volkswagen CC (11/11-12/16)	Volkswagen Caddy III (2KA, 2KB) (03/04-05/15)
Volkswagen Caddy IV (SA_) (05/15--)	Volkswagen Caddy V (SBB, SBJ) (09/20--)
Volkswagen Eos (03/06-08/15)	Volkswagen Golf V (1K1, 1K5, 5M1) (10/03-08/14)
Volkswagen Golf VI (5K1, 517, AJ5) (10/08-05/16)	Volkswagen Golf VII (5G1,BA5) (08/12--)
Volkswagen Golf VIII (CB1) (07/19--)	Volkswagen Jetta City (09/06-12/09)
Volkswagen Jetta III (1K2) (09/04-12/13)	Volkswagen Jetta IV (162) (01/08--)
Volkswagen Jetta VII (BU3) (12/17--)	Volkswagen Passat (362, 365) (08/10-12/15)
Volkswagen Passat (3C_) (03/05-01/12)	Volkswagen Passat (A32) (01/11--)
Volkswagen Passat (B8) (08/14--)	Volkswagen Scirocco III (137) (05/08-11/17)
Volkswagen Sharan (7N) (05/10--)	Volkswagen T-Roc (A11) (07/17--)
Volkswagen Taos (CL1, CQ1) (10/20--)	Volkswagen Tiguan I (5N) (09/07-07/18)
Volkswagen Tiguan II (AD1, BW2) (01/16--)	Volkswagen Touran I (1T1/2/3) (02/03-05/15)
Volkswagen Touran II (5T1) (05/15--)	

**Stabilizer link****116 060 0064/HD****MSL0956HD****Notes**

	Carbon Neutral
	Coupling Rod
	Front Axle Right
Length [mm]	380
Paired article number	116 060 0065/HD   MSL0957HD
Required quantity	1
Thread Size 1	M14x1,5
Thread Size 2	M14x1,5
reinforced version	
replacement in pairs recommended	





**References**

MAN 65.43718.0002  
 MAN 65.43718.0008  
 Volkswagen 2N0 411 318 A

MAN 65.43718.0007  
 Volkswagen 2N0 411 318  
 Volkswagen 2N0 411 318 B

**Application info**

MAN TGE (11/16--)

Volkswagen Crafter II (SY\_) (09/16--)

**Stabilizer link****116 060 0065/HD****MSL0957HD****Notes**

Carbon Neutral  
 Coupling Rod  
 Front Axle Left

Length [mm] 380  
 Paired article number 116 060 0064/HD | MSL0956HD  
 Required quantity 1  
 Thread Size 1 M14x1,5  
 Thread Size 2 M14x1,5

reinforced version  
 replacement in pairs recommended

**References**

MAN 65.43718.0001  
 Volkswagen 2N0 411 317 B  
 Volkswagen 2N0 411 317 D

MAN 65.43718.0009  
 Volkswagen 2N0 411 317 C

**Application info**

MAN TGE (11/16--)

Volkswagen Crafter II (SY\_) (09/16--)

**Stabilizer link****116 060 0066****MSL0977****Notes**

Coupling Rod  
 Rear Axle Left  
 Rear Axle Right

Length [mm] 180  
 Required quantity 2  
 Thread Size 1 M12x1,5

replacement in pairs recommended

**References**

MAN 2N0505465  
 Volkswagen 2N0 505 465

MAN 65.43718.0004

**Application info**

MAN TGE (11/16--)

Volkswagen Crafter II (SY\_) (09/16--)

**Stabilizer link**

116 060 0067

MSL0978

**Notes**

Coupling Rod  
Rear Axle Left  
Rear Axle Right

Length [mm]

135

Required quantity

2

replacement in pairs recommended



**References**

MAN 2N0505465A

MAN 65.43718.0006

Volkswagen 2N0 505 465 A

**Application info**

MAN TGE (11/16--)

Volkswagen Crafter II (SY\_) (09/16--)

**Stabilizer link**

116 060 0068

MSL0979

**Notes**

Coupling Rod  
Rear Axle Left  
Rear Axle Right

Inner Diameter [mm]

12

Length [mm]

185

Pipe Diameter [mm]

10

Required quantity

2

Thread Size 1

M14x1,5

replacement in pairs recommended



**References**

MAN 2N0505465B



MAN 65.43718.0005

Volkswagen 2N0 505 465 B

**Application info**

MAN TGE (11/16--)

Volkswagen Crafter II (SY\_) (09/16--)

Stabilizer link		116 060 0074/HD	MSL1190HD
<b>Notes</b>			
	Carbon Neutral Coupling Rod Rear Axle Right		
Length [mm]	174.5		
Paired article number	116 060 0075/HD   MSL1191HD		
Required quantity	1		
Thread Size	M10x1,5		
replacement in pairs recommended			
<b>References</b>			
Audi 1EA 505 466		CUPRA 1EA 505 466	
Skoda 1EA 505 466		Volkswagen 1EA 505 466	
<b>Application info</b>			
Audi Q4 (F4_) (03/21--)		CUPRA BORN (K11) (08/21--)	
Skoda Enyaq iV (5A_) (10/20--)		Volkswagen ID.3 (E11_) (11/19--)	
Volkswagen ID.4 (E21) (05/20--)		Volkswagen ID.5 (E39) (07/21--)	
Volkswagen ID.7 (06/23--)			
Stabilizer link		116 060 0075/HD	MSL1191HD
<b>Notes</b>			
	Carbon Neutral Coupling Rod Rear Axle Left		
Length [mm]	174.5		
Paired article number	116 060 0074/HD   MSL1190HD		
Required quantity	1		
Thread Size	M10x1,5		
replacement in pairs recommended			
<b>References</b>			
Audi 1EA 505 465		CUPRA 1EA 505 465	
Skoda 1EA 505 465		Volkswagen 1EA 505 465	
<b>Application info</b>			
Audi Q4 (F4_) (03/21--)		CUPRA BORN (K11) (08/21--)	
Skoda Enyaq iV (5A_) (10/20--)		Volkswagen ID.3 (E11_) (11/19--)	
Volkswagen ID.4 (E21) (05/20--)		Volkswagen ID.5 (E39) (07/21--)	
Volkswagen ID.7 (06/23--)			

**Stabilizer link**

116 060 0079/S

MSL1202

**Notes**

Aluminium  
Coupling Rod  
Front Axle Left  
Front Axle Right

Inner Diameter 1 [mm] 10.1  
Inner Diameter 2 [mm] 10.1  
Length [mm] 170  
Required quantity 2  
replacement in pairs recommended



**References**

Audi 4G0 411 317	Audi 4G0 411 317 A
Audi 4H0 411 317 A	Audi 4H0 411 317 C
Audi 4M0 411 317	Audi 4M0 411 317 J
Audi 8K0 411 317 C	Audi 8K0 411 317 D
Audi 8K0 411 317 E	Audi (FAW) 4H0 411 317 C
Audi (FAW) 4M0 411 317	Audi (FAW) 8K0 411 317 D
Audi (FAW) 8K0 411 317 E	Audi (FAW) L8KD 411 317
Porsche 4G0 411 317 A	Porsche 4M0 411 317
Volkswagen 4M0 411 317	Volkswagen 4M0 411 317 J
Volkswagen (SVW) 4M0 411 317	

**Application info**

Audi A4 V (8W_) (05/15--)	Audi A5 II (F5_) (06/16--)
Audi A6 V (C8, 4A2) (02/18--)	Audi A7 II Sportback (4K_) (10/17--)
Audi A8 IV (4N_) (06/17--)	Audi E-TRON (GE_) (09/18--)
Audi Q5 II (FY_) (05/16--)	Audi Q7 II (4M_) (01/15--)
Audi Q8 (4MN) (02/18--)	Audi Q8 E-TRON (11/22--)
Porsche Cayenne III (9Y_) (05/17--)	Volkswagen Touareg III (CR7) (11/17--)



Stabilizer link		116 060 8296/HD	MSL0149HD
<b>Notes</b>  Carbon Neutral Coupling Rod Rear Axle Right with spanner attachment  Inner Diameter [mm] 10 Length [mm] 227 Paired article number 116 060 8295/HD   MSL0148HD Required quantity 1 Thread Size 1 M10x1,5 reinforced version replacement in pairs recommended			
<b>References</b> Audi 8A0 505 466 C Audi 8D0 505 466			
<b>Application info</b> Audi 80 (8C, 8G7, B4) (05/91-08/00) Audi A4 I (8D_) (11/94-12/02)			
Stabilizer link		15-16 060 0001/HD	MSL0151HD
<b>Notes</b>  Carbon Neutral Coupling Rod  Length [mm] 125 Required quantity 2 Thread Size 1 M10x1,5 Thread Size 2 M10x1,5 reinforced version replacement in pairs recommended			
<b>References</b> Alfa Romeo 46841498 Alfa Romeo 46843389 Alfa Romeo 60625029 Honda 52320-SED-003			
<b>Application info</b> Alfa Romeo 147 (10/00-12/10) Alfa Romeo 156 (02/97-05/06) Alfa Romeo GT (937) (11/03-09/10) Honda Accord VIII (09/02--)			

**Stabilizer link**

15-16 060 0002/HD

MSL0152HD

**Notes**

Carbon Neutral  
Coupling Rod  
Front Axle Left  
Front Axle Right  
with spanner attachment

Length [mm]

145

Required quantity

2

Thread Size 1

M10x1,5

Thread Size 2

M10x1,5

reinforced version

replacement in pairs recommended

**References**

Alfa Romeo 60630757

**Application info**

Alfa Romeo 166 (09/98-06/07)

**Stabilizer link**

15-16 060 0007/HD

MSL0153HD

**Notes**

Carbon Neutral  
Coupling Rod  
Rear Axle Left  
Rear Axle Right  
with spanner attachment

Length [mm]

180

Required quantity

2

Thread Size 1

M10x1,25

Thread Size 2

M10x1,25

reinforced version

replacement in pairs recommended

**References**

Alfa Romeo 60613575



Alfa Romeo 60699021

**Application info**



Alfa Romeo 147 (10/00-12/10)





Alfa Romeo 156 (02/97-05/06)





Alfa Romeo GT (937) (11/03-09/10)



Stabilizer link		15-16 060 0010/HD	MSL0156HD
<b>Notes</b>  Carbon Neutral Coupling Rod Front Axle Left  Length [mm] 101.5 Paired article number 15-16 060 0011/HD   MSL0157HD Required quantity 1 Thread Size 1 M12X1,5 Thread Size 2 M12X1,5 reinforced version replacement in pairs recommended			
<b>References</b> Alfa Romeo 50704361 Alfa Romeo 50706990 Alfa Romeo 51795454			
<b>Application info</b> Alfa Romeo 159 (06/05-12/12) Alfa Romeo Brera (01/06-05/11) Alfa Romeo Spider (939) (03/06-03/11)			
Stabilizer link		15-16 060 0011/HD	MSL0157HD
<b>Notes</b>  Carbon Neutral Coupling Rod Front Axle Right  Length [mm] 101.5 Paired article number 15-16 060 0010/HD   MSL0156HD Required quantity 1 Thread Size 1 M12X1,5 Thread Size 2 M12X1,5 reinforced version replacement in pairs recommended			
<b>References</b> Alfa Romeo 50704362 Alfa Romeo 50706991 Alfa Romeo 51795455			
<b>Application info</b> Alfa Romeo 159 (06/05-12/12) Alfa Romeo Brera (01/06-05/11) Alfa Romeo Spider (939) (03/06-03/11)			



Stabilizer link		15-16 060 0012/HD	MSL0158HD
<b>Notes</b>  Carbon Neutral Coupling Rod Rear Axle Left  Length [mm] 116 Paired article number 15-16 060 0013/HD   MSL0159HD Required quantity 1 Thread Size 1 M12X1,5 Thread Size 2 M12X1,5 reinforced version replacement in pairs recommended			
<b>References</b> Alfa Romeo 50704680 Alfa Romeo 50705311 Alfa Romeo 50705702 Alfa Romeo 50706004 Alfa Romeo 51795703 Alfa Romeo 51795705			
<b>Application info</b> Alfa Romeo 159 (06/05-12/12) Alfa Romeo Brera (01/06-05/11) Alfa Romeo Spider (939) (03/06-03/11)			
Stabilizer link		15-16 060 0013/HD	MSL0159HD
<b>Notes</b>  Carbon Neutral Coupling Rod Rear Axle Right  Length [mm] 116 Paired article number 15-16 060 0012/HD   MSL0158HD Required quantity 1 Thread Size 1 M12X1,5 Thread Size 2 M12X1,5 reinforced version replacement in pairs recommended			
<b>References</b> Alfa Romeo 50706595 Alfa Romeo 50706598 Alfa Romeo 51795704 Alfa Romeo 51795706 Fiat 50706598			
<b>Application info</b> Alfa Romeo 159 (06/05-12/12) Alfa Romeo Brera (01/06-05/11) Alfa Romeo Spider (939) (03/06-03/11) Fiat Stilo (10/01-11/10)			

Stabilizer link		15-16 060 0018	MSL0764
<b>Notes</b>  Coupling Rod Rear Axle Left Rear Axle Right with spanner attachment  Length [mm] 180 Required quantity 2 Thread Size 1 M10x1,25 Thread Size 2 M10x1,25 replacement in pairs recommended		 	
<b>References</b> Alfa Romeo 60613575		Alfa Romeo 60699021	
<b>Application info</b> Alfa Romeo 147 (10/00-12/10) Alfa Romeo GT (937) (11/03-09/10)		Alfa Romeo 156 (02/97-05/06)	
Stabilizer link		15-16 060 0019/HD	MSL1099HD
<b>Notes</b>  Carbon Neutral Coupling Rod Rear Axle Left Rear Axle Right  Length [mm] 109 Required quantity 2 Thread Size 1 M12x1,5 Thread Size 2 M12x1,5 reinforced version replacement in pairs recommended		 	
<b>References</b> Alfa Romeo 50543807		Alfa Romeo 50548354	
<b>Application info</b> Alfa Romeo Giulia (952) (10/15--) Alfa Romeo Stelvio (949) (12/16--) 			

Stabilizer link		15-16 060 0020/HD	MSL1104HD		
<b>Notes</b>					
	Carbon Neutral				
	Coupling Rod				
	Front Axle Left				
	Front Axle Right				
Length [mm]	183				
Required quantity	2				
Thread Size 1	12x1,5				
Thread Size 2	12x1,5				
reinforced version					
replacement in pairs recommended					
<b>References</b>					
Alfa Romeo 50543786					
<b>Application info</b>					
Alfa Romeo Giulia (952) (10/15--)		Alfa Romeo Stelvio (949) (12/16--)			
Stabilizer link		15-16 060 0021/HD	MSL1139HD		
<b>Notes</b>					
	Carbon Neutral				
	Coupling Rod				
	Front Axle Left				
	Front Axle Right				
Length [mm]	183				
Required quantity	2				
Thread Size 1	M12x1,5				
Thread Size 2	M12x1,5				
replacement in pairs recommended					
<b>References</b>					
Alfa Romeo 50543482					
<b>Application info</b>					
Alfa Romeo Giulia (952) (10/15--)					

Stabilizer link		16-16 060 0000/HD	MSL0161HD
<b>Notes</b>  Carbon Neutral Coupling Rod Front Axle Left with spanner attachment  Length [mm] 255 Paired article number 16-16 060 0001/HD   MSL0162HD Required quantity 1 Thread Size 1 M10x1,5 Thread Size 2 M10x1,5 reinforced version replacement in pairs recommended			
<b>References</b> Renault 8200040618 Renault 8200714446			
<b>Application info</b> Renault Twingo I (03/93-10/12)			
Stabilizer link		16-16 060 0001/HD	MSL0162HD
<b>Notes</b>  Carbon Neutral Coupling Rod Front Axle Right with spanner attachment  Length [mm] 255 Paired article number 16-16 060 0000/HD   MSL0161HD Required quantity 1 Thread Size 1 M10x1,5 Thread Size 2 M10x1,5 reinforced version replacement in pairs recommended			
<b>References</b> Renault 8200050191 Renault 8200714448			
<b>Application info</b> Renault Twingo I (03/93-10/12)			

## Stabilizer link

16-16 060 0003/HD

MSL0163HD

## Notes

Carbon Neutral  
Coupling Rod  
Front Axle Left  
Front Axle Right  
with spanner attachment

Length [mm] 280  
Required quantity 2  
Thread Size 1 M10x1,5  
Thread Size 2 M10x1,5  
reinforced version  
replacement in pairs recommended







## References

Fiat 6000618859	Fiat 6000640472
GENERAL MOTORS 91167000	GENERAL MOTORS 93450030
GENERAL MOTORS 93858917	Nissan 54616-00Q0A
Nissan 54616-00Q0J	Nissan 54616-00Q1C
Nissan 54616-00Q1F	Nissan 54616-00QAC
Opel 44 07 573	Opel 44 08 904
Opel 44 17 973	Renault 546180393R
Renault 546181944R	Renault 7711160426
Renault 8200002870	Renault 8200661217
Vauxhall 44 08 904	Vauxhall 44 17 973

## Application info

Fiat Talento (06/16--)	Nissan NV300 (09/16--)
Nissan Primastar I (X83) (03/01--)	Nissan Primastar II (X82) (11/21--)
Opel Vivaro A (08/01--)	Opel Vivaro B (06/14--)
Renault Clio III / Modus (09/04--)	Renault Espace IV (11/02--)
Renault Laguna II (03/01-12/07)	Renault Trafic II (03/01--)
Renault Trafic III (05/14--)	Renault Vel Satis (06/02--)
Vauxhall Vivaro A (08/01-07/14)	Vauxhall Vivaro B (05/14--)

Stabilizer link		16-16 060 0004/HD	MSL0164HD
<b>Notes</b>  Carbon Neutral Coupling Rod Front Axle Left Front Axle Right with spanner attachment  Length [mm] 287 Required quantity 2 Thread Size 1 M10x1,5 Thread Size 2 M10x1,5 reinforced version replacement in pairs recommended		 	
<b>References</b> Mercedes-Benz 415 320 01 89 Mercedes-Benz A 415 320 01 89 Renault 546181925R Renault 8200166159 Renault 8200669065			
<b>Application info</b> Mercedes-Benz BM 415 (Citan) (11/12--) Renault Mégane II (07/01--) Renault Kangoo II (02/08--) Renault Scénic II (06/03-07/10)			
Stabilizer link		16-16 060 0006/HD	MSL0165HD
<b>Notes</b>  Carbon Neutral Coupling Rod Front Axle Left Front Axle Right with spanner attachment  Length [mm] 257 Required quantity 2 Thread Size 1 M10x1,5 Thread Size 2 M10x1,5 reinforced version replacement in pairs recommended		 	
<b>References</b> Renault 7700437136			
<b>Application info</b> Renault Kangoo I (08/97--) Renault Mégane I / Scénic I (08/95-07/10)			

**Stabilizer link**

16-16 060 0007/HD

MSL0166HD

**Notes**

Carbon Neutral  
Coupling Rod  
Rear Axle Left  
Rear Axle Right  
with spanner attachment

Length [mm] 154  
Required quantity 2  
Thread Size 1 M10X1,5  
Thread Size 2 M10X1,5  
reinforced version  
replacement in pairs recommended

**References**

Renault 8200001857

Renault 8200619922

**Application info**

Renault Vel Satis (06/02--)

**Stabilizer link**

16-16 060 0008/HD

MSL0167HD

**Notes**

Carbon Neutral  
Coupling Rod  
Front Axle Left  
Front Axle Right  
with spanner attachment

Length [mm] 275  
Required quantity 2  
Thread Size 1 M10x1,5  
Thread Size 2 M10x1,5  
reinforced version  
replacement in pairs recommended

**References**

Mercedes-Benz 420 320 01 00

Mercedes-Benz A 420 320 01 00

Renault 546180002R

Renault 546182227R

Renault 546185678R

Renault 546187005R

Renault 546188897R

**Application info**

Renault Espace V (02/15--)  
 Renault Megane IV (11/15--)  
 Renault Scénic III (12/08--)

Renault Megane III (11/08--)  
 Renault Scenic / Grand Scenic IV (09/16--)  
 Renault Talisman (06/15--)

**Stabilizer link****16-16 060 0008****MSL0167****Notes**

Coupling Rod  
 Front Axle Left  
 Front Axle Right

Length [mm] 275  
 Required quantity 2  
 Thread Size 1 M10x1,5  
 Thread Size 2 M10x1,5  
 replacement in pairs recommended

**References**

Mercedes-Benz 420 320 01 00  
 Renault 546180002R  
 Renault 546185678R  
 Renault 546188897R

Mercedes-Benz A 420 320 01 00  
 Renault 546182227R  
 Renault 546187005R

**Application info**

Renault Espace V (02/15--)  
 Renault Megane IV (11/15--)  
 Renault Scénic III (12/08--)

Renault Megane III (11/08--)  
 Renault Scenic / Grand Scenic IV (09/16--)  
 Renault Talisman (06/15--)

**Stabilizer link****16-16 060 0009****MSL0168****Notes**

Coupling Rod  
 Front Axle Left  
 Front Axle Right

Length [mm] 73  
 Required quantity 2  
 Thread Size M8x1,25  
 replacement in pairs recommended

**References**

Renault 8200891487



**Application info**

Renault Clio II / Thalia (02/98--)

Renault Twingo II / Wind (03/07--)

**Stabilizer link**

16-16 060 0010/HD

MSL0580HD

**Notes**

Carbon Neutral  
Coupling Rod  
Front Axle Left  
Front Axle Right  
with spanner attachment

Length [mm]

330

Required quantity

2

Thread Size 1

M10x1,5

Thread Size 2

M10x1,5

reinforced version

replacement in pairs recommended

**References**

GENERAL MOTORS 93197325

Nissan 54616-00Q0E

Opel 4419 291

Renault 546180004R

Vauxhall 93197325

**Application info**

Nissan Interstar II (X62B) (11/21--)

Nissan NV400 (11/11--)

Opel Movano B (05/10--)

Renault Master III (02/10--)

Vauxhall Movano Mk II (05/10--)

**Stabilizer link**

16-16 060 0011/HD

MSL0169HD

**Notes**

Carbon Neutral  
Coupling Rod  
Rear Axle Left  
Rear Axle Right  
not for dual tyres

Inner Diameter 1 [mm]

10

Length [mm]

105

Required quantity

2

Thread Size 1

M10x1,5

reinforced version

replacement in pairs recommended



**References**

GENERAL MOTORS 93197332  
Renault 551100019R

Opel 44 19 304  
Vauxhall 93197332

**Application info**

Opel Movano B (05/10--)  
Vauxhall Movano Mk II (05/10--)

Renault Master III (02/10--)

**Stabilizer link****16-16 060 0012****MSL0953****Notes**

Coupling Rod  
Rear Axle Left  
Rear Axle Right

Length [mm] 130  
Required quantity 2  
replacement in pairs recommended

**References**

Renault 7700436706

**Application info**

Renault Kangoo I (08/97--)

Renault Mégane I / Scénic I (08/95-07/10)

**Stabilizer link****16-16 060 0013****MSL0668****Notes**

Coupling Rod  
Front Axle Left  
Front Axle Right

Length [mm] 264  
Required quantity 2  
Thread Size 1 M10x1,5  
Thread Size 2 M10x1,5  
replacement in pairs recommended

**References**

Renault 546180009R

Renault 546182198R

**Application info**

Renault Fluence (02/10--)

**Stabilizer link****16-16 060 0015****MSL0765****Notes**

Coupling Rod  
 Front Axle Left  
 Front Axle Right  
 with spanner attachment

Length [mm]

280

Required quantity

2

Thread Size 1

M10x1,5

Thread Size 2

M10x1,5

replacement in pairs recommended

**References**

Fiat 6000618859

GENERAL MOTORS 91167000

GENERAL MOTORS 93858917

Nissan 54616-00Q0J

Nissan 54616-00Q1F

Opel 44 07 573

Opel 44 17 973

Renault 546181944R

Renault 8200002870

Vauxhall 44 08 904

Fiat 6000640472

GENERAL MOTORS 93450030

Nissan 54616-00Q0A

Nissan 54616-00Q1C

Nissan 54616-00QAC

Opel 44 08 904

Renault 546180393R

Renault 7711160426

Renault 8200661217

Vauxhall 44 17 973

**Application info**

Fiat Talento (06/16--)

Nissan Primastar I (X83) (03/01--)

Opel Vivaro A (08/01--)

Renault Clio III / Modus (09/04--)

Renault Laguna II (03/01-12/07)

Renault Trafic III (05/14--)

Vauxhall Vivaro A (08/01-07/14)

Nissan NV300 (09/16--)

Nissan Primastar II (X82) (11/21--)



Opel Vivaro B (06/14--)





Renault Espace IV (11/02--)

Renault Trafic II (03/01--)

Renault Vel Satis (06/02--)

Vauxhall Vivaro B (05/14--)

Stabilizer link		16-16 060 0016	MSL0766
<b>Notes</b>  Coupling Rod Front Axle Right with spanner attachment  Length [mm] 255 Paired article number 16-16 060 0017   MSL0767 Required quantity 1 Thread Size 1 M10x1,5 Thread Size 2 M10x1,5 replacement in pairs recommended			
<b>References</b> Renault 8200050191 Renault 8200714448			
<b>Application info</b> Renault Twingo I (03/93-10/12)			
Stabilizer link		16-16 060 0017	MSL0767
<b>Notes</b>  Coupling Rod Front Axle Left with spanner attachment  Length [mm] 255 Paired article number 16-16 060 0016   MSL0766 Required quantity 1 Thread Size 1 M10x1,5 Thread Size 2 M10x1,5 replacement in pairs recommended			
<b>References</b> Renault 8200040618 Renault 8200714446			
<b>Application info</b> Renault Twingo I (03/93-10/12)			

Stabilizer link		16-16 060 0018	MSL0768
<b>Notes</b>  Coupling Rod Front Axle Left Front Axle Right with spanner attachment  Length [mm] 287 Required quantity 2 Thread Size 1 M10x1,5 Thread Size 2 M10x1,5 replacement in pairs recommended		 	
<b>References</b> Mercedes-Benz 415 320 00 00 Mercedes-Benz 415 320 01 89 Mercedes-Benz A 415 320 00 00 Mercedes-Benz A 415 320 01 89 Renault 546181925R Renault 8200166159 Renault 8200669065			
<b>Application info</b> Mercedes-Benz BM 415 (Citan) (11/12--) Renault Mégane II (07/01--) Renault Kangoo II (02/08--) Renault Scénic II (06/03-07/10)			
Stabilizer link		16-16 060 0021/HD	MSL1100HD
<b>Notes</b>  Carbon Neutral Coupling Rod Front Axle Left Front Axle Right  Length [mm] 260 Required quantity 2 Thread Size 1 10x1,25 Thread Size 2 10x1,25 reinforced version replacement in pairs recommended		 	
<b>References</b> Nissan 54618-1427R Renault 546181427R			
<b>Application info</b> Nissan Juke (F16) (08/19--) Renault Clio V (06/19--) Renault Captur II (01/20--)			

**Stabilizer link**

16-16 060 0022/HD

MSL1131HD

**Notes**

	Carbon Neutral
	Coupling Rod
Length [mm]	294
Required quantity	2
Thread Size 1	10x1,5
Thread Size 2	10x1,5
reinforced version	
replacement in pairs recommended	

**References**

Dacia 551103022R

Renault 551103022R

Dacia 8200814411

Renault 8200814411

**Application info**

Dacia Duster I (04/10--)

Renault Arkana (08/19--)

Renault Duster II (10/17--)

Dacia Duster II (10/17--)

Renault Duster I (01/11--)

Renault Kaptur (03/16--)

**Stabilizer link**

16-16 060 7057/HD

MSL0170HD

**Notes**

	Carbon Neutral
	Coupling Rod
	Front Axle Left
	Front Axle Right
	with spanner attachment
Length [mm]	364
Required quantity	2
Thread Size 1	M10x1,5
Thread Size 2	M10x1,5
reinforced version	
replacement in pairs recommended	

**References**

Renault 7700805494



**Application info**



Renault Avantime (09/01-05/03)

Renault Laguna I (11/93-08/02)

Renault Espace III (11/96-10/02)

Renault Safrane (04/92-12/00)

Stabilizer link		18-16 060 0000/HD	MSL0171HD
<b>Notes</b>			
	Carbon Neutral		
	Coupling Rod		
	Rear Axle Left		
Length [mm]	220		
Paired article number	18-16 060 0001/HD   MSL0172HD		
Required quantity	1		
Thread Size 1	M10x1,5		
Thread Size 2	M10x1,5		
replacement in pairs recommended			
<b>References</b>			
Jaguar C2C18572		Jaguar C2D49529	
Jaguar XR81693			
<b>Application info</b>			
Jaguar F-Type (10/12--)		Jaguar S-Type (CCX) (10/98-12/08)	
Jaguar XF I (X250) (03/08--)		Jaguar XJ (X350) (03/03-03/09)	
Jaguar XJ (X351) (10/09--)		Jaguar XK (03/06-12/14)	
Stabilizer link		18-16 060 0001/HD	MSL0172HD
<b>Notes</b>			
	Carbon Neutral		
	Coupling Rod		
	Rear Axle Right		
Length [mm]	220		
Paired article number	18-16 060 0000/HD   MSL0171HD		
Required quantity	1		
Thread Size 1	M10x1,5		
Thread Size 2	M10x1,5		
replacement in pairs recommended			
<b>References</b>			
Jaguar C2C18571		Jaguar C2D49528	
Jaguar XR8 1692			
<b>Application info</b>			
Jaguar F-Type (10/12--)		Jaguar S-Type (CCX) (10/98-12/08)	
Jaguar XF I (X250) (03/08--)		Jaguar XJ (X350) (03/03-03/09)	
Jaguar XJ (X351) (10/09--)		Jaguar XK (03/06-12/14)	

Stabilizer link		18-16 060 0002/HD	MSL0173HD
<p><b>Notes</b></p> <p>Carbon Neutral Coupling Rod Front Axle Left Front Axle Right</p> <p>Length [mm] 137 Required quantity 2 Thread Size 1 M10x1,5 Thread Size 2 M10x1,5 reinforced version replacement in pairs recommended</p>			
<p><b>References</b></p> <p>Jaguar XR81694 Jaguar XR827071 Jaguar XR855185</p>			
<p><b>Application info</b></p> <p>Jaguar S-Type (CCX) (10/98-12/08)</p>			
Stabilizer link		18-16 060 0003/HD	MSL0174HD
<p><b>Notes</b></p> <p>Carbon Neutral Coupling Rod Front Axle Left Front Axle Right</p> <p>Length [mm] 146 Required quantity 2 Thread Size 1 M10x1,5 reinforced version replacement in pairs recommended</p>			
<p><b>References</b></p> <p>DAIMLER C2C18573 DAIMLER C2C39468 Jaguar C2C10793 Jaguar C2C18573 Jaguar C2C39468 Jaguar C2D24220 Jaguar T4N1048 Jaguar XR822199</p>			



**Application info**

DAIMLER Super eight (X350) (09/05-12/09)

Jaguar S-Type (CCX) (10/98-12/08)

Jaguar XF I (X250) (03/08--)

Jaguar XJ (X350) (03/03-03/09)

Jaguar XK (03/06-12/14)

Jaguar F-Type (10/12--)

Jaguar XE (X760) (03/15--)

Jaguar XF II (X260) (05/15--)

Jaguar XJ (X351) (10/09--)

**Stabilizer link****18-16 060 0005/HD****MSL0595HD****Notes**

Carbon Neutral  
Coupling Rod  
Front Axle Left  
Front Axle Right  
with spanner attachment

Inner Diameter [mm]

10.2

Length [mm]

138

Required quantity

2

Thread Size 1

M12x1,5

reinforced version

replacement in pairs recommended

**References**

DAIMLER MNC2105AA

Jaguar MNC2105AA

**Application info**

DAIMLER XJ (X30) (10/94-06/03)

Jaguar XJ (X308) (09/96-06/03)

Jaguar XJ (X300) (09/94-12/99)

**Stabilizer link****18-16 060 0007/HD****MSL1073HD****Notes**

Carbon Neutral  
Coupling Rod  
Front Axle Left  
Front Axle Right

Length [mm]

220

Required quantity

2

Thread Size 1

M10x1,5

Thread Size 2

M10x1,5

reinforced version

replacement in pairs recommended

**References**

Jaguar GX733B438BA

Jaguar T4N1049

**Application info**

Jaguar XE (X760) (03/15--)

Jaguar XF II (X260) (05/15--)

**Stabilizer link**

18-16 060 0008/HD

MSL1071HD

**Notes**Carbon Neutral  
Coupling Rod  
Rear Axle Right

212.5

Length [mm]

Paired article number

Required quantity

1

Thread Size 1

M10x1,5

Thread Size 2

M10x1,5

reinforced version

replacement in pairs recommended

**References**

Jaguar T4N3672

**Application info**

Jaguar XE (X760) (03/15--)

Jaguar XF II (X260) (05/15--)

**Stabilizer link**

18-16 060 0009/HD

MSL1072HD

**Notes**Carbon Neutral  
Coupling Rod  
Rear Axle Left

212.5

Length [mm]

Paired article number

18-16 060 0008/HD | MSL1071HD

Required quantity

1

Thread Size 1

M10x1,5

Thread Size 2

M10x1,5

reinforced version

replacement in pairs recommended



**References**

Jaguar T4N3673

**Application info**

Jaguar XE (X760) (03/15--)

Jaguar XF II (X260) (05/15--)

Stabilizer link		18-16 060 0010/HD	MSL1069HD
<b>Notes</b>  Carbon Neutral Coupling Rod Rear Axle Right  Length [mm] 159 Paired article number 18-16 060 0011/HD   MSL1070HD Required quantity 1 Thread Size 1 M10x1,5 Thread Size 2 M10x1,5 reinforced version replacement in pairs recommended			
<b>References</b> Jaguar J9C1129		Land Rover LR114303	
<b>Application info</b> Jaguar E-Pace (X540) (09/17--) Land Rover Range Rover Evoque II (12/18--)		Land Rover Discovery Sport (09/14--) 	
Stabilizer link		18-16 060 0011/HD	MSL1070HD
<b>Notes</b>  Carbon Neutral Coupling Rod Rear Axle Left  Length [mm] 159 Paired article number 18-16 060 0010/HD   MSL1069HD Required quantity 1 Thread Size 1 M10x1,5 Thread Size 2 M10x1,5 reinforced version replacement in pairs recommended			
<b>References</b> Jaguar J9C1131		Land Rover LR114304	
<b>Application info</b> Jaguar E-Pace (X540) (09/17--) Land Rover Range Rover Evoque II (12/18--)		Land Rover Discovery Sport (09/14--) 	

**Stabilizer link**

216 060 0000/HD

MSL0176HD

**Notes**

Carbon Neutral  
Coupling Rod  
Front Axle Left  
Front Axle Right  
with spanner attachment

Length [mm]

290

Required quantity

2

Thread Size 1

M10x1,5

Thread Size 2

M10x1,5

reinforced version

replacement in pairs recommended

**References**

Citroën 5087.65

Citroën 5087.70

Citroën 5087.78

Citroën 5087.79

Fiat 50700464

Fiat 50700941

Fiat 51704008

Fiat 51795269

Fiat 51801136

Fiat 51815479

Fiat 51815480

Fiat 52121199

Fiat 52148016

Fiat 52189859

Ford 1 540 281

Ford 1 580 517

Ford 9S51-5K484-AA

Ford 9S51-5K484-AB

Lancia 50700464

Lancia 50700941

Lancia 51795269

Lancia 51801136

Lancia 52148016

Peugeot 5087.65

Peugeot 5087.70

Peugeot 5087.79

**Application info**

ABARTH 500 (01/08--)

Citroën Nemo (02/08--)

Fiat 500 (07/07--)

Fiat 500e (332\_) (10/20--)

Fiat Bravo (198) (11/06--)

Fiat Fiorino Nuovo (225) (01/07--)

Fiat Linea (10/06--)

Fiat Panda III (02/12--)

Fiat Qubo (02/08--)

Fiat Stilo (10/01-11/10)

Ford KA II (10/08-05/16)

Lancia Delta III (08/08-08/14)

Lancia Ypsilon (846) (05/11--)

Peugeot Bipper (02/08--)

## Stabilizer link

216 060 0001/HD

MSL0177HD

## Notes

Carbon Neutral  
Coupling Rod  
Front Axle Left  
Front Axle Right  
with spanner attachment

Length [mm] 275  
Required quantity 2  
Thread Size 1 M10x1,5  
Thread Size 2 M10x1,5  
reinforced version  
replacement in pairs recommended



## References

Fiat 46413122  
Fiat 51701045  
Lancia 51701045

Fiat 46545743  
Lancia 46545743  
Lancia 60813377

## Application info

Fiat Marea / Multipla (05/96-06/10)  
Lancia Lybra (07/99-10/05)

Lancia Dedra (01/89-07/99)

## Stabilizer link

216 060 0003

MSL0178

## Notes

Coupling Rod  
Front Axle Left  
Front Axle Right

Diameter [mm] 12  
Length [mm] 103  
Required quantity 2  
Thread Size M10x1,25  
replacement in pairs recommended



## References

Alfa Romeo 60570627  
Alfa Romeo 60807583  
Fiat 60807583  
Fiat 7601647  
Lancia 60809242

Alfa Romeo 608 092 42  
Fiat 60570627  
Fiat 60809242  
Lancia 60570627

**Application info**

Alfa Romeo 145 / 146 (07/94-10/01)  
 Alfa Romeo GTV (09/94-10/05)  
 Fiat Brava / Bravo (182) (10/95-06/03)  
 Fiat Tempra / Tipo (07/87-12/98)  
 Lancia Delta I / II (09/79-09/99)

Alfa Romeo 155 (01/92-12/97)  
 Alfa Romeo Spider (916) (09/94-04/05)  
 Fiat Coupé (11/93-08/00)  
 Lancia Dedra (01/89-07/99)

**Stabilizer link****216 060 0004/HD****MSL0179HD****Notes**

Carbon Neutral  
 Coupling Rod  
 Rear Axle Left  
 Rear Axle Right  
 with spanner attachment

Length [mm] 130  
 Required quantity 2  
 Thread Size 1 M10x1,25  
 Thread Size 2 M10x1,25  
 reinforced version  
 replacement in pairs recommended

**References**

Fiat 46799278

Fiat 51717001

**Application info**

Fiat Doblo (119, 223) (11/00--)

**Stabilizer link****216 060 0005/HD****MSL0180HD****Notes**

Carbon Neutral  
 Coupling Rod  
 Front Axle Left  
 Front Axle Right  
 with spanner attachment

Length [mm] 315  
 Required quantity 2  
 Thread Size 1 M10x1,5  
 Thread Size 2 M10x1,5  
 reinforced version  
 replacement in pairs recommended

**References**

Fiat 50703296

Fiat 51856872

**Application info**

Fiat Panda II (09/03--)

**Stabilizer link**

216 060 0006/HD

MSL0181HD

**Notes**

Carbon Neutral  
Coupling Rod  
Rear Axle Left  
Rear Axle Right  
with spanner attachment

Length [mm]

118

Required quantity

2

Thread Size 1

M10x1,5

Thread Size 2

M10x1,5

reinforced version

replacement in pairs recommended

**References**

Fiat 46767267

Fiat 51717000

**Application info**

Fiat Doblo (119, 223) (11/00--)

**Stabilizer link**

216 060 0012/HD

MSL0182HD

**Notes**

Carbon Neutral  
Coupling Rod  
Rear Axle Left  
Rear Axle Right

Length [mm]

100

Required quantity

2

Thread Size 1

M10x1,5

Thread Size 2

M10x1,5

reinforced version

replacement in pairs recommended

**References**

Fiat 1352357080

Fiat 1355449080

Fiat 1355450080

Fiat 1369845080

Lancia 46462049

Lancia 46545749

Lancia 50701813

**Application info**

Fiat Ducato (250) (07/06--)  
Lancia Lybra (07/99-10/05)

Lancia Kappa (08/94-10/01)

**Stabilizer link****216 060 0015/HD****MSL0183HD****Notes**

Carbon Neutral  
Coupling Rod  
Front Axle Left  
Front Axle Right  
with spanner attachment

Length [mm]

270

Required quantity

2

Thread Size 1

M10x1,5

Thread Size 2

M10x1,5

reinforced version

replacement in pairs recommended

**References**

Fiat 71742688

Suzuki 42420-77M00

Suzuki 42420-77M01

Suzuki 42420-80J00

**Application info**

Fiat Sedici (06/06-10/14)

Suzuki Kizashi (FR) (10/10--)

Suzuki SX4 (06/06--)

Suzuki SX4 S-Cross (08/13--)

Suzuki Swift IV (10/10--)

Suzuki Vitara II (LY) (02/15--)

**Stabilizer link****216 060 0016/HD****MSL0184HD****Notes**

Carbon Neutral  
Coupling Rod

Length [mm]

115

Paired article number

216 060 0017/HD | MSL0185HD

Required quantity

1

Thread Size 1

M10x1,5

Thread Size 2

M10x1,5

reinforced version

replacement in pairs recommended

**References**

Alfa Romeo 50515274

Alfa Romeo 51806608

Alfa Romeo 51978680



**Application info**

Alfa Romeo 4C (960) (03/13--)

Alfa Romeo Giulietta (940) (04/10--)

**Stabilizer link****216 060 0017/HD****MSL0185HD****Notes**

Carbon Neutral

Coupling Rod

Length [mm]

115

Paired article number

216 060 0016/HD | MSL0184HD

Required quantity

1

Thread Size 1

M10x1,5

Thread Size 2

M10x1,5

reinforced version

replacement in pairs recommended

**References**

Alfa Romeo 50515275

Alfa Romeo 51806609

Alfa Romeo 51978679

**Application info**

Alfa Romeo 4C (960) (03/13--)

Alfa Romeo Giulietta (940) (04/10--)

**Stabilizer link****216 060 0030/HD****MSL0604HD****Notes**

Carbon Neutral

Coupling Rod

Rear Axle Left

Rear Axle Right

Length [mm]

80

Required quantity

2

Thread Size 1

M12x1,5

Thread Size 2

M12x1,5

reinforced version

replacement in pairs recommended

**References**

Dodge 68052655AA



Fiat K04766435AA

Fiat K68052655AA

**Application info**

Dodge Journey (06/08--)

Fiat Freemont (JC) (08/11--)

Stabilizer link		216 060 0031	MSL0771
<b>Notes</b>  Coupling Rod Front Axle Left Front Axle Right with spanner attachment  Length [mm] 290 Required quantity 2 Thread Size 1 M10x1,5 Thread Size 2 M10x1,5 replacement in pairs recommended			
<b>References</b> Fiat 50700464 Fiat 50700941 Fiat 51795269 Fiat 51801136 Fiat 51909775 Fiat 52148016 Fiat 52189859 Ford 1 540 281 Ford 1 580 517 Ford 9S51-5K484-AA Ford 9S51-5K484-AB Lancia 50700464 Lancia 50700941 Lancia 51795269 Lancia 51801136 Lancia 51909775 Lancia 52148016			
<b>Application info</b> ABARTH 500 (01/08--) Fiat 500e (332_) (10/20--) Fiat Fiorino Nuovo (225) (01/07--) Fiat Qubo (02/08--) Ford KA II (10/08-05/16) Lancia Ypsilon (846) (05/11--) Fiat 500 (07/07--) Fiat Bravo (198) (11/06--) Fiat Panda III (02/12--) Fiat Stilo (10/01-11/10) Lancia Delta III (08/08-08/14)			
Stabilizer link		216 060 0032	MSL0772
<b>Notes</b>  Coupling Rod Front Axle Left Front Axle Right with spanner attachment  Length [mm] 315 Required quantity 2 Thread Size 1 M10x1,5 Thread Size 2 M10x1,5 replacement in pairs recommended			

**References**

Fiat 50703296

Fiat 51856872

**Application info**

Fiat Panda II (09/03--)

**Stabilizer link**

216 060 0033

MSL0773

**Notes**

Coupling Rod  
 Front Axle Left  
 Front Axle Right  
 with spanner attachment

Length [mm]

290

Required quantity

2

Thread Size 1

M10x1,5

Thread Size 2

M10x1,5

replacement in pairs recommended

**References**

Citroën 16 109 299 80

Citroën 5087.65

Citroën 5087.70

Citroën 5087.78

Citroën 5087.79

Fiat 51704008

Fiat 51815479

Fiat 51815480

Peugeot 16 10 929 980

Peugeot 5087.65

Peugeot 5087.70

Peugeot 5087.79

**Application info**

Citroën Nemo (02/08--)

Fiat Fiorino Nuovo (225) (01/07--)

Fiat Linea (10/06--)

Fiat Qubo (02/08--)

Peugeot Bipper (02/08--)

**Stabilizer link**

216 060 0036

MSL0776

**Notes**

Coupling Rod  
 Front Axle Left  
 Front Axle Right  
 with spanner attachment

Length [mm]

300

Required quantity

2

Thread Size 1

M10x1,5

Thread Size 2

M10x1,5

replacement in pairs recommended



**References**

Fiat 51848645

Opel 350 198

Vauxhall 95511247

Fiat 51898527

Opel 95511247

**Application info**

Fiat Doblo (263) (11/09--)

Vauxhall Combo Mk III (07/06--)

Opel Combo D (02/12--)

**Stabilizer link****216 060 0037****MSL0777****Notes**

Coupling Rod  
 Front Axle Left  
 Front Axle Right  
 with spanner attachment

Length [mm]

301

Required quantity

2

Thread Size 1

M10x1,5

Thread Size 2

M10x1,5

replacement in pairs recommended

**References**

Alfa Romeo 50515276

Alfa Romeo 51805870

Fiat 50515276

Fiat 51805870

Lancia 50515276

Alfa Romeo 50531823

Alfa Romeo 55700753

Fiat 50531823

Fiat 55700753

**Application info**

ABARTH Grande Punto (12/07-12/12)

Alfa Romeo Giulietta (940) (04/10--)

Fiat 500L (09/12--)

Fiat Punto Evo (07/08--)

ABARTH Punto III (03/12--)

Alfa Romeo Mito (08/08--)

Fiat Grande Punto (06/05--)

Fiat Punto III (01/12--)

**Stabilizer link** 216 060 0039/HD MSL0921HD

**Notes**

Carbon Neutral  
Coupling Rod  
with spanner attachment

Length [mm] 280  
Required quantity 2  
Thread Size 1 M12x1,5  
Thread Size 2 M12X1,5  
reinforced version  
replacement in pairs recommended



**References**

Alfa Romeo 52182012	Fiat 51939949
Fiat 51977024	Fiat 52060973
Fiat 5218064	Fiat 52182012
Fiat 52201888	Fiat 53403318
Fiat 53477126	Jeep 51939949
Jeep 51977024	Jeep 52060973
Jeep 52118064	Jeep 52182012
Jeep 52201888	Jeep 53477126

**Application info**

Alfa Romeo Tonale (965_) (03/22--)	Fiat 500X (09/14--)
Fiat Tipo (356) (10/15--)	Jeep Compass (MP) (01/16--)
Jeep Renegade (BU, B1) (07/14--)	

**Stabilizer link** 216 060 0040/HD MSL0982HD

**Notes**

Carbon Neutral  
Coupling Rod  
Rear Axle Left  
Rear Axle Right

Length [mm] 183  
Required quantity 2  
Thread Size 1 12x1,5  
Thread Size 2 12x1,5  
reinforced version  
replacement in pairs recommended



**References**

Alfa Romeo 52182013  
 Fiat 52118065  
 Jeep 51942168  
 Jeep 53403319  
 Jeep 68246731AC  
 Jeep K68246731AC

Fiat 51942168  
 Fiat 53403319  
 Jeep 52118065  
 Jeep 68246731AB  
 Jeep K68246731AB

**Application info**

Alfa Romeo Tonale (965\_) (03/22--)  
 Jeep Compass (MP) (01/16--)

Fiat 500X (09/14--)  
 Jeep Renegade (BU, B1) (07/14--)

**Stabilizer link****216 060 0044/HD****MSL1107HD****Notes**

Carbon Neutral  
 Coupling Rod  
 Front Axle Left  
 Front Axle Right  
 Steel  
 Length [mm] 297  
 Required quantity 2  
 Thread Size M10x1,25  
 Thread Size 1 M10x1,25  
 Thread Size 2 M10x1,25

replacement in pairs recommended

**References**



Fiat 51848645  
 Fiat 51935875  
 GENERAL MOTORS 95511247  
 GENERAL MOTORS 95525064  
 Opel 3 50 234  
 Vauxhall 3 50 234  
 Vauxhall 95 51 5339



Fiat 51898527  
 Fiat 52042281  
 GENERAL MOTORS 95515339  
 Opel 3 50 198  
 Vauxhall 3 50 198  
 Vauxhall 95 51 1247  
 Vauxhall 95 52 5064

**Application info**



Fiat Doblo (263) (11/09--)  
 Vauxhall Combo Mk III (07/06--)

Opel Combo D (02/12--)

Stabilizer link		28-16 060 0001	MSL0198
<b>Notes</b>  Coupling Rod Front Axle Left Front Axle Right  Length [mm] 241 Required quantity 2 Thread Size 1 M12x1,25 Thread Size 2 M12x1,25 replacement in pairs recommended			
<b>References</b> Kia 54830 2G000			
<b>Application info</b> Kia Carens II (07/02--) Kia Magentis II (10/05--) Kia Carens III (05/06--) 			
Stabilizer link		28-16 060 0002/HD	MSL0199HD
<b>Notes</b>  Carbon Neutral Coupling Rod Rear Axle Left with spanner attachment  Length [mm] 120 Paired article number 28-16 060 0003/HD   MSL0200HD Required quantity 1 Thread Size 1 M12X1,5 Thread Size 2 M12X1,5 reinforced version replacement in pairs recommended			
<b>References</b> Kia 55580 3E000			
<b>Application info</b> Kia Sorento I (08/02--) 			

Stabilizer link		28-16 060 0003/HD	MSL0200HD
<b>Notes</b>  Carbon Neutral Coupling Rod Rear Axle Right with spanner attachment  Length [mm] 120 Paired article number 28-16 060 0002/HD   MSL0199HD Required quantity 1 Thread Size 1 M12X1,5 Thread Size 2 M12X1,5 reinforced version replacement in pairs recommended			
<b>References</b> Kia 55580 3E050			
<b>Application info</b> Kia Sorento I (08/02--)			
Stabilizer link		28-16 060 0004	MSL0201
<b>Notes</b>  Coupling Rod Front Axle Left  Length [mm] 322 Paired article number 28-16 060 0005   MSL0202 Required quantity 1 Thread Size 1 M12x1,25 Thread Size 2 M12x1,25 replacement in pairs recommended			
<b>References</b> Kia 54830 4D000			
<b>Application info</b> Kia Carnival III (09/05--)			



Stabilizer link		28-16 060 0005	MSL0202
<p><b>Notes</b></p> <p>Coupling Rod Front Axle Right</p> <p>Length [mm] 322</p> <p>Paired article number 28-16 060 0004   MSL0201</p> <p>Required quantity 1</p> <p>Thread Size 1 M12x1,25</p> <p>Thread Size 2 M12x1,25</p> <p>replacement in pairs recommended</p>			
<p><b>References</b></p> <p>Kia 54840 4D000</p>			
<p><b>Application info</b></p> <p>Kia Carnival III (09/05--)</p>			
Stabilizer link		28-16 060 0011/HD	MSL0207HD
<p><b>Notes</b></p> <p>Carbon Neutral Coupling Rod Front Axle Right with spanner attachment</p> <p>Length [mm] 85</p> <p>Paired article number 28-16 060 0022/HD   MSL0217HD</p> <p>Required quantity 1</p> <p>Thread Size 1 M12X1,5</p> <p>Thread Size 2 M12X1,5</p> <p>reinforced version</p> <p>replacement in pairs recommended</p>			
<p><b>References</b></p> <p>Kia 54811 3E060</p> <p>Kia 54811 3E160</p>			
<p><b>Application info</b></p> <p>Kia Sorento I (08/02--)</p>			

**Stabilizer link** **28-16 060 0015/HD** **MSL0211HD**

<b>Notes</b>		
	Carbon Neutral	
	Coupling Rod	
	Rear Axle Left	
	Rear Axle Right	
Length [mm]	130	
Required quantity	2	
Thread Size 1	M10x1,5	
Thread Size 2	M10x1,5	
reinforced version		
replacement in pairs recommended		

<b>References</b>	
Hyundai 55530-17000	Hyundai 55530-17010
Kia 55530 17000	Kia 55530 17010

<b>Application info</b>	
Hyundai Elantra I (03/00-09/06)	Hyundai Matrix (06/01-08/10)
Kia Cerato I (LD) (01/01--)	

**Stabilizer link** **28-16 060 0017/HD** **MSL0212HD**

<b>Notes</b>		
	Carbon Neutral	
	Coupling Rod	
	Front Axle Left	
	with spanner attachment	
Length [mm]	250.5	
Paired article number	28-16 060 0018/HD   MSL0213HD	
Required quantity	1	
Thread Size 1	M10x1,5	
Thread Size 2	M10x1,5	
reinforced version		
replacement in pairs recommended		

<b>References</b>	
Kia 54830 2F000	

<b>Application info</b>	
Kia Cerato I (LD) (01/01--)	

**Stabilizer link**

28-16 060 0018/HD

MSL0213HD

**Notes**

Carbon Neutral  
Coupling Rod  
Front Axle Right  
with spanner attachment

Length [mm]

250.5

Paired article number

28-16 060 0017/HD | MSL0212HD

Required quantity

1

Thread Size 1

M10x1,5

Thread Size 2

M10x1,5

reinforced version

replacement in pairs recommended

**References**

Kia 54840 2F000

**Application info**

Kia Cerato I (LD) (01/01--)

**Stabilizer link**

28-16 060 0022/HD

MSL0217HD

**Notes**

Carbon Neutral  
Coupling Rod  
Front Axle Left  
with spanner attachment

Length [mm]

85

Paired article number

28-16 060 0011/HD | MSL0207HD

Required quantity

1

Thread Size 1

M12X1,5

Thread Size 2

M12X1,5

reinforced version

replacement in pairs recommended

**References**

Kia 54811 3E010

Kia 54811 3E110

**Application info**

Kia Sorento I (08/02--)

**Stabilizer link****28-16 060 0023/HD****MSL0218HD****Notes**

Carbon Neutral  
Coupling Rod  
Front Axle Left  
with spanner attachment

Length [mm]

229

Paired article number

28-16 060 0025/HD | MSL0220HD

Required quantity

1

Thread Size 1

M10x1,5

Thread Size 2

M10x1,5

reinforced version

replacement in pairs recommended

**References**

Hyundai 54830-0X000

Hyundai 54830-0X500

Hyundai 54830-0X501

Hyundai 54830-B4000

Kia 54830 07000

**Application info**

Hyundai i10 I (10/07--)

Hyundai i10 II (08/13--)

Kia Picanto I (04/04--)

**Stabilizer link****28-16 060 0025/HD****MSL0220HD****Notes**

Carbon Neutral  
Coupling Rod  
Front Axle Right  
with spanner attachment

Length [mm]

229

Paired article number

28-16 060 0023/HD | MSL0218HD

Required quantity

1

Thread Size 1

M10x1,5

Thread Size 2

M10x1,5

reinforced version

replacement in pairs recommended

**References**

Hyundai 54840-0X000

Hyundai 54840-0X500

Hyundai 54840-0X501

Hyundai 54840-B4000

Kia 54840 07000

**Application info**

Hyundai i10 I (10/07--)  
Kia Picanto I (04/04--)

Hyundai i10 II (08/13--)

**Stabilizer link****28-16 060 0028****MSL0223****Notes**

Coupling Rod  
Front Axle Left  
Front Axle Right

Length [mm] 243  
Required quantity 2  
Thread Size 1 M12x1,25  
Thread Size 2 M12x1,25  
replacement in pairs recommended

**References**

Hyundai 54830-2H000  
Hyundai 54830-2H200  
Kia 54830 2H001  
Kia 54830 2H200

Hyundai 54830-2H100  
Kia 54830 2H000  
Kia 54830 2H100

**Application info**

Hyundai Elantra IV (09/05--)  
Kia Cee'd I (12/06-02/13)

Hyundai i30 I (10/07-06/12)  
Kia Cerato II (TD) (01/09--)

**Stabilizer link****28-16 060 0029****MSL0224****Notes**

Coupling Rod  
Rear Axle Left  
Rear Axle Right

Length [mm] 170  
Required quantity 2  
Thread Size 1 M10x1,25  
Thread Size 2 M10x1,25  
replacement in pairs recommended

**References**

Hyundai 55530-1H000  
Kia 55530 1H000

Hyundai 55530-1H100  
Kia 55530 1H100

**Application info**

Hyundai i30 I (10/07-06/12)

Kia Cee'd I (12/06-02/13)

**Stabilizer link****28-16 060 0035****MSL0778****Notes**

Coupling Rod  
Front Axle Left  
with spanner attachment

Length [mm] 229  
Paired article number 28-16 060 0036 | MSL0779  
Required quantity 1  
Thread Size 1 M10x1,5  
Thread Size 2 M10x1,5  
replacement in pairs recommended

**References**

Hyundai 54830-0X000 Hyundai 54830-0X500  
Hyundai 54830-0X501 Hyundai 54830-B4000  
Kia 54830 07000

**Application info**

Hyundai i10 I (10/07--)  
Kia Picanto I (04/04--)

Hyundai i10 II (08/13--)

**Stabilizer link****28-16 060 0036****MSL0779****Notes**

Coupling Rod  
Front Axle Right  
with spanner attachment

Length [mm] 229  
Paired article number 28-16 060 0035 | MSL0778  
Required quantity 1  
Thread Size 1 M10x1,5  
Thread Size 2 M10x1,5  
replacement in pairs recommended

**References**

Hyundai 54840-0X000 Hyundai 54840-0X500  
Hyundai 54840-0X501 Hyundai 54840-B4000  
Kia 54840 07000

**Application info**

Hyundai i10 I (10/07--)  
Kia Picanto I (04/04--)

Hyundai i10 II (08/13--)

## Stabilizer link

28-16 060 0037/HD

MSL1004HD

## Notes

Carbon Neutral  
Coupling Rod  
Front Axle Left  
Front Axle Right

Length [mm]

282

Required quantity

2

Thread Size 1

M12X1,25

Thread Size 2

M12X1,25

reinforced version

replacement in pairs recommended



## References

Hyundai 54830-25500

Hyundai 54830-2Y500

Hyundai 54830-A6000

Hyundai 54830-D3000

Kia 54830 25500

Kia 54830 2Y500

Kia 54830 D7000

Kia 54830 H8000

Hyundai 54830-2S500

Hyundai 54830-4V000

Hyundai 54830-C8000

Hyundai 54830-D7000

Kia 54830 2S500

Kia 54830 4V000

Kia 54830 D9000

Kia 54830-A6000

## Application info

Hyundai Accent V (01/18--)

Hyundai Creta I (01/16--)

Hyundai Solaris (01/17--)

Hyundai Tucson II (05/15--)

Hyundai i20 II (11/14--)

Hyundai ix35 (08/09--)

Kia Cee'd III (03/12--)

Kia Sportage IV (09/15--)

Hyundai Bayon (BC3) (05/21--)

Hyundai Elantra V (09/10--)

Hyundai Tucson I (06/04--)

Hyundai Venue (07/19--)

Hyundai i30 II (06/11--)

Kia Cee'd II (05/12--)

Kia Rio IV (01/17--)

Kia Stonic (07/17--)

**Stabilizer link****28-16 060 0038/HD****MSL1043HD****Notes**

Carbon Neutral  
Coupling Rod  
Rear Axle Right

Length [mm]

94

Paired article number

28-16 060 0039/HD | MSL1046HD

Required quantity

1

Thread Size 1

M12X1,5

Thread Size 2

M12X1,5

reinforced version

replacement in pairs recommended

**References**

Hyundai 55540-C1100

Kia 55540 C1100

**Application info**

Hyundai Sonata VII (06/14--)

Kia Optima IV (09/15--)

**Stabilizer link****28-16 060 0039/HD****MSL1046HD****Notes**

Carbon Neutral  
Coupling Rod  
Rear Axle Left

Length [mm]

94

Paired article number

28-16 060 0038/HD | MSL1043HD

Required quantity

1

Thread Size 1

M12X1,5

Thread Size 2

M12X1,5

reinforced version

replacement in pairs recommended

**References**

Hyundai 55530-C1100



Kia 55530 C1100



**Application info**

Hyundai Sonata VII (06/14--)

Kia Optima IV (09/15--)



Stabilizer link		28-16 060 0040/HD	MSL1007HD
<b>Notes</b>  Carbon Neutral Coupling Rod Front Axle Right  Length [mm] 349 Paired article number 28-16 060 0041/HD   MSL1008HD Required quantity 1 Thread Size 1 M12X1,25 Thread Size 2 M12X1,25 reinforced version replacement in pairs recommended			
<b>References</b> Hyundai 54840-C1000 Kia 54840 C1000		Hyundai 54840-E6000 Kia 54840 E6000	
<b>Application info</b> Hyundai Sonata VII (06/14--) Kia Optima IV (09/15--)			
Stabilizer link		28-16 060 0041/HD	MSL1008HD
<b>Notes</b>  Carbon Neutral Coupling Rod Front Axle Left  Length [mm] 349 Paired article number 28-16 060 0040/HD   MSL1007HD Required quantity 1 Thread Size 1 M12X1,25 Thread Size 2 M12X1,25 reinforced version replacement in pairs recommended			
<b>References</b> Hyundai 54830-C1000 Kia 54830 C1000		Hyundai 54830-E6000 Kia 54830 E6000	
<b>Application info</b> Hyundai Sonata VII (06/14--) Kia Optima IV (09/15--)			

Stabilizer link		28-16 060 0042/HD	MSL1048HD
<b>Notes</b>			
	Carbon Neutral Coupling Rod Rear Axle Left Rear Axle Right		
Length [mm]	116		
Required quantity	2		
Thread Size 1	M12 X 1,25		
Thread Size 2	M12 X 1,25		
reinforced version replacement in pairs recommended			
<b>References</b>			
Hyundai 55530-C5001		Kia 55530 C5000	
Kia 55530 C5001		Kia 55540 C5000	
<b>Application info</b>			
Hyundai Santa Fé IV (02/18--)		Kia Sorento III (01/15--)	
Stabilizer link		28-16 060 0043/HD	MSL1023HD
<b>Notes</b>			
	Carbon Neutral Coupling Rod Front Axle Left Front Axle Right		
Length [mm]	350.5		
Required quantity	2		
Thread Size 1	M12X1,5		
Thread Size 2	M12X1,5		
reinforced version replacement in pairs recommended			
<b>References</b>			
Hyundai 54830-C5000		Hyundai 54830-N9000	
Kia 54830 C5000		Kia 54830 N9000	
<b>Application info</b>			
Hyundai Santa Fé IV (02/18--)		Hyundai Tucson III (10/20--)	
Kia EV9 (06/23--)		Kia Sorento III (01/15--)	
Kia Sorento IV (03/20--)		Kia Sportage V (NQ5) (09/21--)	

**Stabilizer link****28-16 060 0044/HD****MSL1124HD****Notes**

Carbon Neutral  
Coupling Rod  
Rear Axle Left  
Rear Axle Right

Length [mm]

73

Required quantity

2

Thread Size 1

12x1,5

reinforced version

replacement in pairs recommended

**References**

Hyundai 55530-G2000

Kia 55530 G2000

**Application info**

Hyundai Elantra VI (09/15--)

Hyundai Kona I (06/17--)

Kia Ceed IV (03/18--)

Kia Niro I (DE) (09/16--)

Hyundai Ioniq (AE) (03/16--)

Hyundai i30 III (11/16--)

Kia Cerato IV (BD, BDM) (02/18--)

Kia Soul III (SK3) (01/19--)

**Stabilizer link****28-16 060 0045/HD****MSL1096HD****Notes**

Carbon Neutral  
Coupling Rod  
Front Axle Left  
Front Axle Right

Length [mm]

250

Required quantity

2

Thread Size 1

M10 X 1,25

Thread Size 2

M10 X 1,25

reinforced version

replacement in pairs recommended

**References**

Kia 54830-G6000

**Application info**

Kia Picanto III (03/17--)

**Stabilizer link****28-16 060 0046/HD****MSL1105HD****Notes**

Carbon Neutral  
Coupling Rod  
Front Axle Right

Length [mm] 288  
Paired article number 28-16 060 0047/HD | MSL1106HD  
Paired article number 37-40 910 0025  
Required quantity 1  
Thread Size 1 M12x1,25  
Thread Size 2 M12X1,25  
reinforced version  
replacement in pairs recommended

**References**

Kia 54840 A4000

Kia 54840 A4100

**Application info**

Kia Carens IV (03/13--)

**Stabilizer link****28-16 060 0047/HD****MSL1106HD****Notes**

Carbon Neutral  
Coupling Rod  
Front Axle Left

Length [mm] 288  
Paired article number 28-16 060 0046/HD | MSL1105HD  
Required quantity 1  
Thread Size 1 M12x1,5  
Thread Size 2 M12X1,5  
reinforced version  
replacement in pairs recommended

**References**

Kia 54830 A4000

Kia 54830 A4100

**Application info**

Kia Carens IV (03/13--)

**Stabilizer link****28-16 060 0048****MSL1195****Notes**

Coupling Rod  
Rear Axle Left  
Rear Axle Right

Length [mm] 180  
Required quantity 2  
Thread Size 1 M10x1,25  
Thread Size 2 M10X1,25  
replacement in pairs recommended

**References**

Hyundai 55530-2G500  
Hyundai 55530-2H200  
Kia 55530 2G500

Hyundai 55530-2H000  
Kia 55530 2G000

**Application info**

Hyundai Elantra IV (09/05--)  
Kia Magentis II (10/05--)

Hyundai i30 I (10/07-06/12)

**Stabilizer link****29-16 060 0006****MSL0228****Notes**

Coupling Rod  
Rear Axle Left  
Rear Axle Right

Length [mm] 217  
Required quantity 2  
Thread Size 1 M10x1,25  
Thread Size 2 M10x1,25  
replacement in pairs recommended

**References**

BUICK 96561754  
Daewoo 96561754

Chevrolet 96561754

**Application info**

Chevrolet Lacetti (03/03--)  
Daewoo Lacetti (02/02--)

Chevrolet Nubira (01/05-12/11)  
Daewoo Nubira (KLAN) (07/03--)

**Stabilizer link** **29-16 060 0007/HD** **MSL0229HD**

**Notes**

Carbon Neutral  
Coupling Rod  
Front Axle Right  
with spanner attachment

Length [mm] 270  
Paired article number 29-16 060 0008/HD | MSL0230HD  
Required quantity 1  
Thread Size 1 M10x1,5  
Thread Size 2 M10x1,5  
reinforced version  
replacement in pairs recommended



**References**

Buick 96403100 Chevrolet 96403100  
Daewoo 96403100

**Application info**

Chevrolet Lacetti (03/03--)  
Daewoo Lacetti (02/02--)  
Daewoo Nubira (KLAN) (07/03--)  
Chevrolet Nubira (01/05-12/11)  
Daewoo Nubira (KLAJ) (04/97--)

**Stabilizer link** **29-16 060 0008/HD** **MSL0230HD**

**Notes**

Carbon Neutral  
Coupling Rod  
Front Axle Left  
with spanner attachment

Length [mm] 270  
Paired article number 29-16 060 0007/HD | MSL0229HD  
Required quantity 1  
Thread Size 1 M10x1,5  
Thread Size 2 M10x1,5  
reinforced version  
replacement in pairs recommended



**References**

Buick 96403099 Chevrolet 96403099  
Daewoo 96403099

**Application info**

Chevrolet Lacetti (03/03--)  
 Daewoo Lacetti (02/02--)  
 Daewoo Nubira (KLAN) (07/03--)

Chevrolet Nubira (01/05-12/11)  
 Daewoo Nubira (KLAJ) (04/97--)

**Stabilizer link****29-16 060 0009/HD****MSL0231HD****Notes**

Carbon Neutral  
 Coupling Rod  
 Front Axle Left  
 Front Axle Right  
 with spanner attachment

Length [mm] 261  
 Required quantity 2  
 Thread Size 1 M10x1,5  
 Thread Size 2 M10x1,5  
 reinforced version  
 replacement in pairs recommended

**References**

Chevrolet 95994977  
 Chevrolet 96391875  
 Daewoo 96288865

Chevrolet 96275798  
 Daewoo 96275798  
 Daewoo 96391875

**Application info**

Chevrolet Astro I (02/03-05/08)  
 Chevrolet Rezzo (03/05--)  
 Daewoo Nubira (KLAJ) (04/97--)

Chevrolet Aveo I (01/03--)  
 Daewoo Kalos (09/02--)  
 Daewoo Rezzo (06/00--)

**Stabilizer link****29-16 060 0013****MSL0780****Notes**

Coupling Rod  
 Front Axle Left  
 with spanner attachment

Length [mm] 270  
 Paired article number 29-16 060 0014 | MSL0781  
 Required quantity 1  
 Thread Size 1 M10x1,5  
 Thread Size 2 M10x1,5  
 replacement in pairs recommended



**References**

Buick 96403099  
Daewoo 96403099

Chevrolet 96403099

**Application info**

Chevrolet Lacetti (03/03--)  
Daewoo Lacetti (02/02--)  
Daewoo Nubira (KLAN) (07/03--)

Chevrolet Nubira (01/05-12/11)  
Daewoo Nubira (KLAJ) (04/97--)

**Stabilizer link****29-16 060 0014****MSL0781****Notes**

Coupling Rod  
Front Axle Right  
with spanner attachment  
Length [mm] 270  
Paired article number 29-16 060 0013 | MSL0780  
Required quantity 1  
Thread Size 1 M10x1,5  
Thread Size 2 M10x1,5

replacement in pairs recommended

**References**

Buick 96403100  
Daewoo 96403100

Chevrolet 96403100

**Application info**

Chevrolet Lacetti (03/03--)  
Daewoo Lacetti (02/02--)  
Daewoo Nubira (KLAN) (07/03--)

Chevrolet Nubira (01/05-12/11)  
Daewoo Nubira (KLAJ) (04/97--)

**Stabilizer link****29-16 060 0015****MSL0782****Notes**

Coupling Rod  
Front Axle Left  
Front Axle Right  
with spanner attachment  
Length [mm] 261  
Required quantity 2  
Thread Size 1 M10x1,5  
Thread Size 2 M10x1,5

replacement in pairs recommended





**References**

Chevrolet 95994977  
 Chevrolet 96391875  
 Daewoo 96288865

Chevrolet 96275798  
 Daewoo 96275798  
 Daewoo 96391875

**Application info**

Chevrolet Astro I (02/03-05/08)  
 Chevrolet Rezzo (03/05--)  
 Daewoo Nubira (KLAJ) (04/97--)

Chevrolet Aveo I (01/03--)  
 Daewoo Kalos (09/02--)  
 Daewoo Rezzo (06/00--)

**Stabilizer link****29-16 060 0016/HD****MSL0908HD****Notes**

Carbon Neutral  
 Coupling Rod  
 Front Axle Left  
 Front Axle Right  
 with spanner attachment

Length [mm] 235  
 Required quantity 2  
 Thread Size 1 M10x1,25  
 Thread Size 2 M10x1,25  
 reinforced version  
 replacement in pairs recommended

**References**

Chevrolet 95947829

**Application info**

Chevrolet Spark (M300) (12/09--)

**Stabilizer link****300 335 5105****MSL0270****Notes**

Coupling Rod  
 Rear Axle Left  
 Rear Axle Right

Length [mm] 66  
 Required quantity 2  
 Thread Size 1 M10x1,5  
 Thread Size 2 M10x1,5  
 replacement in pairs recommended



**References**

BMW 1 092 292

BMW 33 55 1 092 292

BMW 1 095 532

BMW 33 55 1 095 532

**Application info**

BMW 5 (E39) (09/95-06/04)

**Stabilizer link**

30-16 060 0000/HD

MSL0232HD

**Notes**

Carbon Neutral  
Coupling Rod  
Front Axle Left  
Front Axle Right  
with spanner attachment

Length [mm]

360

Required quantity

2

Thread Size 1

M12X1,5

Thread Size 2

M12X1,5

reinforced version

replacement in pairs recommended

**References**

Daihatsu 48820-0D010

Toyota 48820-0D010

Toyota 48820-52030

Subaru 48820-52030

Toyota 48820-0D020

Toyota 48820-52040

**Application info**

Daihatsu Charade V (05/11--)

Toyota Urban Cruiser (NCP11) (07/07-03/16)

Toyota Yaris II (01/05-12/14)

Subaru Trezia (11/10--)

Toyota Verso S (NCP12, NSP12) (11/10-10/16)

Toyota Yaris III (12/10--)

**Stabilizer link**

30-16 060 0001/HD

MSL0233HD

**Notes**

Carbon Neutral  
Coupling Rod  
Rear Axle Left  
Rear Axle Right

Length [mm]

104

Required quantity

2

Thread Size 1

M10x1,5

Thread Size 2

M10x1,5

reinforced version

replacement in pairs recommended



**References**

Toyota 48830-05010	Toyota 48830-05011
Toyota 48830-12060	Toyota 48830-20010
Toyota 48830-32010	Toyota 48830-32020

**Application info**

Toyota Camry (V2) (08/86-02/93)	Toyota Carina (T17) (12/87-06/92)
Toyota Carina (T19) (02/92-09/97)	Toyota Celica (T16) (08/85-12/89)
Toyota Celica (T18) (09/89-12/94)	Toyota Celica (T20) (09/93-11/99)
Toyota Corolla (E10) (06/91-12/99)	Toyota Corolla (E11) (06/95-06/02)
Toyota Corolla (E9) (05/87-04/97)	Toyota Corona (T190) (10/91-04/98)

**Stabilizer link**

30-16 060 0002/HD

MSL0234HD

**Notes**

Carbon Neutral  
Coupling Rod  
Front Axle Right  
with spanner attachment

Length [mm]	71
Paired article number	30-16 060 0003/HD   MSL0235HD
Required quantity	1
Thread Size 1	M10x1,5
Thread Size 2	M10x1,5
reinforced version	
replacement in pairs recommended	







**References**

Toyota 48820-05011	Toyota 48820-05012
Toyota 48820-20040	Toyota 48820-44010

**Application info**

Toyota Avensis (T22) (09/97-02/03)	Toyota Carina (T19) (02/92-09/97)
Toyota Corona (T190) (10/91-04/98)	Toyota Picnic (05/96-12/01)

Stabilizer link		30-16 060 0003/HD	MSL0235HD
<b>Notes</b>  Carbon Neutral Coupling Rod Front Axle Left with spanner attachment  Length [mm] 71 Paired article number 30-16 060 0002/HD   MSL0234HD Required quantity 1 Thread Size 1 M10x1,5 Thread Size 2 M10x1,5 reinforced version replacement in pairs recommended			
<b>References</b> Toyota 48810-05011 Toyota 48810-05012 Toyota 48810-20020 Toyota 48810-44010			
<b>Application info</b> Toyota Avensis (T22) (09/97-02/03) Toyota Carina (T19) (02/92-09/97) Toyota Corona (T190) (10/91-04/98) Toyota Picnic (05/96-12/01)			
Stabilizer link		30-16 060 0004	MSL0236
<b>Notes</b>  Coupling Rod Rear Axle Left Rear Axle Right  Length [mm] 137 Required quantity 2 Thread Size 1 M12x1,25 Thread Size 2 M10x1,25 replacement in pairs recommended			
<b>References</b> Lexus 48830-42022 Toyota 48817-42020 Toyota 48817-42021 Toyota 48817-42030 Toyota 48830-42020 Toyota 48830-42021 Toyota 48830-42022			
<b>Application info</b> Lexus NX I (_Z1_) (07/14--) Toyota RAV 4 III (06/05-08/14) Toyota RAV 4 IV (12/12--)			

Stabilizer link		30-16 060 0006/HD	MSL0238HD
<p><b>Notes</b></p> <p>Carbon Neutral Coupling Rod Front Axle Left Front Axle Right with spanner attachment</p> <p>Length [mm] 70 Required quantity 2 Thread Size 1 M10X1,5 Thread Size 2 M10x1,5 reinforced version replacement in pairs recommended</p>			
<p><b>References</b></p> <p>Toyota 48820-20010</p>			
<p><b>Application info</b></p> <p>Toyota Celica (T16) (08/85-12/89) Toyota Celica (T18) (09/89-12/94) Toyota Corolla (E9) (05/87-04/97)</p>			
Stabilizer link		30-16 060 0008	MSL0239
<p><b>Notes</b></p> <p>Coupling Rod Rear Axle Left Rear Axle Right</p> <p>Length [mm] 238 Required quantity 2 Thread Size 1 M10x1,25 Thread Size 2 M10x1,25 replacement in pairs recommended</p>			
<p><b>References</b></p> <p>Lexus 48830-48010 Toyota 48830-06030 Toyota 48830-48010</p>			
<p><b>Application info</b></p> <p>Lexus RX (GYL) III (12/08-12/15) Lexus RX (MCU) II (02/03-12/08) Toyota Camry (V30) (08/01-11/06)</p>			

**Stabilizer link****30-16 060 0009/HD****MSL0240HD****Notes**

Carbon Neutral  
Coupling Rod  
Front Axle Left  
Front Axle Right  
with spanner attachment

Length [mm]

63

Required quantity

2

Thread Size 1

M10x1,5

Thread Size 2

M10x1,5

reinforced version

replacement in pairs recommended

**References**

Lexus 48820-33010

Toyota 48820-02010

Toyota 48820-20020

Toyota 48820-20021

Toyota 48820-33010

**Application info**

Lexus ES (VCV10\_, VZV21\_) I, II (09/89-12/97)

Toyota Camry (V10) (10/82-06/98)

Toyota Celica (T18) (09/89-12/94)

Toyota Celica (T20) (09/93-11/99)

Toyota Corolla (E10) (06/91-12/99)

Toyota Corolla (E11) (06/95-06/02)

Toyota RAV 4 I (01/94-09/00)

**Stabilizer link****30-16 060 0014/HD****MSL0242HD****Notes**

Carbon Neutral  
Coupling Rod  
Front Axle Left  
Front Axle Right  
with spanner attachment

Length [mm]

284

Required quantity

2

Thread Size 1

M12X1,5

Thread Size 2

M12X1,5

reinforced version

replacement in pairs recommended

**References**

Toyota 48820-74010

**Application info**

Toyota iQ (11/08-12/15)

**Stabilizer link**

30-16 060 0017/HD

MSL0243HD

**Notes**

Carbon Neutral  
Coupling Rod  
Front Axle Left  
Front Axle Right  
with spanner attachment

Length [mm] 285  
Required quantity 2  
Thread Size 1 M12X1,5  
Thread Size 2 M12X1,5  
reinforced version  
replacement in pairs recommended

**References**

Hyundai 54830-0U000  
Hyundai 54830-4L000  
Kia 54830 2V000  
Nissan 54618-BA60A  
Nissan 54618-CY00A  
Toyota 48820-47010

Hyundai 54830-2V000  
Kia 54830 0U000  
Kia 54830 4L000  
Nissan 54618-BA60B  
Renault 54618CY00A

**Application info**

Hyundai Accent IV (08/10--)  
Hyundai Veloster I (03/11-12/17)  
Kia Cee'd II (05/12--)  
Kia Rio III (09/10--)  
Nissan Juke (F15) (06/10--)  
Nissan Leaf II (ZE1) (08/17--)  
Nissan Pulsar (08/10--)  
Nissan Sentra VII (B17) (08/12--)  
Toyota Avensis (T25) (01/03-11/08)  
Toyota Corolla Verso (03/04-04/09)  
Toyota Prius II (09/03-12/09)

Hyundai Elantra V (09/10--)  
Hyundai i30 II (06/11--)  
Kia Cerato III (YD) (09/12--)  
Kia Soul II (02/14--)  
Nissan Leaf I (ZE0) (11/10--)  
Nissan NV200 (02/10--)  
Nissan Qashqai II (J11\_) (11/13--)  
Renault Kadjar (06/15--)  
Toyota Corolla (E12) (08/00-12/08)  
Toyota MR 2 (W3) (10/99-06/07)

**Stabilizer link****30-16 060 0018/HD****MSL0244HD****Notes**

Carbon Neutral  
Coupling Rod  
Rear Axle Left  
Rear Axle Right

Length [mm]

127

Required quantity

2

Thread Size 1

M12x1,25

Thread Size 2

M10x1,25

replacement in pairs recommended

**References**

Lexus 48830-05030

Lexus 48830-12070

Toyota 48830-05030

Toyota 48830-12070

**Application info**

Lexus CT (ZWA1) (12/10--)

Toyota Auris I (10/06-09/12)

Toyota Auris II (10/12-12/18)

Toyota Avensis (T27) (11/08-10/18)

**Stabilizer link****30-16 060 0026/HD****MSL0248HD****Notes**

Carbon Neutral  
Coupling Rod  
Front Axle Left  
Front Axle Right  
with spanner attachment

Length [mm]

63

Required quantity

2

Thread Size 1

M12X1,5

Thread Size 2

M12X1,5

reinforced version

replacement in pairs recommended

**References**

Toyota 48820-42010

**Application info**

Toyota RAV 4 I (01/94-09/00)



**Stabilizer link****30-16 060 0029/HD****MSL0249HD****Notes**

Carbon Neutral  
Coupling Rod  
Rear Axle Right  
with spanner attachment

Length [mm] 100  
Paired article number 30-16 060 0045/HD | MSL0262HD  
Required quantity 1  
Thread Size 1 M10x1,5  
Thread Size 2 M10x1,5  
reinforced version  
replacement in pairs recommended

**References**

Toyota 48830-21020

**Application info**

Toyota Avensis (T25) (01/03-11/08)

**Stabilizer link****30-16 060 0032/HD****MSL0252HD****Notes**

Carbon Neutral  
Coupling Rod  
Front Axle Right

Length [mm] 140  
Paired article number 30-16 060 0052/HD | MSL0266HD  
Required quantity 1  
Thread Size 1 M12x1,75  
Thread Size 2 M12x1,75  
reinforced version  
replacement in pairs recommended

**References**

Lexus 48820-0K030

Lexus 48820-60050

Toyota 48820-0K040

Lexus 48820-0K040

Toyota 48820-0K030

Toyota 48820-60050

**Application info**

Lexus GX I (11/01-11/09)



Toyota Fortuner (\_N15\_, \_N16\_) (05/15--)

Toyota Land Cruiser (J12) (09/02-12/10)

Toyota Fortuner (\_N5\_, \_N6\_) (06/04-09/15)

Toyota Hilux (KUN) (08/04--)

Toyota Land Cruiser (J15) (07/09--)

Stabilizer link		30-16 060 0037/HD	MSL0257HD
<b>Notes</b>			
	Carbon Neutral		
	Coupling Rod		
Length [mm]	110		
Required quantity	2		
Thread Size 1	M10x1,5		
Thread Size 2	M10x1,5		
reinforced version			
replacement in pairs recommended			
<b>References</b>			
Toyota 48820-14011		Toyota 48820-24010	
Toyota 48830-14050		Toyota 48840-14030	
<b>Application info</b>			
Toyota Celica (ZZT23) (08/99-03/06)		Toyota Supra III (MA70) (01/86-05/93)	
Toyota Supra IV (JZA80) (05/93-07/02)			
Stabilizer link		30-16 060 0043/HD	MSL0260HD
<b>Notes</b>			
	Carbon Neutral		
	Coupling Rod		
	Front Axle Left		
	Front Axle Right		
	with spanner attachment		
Length [mm]	260		
Required quantity	2		
Thread Size 1	M12X1,5		
Thread Size 2	M12X1,5		
reinforced version			
replacement in pairs recommended			
<b>References</b>			
Lexus 48820-06040		Lexus 48820-28050	
Toyota 48820-06040		Toyota 48820-28050	
<b>Application info</b>			
Lexus RX (GYL) III (12/08-12/15)		Lexus RX (MCU) II (02/03-12/08)	
Toyota Camry (V30) (08/01-11/06)		Toyota Previa (AC_) (02/00-02/06)	

**Stabilizer link**

30-16 060 0045/HD

MSL0262HD

**Notes**

Carbon Neutral  
Coupling Rod  
Rear Axle Left  
with spanner attachment

Length [mm] 100  
Paired article number 30-16 060 0029/HD | MSL0249HD  
Required quantity 1  
Thread Size 1 M10x1,5  
Thread Size 2 M10x1,5  
reinforced version  
replacement in pairs recommended

**References**

Toyota 48840-21010

**Application info**

Toyota Avensis (T25) (01/03-11/08)

**Stabilizer link**

30-16 060 0046/HD

MSL0263HD

**Notes**

Carbon Neutral  
Coupling Rod  
Front Axle Left  
Front Axle Right  
with spanner attachment

Length [mm] 280  
Required quantity 2  
Thread Size 1 M12X1,5  
Thread Size 2 M12X1,5  
reinforced version  
replacement in pairs recommended

**References**

Toyota 48820-44020

**Application info**

Toyota Avensis Verso (05/01-12/11)

**Stabilizer link****30-16 060 0047/HD****MSL0264HD****Notes**

Carbon Neutral  
Coupling Rod  
Front Axle Left  
Front Axle Right  
with spanner attachment

Length [mm]

285

Required quantity

2

Thread Size 1

M10x1,5

Thread Size 2

M10x1,5

reinforced version

replacement in pairs recommended

**References**

Nissan 54616-4A00B

Suzuki 42420-M68K00

Toyota 48820-02020

Toyota 48820-32010

Toyota 48820-42020

**Application info**

Nissan Pixo (03/09--)

Suzuki Alto VII (01/09--)

Toyota Celica (ZZT23) (08/99-03/06)

Toyota Corolla (E12) (08/00-12/08)

Toyota RAV 4 II (05/00-11/05)

**Stabilizer link****30-16 060 0050/HD****MSL1077HD****Notes**

Carbon Neutral  
Coupling Rod  
Front Axle Left  
Front Axle Right

Length [mm]

330

Required quantity

2

Thread Size 1

12x1,25

Thread Size 2

12x1,25

reinforced version

replacement in pairs recommended

**References**

Lexus 48820-47040

Suzuki T488204704

Toyota 48820-47040

**Application info**

Lexus UX (\_AA1\_, \_AH1\_) (10/18--)  
Toyota Corolla (\_E21\_) (10/18--)

Toyota CH-R I (10/16--)  
Toyota Prius IV (09/15--)

**Stabilizer link****30-16 060 0051/HD****MSL1109HD****Notes**

Carbon Neutral  
Coupling Rod  
Rear Axle Left  
Rear Axle Right

Inner Diameter 2 [mm] 12  
Length [mm] 93  
Required quantity 2  
Thread Size 1 M12x1,5  
reinforced version  
replacement in pairs recommended

**References**

Lexus 48830-47010

Toyota 48830-47010

**Application info**

Lexus ES (\_Z10\_) VII (07/18--)  
Toyota CH-R I (10/16--)  
Toyota Prius IV (09/15--)

Lexus UX (\_AA1\_, \_AH1\_) (10/18--)  
Toyota Corolla (\_E21\_) (10/18--)

**Stabilizer link****30-16 060 0052/HD****MSL0266HD****Notes**

Carbon Neutral  
Coupling Rod  
Front Axle Left

Length [mm] 140  
Paired article number 30-16 060 0032/HD | MSL0252HD  
Required quantity 1  
Thread Size 1 M12x1,75  
Thread Size 2 M12x1,75  
reinforced version  
replacement in pairs recommended

**References**

Lexus 48810-0K010  
Lexus 48810-60040  
Toyota 48810-0K020

Lexus 48810-0K020  
Toyota 48810-0K010  
Toyota 48810-60040

**Application info**

Lexus GX I (11/01-11/09)

Toyota Fortuner (\_N15\_, \_N16\_) (05/15--)

Toyota Land Cruiser (J12) (09/02-12/10)

Toyota Fortuner (\_N5\_, \_N6\_) (06/04-09/15)

Toyota Hilux (KUN) (08/04--)

Toyota Land Cruiser (J15) (07/09--)

**Stabilizer link****30-16 060 0053/HD****MSL0267HD****Notes**

Carbon Neutral  
Coupling Rod  
Front Axle Left  
Front Axle Right  
with spanner attachment

Length [mm]

360

Required quantity

2

Thread Size 1

M12X1.25

Thread Size 2

M12X1.25

reinforced version

replacement in pairs recommended

**References**

Lexus 48820-02070

Lexus 48820-47020

Toyota 48820-0R010

Toyota 48820-47020

Lexus 48820-42030

Toyota 48820-02070

Toyota 48820-42030

Toyota 48820-47030

**Application info**

Lexus CT (ZWA1) (12/10--)

Toyota Auris II (10/12-12/18)

Toyota Corolla (E14, E15) (10/06--)

Toyota Previa (XR50) (10/05--)

Toyota Prius Plus (ZVW4) (05/11--)

Toyota RAV 4 IV (12/12--)

Toyota Auris I (10/06-09/12)



Toyota Avensis (T27) (11/08-10/18)

Toyota Corolla (E170) (06/13-08/19)

Toyota Prius III (06/08--)

Toyota RAV 4 III (06/05-08/14)

Toyota Verso (AUR2, ZGR2) (04/09-08/18)

Stabilizer link		30-16 060 0073	MSL0783
<b>Notes</b>  Coupling Rod Front Axle Left Front Axle Right with spanner attachment  Length [mm] 285 Required quantity 2 Thread Size 1 M10x1,5 Thread Size 2 M10x1,5 replacement in pairs recommended			
<b>References</b> Nissan 54616-4A00B Suzuki 42420-M68K00 Toyota 48820-02020 Toyota 48820-32010 Toyota 48820-42020			
<b>Application info</b> Audi A3 II (8P_) (05/03-12/15) Nissan Pixo (03/09--) Seat Leon II / Toledo III / Altea (1P_ ,5P_) (03/04--) Skoda Superb II (3T) (03/08-05/15) Skoda Octavia II (1Z_) (02/04-06/13) Toyota Celica (ZZT23) (08/99-03/06) Skoda Yeti (5L) (05/09-12/17) Toyota RAV 4 II (05/00-11/05) Toyota Corolla (E12) (08/00-12/08) Volkswagen Caddy III (2KA, 2KB) (03/04-05/15) Volkswagen Beetle (5C1) (04/11-07/19) Volkswagen Golf V (1K1, 1K5, 5M1) (10/03-08/14) Volkswagen Eos (03/06-08/15) Volkswagen Jetta III (1K2) (09/04-12/13) Volkswagen Golf VI (5K1, 517, AJ5) (10/08-05/16) Volkswagen Touran I (1T1/2/3) (02/03-05/15) Volkswagen Scirocco III (137) (05/08-11/17)			
Stabilizer link		30-16 060 0074	MSL0784
<b>Notes</b>  Coupling Rod Rear Axle Left Rear Axle Right with spanner attachment  Length [mm] 141 Required quantity 2 Thread Size 1 M10x1,5 Thread Size 2 M10x1,5 replacement in pairs recommended			
<b>References</b> Toyota 48830-05020			

**Application info**

Toyota Avensis (T22) (09/97-02/03)

**Stabilizer link**

30-16 060 0075

MSL0785

**Notes**

Coupling Rod  
Front Axle Left  
Front Axle Right  
with spanner attachment

Length [mm]

360

Required quantity

2

Thread Size 1

M12X1,5

Thread Size 2

M12X1,5

replacement in pairs recommended

**References**

Daihatsu 48820-0D010

Subaru 48820-52030

Toyota 48820-0D010

Toyota 48820-0D020

Toyota 48820-52030

Toyota 48820-52040

**Application info**

Daihatsu Charade V (05/11--)

Subaru Trezia (11/10--)

Toyota Urban Cruiser (NCP11) (07/07-03/16)

Toyota Verso S (NCP12, NSP12) (11/10-10/16)

Toyota Yaris II (01/05-12/14)

Toyota Yaris III (12/10--)

**Stabilizer link**

30-16 060 0076

MSL0786

**Notes**

Coupling Rod  
Rear Axle Left  
Rear Axle Right

Length [mm]

104

Required quantity

2

Thread Size 1

M10x1,5

Thread Size 2

M10x1,5

replacement in pairs recommended

**References**

Toyota 48830-05010

Toyota 48830-05011

Toyota 48830-12060

Toyota 48830-20010

Toyota 48830-32010

Toyota 48830-32020



**Application info**

Toyota Camry (V2) (08/86-02/93)  
 Toyota Carina (T19) (02/92-09/97)  
 Toyota Celica (T18) (09/89-12/94)  
 Toyota Corolla (E10) (06/91-12/99)  
 Toyota Corolla (E9) (05/87-04/97)

Toyota Carina (T17) (12/87-06/92)  
 Toyota Celica (T16) (08/85-12/89)  
 Toyota Celica (T20) (09/93-11/99)  
 Toyota Corolla (E11) (06/95-06/02)  
 Toyota Corona (T190) (10/91-04/98)

**Stabilizer link****30-16 060 0079****MSL0789****Notes**

Coupling Rod  
 Front Axle Left  
 Front Axle Right  
 with spanner attachment

Length [mm] 63  
 Required quantity 2  
 Thread Size 1 M10x1,5  
 Thread Size 2 M10x1,5  
 replacement in pairs recommended

**References**

Lexus 48820-33010  
 Toyota 48820-20020  
 Toyota 48820-33010

Toyota 48820-02010  
 Toyota 48820-20021

**Application info**

Lexus ES (VCV10\_, VZV21\_) I, II (09/89-12/97)  
 Toyota Celica (T18) (09/89-12/94)  
 Toyota Corolla (E10) (06/91-12/99)  
 Toyota RAV 4 I (01/94-09/00)

Toyota Camry (V10) (10/82-06/98)  
 Toyota Celica (T20) (09/93-11/99)  
 Toyota Corolla (E11) (06/95-06/02)

**Stabilizer link****30-16 060 0080****MSL0790****Notes**

Coupling Rod  
 Front Axle Left  
 Front Axle Right  
 with spanner attachment

Length [mm] 285  
 Required quantity 2  
 Thread Size 1 M12X1,5  
 Thread Size 2 M12X1,5  
 replacement in pairs recommended



**References**

Hyundai 54830-0U000  
 Hyundai 54830-4L000  
 Kia 54830 2V000  
 Nissan 54618-CY00A  
 Toyota 48820-47010

Hyundai 54830-2V000  
 Kia 54830 0U000  
 Kia 54830 4L000  
 Renault 54618-CY00A

**Application info**

Hyundai Accent IV (08/10--)  
 Hyundai Veloster I (03/11-12/17)  
 Kia Cee'd II (05/12--)  
 Kia Rio III (09/10--)  
 Nissan Juke (F15) (06/10--)  
 Nissan NV200 (02/10--)  
 Nissan Sentra VII (B17) (08/12--)  
 Toyota Avensis (T25) (01/03-11/08)  
 Toyota Corolla Verso (03/04-04/09)  
 Toyota Prius II (09/03-12/09)

Hyundai Elantra V (09/10--)  
 Hyundai i30 II (06/11--)  
 Kia Cerato III (YD) (09/12--)  
 Kia Soul II (02/14--)  
 Nissan Leaf I (ZE0) (11/10--)  
 Nissan Qashqai II (J11\_) (11/13--)  
 Renault Kadjar (06/15--)  
 Toyota Corolla (E12) (08/00-12/08)  
 Toyota MR 2 (W3) (10/99-06/07)

**Stabilizer link****30-16 060 0085****MSL0795****Notes**

Coupling Rod  
 Front Axle Left  
 Front Axle Right  
 with spanner attachment

Length [mm] 260  
 Required quantity 2  
 Thread Size 1 M12X1,5  
 Thread Size 2 M12X1,5  
 replacement in pairs recommended

**References**



Lexus 48820-06040  
 Toyota 48820-06040



Lexus 48820-28050  
 Toyota 48820-28050



**Application info**



Lexus RX (GYL) III (12/08-12/15)  
 Toyota Camry (V30) (08/01-11/06)

Lexus RX (MCU) II (02/03-12/08)  
 Toyota Previa (AC\_) (02/00-02/06)

Stabilizer link		30-16 060 0089/HD	MSL1174HD
<b>Notes</b>  Carbon Neutral Coupling Rod Front Axle Left Front Axle Right  Length [mm] 245 Required quantity 2 Thread Size 1 M12x1,5 Thread Size 2 M12X1,5 replacement in pairs recommended			
<b>References</b> Subaru 20420CA000		Toyota SU003-00394	
<b>Application info</b> Subaru BRZ (06/12--) Toyota GT 86 Coupe (03/12--)		Toyota GR 86 Coupe (ZN8) (09/21--)	
Stabilizer link		30-16 060 0092/HD	MSL1188HD
<b>Notes</b>  Coupling Rod Front Axle Left Front Axle Right  Length [mm] 260 Paired article number Required quantity 2 Thread Size 1 M12x1,5 Thread Size 2 M12X1,5 replacement in pairs recommended			
<b>References</b> Suzuki 48820-42040		Toyota 48820-42040	
<b>Application info</b> Suzuki Across (A5Z_) (06/20--)		Toyota RAV 4 V (_A5_) (12/18--)	

Stabilizer link		30-16 060 0093/HD	MSL1187HD
<b>Notes</b>  Carbon Neutral Coupling Rod Rear Axle Left Rear Axle Right  Length [mm] 85 Required quantity 2 Thread Size 1 12x1,5 reinforced version replacement in pairs recommended			
<b>References</b> Toyota 48830-42030			
<b>Application info</b> Toyota RAV 4 V (_A5_) (12/18--)			
Stabilizer link		30-16 060 0096	MSL1192
<b>Notes</b>  Coupling Rod Front Axle Left Front Axle Right  Length [mm] 330 Required quantity 2 Thread Size 1 M12x1,25 Thread Size 2 M12x1,25 replacement in pairs recommended			
<b>References</b> Toyota 48820-K0010			
<b>Application info</b> Toyota Aygo III (X) (10/21--) Toyota Yaris IV (02/20--)			

Stabilizer link		31-16 060 0000/HD	MSL0271HD
<b>Notes</b>  Carbon Neutral Coupling Rod Front Axle Left  Length [mm] 55 Paired article number 31-16 060 0019/HD   MSL0286HD Required quantity 1 Thread Size 1 M10x1,5 Thread Size 2 M10x1,5 reinforced version replacement in pairs recommended			
<b>References</b> Honda 51321-S5A-003		Honda 51321-S5A-305	
<b>Application info</b> Honda CR-V II (09/01-07/07) Honda FR-V (08/04--)		Honda Civic VII (03/99-04/06) Honda Stream (05/01--)	
Stabilizer link		31-16 060 0002/HD	MSL0272HD
<b>Notes</b>  Carbon Neutral Coupling Rod Front Axle Left Front Axle Right with spanner attachment  Length [mm] 225 Required quantity 2 Thread Size 1 M10x1,5 Thread Size 2 M10x1,5 reinforced version replacement in pairs recommended			
<b>References</b> Honda 51320-SMG-E01			
<b>Application info</b> Honda Civic VIII (09/05--)			

Stabilizer link		31-16 060 0003/HD	MSL0273HD
<b>Notes</b>  Carbon Neutral Coupling Rod Front Axle Right with spanner attachment  Length [mm] 150 Paired article number 31-16 060 0004/HD   MSL0274HD Required quantity 1 Thread Size 1 M10x1,5 Thread Size 2 M10x1,5 reinforced version replacement in pairs recommended			
<b>References</b> Honda 51320-S2H-003			
<b>Application info</b> Honda HR-V I (03/99--)			
Stabilizer link		31-16 060 0004/HD	MSL0274HD
<b>Notes</b>  Carbon Neutral Coupling Rod Front Axle Left with spanner attachment  Length [mm] 150 Paired article number 31-16 060 0003/HD   MSL0273HD Required quantity 1 Thread Size 1 M10x1,5 Thread Size 2 M10x1,5 reinforced version replacement in pairs recommended			
<b>References</b> Honda 51321-S2H-003			
<b>Application info</b> Honda HR-V I (03/99--)			

**Stabilizer link**

31-16 060 0007/HD

MSL0275HD

**Notes**

Carbon Neutral  
Coupling Rod  
Rear Axle Right  
with spanner attachment

Length [mm] 90  
Paired article number 31-16 060 0008/HD | MSL0276HD  
Required quantity 1  
Thread Size 1 M10x1,5  
Thread Size 2 M10x1,5  
reinforced version  
replacement in pairs recommended

**References**

Honda 52320-S04-003

**Application info**

Honda Civic V (10/91-02/01)

Honda Civic VI (06/95-03/01)

**Stabilizer link**

31-16 060 0008/HD

MSL0276HD

**Notes**

Carbon Neutral  
Coupling Rod  
Rear Axle Left  
with spanner attachment

Length [mm] 90  
Paired article number 31-16 060 0007/HD | MSL0275HD  
Required quantity 1  
Thread Size 1 M10x1,5  
Thread Size 2 M10x1,5  
reinforced version  
replacement in pairs recommended



**References**

Honda 52321-S04-003



**Application info**

Honda Civic V (10/91-02/01)

Honda Civic VI (06/95-03/01)

Stabilizer link		31-16 060 0009/HD	MSL0277HD
<b>Notes</b>  Carbon Neutral Coupling Rod Front Axle Right with spanner attachment  Length [mm] 72 Paired article number 31-16 060 0010/HD   MSL0278HD Required quantity 1 Thread Size 1 M10x1,5 Thread Size 2 M10x1,5 reinforced version replacement in pairs recommended			
<b>References</b> Honda 51320-S84-A01			
<b>Application info</b> Honda Accord VII (03/97-09/05)			
Stabilizer link		31-16 060 0010/HD	MSL0278HD
<b>Notes</b>  Carbon Neutral Coupling Rod Front Axle Left with spanner attachment  Length [mm] 72 Paired article number 31-16 060 0009/HD   MSL0277HD Required quantity 1 Thread Size 1 M10x1,5 Thread Size 2 M10x1,5 reinforced version replacement in pairs recommended			
<b>References</b> Honda 51321-S84-A01			
<b>Application info</b> Honda Accord VII (03/97-09/05)			



Stabilizer link	31-16 060 0015/HD	MSL0282HD
<p><b>Notes</b></p> <p>Carbon Neutral Coupling Rod Rear Axle Right with spanner attachment</p> <p>Length [mm] 115</p> <p>Paired article number 31-16 060 0017/HD   MSL0284HD</p> <p>Required quantity 1</p> <p>Thread Size 1 M10x1,5</p> <p>Thread Size 2 M10x1,5</p> <p>reinforced version</p> <p>replacement in pairs recommended</p>		
<p><b>References</b></p> <p>Honda 52320-S84-A01</p> <p>Honda 52320-SDA-A01</p>		
<p><b>Application info</b></p> <p>Honda Accord VII (03/97-09/05)</p> <p>Honda Accord VIII (09/02--)</p>		
Stabilizer link	31-16 060 0017/HD	MSL0284HD
<p><b>Notes</b></p> <p>Carbon Neutral Coupling Rod Rear Axle Left with spanner attachment</p> <p>Length [mm] 115</p> <p>Paired article number 31-16 060 0015/HD   MSL0282HD</p> <p>Required quantity 1</p> <p>Thread Size 1 M10x1,5</p> <p>Thread Size 2 M10x1,5</p> <p>reinforced version</p> <p>replacement in pairs recommended</p>		
<p><b>References</b></p> <p>Honda 52325-S84-A01</p> <p>Honda 52325-SDA-A01</p>		
<p><b>Application info</b></p> <p>Honda Accord VII (03/97-09/05)</p> <p>Honda Accord VIII (09/02--)</p>		

**Stabilizer link****31-16 060 0019/HD****MSL0286HD****Notes**

Carbon Neutral  
Coupling Rod  
Front Axle Right

Length [mm] 55  
Paired article number 31-16 060 0000/HD | MSL0271HD  
Required quantity 1  
Thread Size 1 M10x1,5  
Thread Size 2 M10x1,5  
reinforced version  
replacement in pairs recommended

**References**

Honda 51320-S5A-003

**Application info**

Honda CR-V II (09/01-07/07)  
Honda FR-V (08/04--)

Honda Civic VII (03/99-04/06)  
Honda Stream (05/01--)

**Stabilizer link****31-16 060 0021/HD****MSL0287HD****Notes**

Carbon Neutral  
Coupling Rod  
Front Axle Left

Length [mm] 80  
Paired article number 31-16 060 0022/HD | MSL0288HD  
Required quantity 1  
Thread Size 1 M10x1,5  
Thread Size 2 M10x1,5  
reinforced version  
replacement in pairs recommended

**References**

Honda 51321-SDA-A02  
Honda 51321-SDA-A04

Honda 51321-SDA-A03  
Honda 51321-SEA-E01

**Application info**

Honda Accord VIII (09/02--)

DRIVER'S BEST FRIEND

MEYLE

**Stabilizer link**

31-16 060 0022/HD

MSL0288HD

**Notes**

Carbon Neutral  
Coupling Rod  
Front Axle Right

Length [mm] 80  
Paired article number 31-16 060 0021/HD | MSL0287HD  
Required quantity 1  
Thread Size 1 M10x1,5  
Thread Size 2 M10x1,5  
reinforced version  
replacement in pairs recommended



**References**

Honda 51320-SDA-A02  
Honda 51320-SDA-A04

Honda 51320-SDA-A03  
Honda 51320-SEA-E01

**Application info**

Honda Accord VIII (09/02--)

**Stabilizer link**

31-16 060 0023/HD

MSL0289HD

**Notes**

Carbon Neutral  
Coupling Rod  
Front Axle Right  
with spanner attachment

Length [mm] 300  
Paired article number 31-16 060 0024/HD | MSL0290HD  
Required quantity 1  
Thread Size 1 M10x1,5  
Thread Size 2 M10x1,5  
reinforced version  
replacement in pairs recommended



**References**

Honda 51320-SAA-003

Honda 51320-SAD-P01

**Application info**

Honda Jazz II (06/01-12/08)

**Stabilizer link**

31-16 060 0024/HD

MSL0290HD

**Notes**

Carbon Neutral  
Coupling Rod  
Front Axle Left  
with spanner attachment

Length [mm] 300  
Paired article number 31-16 060 0023/HD | MSL0289HD  
Required quantity 1  
Thread Size 1 M10x1,5  
Thread Size 2 M10x1,5  
reinforced version  
replacement in pairs recommended



**References**

Honda 51321-SAA-003 Honda 51321-SAD-P01  
Honda 51321-SEL-T01

**Application info**

Honda Jazz II (06/01-12/08)

**Stabilizer link**

31-16 060 0025/HD

MSL0291HD

**Notes**

Carbon Neutral  
Coupling Rod  
Rear Axle Right  
with spanner attachment

Length [mm] 73  
Paired article number 31-16 060 0026/HD | MSL0292HD  
Required quantity 1  
Thread Size 1 M10x1,5  
Thread Size 2 M10x1,5  
reinforced version  
replacement in pairs recommended

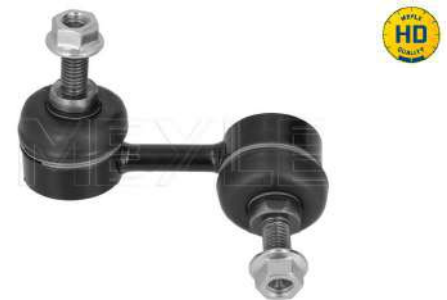

**References**

Honda 52320-S5A-013 Honda 52320-S5T-J01

**Application info**

Honda Civic VII (03/99-04/06)

**Stabilizer link**

31-16 060 0026/HD

MSL0292HD

**Notes**

Carbon Neutral  
Coupling Rod  
Rear Axle Left  
with spanner attachment

Length [mm]

73

Paired article number

31-16 060 0025/HD | MSL0291HD

Required quantity

1

Thread Size 1

M10x1,5

Thread Size 2

M10x1,5

reinforced version

replacement in pairs recommended

**References**

Honda 52321-S5A-013

Honda 52321-S5T-J01

**Application info**

Honda Civic VII (03/99-04/06)

**Stabilizer link**

31-16 060 0047/HD

MSL0605HD

**Notes**

Carbon Neutral  
Coupling Rod  
Front Axle Right

Length [mm]

71.5

Paired article number

31-16 060 0048/HD | MSL0606HD

Required quantity

1

Thread Size 1

M10x1,5

Thread Size 2

M10x1,5

reinforced version

replacement in pairs recommended

**References**

Honda 51320-SNA-A02

**Application info**

Honda Civic VII (03/99-04/06)

Honda Civic VIII (09/05--)

**Stabilizer link**

31-16 060 0048/HD

MSL0606HD

**Notes**

Carbon Neutral  
Coupling Rod  
Front Axle Left

Length [mm] 71.5  
Paired article number 31-16 060 0047/HD | MSL0605HD  
Required quantity 1  
Thread Size 1 M10X1,5  
Thread Size 2 M10X1,5  
reinforced version  
replacement in pairs recommended

**References**

Honda 51321-SNA-A02

**Application info**

Honda Civic VII (03/99-04/06)

Honda Civic VIII (09/05--)

**Stabilizer link**

31-16 060 0049/HD

MSL0601HD

**Notes**

Carbon Neutral  
Coupling Rod  
Front Axle Left  
Front Axle Right  
with spanner attachment

Length [mm] 325  
Required quantity 2  
Thread Size 1 M10x1,5  
Thread Size 2 M10X1,5  
reinforced version  
replacement in pairs recommended

**References**



Honda 51320-TF0-003

**Application info**

Honda CR-Z (06/10--)

Honda Insight II (04/09--)

Honda Jazz III (10/07--)

Stabilizer link		31-16 060 0050/HD	MSL0607HD
<b>Notes</b>  Carbon Neutral Coupling Rod Front Axle Right  Length [mm] 70 Paired article number 31-16 060 0053/HD   MSL0608HD Required quantity 1 Thread Size 1 M10x1,5 Thread Size 2 M10x1,5 reinforced version replacement in pairs recommended			
<b>References</b> Honda 51320-SED-003		Honda 51320-SED-013	
<b>Application info</b> Honda Accord VIII (09/02-- )			
Stabilizer link		31-16 060 0053/HD	MSL0608HD
<b>Notes</b>  Carbon Neutral Coupling Rod Front Axle Left  Length [mm] 70 Paired article number 31-16 060 0050/HD   MSL0607HD Required quantity 1 Thread Size 1 M10x1,5 Thread Size 2 M10x1,5 reinforced version replacement in pairs recommended			
<b>References</b> Honda 51321-SED-003		Honda 51321-SED-013	
<b>Application info</b> Honda Accord VIII (09/02-- )			

**Stabilizer link**

31-16 060 0054

MSL0588

**Notes**

Coupling Rod  
Front Axle Right

Length [mm] 320

Paired article number 31-16 060 0055 | MSL0589

Required quantity 1

Thread Size 1 M10x1,25

Thread Size 2 M10X1,25

replacement in pairs recommended

**References**

Honda 51320-SAA-J01

**Application info**

Honda Jazz II (06/01-12/08)

**Stabilizer link**

31-16 060 0055

MSL0589

**Notes**

Coupling Rod  
Front Axle Left

Length [mm] 320

Paired article number 31-16 060 0054 | MSL0588

Required quantity 1

Thread Size 1 M10X1,25

Thread Size 2 M10X1,25

replacement in pairs recommended



**References**

Honda 51321-SAA-J01



**Application info**

Honda Jazz II (06/01-12/08)



Stabilizer link		31-16 060 0060	MSL0680
<b>Notes</b>  Coupling Rod Rear Axle Right with spanner attachment  Length [mm] 89 Paired article number 31-16 060 0061   MSL0912 Required quantity 1 Thread Size 1 M10x1,5 Thread Size 2 M10X1,5 replacement in pairs recommended			
<b>References</b> Honda 52320S-9A003			
<b>Application info</b> Honda CR-V II (09/01-07/07)			
Stabilizer link		31-16 060 0061	MSL0912
<b>Notes</b>  Coupling Rod Rear Axle Left with spanner attachment  Length [mm] 89 Paired article number 31-16 060 0060   MSL0680 Required quantity 1 Thread Size 1 M10x1,5 Thread Size 2 M10X1,5 replacement in pairs recommended			
<b>References</b> Honda 52321S-9A003			
<b>Application info</b> Honda CR-V II (09/01-07/07)			

<b>Stabilizer link</b>		31-16 060 0062	MSL0796
<b>Notes</b> Coupling Rod Rear Axle Left Rear Axle Right  Length [mm] 125 Required quantity 2 Thread Size 1 M10x1,5 Thread Size 2 M10x1,5 replacement in pairs recommended			
<b>References</b> Honda 52320-SED-003			
<b>Application info</b> Honda Accord VIII (09/02--) 			
<b>Stabilizer link</b>		31-16 060 0063	MSL0797
<b>Notes</b> Coupling Rod Front Axle Left  Length [mm] 55 Paired article number 31-16 060 0064   MSL0798 Required quantity 1 Thread Size 1 M10x1,5 Thread Size 2 M10x1,5 replacement in pairs recommended			
<b>References</b> Honda 51321-S5A-003                                  Honda 51321-S5A-305			
<b>Application info</b> Honda CR-V II (09/01-07/07)                                  Honda Civic VII (03/99-04/06) Honda FR-V (08/04--) Honda Stream (05/01--)			

Stabilizer link		31-16 060 0064	MSL0798
<b>Notes</b>  Coupling Rod Front Axle Right  Length [mm] 55 Paired article number 31-16 060 0063   MSL0797 Required quantity 1 Thread Size 1 M10x1,5 Thread Size 2 M10x1,5 replacement in pairs recommended			
<b>References</b> Honda 51320-S5A-003			
<b>Application info</b> Honda CR-V II (09/01-07/07)      Honda Civic VII (03/99-04/06) Honda FR-V (08/04--))      Honda Stream (05/01--))			
Stabilizer link		31-16 060 0070	MSL0804
<b>Notes</b>  Coupling Rod Rear Axle Right with spanner attachment  Length [mm] 73 Paired article number 31-16 060 0071   MSL0805 Required quantity 1 Thread Size 1 M10x1,5 Thread Size 2 M10x1,5 replacement in pairs recommended			
<b>References</b> Honda 52320-S5A-013      Honda 52320-S5T-J01			
<b>Application info</b> Honda Civic VII (03/99-04/06)			

**Stabilizer link**

31-16 060 0071

MSL0805

**Notes**

Coupling Rod  
Rear Axle Left  
with spanner attachment

Length [mm]

73

Paired article number

31-16 060 0070 | MSL0804

Required quantity

1

Thread Size 1

M10x1,5

Thread Size 2

M10x1,5

replacement in pairs recommended

**References**

Honda 52321-S5A-013

Honda 52321-S5T-J01

**Application info**

Honda Civic VII (03/99-04/06)

**Stabilizer link**

31-16 060 0076/HD

MSL1021HD

**Notes**

Carbon Neutral  
Coupling Rod  
Front Axle Right

Length [mm]

310

Paired article number

31-16 060 0077/HD | MSL1022HD

Required quantity

1

Thread Size 1

M10X1,5

Thread Size 2

M10X1,5

reinforced version

replacement in pairs recommended

**References**

Honda 51320-T5A-003

**Application info**

Honda Jazz IV (09/13--)

**Stabilizer link** **31-16 060 0077/HD** **MSL1022HD**

<b>Notes</b>	Carbon Neutral Coupling Rod Front Axle Left	
Length [mm]	310	
Paired article number	31-16 060 0076/HD   MSL1021HD	
Required quantity	1	
Thread Size 1	M10X1,5	
Thread Size 2	M10X1,5	
reinforced version		
replacement in pairs recommended		

**References**  
 Honda 51325-T5A-003

**Application info**  
 Honda Jazz IV (09/13--)

**Stabilizer link** **31-16 060 0078/HD** **MSL1168HD**

<b>Notes</b>	Carbon Neutral Coupling Rod Front Axle Left Front Axle Right	
Length [mm]	345	
Required quantity	2	
Thread Size 1	M10x1,5	
Thread Size 2	M10X1,5	
reinforced version		
replacement in pairs recommended		

**References**  
 Honda 51320-TBA-A01 Honda 51320-TBA-A02

**Application info**  
 Honda CR-V V (12/16--)  
Honda Civic X (09/15--)

**Stabilizer link**

31-16 060 0079/HD

MSL1169HD

**Notes**

Carbon Neutral  
Coupling Rod  
Rear Axle Left  
Rear Axle Right

Inner Diameter [mm]

8.1

Length [mm]

60

Required quantity

2

Thread Size 1

M10 X 1,5

reinforced version

replacement in pairs recommended

**References**

Honda 52320-TBA-A01

**Application info**

Honda Civic X (09/15--)

**Suspension Kit**

116 610 0000/HD

MCR0097HD

**Notes**

Carbon Neutral  
Front Axle Right  
for control arm  
with ball joint  
with rubber mount

Paired article number

116 610 0001/HD | MCR0098HD

Replace in pairs only

Required quantity

1

reinforced version



**References**

Audi 191 407 182	Audi 1J0 407 151 A
Audi 1J0 407 151 B	Audi 1J0 407 151 C
Audi 1J0 407 181	Audi 1J0 407 181 A
Audi 1J0 407 366 A	Audi 1J0 407 366 C
Audi 1J0 407 366 D	Audi 1J0 407 366 J
Audi 357 407 182	Seat 191 407 182
Seat 1J0 407 151 C	Seat 1J0 407 181
Seat 1J0 407 181 A	Seat 1J0 407 182
Seat 1J0 407 366 C	Seat 1J0 407 366 H
Seat 1J0 407 366 J	Seat 357 407 182
Skoda 191 407 182	Skoda 1J0 407 151 C
Skoda 1J0 407 181	Skoda 1J0 407 181 A
Skoda 1J0 407 182	Skoda 1J0 407 366 C
Skoda 1J0 407 366 D	Skoda 1J0 407 366 H
Skoda 1J0 407 366 J	Skoda 1J0 422 366 C
Skoda 357 407 182	Volkswagen 191 407 182
Volkswagen 1J0 407 151 B	Volkswagen 1J0 407 151 C
Volkswagen 1J0 407 181	Volkswagen 1J0 407 181 A
Volkswagen 1J0 407 182	Volkswagen 1J0 407 366 A
Volkswagen 1J0 407 366 C	Volkswagen 1J0 407 366 D
Volkswagen 1J0 407 366 H	Volkswagen 1J0 407 366 J
Volkswagen 357 407 182	Volkswagen (FAW) 1J0 407 151 C
Volkswagen (FAW) 1J0 407 181	Volkswagen (FAW) 1J0 407 366 C
Volkswagen (FAW) 357 407 182	Volkswagen (FAW) L1J0 407 181
Volkswagen (FAW) L357 407 182	

**Application info**

Audi A3 I (8L_) (09/96-09/06)	Seat Leon I / Toledo II (1M_) (10/98-06/06)
Skoda Octavia I (1U_) (09/96-12/10)	Volkswagen Bora (1J2, 1J6) (10/98-12/13)
Volkswagen Golf IV (1J1, 1J5) (08/97-06/14)	Volkswagen New Beetle (1Y7, 9C1, 1C1) (01/98-12/11)
Volkswagen Polo (6R_) (03/09--)	

## Suspension Kit

116 610 0001/HD

MCR0098HD

## Notes

Carbon Neutral  
Front Axle Left  
for control arm  
with ball joint  
with rubber mount

Paired article number

116 610 0000/HD | MCR0097HD

Replace in pairs only

Required quantity

1

reinforced version



## References

Audi 191 407 182

Audi 1J0 407 151 A

Audi 1J0 407 151 B

Audi 1J0 407 151 C

Audi 1J0 407 181

Audi 1J0 407 181 A

Audi 1J0 407 365 A

Audi 1J0 407 365 C

Audi 1J0 407 365 D

Audi 1J0 407 365 J

Audi 357 407 182

Seat 191 407 182

Seat 1J0 407 151 C

Seat 1J0 407 181

Seat 1J0 407 181 A

Seat 1J0 407 182

Seat 1J0 407 365 C

Seat 1J0 407 365 H

Seat 1J0 407 365 J

Seat 357 407 182

Skoda 191 407 182

Skoda 1J0 407 151 C

Skoda 1J0 407 181

Skoda 1J0 407 181 A

Skoda 1J0 407 182

Skoda 1J0 407 365 C

Skoda 1J0 407 365 D

Skoda 1J0 407 365 H

Skoda 1J0 407 365 J

Skoda 357 407 182

Volkswagen 191 407 182

Volkswagen 1J0 407 151 B

Volkswagen 1J0 407 151 C

Volkswagen 1J0 407 181

Volkswagen 1J0 407 181 A

Volkswagen 1J0 407 182

Volkswagen 1J0 407 365 A

Volkswagen 1J0 407 365 C

Volkswagen 1J0 407 365 D

Volkswagen 1J0 407 365 H

Volkswagen 1J0 407 365 J

Volkswagen 357 407 182

Volkswagen (FAW) 1J0 407 151 C

Volkswagen (FAW) 1J0 407 181

Volkswagen (FAW) 1J0 407 365 C

Volkswagen (FAW) 357 407 182

Volkswagen (FAW) L1J0 407 181

Volkswagen (FAW) L357 407 182

## Application info

Audi A3 I (8L\_) (09/96-09/06)

Seat Leon I / Toledo II (1M\_) (10/98-06/06)

Skoda Octavia I (1U\_) (09/96-12/10)

Volkswagen Bora (1J2, 1J6) (10/98-12/13)

Volkswagen Golf IV (1J1, 1J5) (08/97-06/14)

Volkswagen New Beetle (1Y7, 9C1, 1C1) (01/98-12/11)

Volkswagen Polo (6R\_) (03/09--)



**Suspension Kit**

116 610 0002

MCR0099

**Notes**

Front Axle Left  
 Front Axle Right  
 for control arm  
 with ball joint  
 with rubber mount

Required quantity  
 replacement in pairs recommended

2

**References**

Volkswagen 2H0 407 151 A  
 Volkswagen 2H0 407 182 A  
 Volkswagen 2H0 412 333 A  
 Volkswagen 7H0 407 151 F  
 Volkswagen 7H0 407 152 F

Volkswagen 2H0 407 152 A  
 Volkswagen 2H0 407 183 A  
 Volkswagen 7H0 407 151 B  
 Volkswagen 7H0 407 152 B  
 Volkswagen 7H0 407 183

**Application info**

Volkswagen Amarok I (09/10--)

**Suspension Kit**

16-16 610 0001

MCR0100

**Notes**

Front Axle Left  
 Front Axle Right  
 with ball joint  
 with rubber mount

Required quantity  
 replacement in pairs recommended

2

**References**

Renault 6025307746  
 Renault 7700413494  
 Renault 7700823097  
 Renault 7700824042

Renault 7700413493  
 Renault 7700822503  
 Renault 7700823098

**Application info**

Renault Laguna I (11/93-08/02)

**Suspension Kit** **16-16 610 0002** **MCR0101**

**Notes**

Front Axle Right  
for control arm  
with ball joint  
with rubber mount

Paired article number 16-16 610 0003 | MCR0102

Required quantity 1

replacement in pairs recommended



**References**

- |                               |                               |
|-------------------------------|-------------------------------|
| Mercedes-Benz 415 330 02 00   | Mercedes-Benz 415 330 03 00   |
| Mercedes-Benz A 415 330 02 00 | Mercedes-Benz A 415 330 03 00 |
| Renault 545041876R            | Renault 545044506R            |
| Renault 545058191R            | Renault 8200041166            |
| Renault 8200242025            | Renault 8200586561            |
| Renault 8200586564            | Renault 8200586567            |
| Renault 8200586570            |                               |

**Application info**

- |  |                             |
|--|-----------------------------|
| Mercedes-Benz BM 415 (Citan) (11/12--) | Renault Kangoo II (02/08--) |
|--|-----------------------------|

**Suspension Kit** **16-16 610 0002/HD** **MCR0101HD**

**Notes**

Carbon Neutral  
Front Axle Left  
Front Axle Right  
with ball joint  
with rubber mount

Replace in pairs only

Required quantity 2

reinforced version



**References**

GENERAL MOTORS 91166461  
 GENERAL MOTORS 93851117  
 GENERAL MOTORS 93858141  
 GENERAL MOTORS 95523257  
 Nissan 54502-00Q0A  
 Nissan 54502-00QAA  
 Nissan 54503-00Q0A  
 Nissan 54503-00QAA  
 Opel 44 08 958  
 Opel 44 12 934  
 Opel 44 18 223  
 Renault 8200002869  
 Renault 8200054003  
 Renault 8200247898  
 Renault 8200565072  
 Vauxhall 44 08 958  
 Vauxhall 44 12 936

GENERAL MOTORS 91166462  
 GENERAL MOTORS 93851118  
 GENERAL MOTORS 93858142  
 GENERAL MOTORS 95523358  
 Nissan 54502-00Q0B  
 Nissan 54502-00QAB  
 Nissan 54503-00Q0B  
 Nissan 54503-00QAB  
 Opel 44 08 959  
 Opel 44 12 936  
 Opel 44 18 224  
 Renault 8200049624  
 Renault 8200054006  
 Renault 8200247900  
 Renault 8200565079  
 Vauxhall 44 12 934

**Application info**

Nissan Primastar I (X83) (03/01--)  
 Renault Trafic II (03/01--)

Opel Vivaro A (08/01--)  
 Vauxhall Vivaro A (08/01-07/14)

**Suspension Kit**

16-16 610 0003

MCR0102

**Notes**

Front Axle Left  
 for control arm  
 with ball joint  
 with rubber mount

Paired article number  
 Required quantity  
 replacement in pairs recommended

16-16 610 0002 | MCR0101  
 1



**References**

Mercedes-Benz 415 330 02 00  
 Mercedes-Benz A 415 330 02 00  
 Renault 545041876R  
 Renault 545058191R  
 Renault 8200242025  
 Renault 8200586564  
 Renault 8200586570

Mercedes-Benz 415 330 03 00  
 Mercedes-Benz A 415 330 03 00  
 Renault 545044506R  
 Renault 8200041166  
 Renault 8200586561  
 Renault 8200586567

**Application info**

Mercedes-Benz BM 415 (Citan) (11/12--)

Renault Kangoo II (02/08--)

**Suspension Kit**

16-16 610 0003/HD

MCR0102HD

**Notes**

Carbon Neutral  
Front Axle Left  
Front Axle Right  
for control arm  
with ball joint  
with rubber mount

Replace in pairs only  
Required quantity  
reinforced version

2



**References**

Renault 401606676R  
Renault 7701476576  
Renault 8200002868  
Renault 8200026654  
Renault 8200273728  
Renault 8200389134  
Renault 8200452715  
Renault 8200602612

Renault 6040002105  
Renault 7701478029  
Renault 8200002869  
Renault 8200026655  
Renault 8200273729  
Renault 8200389135  
Renault 8200452716  
Renault 8200602613

**Application info**

Renault Espace IV (11/02--)  
Renault Vel Satis (06/02--)

Renault Laguna II (03/01-12/07)

**Suspension Kit**

16-16 610 0004

MCR0103

**Notes**

Front Axle Left  
Front Axle Right  
for control arm  
with ball joint  
with rubber mount

Required quantity  
replacement in pairs recommended

2



DRIVER'S BEST FRIEND

MEYLE

**References**

Renault 8200041166  
Renault 8200255760

Renault 8200242025  
Renault 8200255761

**Application info**

Renault Mégane II (07/01--)

**Suspension Kit**

16-16 610 0005

MCR0104

**Notes**

Front Axle Left  
Front Axle Right  
for control arm  
with ball joint  
with rubber mount  
2

Required quantity  
replacement in pairs recommended



**References**

GENERAL MOTORS 4418212  
 GENERAL MOTORS 9109853  
 GENERAL MOTORS 9109941  
 GENERAL MOTORS 9112048  
 GENERAL MOTORS 9160393  
 GENERAL MOTORS 93192690  
 Nissan 40160-00QAD  
 Nissan 54500-00QAC  
 Nissan 54500-00QAE  
 Nissan 54501-00QAC  
 Nissan 54501-00QAE  
 Opel 44 01 853  
 Opel 44 01 941  
 Opel 44 04 048  
 Opel 44 18 213  
 Opel 45 00 093  
 Renault 7700302119  
 Renault 7700309190  
 Renault 7701302119  
 Renault 8200256944  
 Renault 8200270058  
 Renault 8200767825  
 Vauxhall 44 01 853  
 Vauxhall 44 01 941  
 Vauxhall 44 04 048  
 Vauxhall 44 18 213

GENERAL MOTORS 9109852  
 GENERAL MOTORS 9109940  
 GENERAL MOTORS 9112047  
 GENERAL MOTORS 9160392  
 GENERAL MOTORS 93192689  
 Nissan 40160-00QAC  
 Nissan 54500-00Q0C  
 Nissan 54500-00QAD  
 Nissan 54501-00Q0C  
 Nissan 54501-00QAD  
 Opel 44 01 852  
 Opel 44 01 940  
 Opel 44 04 047  
 Opel 44 18 212  
 Opel 45 00 092  
 Renault 7700302118  
 Renault 7700309189  
 Renault 7701302118  
 Renault 8200256944  
 Renault 8200270055  
 Renault 8200767822  
 Vauxhall 44 01 852  
 Vauxhall 44 01 940  
 Vauxhall 44 04 047  
 Vauxhall 44 18 212  
 Vauxhall 45 00 092

**Application info**

Nissan Interstar I (X70) (04/02--)  
 Renault Master II (03/98--)

Opel Movano A (07/98--)  
 Vauxhall Movano Mk I (10/98-12/10)

**Suspension Kit**

16-16 610 0006/HD

MCR0105HD

**Notes**

Carbon Neutral  
 Front Axle Left  
 Front Axle Right  
 for control arm  
 with ball joint  
 with rubber mount

Replace in pairs only  
 Required quantity  
 reinforced version

2



**References**

Renault 7700436302  
 Renault 7700781034  
 Renault 7700789478  
 Renault 7700818052  
 Renault 7700831369  
 Renault 7701462182  
 Renault 7701468883  
 Renault 8200610363  
 Renault 8200737134

Renault 7700436303  
 Renault 7700781035  
 Renault 7700818051  
 Renault 7700831368  
 Renault 7700840741  
 Renault 7701468411  
 Renault 7701472038  
 Renault 8200651163  
 Renault 8200737135

**Application info**

Renault Mégane I / Scénic I (08/95-07/10)

Renault R 19 (01/88-08/03)

**Suspension Kit****16-16 610 0007/HD****MCR0106HD****Notes**

Carbon Neutral  
 Front Axle Left  
 Front Axle Right  
 for control arm  
 with ball joint  
 with rubber mount

Replace in pairs only  
 Required quantity  
 reinforced version

2

**References**

Nissan 54500-00Q0D  
 Nissan 54500-00Q0M  
 Nissan 54500-00QAH  
 Nissan 54501-00Q0L  
 Nissan 54560-00Q0A  
 Renault 7700310809  
 Renault 7700313944  
 Renault 7700424459  
 Renault 7700425033  
 Renault 7700425228  
 Renault 8200197179  
 Renault 8200737123  
 Renault 8200942407

Nissan 54500-00Q0J  
 Nissan 54500-00Q1A  
 Nissan 54501-00Q0G  
 Nissan 54501-00QAH  
 Nissan 54560-00QAB  
 Renault 7700310810  
 Renault 7700313945  
 Renault 7700425032  
 Renault 7700425227  
 Renault 7701468883  
 Renault 8200197187  
 Renault 8200737129  
 Renault 8200942408

**Application info**

Nissan Kubistar (08/03--)  
 Renault Kangoo I (08/97--)

Renault Clio II / Thalia (02/98--)

**Suspension Kit** **16-16 610 0008** **MCR0107**

**Notes**

Front Axle Left  
 Front Axle Right  
 for control arm  
 with ball joint  
 with rubber mount

Required quantity  
 replacement in pairs recommended



**References**

Renault 401609060R  
 Renault 545006560R  
 Renault 545009207R  
 Renault 545014055R  
 Renault 545016838R  
 Renault 545019389R

Renault 545000399R  
 Renault 545008682R  
 Renault 545009795R  
 Renault 545016101R  
 Renault 545018194R

**Application info**

Renault Fluence (02/10--)  
 Renault Scénic III (12/08--)

Renault Megane III (11/08--)

**Suspension Kit** **16-16 610 0009** **MCR0108**

**Notes**

Front Axle Left  
 Front Axle Right  
 for control arm  
 with ball joint  
 with rubber mount

Required quantity  
 replacement in pairs recommended





**References**

Dacia 401602308R  
 Dacia 545001535R  
 Dacia 545011697R  
 Dacia 545016746R  
 Dacia 545501225R  
 Renault 545000138R  
 Renault 545006542R  
 Renault 545012815R  
 Renault 545019969R  
 Renault 545602788R

Dacia 545000138R  
 Dacia 545006542R  
 Dacia 545012815R  
 Dacia 545019969R  
 Dacia 545602788R  
 Renault 545001535R  
 Renault 545011697R  
 Renault 545016746R  
 Renault 545501225R

**Application info**

Dacia Duster I (04/10--)

Renault Duster I (01/11--)

**Suspension Kit**

16-16 610 0011

MCR0110

**Notes**

Front Axle Left  
 Front Axle Right  
 for control arm  
 with ball joint  
 with rubber mount  
 2

Required quantity  
 replacement in pairs recommended



**References**

GENERAL MOTORS 91166461  
 GENERAL MOTORS 93851118  
 GENERAL MOTORS 93858864  
 GENERAL MOTORS 93862135  
 Nissan 40160-00Q0A  
 Nissan 54502-00Q0A  
 Nissan 54502-00Q0C  
 Nissan 54502-00QAA  
 Nissan 54503-00Q0B  
 Nissan 54503-00Q0D  
 Opel 44 08 959  
 Opel 44 17 177  
 Opel 44 18 225  
 Opel 44 21 646  
 Opel 44 31 869  
 Renault 545044506R  
 Renault 545058162R  
 Renault 7701477385  
 Renault 8200041166  
 Renault 8200395007  
 Renault 8200586561  
 Renault 8200586570  
 Renault 8200626961  
 Renault 8200876657  
 Vauxhall 44 08 959  
 Vauxhall 44 17 177  
 Vauxhall 44 31 869

GENERAL MOTORS 93161884  
 GENERAL MOTORS 93853464  
 GENERAL MOTORS 93858865  
 GENERAL MOTORS 93862136  
 Nissan 40160-00Q0C  
 Nissan 54502-00Q0B  
 Nissan 54502-00Q0D  
 Nissan 54503-00Q0A  
 Nissan 54503-00Q0C  
 Nissan 54503-00QAA  
 Opel 44 12 936  
 Opel 44 17 178  
 Opel 44 18 226  
 Opel 44 21 647  
 Renault 545041876R  
 Renault 545049296R  
 Renault 545058191R  
 Renault 8200002869  
 Renault 8200049624  
 Renault 8200395034  
 Renault 8200586567  
 Renault 8200626959  
 Renault 8200667278  
 Renault 8200876659  
 Vauxhall 44 12 936  
 Vauxhall 44 17 178

**Application info**

Nissan Primastar I (X83) (03/01--)  
 Renault Trafic II (03/01--)

Opel Vivaro A (08/01--)  
 Vauxhall Vivaro A (08/01-07/14)

**Suspension Kit**

16-16 610 0012

MCR0111

**Notes**

Front Axle Left  
 Front Axle Right  
 for control arm  
 with ball joint  
 with rubber mount  
 2

Required quantity  
 replacement in pairs recommended



**References**

- |                         |                         |
|-------------------------|-------------------------|
| Chevrolet 25995128      | Chevrolet 25995129      |
| Chevrolet 96626235      | Chevrolet 96626236      |
| Chevrolet 96809676      | Chevrolet 96810753      |
| Chevrolet 96810754      | Chevrolet 96819161      |
| Chevrolet 96819162      | Chevrolet 96852964      |
| GENERAL MOTORS 20946157 | GENERAL MOTORS 20946158 |
| GENERAL MOTORS 20946159 | GENERAL MOTORS 25995127 |
| GENERAL MOTORS 25995128 | GENERAL MOTORS 25995129 |
| GENERAL MOTORS 96626235 | GENERAL MOTORS 96626236 |
| GENERAL MOTORS 96809676 | GENERAL MOTORS 96819161 |
| GENERAL MOTORS 96819162 | Opel 47 17 777          |
| Opel 48 02 540          | Opel 48 02 541          |
| Opel 48 02 543          | Opel 48 06 300          |
| Opel 48 06 301          | Opel 48 10 831          |
| Opel 48 10 870          | Opel 48 12 870          |
| Opel 48 17 776          | Opel 48 17 777          |
| Opel 48 17 778          | Opel 48 17 869          |
| Opel 48 20 932          | Vauxhall 47 17 777      |
| Vauxhall 48 02 540      | Vauxhall 48 02 541      |
| Vauxhall 48 02 543      | Vauxhall 48 06 300      |
| Vauxhall 48 06 301      | Vauxhall 48 10 831      |
| Vauxhall 48 10 870      | Vauxhall 48 12 870      |
| Vauxhall 48 17 776      | Vauxhall 48 17 778      |
| Vauxhall 48 17 869      |                         |

**Application info**

- |                               |                       |
|-------------------------------|-----------------------|
| Chevrolet Captiva I (06/06--) | Opel Antara (05/06--) |
| Vauxhall Antara (08/06--)     |                       |

**Suspension Kit**

16-16 610 0013

MCR0112

**Notes**

Front Axle Left  
 Front Axle Right  
 for control arm  
 with ball joint  
 with rubber mount  
 2

Required quantity  
 replacement in pairs recommended



**References**

- |                    |                    |
|--------------------|--------------------|
| Renault 545041876R | Renault 545044506R |
| Renault 545046817R | Renault 545048506R |
| Renault 545049968R | Renault 545050399R |
| Renault 545050510R | Renault 545052354R |
| Renault 545055711R | Renault 545058191R |
| Renault 8200041166 | Renault 8200242025 |
| Renault 8200586561 | Renault 8200586564 |
| Renault 8200586567 | Renault 8200586570 |

**Application info**

- |                           |                       |
|---------------------------|-----------------------|
| Renault Clio IV (11/12--) | Renault Zoe (06/12--) |
|---------------------------|-----------------------|

**Suspension Kit**

16-16 610 0015 MCR0113

**Notes**

Front Axle Left  
 Front Axle Right  
 for control arm  
 with ball joint  
 with rubber mount

Required quantity  
 replacement in pairs recommended

2







**References**

- |                    |                    |
|--------------------|--------------------|
| Renault 545003037R | Renault 545017775R |
| Renault 545040131R | Renault 545053170R |
| Renault 8200298454 | Renault 8200298455 |
| Renault 8200457208 | Renault 8200457209 |
| Renault 8200679063 | Renault 8200679067 |

**Application info**

- |                             |                                 |
|-----------------------------|---------------------------------|
| Renault Mégane II (07/01--) | Renault Scénic II (06/03-07/10) |
|-----------------------------|---------------------------------|

Suspension Kit		216 610 0003	MCR0114
<p><b>Notes</b></p> <p>Required quantity replacement in pairs recommended</p>	<p>Front Axle Left Front Axle Right for control arm with ball joint with rubber mount</p> <p>2</p>		
<p><b>References</b></p> <p>Peugeot 96 707 714 80</p>		<p>Peugeot 96 707 720 80</p>	
<p><b>Application info</b></p> <p>Peugeot 208 I (03/12--)</p>			
Suspension Kit		216 610 0004	MCR0115
<p><b>Notes</b></p> <p>Required quantity replacement in pairs recommended</p>	<p>Front Axle Left Front Axle Right for control arm with ball joint with rubber mount</p> <p>2</p>		
<p><b>References</b></p> <p>Fiat 52011612 Fiat 52056673 Fiat 52082896 Fiat K68326642AA</p>		<p>Fiat 52011614 Fiat 52056674 Fiat 52082897 Fiat K68385373AA</p>	
<p><b>Application info</b></p> <p>Fiat Tipo (356) (10/15--)</p>			

Suspension Kit		216 610 0006/HD	MCR0070HD
<p><b>Notes</b></p> <p>Carbon Neutral Front Axle Left Front Axle Right for control arm with ball joint with rubber mount</p> <p>Replace in pairs only Required quantity 2</p>			
<p><b>References</b></p> <p>Iveco 5 0033 4716</p>		<p>Iveco 5 0033 4717</p>	
<p><b>Application info</b></p> <p>Iveco Daily III (11/97-10/09) Iveco Daily V (09/11-02/14)</p>		<p>Iveco Daily IV (05/06-03/12)</p>	
Suspension Kit		29-16 610 0001	MCR0071
<p><b>Notes</b></p> <p>Front Axle Left Front Axle Right for control arm with ball joint with rubber mount</p> <p>Required quantity replacement in pairs recommended</p>			
<p><b>References</b></p> <p>Chevrolet 96535081 Chevrolet 96535082 Chevrolet 96815893 Chevrolet 96815894 Chevrolet 96870465 Daewoo 96535081 Daewoo 96815893</p>		<p>Chevrolet 96535081D Chevrolet 96535082D Chevrolet 96815893D Chevrolet 96815894D Chevrolet 96870466 Daewoo 96535082 Daewoo 96815894</p>	
<p><b>Application info</b></p> <p>Chevrolet Astro I (02/03-05/08) Daewoo Kalos (09/02--)</p>		<p>Chevrolet Aveo I (01/03--)</p>	

## Suspension Kit

314 610 0034/HD

MCR0040HD

## Notes

Carbon Neutral  
Front Axle Left  
Front Axle Right  
without holder

Height [mm] 80  
Inner Diameter [mm] 25  
Outer Diameter [mm] 70  
Replace in pairs only  
Required quantity 2  
reinforced version



## References

BMW 31 12 6 850 403	BMW 31 12 6 850 404
BMW 31 12 6 874 341	BMW 31 12 6 874 342
BMW 31 12 6 882 843	BMW 31 12 6 882 844
BMW 31 12 8 831 645	BMW 31 12 8 831 646
BMW 6 850 403	BMW 6 850 404
BMW 6 874 341	BMW 6 874 342
BMW 6 882 843	BMW 6 882 844
BMW 8 831 645	BMW 8 831 646
Mini 31 12 6 850 403	Mini 31 12 6 850 404
Mini 31 12 6 874 341	Mini 31 12 6 874 342
Mini 31 12 6 882 843	Mini 31 12 6 882 844
Mini 31 12 8 831 645	Mini 31 12 8 831 646
Mini 6 850 403	Mini 6 850 404
Mini 6 874 341	Mini 6 874 342
Mini 6 882 843	Mini 6 882 844
Mini 8 831 645	Mini 8 831 646

## Application info

BMW 1 (F40), 2 Gran Coupe (F44) (07/19--)	BMW 2 (F45, F46) (11/13--)
BMW X1 (F48) (11/14--)	BMW X2 (F39) (11/17--)
Mini Countryman II (10/16--)	Mini Mini III (09/13--)

## Suspension Kit

314 610 0035/HD

MCR0039HD

## Notes

Carbon Neutral  
Front Axle Left  
Front Axle Right  
with holder

Replace in pairs only  
Required quantity  
reinforced version

2



## References

BMW 31 12 6 850 403  
BMW 31 12 6 874 341  
BMW 31 12 6 882 843  
BMW 31 12 8 831 645  
BMW 6 850 403  
BMW 6 874 341  
BMW 6 882 843  
BMW 8 831 645  
Mini 31 12 6 850 403  
Mini 31 12 6 874 341  
Mini 31 12 6 882 843  
Mini 31 12 8 831 645  
Mini 6 850 403  
Mini 6 874 341  
Mini 6 882 843  
Mini 8 831 645

BMW 31 12 6 850 404  
BMW 31 12 6 874 342  
BMW 31 12 6 882 844  
BMW 31 12 8 831 646  
BMW 6 850 404  
BMW 6 874 342  
BMW 6 882 844  
BMW 8 831 646  
Mini 31 12 6 850 404  
Mini 31 12 6 874 342  
Mini 31 12 6 882 844  
Mini 31 12 8 831 646  
Mini 6 850 404  
Mini 6 874 342  
Mini 6 882 844  
Mini 8 831 646

## Application info

BMW 1 (F40), 2 Gran Coupe (F44) (07/19--)  
BMW X1 (F48) (11/14--)  
Mini Countryman II (10/16--)

BMW 2 (F45, F46) (11/13--)  
BMW X2 (F39) (11/17--)  
Mini Mini III (09/13--)



**Suspension Kit**

314 610 0037

MCR0047

**Notes**

Required quantity  
replacement in pairs recommended

Front Axle Left  
Front Axle Right  
2



**References**

- |                                  |                                  |
|----------------------------------|----------------------------------|
| BMW 31 12 6 775 963              | BMW 31 12 6 775 964              |
| BMW 31 12 6 775 967              | BMW 31 12 6 775 971              |
| BMW 31 12 6 775 972              | BMW 31 12 6 775 979              |
| BMW 31 12 6 775 980              | BMW 31 12 6 775 981              |
| BMW 31 12 6 779 871              | BMW 31 12 6 779 908              |
| BMW 31 12 6 791 455              | BMW 31 12 6 794 203              |
| BMW 31 12 6 794 204              | BMW 31 12 6 798 107              |
| BMW 31 12 6 798 108              | BMW 31 12 6 850 781              |
| BMW 31 12 6 850 782              | BMW 6 775 963                    |
| BMW 6 775 964                    | BMW 6 775 967                    |
| BMW 6 775 971                    | BMW 6 775 972                    |
| BMW 6 775 979                    | BMW 6 775 980                    |
| BMW 6 775 981                    | BMW 6 779 871                    |
| BMW 6 779 908                    | BMW 6 791 455                    |
| BMW 6 794 203                    | BMW 6 794 204                    |
| BMW 6 798 107                    | BMW 6 798 108                    |
| BMW 6 850 781                    | BMW 6 850 782                    |
| BMW (Brilliance) 31 12 6 775 967 | BMW (Brilliance) 31 12 6 775 971 |
| BMW (Brilliance) 31 12 6 775 972 | BMW (Brilliance) 31 12 6 794 203 |
| BMW (Brilliance) 6 775 967       | BMW (Brilliance) 6 775 971       |
| BMW (Brilliance) 6 775 972       | BMW (Brilliance) 6 794 203       |

**Application info**

- |                                |                                |
|--------------------------------|--------------------------------|
| BMW 5 (F10, F11) (01/09-02/17) | BMW 6 (F12, F13) (12/10-10/18) |
|--------------------------------|--------------------------------|

Suspension Kit		314 610 0038	MCR0058												
<p><b>Notes</b></p> <p>Required quantity replacement in pairs recommended</p>		<p>Front Axle Left Front Axle Right 2</p>													
<p><b>References</b></p> <table border="0"> <tr> <td>BMW 31 10 6 771 194</td> <td>BMW 31 10 6 771 897</td> </tr> <tr> <td>BMW 31 10 6 778 015</td> <td>BMW 31 12 6 851 693</td> </tr> <tr> <td>BMW 31 12 6 855 509</td> <td>BMW 31 12 6 863 171</td> </tr> <tr> <td>BMW 6 771 194</td> <td>BMW 6 771 897</td> </tr> <tr> <td>BMW 6 778 015</td> <td>BMW 6 851 693</td> </tr> <tr> <td>BMW 6 855 509</td> <td>BMW 6 863 171</td> </tr> </table>				BMW 31 10 6 771 194	BMW 31 10 6 771 897	BMW 31 10 6 778 015	BMW 31 12 6 851 693	BMW 31 12 6 855 509	BMW 31 12 6 863 171	BMW 6 771 194	BMW 6 771 897	BMW 6 778 015	BMW 6 851 693	BMW 6 855 509	BMW 6 863 171
BMW 31 10 6 771 194	BMW 31 10 6 771 897														
BMW 31 10 6 778 015	BMW 31 12 6 851 693														
BMW 31 12 6 855 509	BMW 31 12 6 863 171														
BMW 6 771 194	BMW 6 771 897														
BMW 6 778 015	BMW 6 851 693														
BMW 6 855 509	BMW 6 863 171														
<p><b>Application info</b></p> <table border="0"> <tr> <td>BMW X5 (E70) (02/06-07/13)</td> <td>BMW X6 (E71) (06/07-07/14)</td> </tr> </table>				BMW X5 (E70) (02/06-07/13)	BMW X6 (E71) (06/07-07/14)										
BMW X5 (E70) (02/06-07/13)	BMW X6 (E71) (06/07-07/14)														



DRIVER'S BEST FRIEND

MEYLE

Steering

Axial rod

316 030 0000

MAR0201

Notes

Front Axle Left  
Front Axle Right

Length [mm] 174  
Required quantity 2  
Thread Size 1 M18x1,5  
Thread Size 2 M16x1,0  
replacement in pairs recommended



References

- |                     |                     |
|---------------------|---------------------|
| BMW 1 091 767       | BMW 1 091 768       |
| BMW 1 091 769       | BMW 1 093 769       |
| BMW 1 093 770       | BMW 1 094 673       |
| BMW 1 094 674       | BMW 32 11 1 091 767 |
| BMW 32 11 1 091 768 | BMW 32 11 1 091 769 |
| BMW 32 11 1 093 769 | BMW 32 11 1 093 770 |
| BMW 32 11 1 094 673 | BMW 32 11 1 094 674 |

Application info

BMW 5 (E39) (09/95-06/04)

Axial rod

316 030 3042

MAR0202

Notes

Front Axle Left  
Front Axle Right

Length [mm] 228  
Required quantity 2  
Thread Size 1 M18x1,5  
Thread Size 2 M16x1,5  
replacement in pairs recommended



References

- |                     |                     |
|---------------------|---------------------|
| BMW 32 10 6 774 360 | BMW 32 10 6 777 268 |
| BMW 32 21 6 756 368 | BMW 6 756 368       |
| BMW 6 774 360       | BMW 6 777 268       |

**Application info**

BMW 7 (E65, E66) (07/01-12/09)

**Axial rod**

316 030 3044

MAR0203

**Notes**Front Axle Left  
Front Axle Right

Length [mm]

219

Required quantity

2

Thread Size 1

M18x1,5

Thread Size 2

M14x1,5

replacement in pairs recommended

**References**

BMW 3 412 798

BMW 3 418 204

BMW 3 444 999

BMW 32 10 3 412 798

BMW 32 10 3 444 999

BMW 32 10 6 780 985

BMW 32 10 6 793 496

BMW 32 21 6 751 277

BMW 32 21 6 773 740

BMW 32 21 6 773 741

BMW 32 30 3 418 204

BMW 6 751 277

BMW 6 773 740

BMW 6 773 741

BMW 6 780 985

BMW 6 793 496

**Application info**

BMW X3 (E83) (01/03-12/11)

BMW X5 (E53) (01/00-12/06)

BMW X5 (E70) (02/06-07/13)

BMW X6 (E71) (06/07-07/14)

**Axial rod**

316 030 4342

MAR0206

**Notes**Front Axle Left  
Front Axle Right

Length [mm]

205

Required quantity

2

Thread Size 1

M18x1,5

Thread Size 2

M14x1,5

replacement in pairs recommended

**References**

BMW 1 139 315

BMW 1 139 316

BMW 32 11 1 139 315

BMW 32 11 1 139 316

**Application info**

BMW 3 (E36) (09/90-08/00)

BMW Z3 (E36/7, E36/8) (10/95-06/03)

**Axial rod**

316 030 4600

MAR0207

**Notes**

Front Axle Left  
Front Axle Right

Length [mm] 207  
Required quantity 2  
Thread Size 1 M18x1,5  
Thread Size 2 M14x1,5  
replacement in pairs recommended



**References**

- |                                  |                                  |
|----------------------------------|----------------------------------|
| BMW 1 096 897                    | BMW 1 096 898                    |
| BMW 32 10 6 774 222              | BMW 32 10 6 774 223              |
| BMW 32 10 6 777 503              | BMW 32 10 6 777 504              |
| BMW 32 11 1 096 897              | BMW 32 21 1 096 898              |
| BMW 6 774 222                    | BMW 6 774 223                    |
| BMW 6 777 503                    | BMW 6 777 504                    |
| BMW (Brilliance) 1 096 897       | BMW (Brilliance) 1 096 898       |
| BMW (Brilliance) 32 10 6 774 222 | BMW (Brilliance) 32 10 6 774 223 |
| BMW (Brilliance) 32 10 6 777 503 | BMW (Brilliance) 32 10 6 777 504 |
| BMW (Brilliance) 32 11 1 096 897 | BMW (Brilliance) 32 21 1 096 898 |
| BMW (Brilliance) 6 774 222       | BMW (Brilliance) 6 774 223       |
| BMW (Brilliance) 6 777 503       | BMW (Brilliance) 6 777 504       |

**Application info**

BMW 3 (E46) (12/97-12/07)

BMW Z4 (E85) (09/02-12/09)

BMW Z4 (E86) (03/06-01/09)

**Axial rod**

316 031 0000

MAR0208

**Notes**

Front Axle Left  
Front Axle Right

Length [mm] 184  
Required quantity 2  
Thread Size 1 M16x1,5  
Thread Size 2 M14x1,5  
replacement in pairs recommended



**References**

Mini 32 11 6 754 563

Mini 32 11 6 780 785

Mini 6 754 563

Mini 6 780 785

Mini 32 11 6 754 564

Mini 32 11 6 780 786

Mini 6 754 564

Mini 6 780 786

**Application info**

Mini Mini I (06/01-07/08)

**Axial rod**

316 031 0003

MAR0209

**Notes**Front Axle Left  
Front Axle Right

Length [mm]

239

Required quantity

2

Thread Size 1

M18x1,5

Thread Size 2

M16x1,5

replacement in pairs recommended

**References**

BMW 32 10 6 774 347

BMW 32 21 6 762 403

BMW 32 21 6 777 451

BMW 6 767 861

BMW 6 777 451

BMW (Brilliance) 32 10 6 774 347

BMW (Brilliance) 32 21 6 762 403

BMW (Brilliance) 32 21 6 777 451

BMW (Brilliance) 6 767 861

BMW (Brilliance) 6 777 451

BMW 32 10 6 777 479

BMW 32 21 6 767 861

BMW 6 762 403

BMW 6 774 347

BMW 6 777 479

BMW (Brilliance) 32 10 6 777 479

BMW (Brilliance) 32 21 6 767 861

BMW (Brilliance) 6 762 403





BMW (Brilliance) 6 774 347

BMW (Brilliance) 6 777 479

**Application info**

BMW 5 (E60, E61) (12/01-12/10)

BMW 6 (E63, E64) (09/03-12/10)

Axial rod		316 031 0004	MAR0210
<b>Notes</b>  Front Axle Left Front Axle Right  Length [mm] 246 Manufacturer Restriction TRW Required quantity 2 Thread Size 1 M18x1,5 Thread Size 2 M14x1,5 replacement in pairs recommended		 	
<b>References</b> BMW 32 21 6 762 243 BMW 32 21 6 762 244 BMW 6 762 243 BMW 6 762 244 BMW (Brilliance) 32 21 6 762 243 BMW (Brilliance) 32 21 6 762 244 BMW (Brilliance) 6 762 243 BMW (Brilliance) 6 762 244			
<b>Application info</b> BMW 1 (E81, E82, E87, E88) (02/03-12/13) BMW 3 (E90, E91, E92, E93) (02/04-12/13) BMW X1 (E84) (03/09-06/15)			
Axial rod		316 031 0005	MAR0211
<b>Notes</b>  Front Axle Left Front Axle Right for vehicles with power steering  Length [mm] 256 Manufacturer Restriction ZF Required quantity 2 Thread Size 1 M18x1,5 Thread Size 2 M14x1,5 replacement in pairs recommended		 	
<b>References</b> BMW 32 10 6 765 235 BMW 32 10 6 765 236 BMW 6 765 235 BMW 6 765 236 BMW (Brilliance) 32 10 6 765 235 BMW (Brilliance) 32 10 6 765 236 BMW (Brilliance) 6 765 235 BMW (Brilliance) 6 765 236			

**Application info**

BMW 1 (E81, E82, E87, E88) (02/03-12/13)  
 BMW 3 (F30, F31) (11/11-06/19)  
 BMW Z4 (E89) (02/09-08/16)

BMW 3 (E90, E91, E92, E93) (02/04-12/13)  
 BMW X1 (E84) (03/09-06/15)

**Axial rod**

316 031 0006

MAR0212

**Notes**

Front Axle Left  
 Front Axle Right  
 Length [mm] 196  
 Required quantity 2  
 Thread Size 1 M14x1,5  
 Thread Size 2 M14x1,5  
 replacement in pairs recommended



**References**

Mini 32 10 6 778 547	Mini 32 10 6 778 548
Mini 32 10 9 803 321	Mini 32 10 9 803 322
Mini 32 10 9 808 837	Mini 32 10 9 808 838
Mini 6 778 547	Mini 6 778 548
Mini 9 803 321	Mini 9 803 322
Mini 9 808 837	Mini 9 808 838

**Application info**

Mini Countryman I (08/10-10/16)  
 Mini Paceman (03/12-10/16)

Mini Mini II (11/05-12/15)

**Axial rod**

316 031 0008

MAR0213

**Notes**

Front Axle Left  
 Front Axle Right  
 Length [mm] 260  
 Required quantity 2  
 Thread Size 1 M18x1,5  
 Thread Size 2 M14x1,5  
 replacement in pairs recommended





**References**

- |                                  |                                  |
|----------------------------------|----------------------------------|
| BMW 32 10 6 768 879              | BMW 32 10 6 768 880              |
| BMW 32 10 6 793 621              | BMW 32 10 6 793 622              |
| BMW 6 768 879                    | BMW 6 768 880                    |
| BMW 6 793 621                    | BMW 6 793 622                    |
| BMW (Brilliance) 32 10 6 768 879 | BMW (Brilliance) 32 10 6 768 880 |
| BMW (Brilliance) 6 768 879       | BMW (Brilliance) 6 768 880       |

**Application info**

- |  |                            |
|--|----------------------------|
| BMW 3 (E90, E91, E92, E93) (02/04-12/13) | BMW X1 (E84) (03/09-06/15) |
|--|----------------------------|

**Axial rod**

**316 031 0010    MAR0214**

**Notes**

- Front Axle Left
- Front Axle Right

- Length [mm] 198
- Required quantity 2
- Thread Size 1 M18x1,5
- Thread Size 2 M14x1,5
- replacement in pairs recommended



**References**

- |                     |                     |
|---------------------|---------------------|
| BMW 32 10 6 774 318 | BMW 32 10 6 774 319 |
| BMW 6 774 318       | BMW 6 774 319       |

**Application info**

- BMW 3 (E46) (12/97-12/07)

**Axial rod**

**316 031 0011    MAR0215**

**Notes**

- Front Axle Left
- Front Axle Right

- Length [mm] 245
- Required quantity 2
- Thread Size 1 M18x1,5
- Thread Size 2 M14x1,5
- replacement in pairs recommended



**References**

BMW 32 10 6 784 716

BMW 32 10 6 784 792

BMW 6 784 719

BMW (Brilliance) 32 10 6 784 716

BMW (Brilliance) 6 784 716

BMW 32 10 6 784 719

BMW 6 784 716

BMW 6 784 792

BMW (Brilliance) 32 10 6 784 719

BMW (Brilliance) 6 784 719

**Application info**

BMW 5 (F07) (01/09-02/17)

BMW 6 (F12, F13) (12/10-10/18)

BMW 5 (F10, F11) (01/09-02/17)

BMW 7 (F01, F02, F03, F04) (02/08-12/15)

**Axial rod****316 031 0012****MAR0216****Notes**Front Axle Left  
Front Axle Right

Length [mm]

253

Required quantity

2

Thread Size 1

M16x1,5

Thread Size 2

M14x1,5

replacement in pairs recommended

**References**

BMW 32 10 6 799 960

BMW 6 799 960

BMW (Brilliance) 32 10 6 799 960

BMW (Brilliance) 6 799 960

BMW 32 10 6 799 965

BMW 6 799 965

BMW (Brilliance) 32 10 6 799 965

BMW (Brilliance) 6 799 965

**Application info**



BMW 1 (F20, F21) (07/11--)

BMW 3 (F30, F31) (11/11-06/19)

BMW 4 (F32, F33, F36) (07/13--)

BMW 2 (F22,F23) (10/12--)

BMW 3 (F34) (07/12--)

Axial rod		316 031 0013	MAR0217
<b>Notes</b>  Front Axle Left Front Axle Right  Length [mm] 247 Required quantity 2 Thread Size 1 M16x1,5 Thread Size 2 M14x1,5 replacement in pairs recommended			
<b>References</b> BMW 32 10 6 792 029 BMW 6 792 029 BMW (Brilliance) 32 10 6 792 029 BMW (Brilliance) 6 792 029		BMW 32 10 6 792 030 BMW 6 792 030 BMW (Brilliance) 32 10 6 792 030 BMW (Brilliance) 6 792 030	
<b>Application info</b> BMW 1 (F20, F21) (07/11--) BMW 3 (F30, F31) (11/11-06/19) BMW 4 (F32, F33, F36) (07/13--) BMW 2 (F22,F23) (10/12--) BMW 3 (F34) (07/12--) BMW X3 (F25) (09/10-08/17) BMW X4 (F26) (05/13-03/18)			
Axial rod		316 031 0014	MAR0390
<b>Notes</b>  Front Axle Left Front Axle Right  Length [mm] 229 Required quantity 2 Thread Size 1 M16X1.5 Thread Size 2 M16x1.5 replacement in pairs recommended			
<b>References</b> BMW 32 10 6 787 472		BMW 6 787 472	
<b>Application info</b> BMW X3 (F25) (09/10-08/17) BMW X4 (F26) (05/13-03/18)			

## Axial rod

316 031 0017/HD

MAR0518HD

## Notes

Carbon Neutral  
Front Axle Left  
Front Axle Right

Length [mm] 239  
Required quantity 2  
Thread Size 1 M18x1,5  
Thread Size 2 M16x1,5  
reinforced version  
replacement in pairs recommended



## References

BMW 32 10 6 774 347

BMW 32 21 6 762 403

BMW 32 21 6 777 451

BMW 6 767 861

BMW 6 777 451

BMW (Brilliance) 32 10 6 774 347

BMW (Brilliance) 32 21 6 762 403

BMW (Brilliance) 32 21 6 777 451

BMW (Brilliance) 6 767 861

BMW (Brilliance) 6 777 451

BMW 32 10 6 777 479

BMW 32 21 6 767 861

BMW 6 762 403

BMW 6 774 347

BMW 6 777 479

BMW (Brilliance) 32 10 6 777 479

BMW (Brilliance) 32 21 6 767 861

BMW (Brilliance) 6 762 403

BMW (Brilliance) 6 774 347

BMW (Brilliance) 6 777 479

## Application info

BMW 5 (E60, E61) (12/01-12/10)

BMW 6 (E63, E64) (09/03-12/10)

## Axial rod

316 031 0018/HD

MAR0519HD

## Notes

Carbon Neutral  
Front Axle Left  
Front Axle Right

Length [mm] 246  
Manufacturer Restriction TRW  
Required quantity 2  
Thread Size 1 M18x1,5  
Thread Size 2 M14x1,5  
reinforced version  
replacement in pairs recommended



**References**

BMW 32 21 6 762 243

BMW 6 762 243

BMW (Brilliance) 32 21 6 762 243

BMW (Brilliance) 6 762 243

BMW 32 21 6 762 244

BMW 6 762 244

BMW (Brilliance) 32 21 6 762 244

BMW (Brilliance) 6 762 244

**Application info**

BMW 1 (E81, E82, E87, E88) (02/03-12/13)

BMW X1 (E84) (03/09-06/15)

BMW 3 (E90, E91, E92, E93) (02/04-12/13)

**Axial rod****316 031 0019/HD****MAR0545HD****Notes**Carbon Neutral  
Front Axle Left  
Front Axle Right

Length [mm]

221

Required quantity

2

Thread Size 1

M14x1,5

Thread Size 2

M14X1,5

reinforced version

replacement in pairs recommended

**References**

BMW 32 10 6 867 404

BMW 32 10 6 899 815

BMW 6 867 404

BMW 6 899 815

BMW (Brilliance) 32 10 6 867 404

BMW (Brilliance) 6 867 404

Mini 32 10 6 867 404

Mini 32 10 6 899 815

Mini 6 867 404

Mini 6 899 815

BMW 32 10 6 867 405

BMW 32 10 6 899 816

BMW 6 867 405

BMW 6 899 816

BMW (Brilliance) 32 10 6 867 405

BMW (Brilliance) 6 867 405

Mini 32 10 6 867 405

Mini 32 10 6 899 816

Mini 6 867 405

Mini 6 899 816

**Application info**

BMW 1 (F40), 2 Gran Coupe (F44) (07/19--)

BMW 2 (F45, F46) (11/13--)

BMW X2 (F39) (11/17--)

Mini Mini III (09/13--)

BMW 1 (F52) (01/17--)

BMW X1 (F48) (11/14--)

Mini Countryman II (10/16--)

## Axial rod

316 031 0020/HD

MAR0546HD

## Notes

Carbon Neutral  
Front Axle Left  
Front Axle Right

Length [mm]

190

Required quantity

2

Thread Size 1

M14x1,5

Thread Size 2

M14X1,5

reinforced version

replacement in pairs recommended



## References

Mini 32 10 6 854 733

Mini 32 10 6 854 736

Mini 32 10 6 899 813

Mini 32 10 6 899 814

Mini 6 854 733

Mini 6 854 736

Mini 6 899 813

Mini 6 899 814

## Application info

Mini Mini III (09/13--)

## Axial rod

316 031 0021

MAR0548

## Notes

Front Axle Left  
Front Axle Right  
for vehicles without active steering

Length [mm]

224

Required quantity

2

Thread Size 1

16x1,5

Thread Size 2

14x1,5

replacement in pairs recommended



## References

BMW 32 10 6 858 735

BMW 32 10 6 858 737

BMW 6 858 735

BMW 6 858 737

## Application info

BMW X5 (F15) (08/13-07/18)

BMW X6 (F16) (08/14-07/19)

**Axial rod** **316 031 0022** **MAR0549**

**Notes**

Front Axle Left  
 Front Axle Right  
 for vehicles with active steering

Length [mm] 223  
 Required quantity 2  
 Thread Size 1 18x1,5  
 Thread Size 2 14x1,5  
 replacement in pairs recommended



**References**

BMW 32 10 6 863 857 BMW 32 10 6 863 859  
 BMW 6 863 857 BMW 6 863 859

**Application info**

BMW X5 (F15) (08/13-07/18) BMW X6 (F16) (08/14-07/19)

**Axial rod** **316 031 0023/HD** **MAR0575HD**

**Notes**

Carbon Neutral  
 Front Axle Left  
 Front Axle Right

Length [mm] 208  
 Required quantity 2  
 Thread Size 1 M16x1,5  
 Thread Size 2 M14x1,5  
 reinforced version  
 replacement in pairs recommended



**References**

BMW 32 10 6 868 688 BMW 32 10 6 868 689  
 BMW 32 10 6 869 535 BMW 32 10 6 869 537  
 BMW 32 10 6 881 536 BMW 32 10 6 881 537  
 BMW 32 10 6 885 165 BMW 32 10 6 885 166  
 BMW 6 868 688 BMW 6 868 689  
 BMW 6 869 535 BMW 6 869 537  
 BMW 6 881 536 BMW 6 881 537  
 BMW 6 885 165 BMW 6 885 166

**Application info**

BMW 5 (G30, G31) (09/16--)

BMW 7 (G11, G12) (07/15--)

BMW 8 Gran Coupe (G16) (07/19--)

BMW 6 (G32) (06/17--)

BMW 8 (G15) (07/18--)

**Axial rod**

316 031 0024

MAR0601

**Notes**

Front Axle Left  
Front Axle Right

Length [mm]

327

Required quantity

2

Thread Size 1

M14x1,5

Thread Size 2

M14x1,5

replacement in pairs recommended



**References**

BMW 32 21 6 851 409

BMW 6 851 409

BMW 32 21 6 851 410

BMW 6 851 410

**Application info**

BMW i3 (08/13--)

**Axial rod**

316 031 0025

MAR0636

**Notes**

Front Axle Left  
Front Axle Right

Length [mm]

251

Required quantity

2

Thread Size 1

M16x1,5

Thread Size 2

M14x1,5

replacement in pairs recommended



**References**

BMW 32 10 6 871 884

BMW 32 10 6 880 695

BMW 6 871 884

BMW 6 880 695

BMW 32 10 6 871 892

BMW 32 10 6 880 697

BMW 6 871 892

BMW 6 880 697



**Application info**

BMW 2 (G42) (08/21--)  
 BMW 4 (G22, G23, G26) (07/20--)  
 BMW X4 (G02) (04/18--)

BMW 3 (G20, G21) (11/18--)  
 BMW X3 (G01) (07/17--)  
 BMW i4 (G26) (11/21--)

**Axial rod**

316 031 0026/HD

MAR0639HD

**Notes**

Carbon Neutral  
 Front Axle Left  
 Front Axle Right

Length [mm]  
 Required quantity  
 Thread Size 1  
 Thread Size 2  
 reinforced version  
 replacement in pairs recommended

250  
 2  
 M16x1,5  
 M16x1,5



**References**

BMW 32 10 6 884 809  
 BMW 6 884 809

BMW 32 10 6 884 810  
 BMW 6 884 810

**Application info**

BMW X5 (G05) (08/18--)  
 BMW X7 (G07) (03/19--)

BMW X6 (G06) (08/19--)

**Axial rod**

316 031 0027

MAR0643

**Notes**

Front Axle Left  
 Front Axle Right

Length [mm]  
 Required quantity  
 Thread Size 1  
 Thread Size 2  
 replacement in pairs recommended

255  
 2  
 M16x1,5  
 M16x1,5



**References**

BMW 1 543 909

BMW 32 10 1 543 909

BMW 32 10 6 886 678

BMW 6 886 678

Toyota 45460-WAA02

Toyota 45470-WAA02

BMW 1 543 910

BMW 32 10 1 543 910

BMW 32 10 6 886 679

BMW 6 886 679

Toyota 45460-WAA03

Toyota 45470-WAA03

**Application info**

BMW Z4 Roadster (G29) (11/18--)

Toyota Supra V (\_A9\_) (03/19--)

**Axial rod****32-16 030 0007****MAR0219****Notes**Front Axle Left  
Front Axle Right

Length [mm]

322

Required quantity

2

Thread Size 1

M16x1,5

Thread Size 2

M14x1,5

replacement in pairs recommended

**References**

Mitsubishi 4422A057

Mitsubishi MR403100

Mitsubishi 4422A079

**Application info**

Mitsubishi Outlander I (03/01-07/08)

Mitsubishi Space Runner II / Wagon III (07/98-12/04)

**Axial rod****32-16 031 0019/HD****MAR0223HD****Notes**Carbon Neutral  
Front Axle Left  
Front Axle Right

Length [mm]

198

Required quantity

2

Thread Size 1

M16x1,5

Thread Size 2

M16x1,5

reinforced version

replacement in pairs recommended



**References**

Fiat 6000609635

Mitsubishi 4410A173

Mitsubishi 4410A173T

**Application info**

Fiat Fullback Pick Up (01/16--)

Mitsubishi L200 IV (01/04-12/16)

Mitsubishi L200 V (11/14--)

Mitsubishi Pajero Sport II (KH0) (01/08--)

Mitsubishi Pajero Sport III (KS) (08/15--)

**Axial rod****33-16 030 0005****MAR0226****Notes**

Front Axle Left

Length [mm]

334

Paired article number

33-16 030 0006 | MAR0227

Required quantity

1

Thread Size 1

M16x1

Thread Size 2

M14x1,5

replacement in pairs recommended

**References**

Fiat 71750067

Suzuki 48830-79J10

Suzuki 48830-79J10-000

**Application info**

Fiat Sedici (06/06-10/14)

Suzuki SX4 (06/06--)

**Axial rod****33-16 030 0006****MAR0227****Notes**

Front Axle Right

Length [mm]

334

Paired article number

33-16 030 0005 | MAR0226

Required quantity

1

Thread Size 1

M16x1

Thread Size 2

M14x1,5

replacement in pairs recommended

**References**

Suzuki 48830-79J00

Suzuki 48830-79J00-000

**Application info**

Fiat Sedici (06/06-10/14)

Suzuki SX4 (06/06--)

**Axial rod**

33-16 031 0011/HD

MAR0640HD

**Notes**

Carbon Neutral  
 Front Axle Left  
 Front Axle Right

Length [mm] 294  
 Required quantity 2  
 Thread Size 1 M16X1,0  
 Thread Size 2 M14X1,5  
 reinforced version  
 replacement in pairs recommended

**References**

Suzuki 48830-62R00

**Application info**

Suzuki Ignis III (MF) (10/16--)

**Axial rod**

33-16 031 0012/HD

MAR0635HD

**Notes**

Carbon Neutral  
 Front Axle Left  
 Front Axle Right



Length [mm] 321.5  
 Required quantity 2  
 Thread Size 1 M18X1,5  
 Thread Size 2 M14X1,5  
 reinforced version  
 replacement in pairs recommended

**References**

Suzuki 48830-52R00

**Application info**

Suzuki Swift V (01/17--)

Axial rod		33-16 031 0013/HD	MAR0609HD
<b>Notes</b>  Carbon Neutral Front Axle Left Front Axle Right  Length [mm] 324 Required quantity 2 Thread Size 1 14x1,5 Thread Size 2 14x1,5 reinforced version replacement in pairs recommended			
<b>References</b> Suzuki 48830M68P00		Suzuki 48830M68P00-000	
<b>Application info</b> Suzuki Baleno II (02/16--)			
Axial rod		33-16 031 0014	MAR0583
<b>Notes</b>  Front Axle Left Front Axle Right  Length [mm] 320 Required quantity 2 Thread Size 1 M18x1,5 Thread Size 2 M14x1,5 replacement in pairs recommended			
<b>References</b> Suzuki 48830-61M00			
<b>Application info</b> Suzuki SX4 S-Cross (08/13--)			
		Suzuki Vitara II (LY) (02/15--)	

## Axial rod

34-16 031 0009/HD

MAR0627HD

## Notes

Carbon Neutral

Length [mm]

325

Required quantity

2

Thread Size 1

M16X1,5

Thread Size 2

M14X1,5

replacement in pairs recommended



## References

Subaru 34160XA010

## Application info

Subaru Forester III (SH) (12/07--)

Subaru Impreza III (GR) (01/07--)

Subaru Levorg (03/15--)

Subaru Tribeca (B9) (01/05--)

Subaru XV I (09/11--)

Subaru Forester IV (SJ) (11/12--)

Subaru Legacy VI (BN, BS) (01/15--)

Subaru Outback V (10/14--)

Subaru WRX (GP,GJ) (07/11-12/12)

## Axial rod

34-16 031 0010/HD

MAR0623HD

## Notes

Carbon Neutral

Front Axle Left

Front Axle Right

Length [mm]

325

Required quantity

2

Thread Size 1

M16X1,5

Thread Size 2

M14X1,5

reinforced version

replacement in pairs recommended



## References

Subaru 34160SC020

## Application info

Subaru Forester III (SH) (12/07--)

Subaru Forester V (SK) (04/18--)

Subaru XV I (09/11--)

Subaru Forester IV (SJ) (11/12--)

Subaru Impreza V (GT) (10/16--)

Subaru XV II (04/17--)

**Axial rod****34-16 031 0011/HD****MAR0616HD****Notes**

Carbon Neutral  
 Front Axle Left  
 Front Axle Right

Length [mm]

226

Required quantity

2

Thread Size 1

M16X1,5

Thread Size 2

M14X1,5

reinforced version

replacement in pairs recommended

**References**

Subaru 34160CA000

Toyota SU003-00832

**Application info**

Subaru BRZ (06/12--)

Toyota GT 86 Coupe (03/12--)

**Axial rod****35-16 031 0008****MAR0243****Notes**

Front Axle Left  
 Front Axle Right

Length [mm]

307

Required quantity

2

Thread Size 1

M18x1,5

Thread Size 2

M14x1,5

replacement in pairs recommended

**References**

Mazda GE4T-32-240

Mazda GE4T-32-240A

**Application info**

Mazda 626 (GF, GW) (05/97-12/02)

**Axial rod**

35-16 031 0014/HD

MAR0473HD

**Notes**

Carbon Neutral  
Front Axle Left  
Front Axle Right

Length [mm]

304

Required quantity

2

Thread Size 1

M14X1,5

Thread Size 2

M14x1,5

reinforced version

replacement in pairs recommended



**References**

Mazda KD31-32-240

Mazda KD31-32-240A

**Application info**

Mazda CX-5 I (KE) (11/11-02/17)

**Axial rod**

35-16 031 0029/HD

MAR0520HD

**Notes**

Carbon Neutral  
Front Axle Left  
Front Axle Right

Length [mm]

234.5

Required quantity

2

Thread Size 1

16x1

Thread Size 2

14x1,5

reinforced version

replacement in pairs recommended



**References**

Mazda NE51-32 240

**Application info**

Mazda MX-5 (NC) (03/05-12/14)





**Axial rod** **35-16 031 0032** **MAR0596**

**Notes**

Front Axle Left  
Front Axle Right

Length [mm] 254  
Required quantity 2  
Thread Size 1 14x1,5  
Thread Size 2 14x1,5  
replacement in pairs recommended



**References**

Mazda K123-32-240

**Application info**

Mazda CX-5 II (KF) (11/16--)

**Axial rod** **35-16 031 0033/HD** **MAR0593HD**

**Notes**

Carbon Neutral  
Front Axle Left  
Front Axle Right

Length [mm] 218  
Required quantity 2  
Thread Size 1 14x1,5  
Thread Size 2 14x1,5  
reinforced version  
replacement in pairs recommended



**References**

Mazda BJS8-32-240  
Mazda GHT2-32-240A

Mazda GHT2-32-240

**Application info**

Mazda 3 (BM) (07/13--)

Mazda 6 (GJ) (08/12--)

**Axial rod**

35-16 031 0034

MAR0657

**Notes**

Front Axle Left  
Front Axle Right

Length [mm] 226  
Required quantity 2  
Thread Size 1 16x1,5  
Thread Size 2 14x1,5  
replacement in pairs recommended

**References**

Mazda D09H-32-240

**Application info**

Mazda 2 (DJ) (08/14--)

**Axial rod**

35-16 031 0035

MAR0658

**Notes**

Front Axle Left  
Front Axle Right

Length [mm] 164  
Required quantity 2  
Thread Size 1 M18X1,5  
Thread Size 2 M14x1,5  
replacement in pairs recommended

**References**

Mazda GS1D-32-240

**Application info**

Mazda 6 (GH) (08/07-12/13)

**Axial rod****36-16 030 0022/HD****MAR0250HD****Notes**

Carbon Neutral  
 Front Axle Left  
 Front Axle Right

Length [mm] 203  
 Required quantity 2  
 Thread Size 1 M20x1  
 Thread Size 2 M16x1,5  
 reinforced version  
 replacement in pairs recommended

**References**

Nissan 48521-EA000

**Application info**

Nissan Navara (D40) (10/04--)

Nissan Pathfinder (R51) (01/05--)

**Axial rod****36-16 031 0005****MAR0254****Notes**

Front Axle Left  
 Front Axle Right

Length [mm] 287  
 Required quantity 2  
 Thread Size 1 M16x1  
 Thread Size 2 M14x1,5  
 replacement in pairs recommended

**References**





Nissan 48521-4M500  
 Nissan 48521-4M528  
 Nissan 48521-4M588  
 Nissan 48521-8H325  
 Nissan 48521-8H385

Nissan 48521-4M527  
 Nissan 48521-4M587  
 Nissan 48521-8H300  
 Nissan 48521-8H328  
 Nissan 48521-8H386

**Application info**

Nissan Almera II (01/00--)

Nissan X-Trail (T30) (01/01-12/13)

Axial rod		36-16 031 0008	MAR0255
<b>Notes</b>  Front Axle Left Front Axle Right  Length [mm] 305 Required quantity 2 Thread Size 1 M16x1 Thread Size 2 M14x1,5 replacement in pairs recommended		 	
<b>References</b> Nissan 48521-4U110 Nissan 48521-4U186		Nissan 48521-4U185	
<b>Application info</b> Nissan Almera Tino (12/98-02/06)			
Axial rod		36-16 031 0009	MAR0256
<b>Notes</b>  Front Axle Left Front Axle Right  Length [mm] 280 Required quantity 2 Thread Size 1 M18x1,5 Thread Size 2 M12x1,25 replacement in pairs recommended		 	
<b>References</b> Nissan 49001-AV610		Nissan 49001-BA210	
<b>Application info</b> Nissan Primera (P12, WP12) (01/02-- )			

## Axial rod

36-16 031 0010

MAR0257

## Notes

Front Axle Left  
Front Axle Right

Length [mm] 233  
Required quantity 2  
Thread Size 1 M22x1,5  
Thread Size 2 M14x1,5  
replacement in pairs recommended



## References

Nissan 48001-JD900  
Nissan D8521-JG00A  
Renault D8521JG00A

Nissan D8521-JD00B  
Renault 485219204R

## Application info

Nissan Qashqai I (J10\_) (12/06-04/14)  
Renault Koleos I (09/08--)

Nissan X-Trail (T31) (03/07-12/18)

## Axial rod

36-16 031 0017

MAR0379

## Notes

Front Axle Left  
Front Axle Right

Length [mm] 217.5  
Required quantity 2  
Thread Size 1 M16x1  
Thread Size 2 M12x1,25  
replacement in pairs recommended



## References

Nissan 48001-1KA0A  
Nissan 48001-1KA0D  
Nissan 48001-3NF0A  
Nissan 48001-3NF3A  
Nissan 48001-3YN0B  
Nissan 48001-5SA3A

Nissan 48001-1KA0B  
Nissan 48001-1KA0E  
Nissan 48001-3NF1A  
Nissan 48001-3YN0A  
Nissan 48001-5SA1A  
Nissan 48521-3SG1A

## Application info

Nissan Juke (F15) (06/10--)  
Nissan Leaf II (ZE1) (08/17--)

Nissan Leaf I (ZE0) (11/10--)  
Nissan Sentra VII (B17) (08/12--)

**Axial rod****36-16 031 0019/HD****MAR0462HD****Notes**Carbon Neutral  
Front Axle Left  
Front Axle Right

Length [mm]

272

Required quantity

2

Thread Size 1

14x1,5

Thread Size 2

12x1,25

reinforced version

replacement in pairs recommended

**References**

Nissan 48510-4A00C

Suzuki 48830-84M00

Suzuki 48830-84M00-000

Suzuki 48830-M68K00

**Application info**

Nissan Pixo (03/09--)

Suzuki Alto VII (01/09--)

Suzuki Celerio (02/14--)

**Axial rod****36-16 031 0020/HD****MAR0521HD****Notes**Carbon Neutral  
Front Axle Left  
Front Axle Right

Length [mm]

233

Required quantity

2

Thread Size 1

M22x1,5

Thread Size 2

M14x1,5

reinforced version

replacement in pairs recommended

**References**

Nissan 48001-JD900

Nissan D8521-JD00B

Nissan D8521-JG00A

Renault 485219204R

Renault D8521JG00A

**Application info**

Nissan Qashqai I (J10\_) (12/06-04/14)

Nissan X-Trail (T31) (03/07-12/18)

Renault Koleos I (09/08--)

## Axial rod

36-16 031 0021/HD

MAR0649HD

## Notes

Carbon Neutral  
Front Axle Left  
Front Axle Right

Length [mm] 224.1  
Required quantity 2  
Thread Size 1 M16X1,5  
Thread Size 2 M14X1,5  
replacement in pairs recommended



## References

Nissan D85214BA0A

Nissan D8E214BA0A

## Application info

Nissan X-Trail (T32) (10/13--)

## Axial rod

36-16 031 0064

MAR0259

## Notes

Front Axle Left  
Front Axle Right

Length [mm] 200  
Required quantity 2  
Thread Size 1 M14x1,5  
Thread Size 2 M12x1,25  
replacement in pairs recommended



## References

Nissan 48001-9U100

Nissan 48521-3U025

## Application info

Nissan Cube (Z12) (09/07--)



Nissan Micra (K13) (05/10--)

Nissan NV200 (02/10--)

Nissan Note I (01/05-08/13)

Nissan Tiida (05/04-12/13)



Axial rod		36-16 031 0068	MAR0356
<b>Notes</b>  Front Axle Left Front Axle Right  Length [mm] 226 Required quantity 2 Thread Size 1 M14x1,5 Thread Size 2 M12x1,25 replacement in pairs recommended			
<b>References</b> Nissan D8521-1HA0A Nissan D8521-1HJ0A			
<b>Application info</b> Nissan Micra (K13) (05/10--)			
Axial rod		36-16 031 0069	MAR0362
<b>Notes</b>  Front Axle Left Front Axle Right  Length [mm] 282 Required quantity 2 Thread Size 1 M16x1 Thread Size 2 M14x1,5 replacement in pairs recommended			
<b>References</b> Nissan 48521-CB025 Nissan 48521-CB026 Nissan 48521-CB027 Nissan D85211AA0A			
<b>Application info</b> Nissan Murano (Z50) (04/02-12/09)			

**Axial rod** **37-16 030 0003** **MAR0262**

<b>Notes</b>	Front Axle Left Front Axle Right	
Length [mm]	167	
Required quantity	2	
Thread Size 1	M16x1,5	
Thread Size 2	M16x1,5	
replacement in pairs recommended		

<b>References</b> Hyundai 57724-2B000
--

<b>Application info</b> Hyundai Santa Fé II (10/05-03/15)
--

**Axial rod** **37-16 031 0001** **MAR0264**

<b>Notes</b>	Front Axle Left Front Axle Right	
Length [mm]	242	
Required quantity	2	
Thread Size 1	M16x1,5	
Thread Size 2	M16x1,5	
replacement in pairs recommended		

<b>References</b> Hyundai 57724-2E000	Kia 57724 2E000
--	-----------------

<b>Application info</b> Hyundai Tucson I (06/04--)	Kia Sportage II (09/04--)
---	---------------------------

**Axial rod**

37-16 031 0006

MAR0268

**Notes**

Front Axle Left  
Front Axle Right

Length [mm] 318

Required quantity 2

Thread Size 1 M16x1,5

Thread Size 2 M14x1,5

replacement in pairs recommended

**References**

Hyundai 57755-1C000

Hyundai 57775-1C000

**Application info**

Hyundai Getz (06/01-01/11)

**Axial rod**

37-16 031 0009

MAR0271

**Notes**

Front Axle Left  
Front Axle Right

Length [mm] 325

Required quantity 2

Thread Size 1 M16x1,5

Thread Size 2 M14x1,5

replacement in pairs recommended

**References**

Hyundai 57724-3A000

Hyundai 57755-17000





Hyundai 57755-17800

**Application info**

Hyundai Highway (03/00-03/04)

Hyundai Matrix (06/01-08/10)

Hyundai Trajet (09/99-07/08)

Axial rod		37-16 031 0014	MAR0274
<b>Notes</b>  Front Axle Left Front Axle Right  Length [mm] 327 Required quantity 2 Thread Size 1 M16x1,5 Thread Size 2 M14x1,5 replacement in pairs recommended		 	
<b>References</b> Hyundai 57716-34000		Hyundai 57785-26200	
<b>Application info</b> Hyundai Santa Fé I (11/00-03/06)		Hyundai Sonata III (07/92-12/98)	
Axial rod		37-16 031 0018	MAR0277
<b>Notes</b>  Front Axle Left Front Axle Right  Length [mm] 223 Required quantity 2 Thread Size 1 M16x1,5 Thread Size 2 M16x1,5 replacement in pairs recommended		 	
<b>References</b> Hyundai 57724-1J000			
<b>Application info</b> Hyundai i20 I (08/08--)			

**Axial rod**

37-16 031 0020/HD

MAR0522HD

**Notes**

Carbon Neutral  
Front Axle Left  
Front Axle Right

Length [mm]

173

Required quantity

2

Thread Size 1

M16x1,5

Thread Size 2

M16x1,5

reinforced version

replacement in pairs recommended

**References**

Hyundai 57724-2S000

Hyundai 57724-2S010

Kia 57724 2S000

Kia 57724 2S010

**Application info**

Hyundai Tucson I (06/04--)

Hyundai ix35 (08/09--)

Kia Sportage III (09/09--)

**Axial rod**

37-16 031 0021/HD

MAR0523HD

**Notes**

Carbon Neutral  
Front Axle Left  
Front Axle Right

Length [mm]

300

Required quantity

2

Thread Size 1

M16x1,5

Thread Size 2

M12x1,25

reinforced version

replacement in pairs recommended



**References**

Hyundai 57724-0X000

Hyundai 57724-0X010

**Application info**

Hyundai i10 I (10/07--)

Axial rod		37-16 031 0023	MAR0577
<b>Notes</b>  Front Axle Left Front Axle Right  Length [mm] 341 Required quantity 2 Thread Size 1 M16x1,5 Thread Size 2 M14x1,5 replacement in pairs recommended			
<b>References</b> Hyundai 56540-C8000			
<b>Application info</b> Hyundai i20 II (11/14--)			
Axial rod		37-16 031 0024/HD	MAR0612HD
<b>Notes</b>  Carbon Neutral Front Axle Left Front Axle Right  Length [mm] 300 Required quantity 2 Thread Size 1 M16X1,5 Thread Size 2 M16X1,5 reinforced version replacement in pairs recommended			
<b>References</b> Hyundai 56540-F2000 Kia 56540 F2000			
<b>Application info</b> Hyundai Elantra VI (09/15--) Hyundai Kona I (06/17--) Kia Ceed IV (03/18--)		Hyundai Ioniq (AE) (03/16--) Hyundai i30 III (11/16--) Kia Niro I (DE) (09/16--)	

## Axial rod

37-16 031 0025/HD

MAR0568HD

## Notes

Carbon Neutral  
Front Axle Left  
Front Axle Right

Length [mm]

226

Required quantity

2

Thread Size 1

M16x1,5

Thread Size 2

M16X1,5

reinforced version

replacement in pairs recommended



## References

Hyundai 56540-D7000

Kia 56540 D7000

## Application info

Hyundai Tucson II (05/15--)

Kia Sportage IV (09/15--)

## Axial rod

37-16 031 0026/HD

MAR0613HD

## Notes

Carbon Neutral  
Front Axle Left  
Front Axle Right

Length [mm]

231

Required quantity

2

Thread Size 1

M16x1,5

Thread Size 2

M16x1,5

reinforced version

replacement in pairs recommended



## References

Hyundai 57724-D3000

Kia 57724 D3000

## Application info

Hyundai Tucson II (05/15--)

Kia Sportage IV (09/15--)

**Axial rod****37-16 031 0027/HD****MAR0578HD****Notes**Carbon Neutral  
Front Axle Left  
Front Axle Right

Length [mm]

238

Required quantity

2

Thread Size 1

M16x1,5

Thread Size 2

M16x1,5

reinforced version

replacement in pairs recommended

**References**

Hyundai 56540-D7100

Kia 56540 D7100

**Application info**

Hyundai Tucson II (05/15--)

Kia Sportage IV (09/15--)

**Axial rod****37-16 031 0028/HD****MAR0651HD****Notes**Carbon Neutral  
Front Axle Left  
Front Axle Right

Length [mm]

242.4

Required quantity

2

Thread Size 1

M16X1,5

Thread Size 2

M16X1,5

reinforced version

replacement in pairs recommended

**References**

Hyundai 57724-D3100

Kia 57724 D3100

**Application info**

Hyundai NEXO (03/18--)

Hyundai Tucson II (05/15--)

Kia Sportage IV (09/15--)



## Axial rod

37-16 031 0029

MAR0579

## Notes

Front Axle Left  
Front Axle Right

Length [mm] 307  
Required quantity 2  
Thread Size 1 M16x1,5  
Thread Size 2 M14x1,5  
replacement in pairs recommended



## References

Hyundai 56540-B4000

## Application info

Hyundai i10 II (08/13--)

Hyundai i10 III (09/19--)

## Axial rod

37-16 031 0030/HD

MAR0585HD

## Notes

Carbon Neutral  
Front Axle Left  
Front Axle Right

Length [mm] 214  
Required quantity 2  
Thread Size 1 M16x1,5  
Thread Size 2 M16x1,5  
reinforced version  
replacement in pairs recommended



## References

Hyundai 56540-A6000





Kia 56540 A6000

## Application info

Hyundai i30 II (06/11--)

Kia Cee'd II (05/12--)

Kia Cee'd III (03/12--)

Axial rod		37-16 031 0031	MAR0608
<b>Notes</b>  Front Axle Left Front Axle Right  Length [mm] 227 Required quantity 2 Thread Size 1 16x1,5 Thread Size 2 16x1,5 replacement in pairs recommended		 	
<b>References</b> Hyundai 56540-3X000			
<b>Application info</b> Hyundai Elantra V (09/10--) Hyundai Veloster I (03/11-12/17)			
Axial rod		37-16 031 0034/HD	MAR0602HD
<b>Notes</b>  Carbon Neutral Front Axle Left Front Axle Right  Length [mm] 193 Required quantity 2 Thread Size 1 M16x1,5 Thread Size 2 M16X1,5 reinforced version replacement in pairs recommended		 	
<b>References</b> Hyundai 57724-2W000 Kia 57724 2W000 Kia 57724 2T500 Kia 57724 3Q000			
<b>Application info</b> Hyundai Santa Fé III (09/12--) Kia Sorento II (06/09--) Kia Optima (01/10--)			

**Drag link****316 040 4226****MDL0071****Notes**

Front Axle middle  
Guide Rod  
for left-hand drive vehicles

Length [mm]  
Required quantity  
Thread Size 1  
Thread Size 2

480  
1  
M10x1  
M10x1

**References**

BMW 1 124 232  
BMW 1 127 136  
BMW 1 129 014  
BMW 32 21 1 124 232  
BMW 32 21 1 127 136  
BMW 32 21 1 129 014

BMW 1 124 906  
BMW 1 127 272  
BMW 1 129 015  
BMW 32 21 1 124 906  
BMW 32 21 1 127 272  
BMW 32 21 1 129 015

**Application info**

BMW 5 (E28) (05/81-12/87)

BMW 6 (E24) (10/75-04/89)

**Drag link****316 040 4331****MDL0073****Notes**

Front Axle middle  
Guide Rod  
for left-hand drive vehicles

Length [mm]  
Required quantity  
Thread Size 1  
Thread Size 2

534  
1  
M10x1  
M10x1

**References**

BMW 1 130 661  
BMW 1 136 685  
BMW 1 138 864  
BMW 32 21 1 133 615  
BMW 32 21 1 138 854

BMW 1 133 615  
BMW 1 138 854  
BMW 32 21 1 130 661  
BMW 32 21 1 136 685  
BMW 32 21 1 138 864

**Application info**

BMW 5 (E34) (02/87-07/96)

**Drag link**

316 040 4349

MDL0075

**Notes**

Front Axle middle  
Guide Rod  
for left-hand drive vehicles

Length [mm]

889

Required quantity

1

Thread Size 1

M12x1,5

Thread Size 2

M12x1,5

**References**

BMW 1 091 913

BMW 1 091 917

BMW 1 093 433

BMW 1 093 435

BMW 1 096 057

BMW 32 21 1 091 913

BMW 32 21 1 091 917

BMW 32 21 1 093 433

BMW 32 21 1 093 435

BMW 32 21 1 096 057

**Application info**

BMW 7 (E38) (03/94-11/01)

**Drag link**

316 040 4353

MDL0076

**Notes**

Front Axle middle  
Guide Rod  
for right-hand drive vehicles

Length [mm]

889

Required quantity

1

Thread Size 1

M12x1,5

Thread Size 2

M12x1,5

**References**

BMW 1 091 914

BMW 1 091 918

BMW 1 093 434

BMW 1 093 436

BMW 1 096 058

BMW 32 21 1 091 914

BMW 32 21 1 091 918

BMW 32 21 1 093 434

BMW 32 21 1 093 436

BMW 32 21 1 096 058

**Application info**

BMW 7 (E38) (03/94-11/01)

**Tie rod assembly** 316 030 0001 MTA0147

**Notes**

Front Axle Left  
Front Axle Right

Required quantity 2

Thread Size 1 M14x1,5

Thread Size 2 M16x1,5

replacement in pairs recommended



**References**

BMW 32 10 6 774 360	BMW 32 10 6 777 268
BMW 32 21 6 756 368	BMW 6 756 368
BMW 6 774 360	BMW 6 777 268

**Application info**

BMW 7 (E65, E66) (07/01-12/09)

**Tie rod assembly** 316 030 0004 MTA0148

**Notes**

Front Axle Left

Paired article number 316 030 0005 | MTA0149

Required quantity 1

Thread Size 1 M12x1,5

Thread Size 2 M18x1,5

replacement in pairs recommended



**References**

BMW 1 095 955	BMW 1 096 897
BMW 32 10 6 774 222	BMW 32 10 6 777 503
BMW 32 21 1 095 955	BMW 32 21 1 096 897
BMW 6 774 222	BMW 6 777 503
BMW (Brilliance) 1 095 955	BMW (Brilliance) 1 096 897
BMW (Brilliance) 32 10 6 774 222	BMW (Brilliance) 32 10 6 777 503
BMW (Brilliance) 32 21 1 095 955	BMW (Brilliance) 32 21 1 096 897
BMW (Brilliance) 6 774 222	BMW (Brilliance) 6 777 503

**Application info**

BMW 3 (E46) (12/97-12/07)  
 BMW Z4 (E86) (03/06-01/09)

BMW Z4 (E85) (09/02-12/09)

**Tie rod assembly**

316 030 0005

MTA0149

**Notes**

Front Axle Right  
 Paired article number 316 030 0004 | MTA0148  
 Required quantity 1  
 Thread Size 1 M12x1,5  
 Thread Size 2 M18x1,5  
 replacement in pairs recommended



**References**

BMW 1 095 956  
 BMW 32 10 6 774 223  
 BMW 32 21 1 095 956  
 BMW 6 774 223  
 BMW (Brilliance) 1 095 956  
 BMW (Brilliance) 32 10 6 774 223  
 BMW (Brilliance) 32 21 1 095 956  
 BMW (Brilliance) 6 774 223

BMW 1 096 898  
 BMW 32 10 6 777 504  
 BMW 32 21 1 096 898  
 BMW 6 777 504  
 BMW (Brilliance) 1 096 898  
 BMW (Brilliance) 32 10 6 777 504  
 BMW (Brilliance) 32 21 1 096 898  
 BMW (Brilliance) 6 777 504

**Application info**

BMW 3 (E46) (12/97-12/07)  
 BMW Z4 (E86) (03/06-01/09)

BMW Z4 (E85) (09/02-12/09)

**Tie rod assembly**

316 030 0006

MTA0150

**Notes**

Front Axle Left  
 Paired article number 316 030 0024 | MTA0168  
 Required quantity 1  
 Thread Size 1 M12x1,5  
 Thread Size 2 M18x1,5  
 replacement in pairs recommended



**References**

BMW 32 10 6 774 318  
BMW 6 751 039

BMW 32 21 6 751 039  
BMW 6 774 318

**Application info**

BMW 3 (E46) (12/97-12/07)

**Tie rod assembly**

316 030 0009

MTA0153

**Notes**

Front Axle Left  
Front Axle Right

Required quantity 2  
Thread Size 1 M14x1,5  
Thread Size 2 M18x1,5  
replacement in pairs recommended



**References**

BMW 3 412 798  
BMW 3 444 999  
BMW 32 10 3 444 999

BMW 3 418 204  
BMW 32 10 3 412 798  
BMW 32 30 3 418 204

**Application info**

BMW X3 (E83) (01/03-12/11)

**Tie rod assembly**

316 030 0010/HD

MTA0154HD

**Notes**

Carbon Neutral  
Front Axle Left  
Front Axle Right

Required quantity 2  
Thread Size 1 M14x1,5  
Thread Size 2 M14x1,5  
reinforced version  
replacement in pairs recommended



**References**

BMW 32 10 6 774 336  
BMW 32 21 6 760 470  
BMW 6 760 470

BMW 32 21 6 751 277  
BMW 6 751 277  
BMW 6 774 336

**Application info**

BMW X5 (E53) (01/00-12/06)

**Tie rod assembly**

316 030 0011

MTA0155

**Notes**

Front Axle Left  
Front Axle Right

Required quantity

2

Thread Size 1

M14x1,5

Thread Size 2

M18x1,5

replacement in pairs recommended



**References**

BMW 32 10 6 774 347

BMW 32 10 6 777 479

BMW 32 21 6 762 403

BMW 6 762 403

BMW 6 774 347

BMW 6 777 479

BMW (Brilliance) 32 10 6 774 347

BMW (Brilliance) 32 10 6 777 479

BMW (Brilliance) 32 21 6 762 403

BMW (Brilliance) 6 762 403

BMW (Brilliance) 6 774 347

BMW (Brilliance) 6 777 479

**Application info**

BMW 5 (E60, E61) (12/01-12/10)

BMW 6 (E63, E64) (09/03-12/10)

**Tie rod assembly**

316 030 0012/HD

MTA0156HD

**Notes**

Carbon Neutral  
Front Axle Left

Manufacturer Restriction

TRW

Paired article number

316 030 0013/HD | MTA0157HD

Required quantity

1

Thread Size 1

M14x1,5

Thread Size 2

M18x1,5

reinforced version

replacement in pairs recommended



**References**

BMW 32 21 6 762 243

BMW 6 762 243

BMW (Brilliance) 32 21 6 762 243

BMW (Brilliance) 6 762 243



**Application info**

BMW 1 (E81, E82, E87, E88) (02/03-12/13)

BMW 3 (E90, E91, E92, E93) (02/04-12/13)

BMW X1 (E84) (03/09-06/15)

**Tie rod assembly****316 030 0013/HD****MTA0157HD****Notes**Carbon Neutral  
Front Axle Right

Manufacturer Restriction

TRW

Paired article number

316 030 0012/HD | MTA0156HD

Required quantity

1

Thread Size 1

M14x1,5

Thread Size 2

M18x1,5

reinforced version

replacement in pairs recommended

**References**

BMW 32 21 6 762 244

BMW 6 762 244

BMW (Brilliance) 32 21 6 762 244

BMW (Brilliance) 6 762 244

**Application info**

BMW 1 (E81, E82, E87, E88) (02/03-12/13)

BMW 3 (E90, E91, E92, E93) (02/04-12/13)

BMW X1 (E84) (03/09-06/15)

**Tie rod assembly****316 030 0014****MTA0158****Notes**

Front Axle Left

Paired article number

316 030 0015 | MTA0159

Required quantity

1

Thread Size 1

M14x1,5

Thread Size 2

M18x1,5

replacement in pairs recommended

**References**

BMW 32 10 6 768 879

BMW 32 10 6 793 621

BMW 6 768 879

BMW 6 793 621

BMW (Brilliance) 32 10 6 768 879

BMW (Brilliance) 32 10 6 793 621

BMW (Brilliance) 6 768 879

BMW (Brilliance) 6 793 621

**Application info**

BMW 3 (E90, E91, E92, E93) (02/04-12/13)

BMW X1 (E84) (03/09-06/15)

**Tie rod assembly** **316 030 0015** **MTA0159**

**Notes**

Front Axle Right  
 Paired article number 316 030 0014 | MTA0158  
 Required quantity 1  
 Thread Size 1 M14x1,5  
 Thread Size 2 M18x1,5  
 replacement in pairs recommended



**References**

BMW 32 10 6 768 880	BMW 32 10 6 793 622
BMW 6 768 880	BMW 6 793 622
BMW (Brilliance) 32 10 6 768 880	BMW (Brilliance) 32 10 6 793 622
BMW (Brilliance) 6 768 880	BMW (Brilliance) 6 793 622

**Application info**

BMW 3 (E90, E91, E92, E93) (02/04-12/13)	BMW X1 (E84) (03/09-06/15)
--	----------------------------

**Tie rod assembly** **316 030 0016** **MTA0160**

**Notes**

Front Axle Left  
 Front Axle Right  
 Required quantity 2  
 Thread Size 1 M14x1,5  
 Thread Size 2 M18x1,5  
 replacement in pairs recommended







**References**

BMW 32 21 6 767 861	BMW 32 21 6 777 451
BMW 6 767 861	BMW 6 777 451

**Application info**

BMW 5 (E60, E61) (12/01-12/10)

Tie rod assembly		316 030 0017/HD	MTA0161HD
<b>Notes</b>  Carbon Neutral Front Axle Left Manufacturer Restriction ZF Paired article number 316 030 0018/HD   MTA0162HD Required quantity 1 Thread Size 1 M14x1,5 Thread Size 2 M18x1,5 reinforced version replacement in pairs recommended			
<b>References</b> BMW 32 10 6 765 235 BMW 6 765 235 BMW (Brilliance) 32 10 6 765 235 BMW (Brilliance) 6 765 235			
<b>Application info</b> BMW 1 (E81, E82, E87, E88) (02/03-12/13) BMW 3 (E90, E91, E92, E93) (02/04-12/13) BMW X1 (E84) (03/09-06/15) BMW Z4 (E89) (02/09-08/16)			
Tie rod assembly		316 030 0018/HD	MTA0162HD
<b>Notes</b>  Carbon Neutral Front Axle Right Manufacturer Restriction ZF Paired article number 316 030 0017/HD   MTA0161HD Required quantity 1 Thread Size 1 M14x1,5 Thread Size 2 M18x1,5 reinforced version replacement in pairs recommended			
<b>References</b> BMW 32 10 6 765 236 BMW 6 765 236 BMW (Brilliance) 32 10 6 765 236 BMW (Brilliance) 6 765 236			
<b>Application info</b> BMW 1 (E81, E82, E87, E88) (02/03-12/13) BMW 3 (E90, E91, E92, E93) (02/04-12/13) BMW X1 (E84) (03/09-06/15) BMW Z4 (E89) (02/09-08/16)			

Tie rod assembly		316 030 0019	MTA0163
<b>Notes</b> Paired article number Required quantity Thread Size 1 Thread Size 2 replacement in pairs recommended		Front Axle Left 316 030 0020   MTA0164 1 M10x1,25 M16x1,5	
			
<b>References</b> Mini 32 11 6 761 557 Mini 6 761 557			
Mini 32 11 6 777 521 Mini 6 777 521			
<b>Application info</b> Mini Mini I (06/01-07/08)			
Tie rod assembly		316 030 0020	MTA0164
<b>Notes</b> Paired article number Required quantity Thread Size 1 Thread Size 2 replacement in pairs recommended		Front Axle Right 316 030 0019   MTA0163 1 M10x1,25 M16x1,5	
			
<b>References</b> Mini 32 10 6 777 522 Mini 6 761 558			
Mini 32 11 6 761 558 Mini 6 777 522			
<b>Application info</b> Mini Mini I (06/01-07/08)			

**Tie rod assembly** **316 030 0021** **MTA0165**

**Notes**

Front Axle Left  
 Front Axle Right  
 Required quantity 2  
 Thread Size 1 M14x1,5  
 Thread Size 2 M18x1,5  
 replacement in pairs recommended



**References**

BMW 32 10 6 780 985 BMW 32 10 6 793 496  
 BMW 32 21 6 773 741 BMW 6 773 741  
 BMW 6 780 985 BMW 6 793 496

**Application info**

BMW X5 (E70) (02/06-07/13) BMW X6 (E71) (06/07-07/14)

**Tie rod assembly** **316 030 0022** **MTA0166**

**Notes**

Front Axle Left  
 Paired article number 316 030 0023 | MTA0167  
 Required quantity 1  
 Thread Size 1 M12x1,5  
 Thread Size 2 M14x1,5  
 replacement in pairs recommended



**References**

Mini 32 10 6 778 547 Mini 6 778 547

**Application info**

Mini Mini II (11/05-12/15)

**Tie rod assembly**

316 030 0023

MTA0167

**Notes**

Front Axle Right

Paired article number 316 030 0022 | MTA0166

Required quantity 1

Thread Size 1 M12x1,5

Thread Size 2 M14x1,5

replacement in pairs recommended

**References**

Mini 32 10 6 778 548

Mini 6 778 548

**Application info**

Mini Mini II (11/05-12/15)

**Tie rod assembly**

316 030 0024

MTA0168

**Notes**

Front Axle Right

Paired article number 316 030 0006 | MTA0150

Required quantity 1

Thread Size 1 M12x1,5

Thread Size 2 M18x1,5

replacement in pairs recommended

**References**

BMW 32 10 6 774 319

BMW 32 10 6 774 919

BMW 32 21 6 751 040



BMW 6 751 040

BMW 6 774 319

BMW 6 774 919

**Application info**

BMW 3 (E46) (12/97-12/07)

Tie rod assembly		316 030 3049	MTA0170
<b>Notes</b>  Front Axle Left Front Axle Right  Required quantity 2 Thread Size 1 M10x1,0 Thread Size 2 M10x1,0 replacement in pairs recommended			
<b>References</b> BMW 1 117 212 BMW 1 118 619 BMW 32 21 1 117 212 BMW 32 21 1 118 619			
<b>Application info</b> BMW 7 (E23) (05/77-04/88)			
Tie rod assembly		316 030 4339	MTA0176
<b>Notes</b>  Front Axle Left  Paired article number 316 030 4340   MTA0177 Required quantity 1 Thread Size 1 M10x1,0 Thread Size 2 M18x1,5 replacement in pairs recommended			
<b>References</b> BMW 1 139 315 BMW 1 139 317 BMW 32 11 1 139 315 BMW 32 11 1 139 317			
<b>Application info</b> BMW 3 (E36) (09/90-08/00) BMW Z3 (E36/7, E36/8) (10/95-06/03)			

## Tie rod assembly

316 030 4340

MTA0177

## Notes

Front Axle Right

Paired article number 316 030 4339 | MTA0176

Required quantity 1

Thread Size 1 M10x1,0

Thread Size 2 M18x1,5

replacement in pairs recommended



## References

BMW 1 139 316

BMW 32 11 1 139 316

## Application info

BMW 3 (E36) (09/90-08/00)

BMW Z3 (E36/7, E36/8) (10/95-06/03)

## Tie rod assembly

316 030 4354

MTA0178

## Notes

Front Axle Right

Paired article number 316 030 4355 | MTA0179

Required quantity 1

Thread Size 1 M12x1,5

Thread Size 2 M18x1,5

replacement in pairs recommended



## References

BMW 1 091 768

BMW 1 093 770

BMW 1 094 674

BMW 32 11 1 091 768

BMW 32 11 1 093 770

BMW 32 11 1 094 674

BMW 32 21 1 094 674

## Application info

BMW 5 (E39) (09/95-06/04)



**Tie rod assembly**

316 030 4355

MTA0179

**Notes**

Front Axle Left

Paired article number 316 030 4354 | MTA0178

Required quantity 1

Thread Size 1 M12x1,5

Thread Size 2 M18x1,5

replacement in pairs recommended

**References**

BMW 1 091 767

BMW 1 094 673

BMW 32 11 1 093 769

BMW 32 21 1 094 673

BMW 1 093 769

BMW 32 11 1 091 767

BMW 32 11 1 094 673

**Application info**

BMW 5 (E39) (09/95-06/04)

**Tie rod end**

316 020 0000

MTE0329

**Notes**

Front Axle Right

Length [mm] 230

Paired article number 316 020 0004 | MTE0332

Required quantity 1

Thread Size 1 M10x1,25

Thread Size 2 M14x1,5

replacement in pairs recommended



**References**

Mini 32 21 6 754 566

Mini 6 754 566

**Application info**

Mini Mini I (06/01-07/08)

Tie rod end		316 020 0002	MTE0330
<b>Notes</b>  Length [mm] 227 Paired article number 316 020 0003   MTE0331 Required quantity 1 Thread Size 1 M12x1,5 Thread Size 2 M16x1,0 replacement in pairs recommended			
<b>References</b> BMW 1 094 673 BMW 32 11 1 094 673			
<b>Application info</b> BMW 5 (E39) (09/95-06/04)			
Tie rod end		316 020 0003	MTE0331
<b>Notes</b>  Length [mm] 227 Paired article number 316 020 0002   MTE0330 Required quantity 1 Thread Size 1 M12x1,5 Thread Size 2 M16x1,0 replacement in pairs recommended			
<b>References</b> BMW 1 094 674 BMW 32 11 1 094 674			
<b>Application info</b> BMW 5 (E39) (09/95-06/04)			

**Tie rod end**

316 020 0004

MTE0332

**Notes**

	Front Axle Left
Length [mm]	230
Paired article number	316 020 0000   MTE0329
Required quantity	1
Thread Size 1	M10x1,25
Thread Size 2	M14x1,5
replacement in pairs recommended	

**References**

Mini 32 21 6 754 565

Mini 6 754 565

**Application info**

Mini Mini I (06/01-07/08)

**Tie rod end**

316 020 0005/HD

MTE0333HD

**Notes**

	Carbon Neutral
	Front Axle Left
	Front Axle Right
Length [mm]	190
Required quantity	2
Thread Size 1	M14x1,5
Thread Size 2	M14x1,5
reinforced version	
replacement in pairs recommended	

**References**

BMW 1 096 327

BMW 32 10 6 774 335

BMW 32 21 1 096 327



BMW 32 21 6 760 354



BMW 6 760 354



BMW 6 774 335

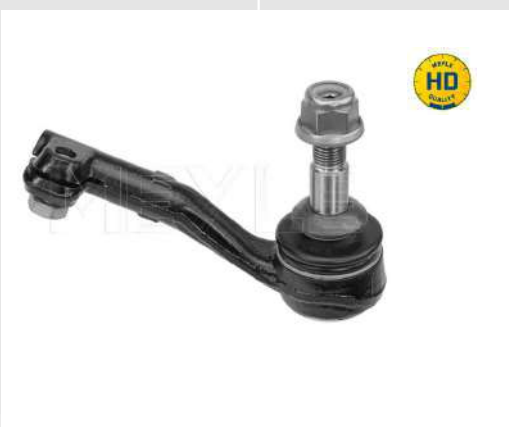

**Application info**

BMW X5 (E53) (01/00-12/06)

Tie rod end		316 020 0006	MTE0334
<b>Notes</b>  Front Axle Left Front Axle Right  Length [mm] 210 Required quantity 2 Thread Size 1 M14x1,5 Thread Size 2 M14x1,5 replacement in pairs recommended			
<b>References</b> BMW 3 413 476 BMW 3 418 202 BMW 32 30 3 418 202 BMW 32 41 3 413 476			
<b>Application info</b> BMW X3 (E83) (01/03-12/11)			
Tie rod end		316 020 0007/HD	MTE0335HD
<b>Notes</b>  Carbon Neutral Front Axle Left  Length [mm] 135 Paired article number 316 020 0008/HD   MTE0336HD Required quantity 1 Thread Size 1 M14x1,5 Thread Size 2 M14x1,5 reinforced version replacement in pairs recommended			
<b>References</b> BMW 32 10 6 765 089 BMW 32 10 6 767 781 BMW 6 765 089 BMW 6 767 781 BMW (Brilliance) 32 10 6 765 089 BMW (Brilliance) 32 10 6 767 781 BMW (Brilliance) 6 765 089 BMW (Brilliance) 6 767 781			
<b>Application info</b> BMW 1 (E81, E82, E87, E88) (02/03-12/13) BMW 3 (E90, E91, E92, E93) (02/04-12/13) BMW 3 (F30, F31) (11/11-06/19) BMW X1 (E84) (03/09-06/15) BMW Z4 (E89) (02/09-08/16)			

Tie rod end		316 020 0008/HD	MTE0336HD
<b>Notes</b>  Carbon Neutral Front Axle Right Length [mm] 135 Paired article number 316 020 0007/HD   MTE0335HD Required quantity 1 Thread Size 1 M14x1,5 Thread Size 2 M14x1,5 reinforced version replacement in pairs recommended			
<b>References</b> BMW 32 10 6 765 090 BMW 32 10 6 767 782 BMW 6 765 090 BMW 6 767 782 BMW (Brilliance) 32 10 6 765 090 BMW (Brilliance) 32 10 6 767 782 BMW (Brilliance) 6 765 090 BMW (Brilliance) 6 767 782			
<b>Application info</b> BMW 1 (E81, E82, E87, E88) (02/03-12/13) BMW 3 (E90, E91, E92, E93) (02/04-12/13) BMW 3 (F30, F31) (11/11-06/19) BMW X1 (E84) (03/09-06/15) BMW Z4 (E89) (02/09-08/16)			
Tie rod end		316 020 0009	MTE0337
<b>Notes</b>  Front Axle Right Length [mm] 110 Paired article number 316 020 0010   MTE0338 Required quantity 1 Thread Size 1 M14x1,5 Thread Size 2 M14x1,5 replacement in pairs recommended			
<b>References</b> BMW 32 10 6 769 074 BMW 32 10 6 793 624 BMW 6 769 074 BMW 6 793 624 BMW (Brilliance) 32 10 6 769 074 BMW (Brilliance) 32 10 6 793 624 BMW (Brilliance) 6 769 074 BMW (Brilliance) 6 793 624			
<b>Application info</b> BMW 3 (E90, E91, E92, E93) (02/04-12/13) BMW X1 (E84) (03/09-06/15)			

Tie rod end		316 020 0010	MTE0338
<b>Notes</b>  Length [mm] 122 Paired article number 316 020 0009   MTE0337 Required quantity 1 Thread Size 1 M14x1,5 Thread Size 2 M14x1,5 replacement in pairs recommended			
<b>References</b> BMW 32 10 6 769 073 BMW 6 769 073 BMW (Brilliance) 32 10 6 769 073 BMW (Brilliance) 6 769 073		BMW 32 10 6 793 623 BMW 6 793 623 BMW (Brilliance) 32 10 6 793 623 BMW (Brilliance) 6 793 623	
<b>Application info</b> BMW 3 (E90, E91, E92, E93) (02/04-12/13)		BMW X1 (E84) (03/09-06/15)	
Tie rod end		316 020 0011	MTE0339
<b>Notes</b>  Length [mm] 156 Required quantity 2 Thread Size 1 M14x1,5 Thread Size 2 M16x1,5 replacement in pairs recommended			
<b>References</b> BMW 32 21 6 767 860		BMW 6 767 860	
<b>Application info</b> BMW 5 (E60, E61) (12/01-12/10)			

Tie rod end		316 020 0014	MTE0340
<p><b>Notes</b></p> <p>Front Axle Left</p> <p>Length [mm] 192</p> <p>Paired article number 316 020 0015   MTE0341</p> <p>Required quantity 1</p> <p>Thread Size 1 M12x1,5</p> <p>Thread Size 2 M14x1,5</p> <p>replacement in pairs recommended</p>			
<p><b>References</b></p> <p>BMW 32 10 6 774 320 BMW 32 21 6 751 041</p> <p>BMW 6 751 041 BMW 6 774 320</p>			
<p><b>Application info</b></p> <p>BMW 3 (E46) (12/97-12/07)</p>			
Tie rod end		316 020 0015	MTE0341
<p><b>Notes</b></p> <p>Front Axle Right</p> <p>Length [mm] 192</p> <p>Paired article number 316 020 0014   MTE0340</p> <p>Required quantity 1</p> <p>Thread Size 1 M12x1,5</p> <p>Thread Size 2 M14x1,5</p> <p>replacement in pairs recommended</p>			
<p><b>References</b></p> <p>BMW 32 10 6 774 321 BMW 32 21 6 751 042</p> <p>BMW 6 751 042 BMW 6 774 321</p>			
<p><b>Application info</b></p> <p>BMW 3 (E46) (12/97-12/07)</p>			

**Tie rod end** **316 020 0018** **MTE0342**

<b>Notes</b>	Front Axle Right	
Length [mm]	233	
Paired article number	316 020 0019   MTE0343	
Required quantity	1	
Thread Size 1	M10x1,25	
Thread Size 2	M14x1,5	
replacement in pairs recommended		

<b>References</b>	Mini 32 11 6 761 560	Mini 6 761 560
-------------------	----------------------	----------------

<b>Application info</b>	Mini Mini I (06/01-07/08)	
-------------------------	---------------------------	--



**Tie rod end** **316 020 0019** **MTE0343**

<b>Notes</b>	Front Axle Left	
Length [mm]	233	
Paired article number	316 020 0018   MTE0342	
Required quantity	1	
Thread Size 1	M10x1,25	
Thread Size 2	M14x1,5	
replacement in pairs recommended		

<b>References</b>	Mini 32 13 6 761 559	Mini 6 761 559
-------------------	----------------------	----------------

<b>Application info</b>	Mini Mini I (06/01-07/08)	
-------------------------	---------------------------	--



Tie rod end		316 020 0020/HD	MTE0344HD
<b>Notes</b>  Carbon Neutral Front Axle Left Front Axle Right  Length [mm] 185 Required quantity 2 Thread Size 1 M14x1,5 Thread Size 2 M14x1,5 reinforced version replacement in pairs recommended			
<b>References</b> BMW 32 10 6 780 984 BMW 32 21 6 773 739 BMW 6 780 984		BMW 32 10 6 793 497 BMW 6 773 739 BMW 6 793 497	
<b>Application info</b> BMW X5 (E70) (02/06-07/13)		BMW X6 (E71) (06/07-07/14)	
Tie rod end		316 020 0020	MTE0344
<b>Notes</b>  Front Axle Left Front Axle Right  Length [mm] 185 Required quantity 2 Thread Size 1 M14x1,5 Thread Size 2 M14x1,5 replacement in pairs recommended			
<b>References</b> BMW 32 10 6 780 984 BMW 32 21 6 773 739 BMW 6 780 984		BMW 32 10 6 793 497 BMW 6 773 739 BMW 6 793 497	
<b>Application info</b> BMW X5 (E70) (02/06-07/13)		BMW X6 (E71) (06/07-07/14)	

**Tie rod end**

316 020 0021

MTE0345

**Notes**

	Front Axle Right
Length [mm]	237
Paired article number	316 020 0022   MTE0346
Required quantity	1
Thread Size 1	M12x1,5
Thread Size 2	M14x1,5
replacement in pairs recommended	

**References**

Mini 32 10 6 778 438

Mini 6 778 438

**Application info**

Mini Mini II (11/05-12/15)

**Tie rod end**

316 020 0022

MTE0346

**Notes**

	Front Axle Left
Length [mm]	237
Paired article number	316 020 0021   MTE0345
Required quantity	1
Thread Size 1	M12x1,5
Thread Size 2	M14x1,5
replacement in pairs recommended	



**References**



Mini 32 10 6 778 437



Mini 6 778 437

**Application info**



Mini Mini II (11/05-12/15)



Tie rod end		316 020 0023	MTE0347
<b>Notes</b>  Front Axle Right Length [mm] 160 Paired article number 316 020 0024   MTE0348 Required quantity 1 Thread Size 1 M14x1,5 Thread Size 2 M14x1,5 replacement in pairs recommended			
<b>References</b> BMW 32 10 6 784 796 BMW 6 784 796 BMW (Brilliance) 32 10 6 784 796 BMW (Brilliance) 6 784 796			
<b>Application info</b> BMW 5 (F07) (01/09-02/17) BMW 5 (F10, F11) (01/09-02/17) BMW 6 (F12, F13) (12/10-10/18) BMW 7 (F01, F02, F03, F04) (02/08-12/15)			
Tie rod end		316 020 0024	MTE0348
<b>Notes</b>  Front Axle Left Length [mm] 160 Paired article number 316 020 0023   MTE0347 Required quantity 1 Thread Size 1 M14x1,5 Thread Size 2 M14x1,5 replacement in pairs recommended			
<b>References</b> BMW 32 10 6 784 790 BMW 6 784 790 BMW (Brilliance) 32 10 6 784 790 BMW (Brilliance) 6 784 790			
<b>Application info</b> BMW 5 (F07) (01/09-02/17) BMW 5 (F10, F11) (01/09-02/17) BMW 6 (F12, F13) (12/10-10/18) BMW 7 (F01, F02, F03, F04) (02/08-12/15)			

Tie rod end		316 020 0025	MTE0349
<b>Notes</b>  Front Axle Right Length [mm] 150 Paired article number 316 020 0026   MTE0350 Required quantity 1 Thread Size 1 M14x1,5 Thread Size 2 M14x1,5 replacement in pairs recommended			
<b>References</b> BMW 32 10 6 799 876 BMW 32 10 6 799 967 BMW 6 799 876 BMW 6 799 967 BMW (Brilliance) 32 10 6 799 967 BMW (Brilliance) 6 799 967			
<b>Application info</b> BMW 1 (F20, F21) (07/11--) BMW 3 (F30, F31) (11/11-06/19) BMW 4 (F32, F33, F36) (07/13--) BMW 2 (F22,F23) (10/12--) BMW 3 (F34) (07/12--)			
Tie rod end		316 020 0026	MTE0350
<b>Notes</b>  Front Axle Left Length [mm] 150 Paired article number 316 020 0025   MTE0349 Required quantity 1 Thread Size 1 M14x1,5 Thread Size 2 M14x1,5 replacement in pairs recommended			
<b>References</b> BMW 32 10 6 799 875 BMW 32 10 6 799 966 BMW 6 799 875 BMW 6 799 966 BMW (Brilliance) 32 10 6 799 966 BMW (Brilliance) 6 799 966			
<b>Application info</b> BMW 1 (F20, F21) (07/11--) BMW 3 (F30, F31) (11/11-06/19) BMW 4 (F32, F33, F36) (07/13--) BMW 2 (F22,F23) (10/12--) BMW 3 (F34) (07/12--)			

Tie rod end		316 020 0027	MTE0351
<b>Notes</b>  Front Axle Right Length [mm] 150 Paired article number 316 020 0028   MTE0352 Required quantity 1 Thread Size 1 M14x1,5 Thread Size 2 M14x1,5 replacement in pairs recommended			
<b>References</b> BMW 32 10 6 797 618 BMW 6 797 618 BMW (Brilliance) 32 10 6 797 618 BMW (Brilliance) 6 797 618			
<b>Application info</b> BMW 1 (F20, F21) (07/11--) BMW 3 (F30, F31) (11/11-06/19) BMW 4 (F32, F33, F36) (07/13--) BMW 2 (F22,F23) (10/12--) BMW 3 (F34) (07/12--)			
Tie rod end		316 020 0028	MTE0352
<b>Notes</b>  Front Axle Left Length [mm] 150 Paired article number 316 020 0027   MTE0351 Required quantity 1 Thread Size 1 M14x1,5 Thread Size 2 M14x1,5 replacement in pairs recommended			
<b>References</b> BMW 32 10 6 797 617 BMW 6 797 617			
<b>Application info</b> BMW 1 (F20, F21) (07/11--) BMW 3 (F30, F31) (11/11-06/19) BMW 4 (F32, F33, F36) (07/13--) BMW 2 (F22,F23) (10/12--) BMW 3 (F34) (07/12--)			



Tie rod end		316 020 0034/HD	MTE0744HD
<b>Notes</b>			
	Carbon Neutral		
	Front Axle Right		
Length [mm]	195		
Paired article number	316 020 0035/HD   MTE0745HD		
Required quantity	1		
Thread Size 1	14x1,5		
Thread Size 2	14x1,5		
reinforced version			
replacement in pairs recommended			
<b>References</b>			
BMW 32 10 6 858 738		BMW 32 10 6 863 860	
BMW 6 858 738		BMW 6 863 860	
<b>Application info</b>			
BMW X5 (F15) (08/13-07/18)		BMW X6 (F16) (08/14-07/19)	
Tie rod end		316 020 0035/HD	MTE0745HD
<b>Notes</b>			
	Carbon Neutral		
	Front Axle Left		
Length [mm]	195		
Paired article number	316 020 0034/HD   MTE0744HD		
Required quantity	1		
Thread Size 1	14x1,5		
Thread Size 2	14x1,5		
reinforced version			
replacement in pairs recommended			
<b>References</b>			
BMW 32 10 6 858 736		BMW 32 10 6 863 858	
BMW 6 858 736		BMW 6 863 858	
<b>Application info</b>			
BMW X5 (F15) (08/13-07/18)		BMW X6 (F16) (08/14-07/19)	

Tie rod end		316 020 0036/HD	MTE0754HD
<b>Notes</b>			
	Carbon Neutral		
	Front Axle Right		
Length [mm]	221		
Paired article number	316 020 0037/HD   MTE0755HD		
Required quantity	1		
Thread Size 1	M14x1.5		
Thread Size 2	M14x1,5		
reinforced version			
replacement in pairs recommended			
<b>References</b>			
Mini 32 10 5 A01 8C9		Mini 32 10 6 854 737	
Mini 5 A01 8C9		Mini 6 854 737	
<b>Application info</b>			
Mini Mini III (09/13--)			
Tie rod end		316 020 0037/HD	MTE0755HD
<b>Notes</b>			
	Carbon Neutral		
	Front Axle Left		
Length [mm]	221		
Paired article number	316 020 0036/HD   MTE0754HD		
Required quantity	1		
Thread Size 1	M14x1,5		
Thread Size 2	M14x1,5		
reinforced version			
replacement in pairs recommended			
<b>References</b>			
Mini 32 10 5 A01 8B9		Mini 32 10 6 854 734	
Mini 5 A01 8B9		Mini 6 854 734	
<b>Application info</b>			
Mini Mini III (09/13--)			



**Tie rod end**

316 020 0040/HD

MTE0767HD

**Notes**

Carbon Neutral  
 Front Axle Right  
 Length [mm] 235  
 Paired article number 316 020 0041/HD | MTE0768HD  
 Required quantity 1  
 Thread Size 1 14x1,5  
 Thread Size 2 14x1,5  
 reinforced version  
 replacement in pairs recommended



**References**

- |                                  |                            |
|----------------------------------|----------------------------|
| BMW 32 10 5 A01 8D4              | BMW 32 10 6 869 425        |
| BMW 5 A01 8D4                    | BMW 6 869 425              |
| BMW (Brilliance) 32 10 6 869 425 | BMW (Brilliance) 6 869 425 |
| Mini 32 10 5 A01 8D4             | Mini 32 10 6 869 425       |
| Mini 5 A01 8D4                   | Mini 6 869 425             |

**Application info**

- |   |                              |
|---|------------------------------|
| BMW 1 (F40), 2 Gran Coupe (F44) (07/19--) | BMW 1 (F52) (01/17--)        |
| BMW 2 (F45, F46) (11/13--)                | BMW X1 (F48) (11/14--)       |
| BMW X2 (F39) (11/17--)                    | Mini Countryman II (10/16--) |
| Mini Mini III (09/13--)                   |                              |

**Tie rod end**

316 020 0041/HD

MTE0768HD

**Notes**

Carbon Neutral  
 Front Axle Left  
 Length [mm] 235  
 Paired article number 316 020 0040/HD | MTE0767HD  
 Required quantity 1  
 Thread Size 1 14x1,5  
 Thread Size 2 14x1,5  
 reinforced version  
 replacement in pairs recommended



**References**

- |                                  |                            |
|----------------------------------|----------------------------|
| BMW 32 10 5 A01 8D0              | BMW 32 10 6 869 424        |
| BMW 5 A01 8D0                    | BMW 6 869 424              |
| BMW (Brilliance) 32 10 6 869 424 | BMW (Brilliance) 6 869 424 |
| Mini 32 10 5 A01 8D0             | Mini 32 10 6 869 424       |
| Mini 5 A01 8D0                   | Mini 6 869 424             |

**Application info**

BMW 1 (F40), 2 Gran Coupe (F44) (07/19--)

BMW 2 (F45, F46) (11/13--)

BMW X2 (F39) (11/17--)

Mini Mini III (09/13--)

BMW 1 (F52) (01/17--)

BMW X1 (F48) (11/14--)

Mini Countryman II (10/16--)

**Tie rod end****316 020 0042/HD****MTE0863HD****Notes**Carbon Neutral  
Front Axle Right  
with right-hand thread

Length [mm]

199

Paired article number

316 020 0043

Paired article number

316 020 0043/HD | MTE0864HD

Required quantity

1

Thread Size 1

M14x1,5

Thread Size 2

M14x1,5

reinforced version

replacement in pairs recommended

**References**

BMW 32 10 6 868 687

BMW 32 10 6 881 535

BMW 6 869 538

BMW (Brilliance) 32 10 6 885 170

BMW 32 10 6 869 538

BMW 6 868 687

BMW 6 881 535

BMW (Brilliance) 6 885 170

**Application info**

BMW 5 (G30, G31) (09/16--)

BMW 7 (G11, G12) (07/15--)

BMW 8 Gran Coupe (G16) (07/19--)

BMW 6 (G32) (06/17--)

BMW 8 (G15) (07/18--)

**Tie rod end****316 020 0043/HD****MTE0864HD****Notes**Carbon Neutral  
Front Axle Left  
with right-hand thread

Length [mm]

199

Paired article number

316 020 0042/HD | MTE0863HD

Required quantity

1

Thread Size 1

M14x1,5

Thread Size 2

M14x1,5

reinforced version

replacement in pairs recommended



**References**

BMW 32 10 6 868 685  
 BMW 32 10 6 881 534  
 BMW 6 869 536  
 BMW (Brilliance) 32 10 6 885 169

BMW 32 10 6 869 536  
 BMW 6 868 685  
 BMW 6 881 534  
 BMW (Brilliance) 6 885 169

**Application info**

BMW 5 (G30, G31) (09/16--)  
 BMW 7 (G11, G12) (07/15--)  
 BMW 8 Gran Coupe (G16) (07/19--)

BMW 6 (G32) (06/17--)  
 BMW 8 (G15) (07/18--)

**Tie rod end**

316 020 0044/HD

MTE0876HD

**Notes**

Carbon Neutral  
 Front Axle Right  
 outer  
 Length [mm] 160  
 Paired article number 316 020 0045/HD | MTE0877HD  
 Required quantity 1  
 Thread Size 1 M14x1,5  
 Thread Size 2 M14x1,5  
 reinforced version  
 replacement in pairs recommended



**References**



BMW 32 10 4 A01 9D0  
 BMW 4 A01 9D0





BMW 32 10 6 871 893  
 BMW 6 871 893



**Application info**



BMW 3 (G20, G21) (11/18--)  
 BMW X4 (G02) (04/18--)



BMW X3 (G01) (07/17--)  
 BMW iX3 (09/20--)

Tie rod end		316 020 0045/HD	MTE0877HD
<b>Notes</b>  Carbon Neutral Front Axle Left outer  Length [mm] 160 Paired article number 316 020 0044/HD   MTE0876HD Required quantity 1 Thread Size 1 M14x1,5 Thread Size 2 M14x1,5 reinforced version replacement in pairs recommended			
<b>References</b> BMW 32 10 4 A01 666 BMW 32 10 6 871 889 BMW 4 A01 666 BMW 6 871 889			
<b>Application info</b> BMW 3 (G20, G21) (11/18--) BMW X4 (G02) (04/18--) BMW X3 (G01) (07/17--) BMW iX3 (09/20--)			
Tie rod end		316 020 0046	MTE0925
<b>Notes</b>  Front Axle Right  Length [mm] 169 Paired article number 316 020 0047   MTE0926 Required quantity 1 Thread Size 1 M14x1,5 Thread Size 2 M14x1,5 replacement in pairs recommended			
<b>References</b> BMW 32 10 6 851 412 BMW 6 851 412			
<b>Application info</b> BMW i3 (08/13--)			



Tie rod end		316 020 0047	MTE0926
<b>Notes</b>  Length [mm] 169 Paired article number 316 020 0046   MTE0925 Required quantity 1 Thread Size 1 M14x1,5 Thread Size 2 M14x1,5 replacement in pairs recommended		 	
<b>References</b> BMW 32 10 6 851 411 BMW 6 851 411			
<b>Application info</b> BMW i3 (08/13-- )			
Tie rod end		316 020 0048/HD	MTE0939HD
<b>Notes</b>  Length [mm] 146.6 Paired article number 316 020 0049/HD   MTE0940HD Required quantity 1 Thread Size 1 M14x1,5 Thread Size 2 M14x1,5 reinforced version replacement in pairs recommended		 	
<b>References</b> BMW 32 10 6 880 698 BMW 6 880 698			
<b>Application info</b> BMW 2 (G42) (08/21-- ) BMW 3 (G20, G21) (11/18-- ) BMW 4 (G22, G23, G26) (07/20-- ) BMW i4 (G26) (11/21-- )			

Tie rod end		316 020 0049/HD	MTE0940HD
<b>Notes</b>			
	Carbon Neutral		
	Front Axle Left		
Length [mm]	146.6		
Paired article number	316 020 0048/HD   MTE0939HD		
Required quantity	1		
Thread Size 1	M14x1,5		
Thread Size 2	M14x1,5		
reinforced version			
replacement in pairs recommended			
<b>References</b>			
BMW 32 10 6 880 696		BMW 6 880 696	
<b>Application info</b>			
BMW 2 (G42) (08/21--)		BMW 3 (G20, G21) (11/18--)	
BMW 4 (G22, G23, G26) (07/20--)		BMW i4 (G26) (11/21--)	
Tie rod end		316 020 0050/HD	MTE0941HD
<b>Notes</b>			
	Carbon Neutral		
	Front Axle Right		
Length [mm]	177		
Paired article number	316 020 0051/HD   MTE0942HD		
Required quantity	1		
Thread Size 1	M14x1,5		
Thread Size 2	M16x1,5		
reinforced version			
replacement in pairs recommended			
<b>References</b>			
BMW 32 10 6 887 406		BMW 6 887 406	
<b>Application info</b>			
BMW X5 (G05) (08/18--)		BMW X6 (G06) (08/19--)	
BMW X7 (G07) (03/19--)			

Tie rod end		316 020 0051/HD	MTE0942HD
<b>Notes</b>  Carbon Neutral Front Axle Left Length [mm] 177 Paired article number 316 020 0050/HD   MTE0941HD Required quantity 1 Thread Size 1 M14x1,5 Thread Size 2 M16x1,5 reinforced version replacement in pairs recommended			
<b>References</b> BMW 32 10 6 887 405		BMW 6 887 405	
<b>Application info</b> BMW X5 (G05) (08/18--) BMW X7 (G07) (03/19--)		BMW X6 (G06) (08/19--)	
Tie rod end		316 020 0052	MTE0943
<b>Notes</b>  Front Axle Right Length [mm] 138 Paired article number 316 020 0053   MTE0944 Required quantity 1 Thread Size 1 M14x1,5 Thread Size 2 M16x1,5 replacement in pairs recommended			
<b>References</b> BMW 32 10 5 A38 DE8 BMW 5 A38 DE8 Toyota 45046-WAA01		BMW 32 10 6 887 402 BMW 6 887 402	
<b>Application info</b> BMW 2 (G42) (08/21--) BMW 4 (G22, G23, G26) (07/20--) BMW i4 (G26) (11/21--		BMW 3 (G20, G21) (11/18--) BMW Z4 Roadster (G29) (11/18--) Toyota Supra V (_A9_) (03/19--	

Tie rod end		316 020 0053	MTE0944
<b>Notes</b>  Front Axle Left Length [mm] 138 Paired article number 316 020 0052   MTE0943 Required quantity 1 Thread Size 1 M14x1,5 Thread Size 2 M16x1,5 replacement in pairs recommended			
<b>References</b> BMW 32 10 5A38 DE6 BMW 32 10 6 887 400 BMW 5 A38 DE6 BMW 6 887 400 Toyota 45047-WAA01			
<b>Application info</b> BMW 2 (G42) (08/21--) BMW 4 (G22, G23, G26) (07/20--) BMW i4 (G26) (11/21--) BMW 3 (G20, G21) (11/18--) BMW Z4 Roadster (G29) (11/18--) Toyota Supra V (_A9_) (03/19--)			
Tie rod end		316 020 4341	MTE0357
<b>Notes</b>  Front Axle Left Length [mm] 210 Paired article number 316 020 4344   MTE0358 Required quantity 1 Thread Size 1 M10x1,0 Thread Size 2 M14x1,5 replacement in pairs recommended			
<b>References</b> BMW 1 139 313 BMW 32 11 1 139 313			
<b>Application info</b> BMW 3 (E36) (09/90-08/00) BMW Z3 (E36/7, E36/8) (10/95-06/03)			



Tie rod end		316 020 4344	MTE0358
<b>Notes</b>  Front Axle Right Length [mm] 210 Paired article number 316 020 4341   MTE0357 Required quantity 1 Thread Size 1 M10x1,0 Thread Size 2 M14x1,5 replacement in pairs recommended			
<b>References</b> BMW 1 139 314		BMW 32 11 1 139 314	
<b>Application info</b> BMW 3 (E36) (09/90-08/00)		BMW Z3 (E36/7, E36/8) (10/95-06/03)	
Tie rod end		316 020 4350	MTE0359
<b>Notes</b>  Front Axle Left with left-hand thread Length [mm] 219 Paired article number 316 020 4351   MTE0360 Required quantity 1 Thread Size 1 M12x1,5 Thread Size 2 M16x1,5 replacement in pairs recommended			
<b>References</b> BMW 1 141 345		BMW 32 21 1 141 345	
<b>Application info</b> BMW 7 (E38) (03/94-11/01)			

## Tie rod end

316 020 4351

MTE0360

## Notes

Front Axle Right  
with right-hand thread

Length [mm] 219

Paired article number 316 020 4350 | MTE0359

Required quantity 1

Thread Size 1 M12x1,5

Thread Size 2 M16x1,5

replacement in pairs recommended



## References

BMW 1 141 346

BMW 32 21 1 141 346

## Application info

BMW 7 (E38) (03/94-11/01)

## Tie rod end

316 020 4374

MTE0361

## Notes

Front Axle Right

Length [mm] 230

Paired article number 316 020 4375 | MTE0362

Required quantity 1

Thread Size 1 M12x1,5

Thread Size 2 M16x1,5

replacement in pairs recommended



## References

BMW 1 091 724

BMW 1 091 770

BMW 1 094 676

BMW 32 11 1 091 770

BMW 32 11 1 094 676

BMW 32 21 1 091 724

## Application info

BMW 5 (E39) (09/95-06/04)

## Tie rod end

316 020 4375

MTE0362

## Notes

Front Axle Left

Length [mm]

220

Paired article number

316 020 4374 | MTE0361

Required quantity

1

Thread Size 1

M12x1,5

Thread Size 2

M16x1,5

replacement in pairs recommended



## References

BMW 1 091 723

BMW 32 21 1 091 723

## Application info

BMW 5 (E39) (09/95-06/04)

## Tie rod end

316 020 4603

MTE0363

## Notes

Front Axle Left

Length [mm]

242

Paired article number

316 020 4604 | MTE0364

Required quantity

1

Thread Size 1

M12x1,5

Thread Size 2

M14x1,5

replacement in pairs recommended



## References

BMW 1 095 957

BMW 32 10 6 774 220

BMW 32 21 1 095 957

BMW 6 774 220

BMW (Brilliance) 1 095 957

BMW (Brilliance) 32 10 6 774 220

BMW (Brilliance) 32 21 1 095 957

BMW (Brilliance) 6 774 220

## Application info

BMW 3 (E46) (12/97-12/07)

BMW Z4 (E85) (09/02-12/09)

BMW Z4 (E86) (03/06-01/09)

**Tie rod end** **316 020 4604** **MTE0364**

**Notes**

Front Axle Right  
 Length [mm] 242  
 Paired article number 316 020 4603 | MTE0363  
 Required quantity 1  
 Thread Size 1 M12x1,5  
 Thread Size 2 M14x1,5  
 replacement in pairs recommended



**References**

BMW 1 095 958	BMW 32 10 6 774 221
BMW 32 21 1 095 958	BMW 6 774 221
BMW (Brilliance) 1 095 958	BMW (Brilliance) 32 10 6 774 221
BMW (Brilliance) 32 21 1 095 958	BMW (Brilliance) 6 774 221

**Application info**

BMW 3 (E46) (12/97-12/07)	BMW Z4 (E85) (09/02-12/09)
BMW Z4 (E86) (03/06-01/09)	

**Tie rod end** **316 030 0002** **MTE0365**

**Notes**

Front Axle Left  
 Front Axle Right  
 Length [mm] 156  
 Required quantity 2  
 Thread Size 1 M14x1,5  
 Thread Size 2 M16x1,5  
 replacement in pairs recommended



**References**

BMW 32 10 6 774 361	BMW 32 10 6 776 946
BMW 32 21 6 756 369	BMW 6 756 369
BMW 6 774 361	BMW 6 776 946
BMW (Brilliance) 32 10 6 774 361	BMW (Brilliance) 32 10 6 776 946
BMW (Brilliance) 32 21 6 756 369	BMW (Brilliance) 6 756 369
BMW (Brilliance) 6 774 361	BMW (Brilliance) 6 776 946

**Application info**

BMW 5 (E60, E61) (12/01-12/10)

BMW 7 (E65, E66) (07/01-12/09)

BMW 6 (E63, E64) (09/03-12/10)

**Tie rod end****32-16 020 0000****MTE0366****Notes**Front Axle Left  
Front Axle Right

Length [mm]

78

Required quantity

2

Thread Size 1

M10x1,5

Thread Size 2

M14x1,5

replacement in pairs recommended

**References**

Citroën 16 075 024 80

Mitsubishi 4422A018

Peugeot 16 07 502 480

Citroën 3817.74

Mitsubishi 4422A052

Peugeot 3817.74

**Application info**

Citroën C-Crosser (02/07--)

Mitsubishi ASX I (11/09--)

Mitsubishi Outlander II (11/06-12/12)

Peugeot 4008 (05/12--)

Citroën C4 AIRCROSS (08/10--)

Mitsubishi Lancer VIII (03/07--)

Peugeot 4007 (02/07-03/13)

**Tie rod end****32-16 020 0040/HD****MTE0972HD****Notes**Front Axle Right  
outer

Length [mm]

194

Observe service information

Paired article number

32-16 020 0041/HD | MTE0973HD

Required quantity

1

Thread Size 1

M12x1,25

Thread Size 2

M16x1,5

replacement in pairs recommended

**References**

Mitsubishi 4422A038

**Application info**

Mitsubishi Pajero IV (10/06--)

## Tie rod end

32-16 020 0041/HD

MTE0973HD

## Notes

Front Axle Left

Length [mm]

194

Paired article number

32-16 020 0040/HD | MTE0972HD

Required quantity

1

Thread Size 1

M12x1,25

Thread Size 2

M16x1,5

reinforced version

replacement in pairs recommended



## References

Mitsubishi 4422A037

## Application info

Mitsubishi Pajero IV (10/06--)

## Tie rod end

32-16 020 0042

MTE0989

## Notes

Front Axle Left

Front Axle Right

Length [mm]

78

Required quantity

2

Thread Size 1

12x1,25

Thread Size 2

14x1,5

replacement in pairs recommended







## References

Mitsubishi 4422A139



## Application info





Mitsubishi Eclipse Cross (10/17--)

Tie rod end		33-16 020 0014	MTE0376
<b>Notes</b>  Front Axle Left Front Axle Right  Length [mm] 74 Required quantity 2 Thread Size 1 M12x1,25 Thread Size 2 M12x1,25 replacement in pairs recommended			
<b>References</b> Suzuki 48810-84000 Suzuki 48810-84001 Suzuki 48810-M84030 Suzuki 48810M84010			
<b>Application info</b> Suzuki Alto II (EC), III (EF), IV (FF) (10/93-12/09)			
Tie rod end		33-16 020 0026	MTE0786
<b>Notes</b>  Front Axle Right outer  Length [mm] 189 Paired article number 33-16 020 0027   MTE0787 Required quantity 1 Thread Size 1 12x1,25 Thread Size 2 14,1,5 replacement in pairs recommended			
<b>References</b> Suzuki 48810-68L00			
<b>Application info</b> Suzuki Swift IV (10/10--)			

Tie rod end		33-16 020 0027	MTE0787
<b>Notes</b>  Front Axle Left outer Length [mm] 189 Paired article number 33-16 020 0026   MTE0786 Required quantity 1 Thread Size 1 12x1,25 Thread Size 2 14x1,5 replacement in pairs recommended			
<b>References</b> Suzuki 48820-68L00			
<b>Application info</b> Suzuki Swift IV (10/10--)			
Tie rod end		33-16 020 0028	MTE0788
<b>Notes</b>  Front Axle Left Front Axle Right outer Length [mm] 83 Required quantity 2 Thread Size 1 12x1,25 Thread Size 2 14x1,5 replacement in pairs recommended			
<b>References</b> Suzuki 48810M68P00			
<b>Application info</b> Suzuki Baleno II (02/16--)			



Tie rod end		33-16 020 0029	MTE0905
<b>Notes</b>  Length [mm] 71 Paired article number 33-16 020 0030   MTE0906 Required quantity 1 Thread Size 1 M12x1,25 Thread Size 2 M14x1,5 replacement in pairs recommended			
<b>References</b> Suzuki 48820-62R00 Suzuki 48820-62R01			
<b>Application info</b> Suzuki Ignis III (MF) (10/16--)			
Tie rod end		33-16 020 0030	MTE0906
<b>Notes</b>  Length [mm] 71 Paired article number 33-16 020 0029   MTE0905 Required quantity 1 Thread Size 1 M12x1,25 Thread Size 2 M14x1,5 replacement in pairs recommended			
<b>References</b> Suzuki 48810-62R00 Suzuki 48810-62R01			
<b>Application info</b> Suzuki Ignis III (MF) (10/16--)			

Tie rod end		35-16 020 0005	MTE0716
<b>Notes</b>  Front Axle Left Front Axle Right  Length [mm] 165 Required quantity 2 Thread Size 1 M12x1,25 Thread Size 2 M14x1,5 replacement in pairs recommended		 	
<b>References</b> Mazda NE51-32 280A			
<b>Application info</b> Mazda MX-5 (NC) (03/05-12/14)			
Tie rod end		35-16 020 0020/HD	MTE0733HD
<b>Notes</b>  Carbon Neutral Front Axle Left Front Axle Right  Length [mm] 100 Required quantity 2 Thread Size 1 M12x1,25 Thread Size 2 M14x1,5 reinforced version replacement in pairs recommended		 	
<b>References</b> Mazda KD31-32-280			
<b>Application info</b> Mazda CX-5 I (KE) (11/11-02/17)			

## Tie rod end

35-16 020 0029

MTE0385

## Notes

Front Axle Left  
 Length [mm] 107  
 Paired article number 35-16 020 0031 | MTE0386  
 Required quantity 1  
 Thread Size 1 M10x1,25  
 Thread Size 2 M17x1,5  
 replacement in pairs recommended



## References

Mazda BP4L-32-290

## Application info

Mazda 3 (BK) (09/99-12/09)  
 Mazda 5 (CR) (02/05-12/10)

Mazda 3 (BL) (12/08-12/14)  
 Mazda 5 (CW) (06/10--)

## Tie rod end

35-16 020 0031

MTE0386

## Notes

Front Axle Right  
 Length [mm] 107  
 Paired article number 35-16 020 0029 | MTE0385  
 Required quantity 1  
 Thread Size 1 M10x1,25  
 Thread Size 2 M17x1,5  
 replacement in pairs recommended





## References



Mazda BP4L-32-280

## Application info

Mazda 3 (BK) (09/99-12/09)  
 Mazda 5 (CR) (02/05-12/10)

Mazda 3 (BL) (12/08-12/14)  
 Mazda 5 (CW) (06/10--)

Tie rod end		35-16 020 0039	MTE0391
<b>Notes</b>  Front Axle Left Length [mm] 175 Paired article number 35-16 020 0040   MTE0392 Required quantity 1 Thread Size 1 M12x1,25 Thread Size 2 M14x1,5 replacement in pairs recommended			
<b>References</b> Mazda D651-32-290 Mazda D653-32-290 Mazda D654-32-290			
<b>Application info</b> Mazda 2 (DE) (07/07-06/15)			
Tie rod end		35-16 020 0040	MTE0392
<b>Notes</b>  Front Axle Right Length [mm] 175 Paired article number 35-16 020 0039   MTE0391 Required quantity 1 Thread Size 1 M12x1,25 Thread Size 2 M14x1,5 replacement in pairs recommended			
<b>References</b> Mazda D651-32-280 Mazda D653-32-280 Mazda D654-32-280			
<b>Application info</b> Mazda 2 (DE) (07/07-06/15)			

Tie rod end		35-16 020 0044	MTE0846
<b>Notes</b>  Front Axle Right outer Length [mm] 207 Paired article number 35-16 020 0045   MTE0847 Required quantity 1 Thread Size 1 M12x1,25 Thread Size 2 M14x1,5 replacement in pairs recommended			
<b>References</b> Mazda GS1D-32-280			
<b>Application info</b> Mazda 6 (GH) (08/07-12/13)			
Tie rod end		35-16 020 0045	MTE0847
<b>Notes</b>  Front Axle Left outer Length [mm] 207 Paired article number 35-16 020 0044   MTE0846 Required quantity 1 Thread Size 1 M12x1,25 Thread Size 2 M14x1,5 replacement in pairs recommended			
<b>References</b> Mazda GS1D-32-290			
<b>Application info</b> Mazda 6 (GH) (08/07-12/13)			

## Tie rod end

35-16 020 0046

MTE0797

## Notes

Front Axle Right  
outer  
Length [mm] 181  
Paired article number 35-16 020 0047 | MTE0798  
Required quantity 1  
Thread Size 1 12x1,25  
Thread Size 2 14x1,5  
replacement in pairs recommended



## References

Mazda BCKA-32-280 Mazda BJS8-32-280  
Mazda BJS8-32-280A Mazda GBEF-32-280  
Mazda GHT2-32-280 Mazda GHT2-32-280A

## Application info

Mazda 3 (BM) (07/13--)

Mazda 6 (GJ) (08/12--)

## Tie rod end

35-16 020 0047

MTE0798

## Notes

Front Axle Left  
outer  
Length [mm] 181  
Paired article number 35-16 020 0046 | MTE0797  
Required quantity 1  
Thread Size 1 12x1,25  
Thread Size 2 14x1,5  
replacement in pairs recommended





## References



Mazda BCKA-32-290 Mazda BJS7-32-290A  
Mazda BJS8-32-290 Mazda BJS8-32-290A  
Mazda GBEF-32-290 Mazda GHT2-32-290  
Mazda GHT2-32-290A Mazda GJR9-32-290

## Application info





Mazda 3 (BM) (07/13--)



Mazda 6 (GJ) (08/12--)

Tie rod end		35-16 020 0050	MTE0809
<b>Notes</b>  Front Axle Right outer Length [mm] 181 Paired article number 35-16 020 0051   MTE0810 Required quantity 1 Thread Size 1 12x1,5 Thread Size 2 14x1,5 replacement in pairs recommended			
<b>References</b> Mazda D09H-32-280 Mazda DA6T-32-280 Mazda DA8A-32-280 Mazda DA8A-32-280A Toyota 45046-WB001 Toyota 45046-WB002			
<b>Application info</b> Mazda 2 (DJ) (08/14-- )			
Tie rod end		35-16 020 0051	MTE0810
<b>Notes</b>  Front Axle Left Length [mm] 181 Paired article number 35-16 020 0050   MTE0809 Required quantity 1 Thread Size 1 12x1,5 Thread Size 2 14x1,5 replacement in pairs recommended			
<b>References</b> Mazda D09H-32-290 Mazda DA6T-32-290 Mazda DA8A-32-290 Mazda DA8A-32-290A Toyota 45047-WB001 Toyota 45047-WB002			
<b>Application info</b> Mazda 2 (DJ) (08/14-- )			

Tie rod end		35-16 020 0052	MTE0774
<b>Notes</b>  Front Axle Left Front Axle Right outer  Length [mm] 147 Required quantity 2 Thread Size 1 12x1,25 Thread Size 2 14x1,5 replacement in pairs recommended			
<b>References</b> Mazda D10E-32-280			
<b>Application info</b> Mazda CX-3 (DK) (01/15--)			
Tie rod end		35-16 020 0053/HD	MTE0874HD
<b>Notes</b>  Carbon Neutral Front Axle Left Front Axle Right  Length [mm] 147 Observe service information Required quantity 2 Thread Size 1 M12x1,25 Thread Size 2 M14x1,5 replacement in pairs recommended			
<b>References</b> Mazda K123-32-280			
<b>Application info</b> Mazda CX-5 II (KF) (11/16--)			



Tie rod end		35-16 020 0054	MTE0917
<b>Notes</b>  Front Axle Left Front Axle Right  Length [mm] 161 Required quantity 2 Thread Size 1 M12x1.5 Thread Size 2 M14x1.5 replacement in pairs recommended		 	
<b>References</b> ABARTH 6000612383 Mazda N243-32-280		Fiat 6000612383	
<b>Application info</b> ABARTH 124 Spider (348_) (03/16--) Mazda MX-5 (ND) (04/15--)		Fiat 124 Spider (348) (03/16--)	
Tie rod end		36-16 020 0008	MTE0393
<b>Notes</b>  Front Axle Left Front Axle Right with right-hand thread  Length [mm] 134 Required quantity 2 Thread Size 1 M12x1,25 Thread Size 2 M16x1,5 replacement in pairs recommended		 	
<b>References</b> Ford 1 961 668 Nissan 48520-61G25		Nissan 48520-31G25 Nissan 48520-7F000	
<b>Application info</b> Ford Maverick I (02/93-04/98) Nissan Terrano I (07/86-02/96)		Nissan Pick Up (D21) (09/85-12/08) Nissan Terrano II (10/92-09/07)	

Tie rod end		36-16 020 0009	MTE0394
<p><b>Notes</b></p> <p>Front Axle Left Front Axle Right with left-hand thread</p> <p>Length [mm] 131 Required quantity 2 Thread Size 1 M12x1,25 Thread Size 2 M16x1,5 replacement in pairs recommended</p>			
<p><b>References</b></p> <p>Ford 1 961 669 Nissan 48521-31G25 Nissan 48570-61G25</p>		<p>Nissan 48520-7F001 Nissan 48570-31G25</p>	
<p><b>Application info</b></p> <p>Ford Maverick I (02/93-04/98) Nissan Terrano I (07/86-02/96)</p>		<p>Nissan Pick Up (D21) (09/85-12/08) Nissan Terrano II (10/92-09/07)</p>	
Tie rod end		36-16 020 0014	MTE0395
<p><b>Notes</b></p> <p>Front Axle Left</p> <p>Length [mm] 192 Paired article number 36-16 020 0015   MTE0396 Required quantity 1 Thread Size 1 M10x1,25 Thread Size 2 M12x1,25 replacement in pairs recommended</p>			
<p><b>References</b></p> <p>Nissan D8640-1KA0A Nissan D8640-4FJ0A</p>		<p>Nissan D8640-1KA0B</p>	
<p><b>Application info</b></p> <p>Nissan Juke (F15) (06/10--) Nissan Leaf II (ZE1) (08/17--) Nissan Pulsar (08/10--)</p>		<p>Nissan Leaf I (ZE0) (11/10--) Nissan NV200 (02/10--)</p>	

**Tie rod end****36-16 020 0015****MTE0396****Notes**

	Front Axle Right
Length [mm]	192
Paired article number	36-16 020 0014   MTE0395
Required quantity	1
Thread Size 1	M10x1,25
Thread Size 2	M12x1,25
replacement in pairs recommended	

**References**

Nissan D8520-1KA0A	Nissan D8520-1KA0B
Nissan D8520-4FJ0A	

**Application info**

Nissan Juke (F15) (06/10--)	Nissan Leaf I (ZE0) (11/10--)
Nissan Leaf II (ZE1) (08/17--)	Nissan NV200 (02/10--)
Nissan Pulsar (08/10--)	

**Tie rod end****36-16 020 0017****MTE0397****Notes**

	Front Axle Left
Length [mm]	183
Paired article number	36-16 020 0018   MTE0398
Required quantity	1
Thread Size 1	M14x1,5
Thread Size 2	M16x1,5
replacement in pairs recommended	

**References**

Nissan 48520-EA01J
--------------------

**Application info**

Nissan Navara (D40) (10/04--)	Nissan Pathfinder (R51) (01/05--)
-------------------------------	-----------------------------------

## Tie rod end

36-16 020 0018

MTE0398

## Notes

Front Axle Right

Length [mm]

183

Paired article number

36-16 020 0017 | MTE0397

Required quantity

1

Thread Size 1

M14x1,5

Thread Size 2

M16x1,5

replacement in pairs recommended



## References

Nissan 48640-EA01J

## Application info

Nissan Navara (D40) (10/04--)

Nissan Pathfinder (R51) (01/05--)

## Tie rod end

36-16 020 0027

MTE0399

## Notes

Length [mm]

197

Paired article number

36-16 020 0028 | MTE0400

Required quantity

1

Thread Size 1

M10x1,25

Thread Size 2

M12x1,25

replacement in pairs recommended



## References

Nissan 48640-3U025

Nissan 48647-1U61A

Nissan D8640-EW00A

## Application info



Nissan Cube (Z12) (09/07--)

Nissan Micra (K12) (03/02--)

Nissan NV200 (02/10--)

Nissan Note I (01/05-08/13)

Nissan Tiida (05/04-12/13)

Tie rod end		36-16 020 0028	MTE0400
<p><b>Notes</b></p> <p>Length [mm] 197</p> <p>Paired article number 36-16 020 0027   MTE0399</p> <p>Required quantity 1</p> <p>Thread Size 1 M10x1,25</p> <p>Thread Size 2 M12x1,25</p> <p>replacement in pairs recommended</p>			
<p><b>References</b></p> <p>Nissan 48520-3U025 Nissan 48527-1U61A</p> <p>Nissan D8520-EW00A</p>			
<p><b>Application info</b></p> <p>Nissan Cube (Z12) (09/07--)</p> <p>Nissan NV200 (02/10--)</p> <p>Nissan Tiida (05/04-12/13)</p>		<p>Nissan Micra (K12) (03/02--)</p> <p>Nissan Note I (01/05-08/13)</p>	
Tie rod end		36-16 020 0035	MTE0653
<p><b>Notes</b></p> <p>Front Axle Left</p> <p>Length [mm] 178.5</p> <p>Paired article number 36-16 020 0036   MTE0654</p> <p>Required quantity 1</p> <p>Thread Size 1 M10x1,25</p> <p>Thread Size 2 M12x1,25</p> <p>replacement in pairs recommended</p>			
<p><b>References</b></p> <p>Nissan 48647-3VU0A Nissan D8640-1HA0A</p>			
<p><b>Application info</b></p> <p>Nissan Micra (K13) (05/10--)</p>		<p>Nissan Note II (09/12--)</p>	

## Tie rod end

36-16 020 0036

MTE0654

## Notes

	Front Axle Right
Length [mm]	178.5
Paired article number	36-16 020 0035   MTE0653
Required quantity	1
Thread Size 1	M10x1,25
Thread Size 2	M12x1,25
replacement in pairs recommended	



## References

Nissan 48527-3VU0A

Nissan D8520-1HA0A

## Application info

Nissan Micra (K13) (05/10--)

Nissan Note II (09/12--)

## Tie rod end

36-16 020 0070

MTE0404

## Notes

	Front Axle Left
	Front Axle Right
Length [mm]	91
Required quantity	2
Thread Size 1	M10x1,25
Thread Size 2	M12x1,25
replacement in pairs recommended	





## References

Nissan 48520-4F125

Nissan 48520-6F625

## Application info

Nissan Micra (K11) (01/92-12/07)

Tie rod end		36-16 020 0077	MTE0405
<b>Notes</b>  Front Axle Left Front Axle Right  Length [mm] 95 Required quantity 2 Thread Size 1 M12x1,25 Thread Size 2 M12x1,25 replacement in pairs recommended			
<b>References</b> Nissan 48520-73J25 Nissan 48520-76J25 Nissan 48520-9C000 Nissan 48520-9C025			
<b>Application info</b> Nissan Primera (P10, W10) (06/90-03/98) Nissan Primera (P11, WP11) (06/96-07/02) Nissan Primera (P12, WP12) (01/02--) Nissan Serena (C23M) (06/91-09/01) Nissan Vanette (C23) (04/94-05/02)			
Tie rod end		36-16 020 0081/HD	MTE0407HD
<b>Notes</b>  Carbon Neutral Front Axle Left  Length [mm] 200 Paired article number 36-16 020 0090/HD   MTE0411HD Required quantity 1 Thread Size 1 M10x1,25 Thread Size 2 M14x1,5 reinforced version replacement in pairs recommended			
<b>References</b> Nissan 48640-AX600			
<b>Application info</b> Nissan Micra (K12) (03/02--)			

## Tie rod end

36-16 020 0090/HD

MTE0411HD

## Notes

	Carbon Neutral
	Front Axle Right
Length [mm]	200
Paired article number	36-16 020 0081/HD   MTE0407HD
Required quantity	1
Thread Size 1	M10x1,25
Thread Size 2	M14x1,5
reinforced version	
replacement in pairs recommended	



## References

Nissan 48520-AX600

## Application info

Nissan Micra (K12) (03/02--)

## Tie rod end

36-16 020 0091

MTE0412

## Notes

	Front Axle Right
Length [mm]	181
Paired article number	36-16 020 0092   MTE0413
Required quantity	1
Thread Size 1	M10x1,25
Thread Size 2	M14x1,5
replacement in pairs recommended	



## References

Nissan 48527-JD01A

Nissan D8520-JY00A

Renault 485200604R

Nissan D8520-JG00A

Nissan D8E20JG00A

Renault D8520JY00A





## Application info

Nissan Qashqai I (J10\_) (12/06-04/14)

Renault Koleos I (09/08--)

Nissan X-Trail (T31) (03/07-12/18)



Tie rod end		36-16 020 0092	MTE0413
<b>Notes</b>  Front Axle Left Length [mm] 181 Paired article number 36-16 020 0091   MTE0412 Required quantity 1 Thread Size 1 M10x1,25 Thread Size 2 M14x1,5 replacement in pairs recommended		 	
<b>References</b> Nissan 48647-JD01A Nissan D8640-JG00A Nissan D8640-JY00A Nissan D8F40JG00A Renault 485207812R Renault D8640JY00A			
<b>Application info</b> Nissan Qashqai I (J10_) (12/06-04/14) Nissan X-Trail (T31) (03/07-12/18) Renault Koleos I (09/08--)			
Tie rod end		36-16 020 0104/HD	MTE0852HD
<b>Notes</b>  Carbon Neutral Front Axle Right outer Length [mm] 207 Paired article number 36-16 020 0105/HD   MTE0853HD Required quantity 1 Thread Size 1 M10x1,25 Thread Size 2 M14x1,5 reinforced version replacement in pairs recommended		 	
<b>References</b> Nissan D8520-4BA0A Nissan D8540-4BA0B Renault 485202260R Renault 485203872R			
<b>Application info</b> Nissan X-Trail (T32) (10/13--) Renault Koleos II (08/16--)			

**Tie rod end**

36-16 020 0105/HD

MTE0853HD

**Notes**

Carbon Neutral  
Front Axle Left  
outer

Length [mm] 207  
Paired article number 36-16 020 0104/HD | MTE0852HD  
Required quantity 1  
Thread Size 1 M10x1,25  
Thread Size 2 M14x1,5  
reinforced version  
replacement in pairs recommended



**References**

Nissan D8640-4BA0A Nissan D8640-4BA0B  
Renault 485204874R Renault 485205041R

**Application info**

Nissan X-Trail (T32) (10/13--)  
Renault Koleos II (08/16--)

**Tie rod end**

36-16 020 0106

MTE0911

**Notes**

Front Axle Right

Length [mm] 194  
Paired article number 36-16 020 0107 | MTE0912  
Paired article number 36-16 020 0140  
Required quantity 1  
Thread Size 1 M10x1,25  
Thread Size 2 M12x1,25  
replacement in pairs recommended



**References**

Nissan D8520-5RB0A Nissan D8520-5RB1A

**Application info**

Nissan Micra (K14) (12/16--)

## Tie rod end

36-16 020 0107

MTE0912

## Notes

Front Axle Left  
 Length [mm] 194  
 Paired article number 36-16 020 0106 | MTE0911  
 Required quantity 1  
 Thread Size 1 M10x1,25  
 Thread Size 2 M12x1,25  
 replacement in pairs recommended



## References

Nissan D8640-5RB0A

Nissan D8640-5RB1A

## Application info

Nissan Micra (K14) (12/16--)

## Tie rod end

37-16 020 0003

MTE0415

## Notes

Front Axle Left  
 Front Axle Right  
 Length [mm] 72  
 Required quantity 2  
 Thread Size 1 M10x1,25  
 Thread Size 2 M14x1,5  
 replacement in pairs recommended



## References

Hyundai 56820-21000  
 Hyundai 56820-28520  
 Hyundai 56820-M2000  
 Mitsubishi MB006358  
 Mitsubishi MB166426  
 Mitsubishi MB192430  
 Mitsubishi MB241172  
 Mitsubishi MB564991  
 Mitsubishi MB616286  
 Mitsubishi MT142181

Hyundai 56820-21100  
 Hyundai 56820-36000  
 Kia 56820 M2000  
 Mitsubishi MB076531  
 Mitsubishi MB185441  
 Mitsubishi MB192499  
 Mitsubishi MB489434  
 Mitsubishi MB573885  
 Mitsubishi MB912519

**Application info**

Hyundai Lantra II (06/95-12/00)

Hyundai S Coupé (02/90-05/96)

Hyundai Sonata II (09/88-12/93)

Mitsubishi Eclipse I (12/89-12/95)

Mitsubishi Galant III (10/83-12/90)

Mitsubishi Galant V (11/92-12/98)

Mitsubishi Pajero Pinin (H60) (01/99-06/07)

Mitsubishi Sapporo III (06/87-08/90)

Mitsubishi Space Runner I (10/91-08/99)

Mitsubishi Space Wagon II (05/91-11/00)

Hyundai Pony (X-2) (04/89-01/95)

Hyundai Santamo (10/98-12/02)

Kia Joice (02/00--)

Mitsubishi Eclipse II (04/94-04/99)

Mitsubishi Galant IV (11/87-03/93)

Mitsubishi Galant VI (09/96-10/04)

Mitsubishi Santamo (03/99-12/04)

Mitsubishi Sigma (10/90-10/96)

Mitsubishi Space Runner II / Wagon III (07/98-12/04)

**Tie rod end****37-16 020 0005****MTE0416****Notes**

Front Axle Right

Length [mm]

168

Paired article number

37-16 020 0006 | MTE0417

Required quantity

1

Thread Size 1

M10x1,25

Thread Size 2

M16x1,5

replacement in pairs recommended

**References**

Hyundai 56820-2E900

Kia 56820 2E900

**Application info**

Hyundai Tucson I (06/04--)

Kia Sportage II (09/04--)

**Tie rod end****37-16 020 0006****MTE0417****Notes**

Front Axle Left

Length [mm]

168

Paired article number

37-16 020 0005 | MTE0416

Required quantity

1

Thread Size 1

M10x1,25

Thread Size 2

M16x1,5

replacement in pairs recommended

**References**

Hyundai 56820-2E000

Kia 56820 2E000

**Application info**

Hyundai Tucson I (06/04--)

Kia Sportage II (09/04--)

**Tie rod end****37-16 020 0012****MTE0421****Notes**Front Axle Left  
Front Axle Right

Length [mm]

72

Required quantity

2

Thread Size 1

M10x1,25

Thread Size 2

M12x1,25

replacement in pairs recommended

**References**

Hyundai 56820-0X000

Hyundai 56820-0X010

Hyundai 56820-0X900

Kia 56820 0X000

**Application info**

Hyundai i10 I (10/07--)

Kia Picanto I (04/04--)

**Tie rod end****37-16 020 0014****MTE0422****Notes**

Front Axle Left

Length [mm]

189

Paired article number

37-16 020 0015 | MTE0423

Required quantity

1

Thread Size 1

M10x1,25

Thread Size 2

M16x1,5

replacement in pairs recommended

**References**

Hyundai 56820-2K000

Kia 56820 2K000

**Application info**

Hyundai i20 I (08/08--)

Hyundai ix20 (11/10--)

Kia Soul I (01/09--)

Kia Venga (02/10--)

## Tie rod end

37-16 020 0015

MTE0423

## Notes

Front Axle Right

Length [mm]	189
Paired article number	37-16 020 0014   MTE0422
Required quantity	1
Thread Size 1	M10x1,25
Thread Size 2	M16x1,5
replacement in pairs recommended	



## References

Hyundai 56820-2K050

Kia 56820 2K050

## Application info

Hyundai i20 I (08/08--)

Hyundai ix20 (11/10--)

Kia Soul I (01/09--)

Kia Venga (02/10--)

## Tie rod end

37-16 020 0032/HD

MTE0815HD

## Notes

Carbon Neutral  
Front Axle Right  
outer

Length [mm]	202
Paired article number	37-16 020 0033/HD   MTE0816HD
Required quantity	1
Thread Size 1	10x1,25
Thread Size 2	14x1,5
reinforced version replacement in pairs recommended	



## References

Hyundai 56820-4L090

Kia 56820 4L090

## Application info

Kia Rio III (09/10--)

## Tie rod end

37-16 020 0033/HD

MTE0816HD

## Notes

Carbon Neutral  
Front Axle Left  
outer

Length [mm]

202

Paired article number

Required quantity

1

Thread Size 1

10x1,25

Thread Size 2

14x1,5

reinforced version

replacement in pairs recommended



## References

Hyundai 56820-4L000

Kia 56820 4L000

## Application info

Kia Rio III (09/10--)

## Tie rod end

37-16 020 0034

MTE0789

## Notes

Front Axle Right  
outer

Length [mm]

78

Paired article number

37-16 020 0035 | MTE0790

Required quantity

1

Thread Size 1

10x1,25

Thread Size 2

14x1,5

replacement in pairs recommended



## References

Hyundai 56821-B4050

## Application info

Hyundai i10 II (08/13--)

Hyundai i10 III (09/19--)

## Tie rod end

37-16 020 0035

MTE0790

## Notes

Front Axle Left  
outer  
Length [mm] 78  
Paired article number 37-16 020 0034 | MTE0789  
Required quantity 1  
Thread Size 1 10x1,25  
Thread Size 2 14x1,5  
replacement in pairs recommended



## References

Hyundai 56820-B4000

## Application info

Hyundai i10 II (08/13--)

Hyundai i10 III (09/19--)

## Tie rod end

37-16 020 0036/HD

MTE0813HD

## Notes

Carbon Neutral  
Front Axle Right  
outer  
Length [mm] 78  
Paired article number 37-16 020 0037/HD | MTE0814HD  
Required quantity 1  
Thread Size 1 10x1,25  
Thread Size 2 14x1,5  
reinforced version  
replacement in pairs recommended





## References

Hyundai 56820-C8900

## Application info

Hyundai i20 II (11/14--)



Tie rod end		37-16 020 0037/HD	MTE0814HD
<b>Notes</b>  Carbon Neutral Front Axle Left outer  Length [mm] 78 Paired article number 37-16 020 0036/HD   MTE0813HD Required quantity 1 Thread Size 1 10x1,25 Thread Size 2 14x1,5 reinforced version replacement in pairs recommended			
<b>References</b> Hyundai 56820-C8000			
<b>Application info</b> Hyundai i20 II (11/14--)  Hyundai Santa Fé III (09/12--) Kia Sorento II (06/09--)  Hyundai 56820-2W050 Kia 56820 2W050			
Tie rod end		37-16 020 0038/HD	MTE0799HD
<b>Notes</b>  Carbon Neutral Front Axle Right outer  Length [mm] 224 Paired article number 37-16 020 0039/HD   MTE0800HD Required quantity 1 Thread Size 1 10x1,25 Thread Size 2 16x1,5 reinforced version replacement in pairs recommended			
<b>References</b> Hyundai 56820-2W050 Kia 56820 2W050			
<b>Application info</b> Hyundai Santa Fé III (09/12--) Kia Sorento II (06/09--)  Hyundai 56820-2W050 Kia 56820 2W050			

Tie rod end

37-16 020 0039/HD

MTE0800HD

Notes

Carbon Neutral  
Front Axle Left  
outer

Length [mm] 224  
Paired article number 37-16 020 0038/HD | MTE0799HD  
Required quantity 1  
Thread Size 1 10x1,25  
Thread Size 2 16x1,5  
reinforced version  
replacement in pairs recommended



References

Hyundai 56820-2W000 Kia 56820 2W000

Application info

Hyundai Santa Fé III (09/12--) Kia Sorento II (06/09--)

Tie rod end

37-16 020 0040/HD

MTE0791HD

Notes

Carbon Neutral  
Front Axle Right  
outer

Length [mm] 186  
Paired article number 37-16 020 0041/HD | MTE0792HD  
Required quantity 1  
Thread Size 1 10x1,25  
Thread Size 2 16x1,5  
reinforced version  
replacement in pairs recommended



References

Hyundai 56825-C1090 Hyundai 56825-C1710  
Hyundai 56825-D7000 Hyundai 56825-D7500  
Kia 56825 C1090 Kia 56825 C1710  
Kia 56825 D7000 Kia 56825 D7500

Application info

Hyundai Sonata VII (06/14--) Hyundai Tucson II (05/15--)  
Kia Optima IV (09/15--) Kia Sorento III (01/15--)  
Kia Sportage IV (09/15--)

## Tie rod end

37-16 020 0041/HD

MTE0792HD

## Notes

Carbon Neutral  
Front Axle Left  
outer

Length [mm] 186  
Paired article number 37-16 020 0040/HD | MTE0791HD  
Required quantity 1  
Thread Size 1 10x1,25  
Thread Size 2 16x1,5  
reinforced version  
replacement in pairs recommended



## References

Hyundai 56820-C1000  
Hyundai 56820-D7000  
Kia 56820 C1000  
Kia 56820 D7000

Hyundai 56820-C1710  
Hyundai 56820-D7500  
Kia 56820 C1710  
Kia 56820 D7500

## Application info

Hyundai Sonata VII (06/14--)  
Kia Optima IV (09/15--)  
Kia Sportage IV (09/15--)

Hyundai Tucson II (05/15--)  
Kia Sorento III (01/15--)

## Tie rod end

37-16 020 0042/HD

MTE0793HD

## Notes

Carbon Neutral  
Front Axle Right  
outer

Length [mm] 221  
Paired article number 37-16 020 0043/HD | MTE0794HD  
Required quantity 1  
Thread Size 1 M10x1,25  
Thread Size 2 M16x1,5  
reinforced version  
replacement in pairs recommended



## References

Hyundai 56820-3X090  
Hyundai 56820-A6090  
Kia 56820 A6090  
Kia 56820-B2050

Hyundai 56820-A5090  
Hyundai 56820-A6590  
Kia 56820-A6590

**Application info**

Hyundai Elantra V (09/10--)

Hyundai i30 II (06/11--)

Kia Cee'd III (03/12--)

Hyundai Veloster I (03/11-12/17)

Kia Cee'd II (05/12--)

Kia Soul II (02/14--)

**Tie rod end****37-16 020 0043/HD****MTE0794HD****Notes**

Carbon Neutral

Front Axle Left

outer

Length [mm]

221

Paired article number

37-16 020 0042/HD | MTE0793HD

Required quantity

1

Thread Size 1

M10x1,25

Thread Size 2

M16x1,5

reinforced version

replacement in pairs recommended

**References**

Hyundai 56820-3X000

Hyundai 56820-A6000

Kia 56820 A6000

Kia 56820-B2000

Hyundai 56820-A5000

Hyundai 56820-A6500

Kia 56820-A6500

**Application info**

Hyundai Elantra V (09/10--)

Hyundai i30 II (06/11--)

Kia Cee'd III (03/12--)

Hyundai Veloster I (03/11-12/17)

Kia Cee'd II (05/12--)

Kia Soul II (02/14--)

**Tie rod end****37-16 020 0044/HD****MTE0757HD****Notes**

Carbon Neutral

Front Axle Right

Length [mm]

233

Paired article number

37-16 020 0045/HD | MTE0758HD

Required quantity

1

Thread Size 1

M10x1,25

Thread Size 2

M16x1,5

reinforced version

replacement in pairs recommended



**References**

Hyundai 56820-2S050  
Hyundai 56820-3S000  
Kia 56820 2T500

Hyundai 56820-2T500  
Kia 56820 2S050  
Kia 56820 A4050

**Application info**

Hyundai Grandeur V (01/11--)  
Hyundai Tucson I (06/04--)  
Kia Carens IV (03/13--)

Hyundai Sonata VI (06/09-12/15)  
Hyundai ix35 (08/09--)  
Kia Sportage III (09/09--)

**Tie rod end****37-16 020 0045/HD****MTE0758HD****Notes**

Carbon Neutral  
Front Axle Left

233

37-16 020 0044/HD | MTE0757HD

1

M10x1,25

M16x1,5

Length [mm]

Paired article number

Required quantity

Thread Size 1

Thread Size 2

reinforced version

replacement in pairs recommended

**References**







Hyundai 56820-2S000  
Hyundai 56820-3S500  
Kia 56820 3S500  
Kia 56825 A4050

Hyundai 56820-2T000  
Kia 56820 2T000  
Kia 56820-2S000

**Application info**

Hyundai Grandeur V (01/11--)  
Hyundai Tucson I (06/04--)  
Kia Carens IV (03/13--)

Hyundai Sonata VI (06/09-12/15)  
Hyundai ix35 (08/09--)  
Kia Sportage III (09/09--)

Tie rod end		37-16 020 0046/HD	MTE0828HD
<b>Notes</b>		Carbon Neutral Front Axle Right outer Length [mm] 233.5 Paired article number 37-16 020 0047/HD   MTE0829HD Required quantity 1 Thread Size 1 10x1,25 Thread Size 2 16x1,5 reinforced version replacement in pairs recommended	  
<b>References</b>			
Hyundai 56820-2T100 Hyundai 56820-3V400 Kia 56820 2T100 Kia 56820 3V400		Hyundai 56820-3V100 Hyundai 56820-3Z290 Kia 56820 3Q500	
<b>Application info</b>		Hyundai i40 (07/11--) Kia Optima (01/10--)	
Tie rod end		37-16 020 0047/HD	MTE0829HD
<b>Notes</b>		Carbon Neutral Front Axle Left outer Length [mm] 233.5 Paired article number 37-16 020 0046/HD   MTE0828HD Required quantity 1 Thread Size 1 10x1,25 Thread Size 2 16x1,5 reinforced version replacement in pairs recommended	  
<b>References</b>			
Hyundai 56820-2T190 Hyundai 56820-3V490 Kia 56820 2T190 Kia 56820 3V490		Hyundai 56820-3V190 Hyundai 56820-3Z200 Kia 56820 3Q000	
<b>Application info</b>		Hyundai i40 (07/11--) Kia Optima (01/10--)	

## Tie rod end

37-16 020 0052/HD

MTE0880HD

## Notes

	Carbon Neutral
	Front Axle Right
Length [mm]	120
Paired article number	37-16 020 0053/HD   MTE0881HD
Required quantity	1
Thread Size 1	10x1,25
Thread Size 2	16x1,5
reinforced version	
replacement in pairs recommended	



## References

Hyundai 56825-F2000	Hyundai 56825-J7000
Kia 56825 F2000	Kia 56825 J7000
Kia 56825 Q5000	

## Application info

Hyundai Elantra VI (09/15--)	Hyundai Kona I (06/17--)
Hyundai i30 III (11/16--)	Kia Ceed IV (03/18--)
Kia Soul III (SK3) (01/19--)	

## Tie rod end

37-16 020 0053/HD

MTE0881HD

## Notes

	Carbon Neutral
	Front Axle Left
Length [mm]	120
Paired article number	37-16 020 0052
Paired article number	37-16 020 0052/HD   MTE0880HD
Required quantity	1
Thread Size 1	10x1,25
Thread Size 2	16x1,5
reinforced version	
replacement in pairs recommended	



## References

Hyundai 56820-F2000	Hyundai 56820-J7000
Kia 56820 F2000	Kia 56820 J7000
Kia 56820 Q5000	

**Application info**

Hyundai Elantra VI (09/15--)  
 Hyundai i30 III (11/16--)  
 Kia Soul III (SK3) (01/19--)

Hyundai Kona I (06/17--)  
 Kia Ceed IV (03/18--)

**Tie rod end**

37-16 020 0054/HD

MTE0886HD

**Notes**

Carbon Neutral  
 Front Axle Right  
 Length [mm] 120  
 Paired article number 37-16 020 0055/HD | MTE0887HD  
 Required quantity 1  
 Thread Size 1 12x1,25  
 Thread Size 2 16x1,5  
 reinforced version  
 replacement in pairs recommended



**References**

Hyundai 56825-G2000  
 Hyundai 56825-J2000  
 Hyundai 56825-S0001  
 Kia 56825 G2500  
 Kia 56825 K4090

Hyundai 56825-G2500  
 Hyundai 56825-K4090  
 Kia 56825 G2000  
 Kia 56825 J2000  
 Kia 56825 S0001

**Application info**

Hyundai Ioniq (AE) (03/16--)  
 Hyundai i30 III (11/16--)  
 Kia Soul III (SK3) (01/19--)

Hyundai Kona I (06/17--)  
 Kia Niro I (DE) (09/16--)

**Tie rod end**

37-16 020 0055/HD

MTE0887HD

**Notes**

Carbon Neutral  
 Front Axle Left  
 Length [mm] 120  
 Paired article number 37-16 020 0054/HD | MTE0886HD  
 Required quantity 1  
 Thread Size 1 12x1,25  
 Thread Size 2 16x1,5  
 reinforced version  
 replacement in pairs recommended





**References**

Hyundai 56820-G2000  
 Hyundai 56820-K4000  
 Kia 56820 G2000  
 Kia 56820 J2000  
 Kia 56820 S0001

Hyundai 56820-G2500  
 Hyundai 56820-S0001  
 Kia 56820 G2500  
 Kia 56820 K4000

**Application info**

Hyundai Ioniq (AE) (03/16--)  
 Hyundai i30 III (11/16--)  
 Kia Soul III (SK3) (01/19--)

Hyundai Kona I (06/17--)  
 Kia Niro I (DE) (09/16--)

**Tie rod end**

37-16 020 0056/HD

MTE0872HD

**Notes**

Carbon Neutral  
 Front Axle Right  
 Length [mm] 78  
 Paired article number 37-16 020 0057  
 Paired article number 37-16 020 0057/HD | MTE0873HD  
 Required quantity 1  
 Thread Size 1 M10x1,25  
 Thread Size 2 M14x1,5  
 replacement in pairs recommended



**References**

Hyundai 56825-C8100

**Application info**

Hyundai i20 II (11/14--)

**Tie rod end**

37-16 020 0057/HD

MTE0873HD

**Notes**

Carbon Neutral  
 Front Axle Left  
 Length [mm] 78  
 Paired article number 37-16 020 0056/HD | MTE0872HD  
 Required quantity 1  
 Thread Size 1 M10x1,25  
 Thread Size 2 M14x1,5  
 reinforced version  
 replacement in pairs recommended



**DRIVER'S BEST FRIEND**

**MEYLE**

**References**

Hyundai 56820-C8100

**Application info**

Hyundai i20 II (11/14--)

## Suspension

## Axle support bushing

32-14 710 0003/HD

MAB0201HD

## Notes

Carbon Neutral  
Rear Axle Left  
Rear Axle Right

Height [mm]  
Outer Diameter [mm]  
Replace in pairs only  
Required quantity  
reinforced version

130  
58  
2



## References

Mitsubishi 4120A040  
Mitsubishi 4120A042  
Smart 454 350 00 08  
Smart A 454 350 00 08

Mitsubishi 4120A041  
Mitsubishi MR594101  
Smart 454 350 03 08  
Smart A 454 350 03 08

## Application info

Mitsubishi Colt VI (10/02-12/12)

Smart Forfour (01/04-06/06)

## Axle support bushing

32-14 710 0005

MAB0203

## Notes

Front  
Lower  
Rear Axle Left  
Rear Axle Right

Height [mm]  
Outer Diameter [mm]  
Required quantity  
replacement in pairs recommended

126  
70  
2



## References

Citroën 16 118 561 80  
Citroën 5131.H5  
Mitsubishi 4120A181  
Peugeot 5131 G0

Citroën 5131.G0  
Mitsubishi 4120A125  
Peugeot 16 11 856 180  
Peugeot 5131.H5

**Application info**

Citroën C-Crosser (02/07--)  
 Mitsubishi ASX I (11/09--)  
 Mitsubishi Lancer VIII (03/07--)  
 Peugeot 4007 (02/07-03/13)

Citroën C4 AIRCROSS (08/10--)  
 Mitsubishi Lancer VII (03/00-12/13)  
 Mitsubishi Outlander II (11/06-12/12)  
 Peugeot 4008 (05/12--)

**Axle support bushing****34-16 010 0006****MBJ0474****Notes**

Rear Axle Left  
 Rear Axle Right  
 Rubber/Metal

Height [mm] 50  
 Inner Diameter [mm] 12  
 Outer Diameter [mm] 40  
 Required quantity 2  
 replacement in pairs recommended

**References**

Subaru 20257XA000

**Application info**

Subaru BRZ (06/12--)  
 Subaru Forester IV (SJ) (11/12--)  
 Subaru Impreza III (GR) (01/07--)  
 Subaru Impreza V (GT) (10/16--)  
 Subaru Legacy VI (BN, BS) (01/15--)  
 Subaru Outback IV (BM, BR) (06/09--)  
 Subaru Tribeca (B9) (01/05--)  
 Subaru XV I (09/11--)

Subaru Forester III (SH) (12/07--)  
 Subaru Forester V (SK) (04/18--)  
 Subaru Impreza IV (GP, GJ) (07/11--)  
 Subaru Legacy V (06/08--)  
 Subaru Levorg (03/15--)  
 Subaru Outback V (10/14--)  
 Subaru WRX (GP,GJ) (07/11-12/12)  
 Subaru XV II (04/17--)

**Ball joint****316 010 0002****MBJ0178****Notes**

Front Axle Left  
 Front Axle Right  
 with accessories

Required quantity 2  
 Thread Size M14x1,5  
 replacement in pairs recommended



**References**

BMW 1 096 425

BMW 31 12 6 756 491

BMW 31 12 1 096 425

BMW 6 756 491

**Application info**

BMW X5 (E53) (01/00-12/06)

**Ball joint**

316 010 0003/HD

MBJ0179HD

**Notes**Carbon Neutral  
Front Axle Left  
Front Axle Right  
outer

Height [mm]

76

Outer Diameter [mm]

49

Required quantity

2

Thread Size

M12x1,5

reinforced version

replacement in pairs recommended

**References**

BMW 1 096 685

BMW 31 12 1 096 685

BMW 31 12 6 758 510

BMW (Brilliance) 1 096 685

BMW (Brilliance) 31 12 1 096 685

BMW (Brilliance) 31 12 6 758 510

BMW 1 140 398

BMW 31 12 1 140 398

BMW 6 758 510

BMW (Brilliance) 1 140 398

BMW (Brilliance) 31 12 1 140 398

BMW (Brilliance) 6 758 510

**Application info**



BMW 3 (E36) (09/90-08/00)

BMW Z3 (E36/7, E36/8) (10/95-06/03)

BMW Z4 (E86) (03/06-01/09)

BMW 3 (E46) (12/97-12/07)

BMW Z4 (E85) (09/02-12/09)

Ball joint		316 010 0007	MBJ0182
<p><b>Notes</b></p> <p>Front Axle Left Front Axle Right outer with accessories</p> <p>Required quantity 2 Thread Size M12x1,5 replacement in pairs recommended</p>			
<p><b>References</b></p> <p>Mini 2 167 245                                      Mini 31 12 2 167 245 Mini 31 12 6 756 309                                Mini 31 12 6 783 443 Mini 6 756 309                                        Mini 6 783 443</p>			
<p><b>Application info</b></p> <p>Mini Mini I (06/01-07/08)</p>			
Ball joint		316 010 0008	MBJ0183
<p><b>Notes</b></p> <p>Front Axle Left Front Axle Right with accessories</p> <p>Required quantity 2 Thread Size M14x1,5 replacement in pairs recommended</p>			
<p><b>References</b></p> <p>BMW 3 412 726                                        BMW 3 418 341 BMW 31 10 3 412 726                                BMW 31 10 3 418 341</p>			
<p><b>Application info</b></p> <p>BMW X3 (E83) (01/03-12/11)</p>			

**Ball joint**

316 010 0009

MBJ0184

**Notes**

Front Axle Right  
with accessories  
Paired article number 316 010 0010 | MBJ0185  
Required quantity 1  
Thread Size M12x1,5  
replacement in pairs recommended



**References**

Mini 2 361 220	Mini 31 12 2 361 220
Mini 31 12 4 048 630	Mini 31 12 6 772 304
Mini 4 048 630	Mini 6 772 304

**Application info**

Mini Mini II (11/05-12/15)

**Ball joint**

316 010 0010

MBJ0185

**Notes**

Front Axle Left  
with accessories  
Paired article number 316 010 0009 | MBJ0184  
Required quantity 1  
Thread Size M12x1,5  
replacement in pairs recommended





**References**

Mini 2 361 219	Mini 31 12 2 361 219
Mini 31 12 4 048 629	Mini 31 12 6 772 303
Mini 4 048 629	Mini 6 772 303

**Application info**

Mini Mini II (11/05-12/15)

Ball joint		316 010 0011	MBJ0186
<b>Notes</b>			
Required quantity	Front Axle Left Front Axle Right with accessories		
Thread Size	2		
replacement in pairs recommended	M14x1,5		
<b>References</b>			
BMW 0 363 476		BMW 3 438 623	
BMW 31 10 0 363 476		BMW 31 10 3 438 623	
<b>Application info</b>			
BMW X3 (E83) (01/03-12/11)			
Ball joint		316 010 0013	MBJ0392
<b>Notes</b>			
Required quantity	Front Axle Left Front Axle Right outer with accessories		
Thread Size	2		
replacement in pairs recommended	M14x1,5		
<b>References</b>			
Mini 2 444 416		Mini 31 10 9 803 662	
Mini 31 12 2 444 416		Mini 9 803 662	
<b>Application info</b>			
Mini Countryman I (08/10-10/16)		Mini Paceman (03/12-10/16)	



**Ball joint****316 010 0014****MBJ0187****Notes**

Front Axle Left  
 Front Axle Right  
 Upper  
 with accessories

Required quantity  
 only in connection with  
 replacement in pairs recommended

2  
 316 050 0044/HD

**References**

BMW 31 12 6 775 967  
 BMW 31 12 6 779 908  
 BMW 6 779 871  
 BMW (Brilliance) 31 12 6 775 967

BMW 31 12 6 779 871  
 BMW 6 775 967  
 BMW 6 779 908  
 BMW (Brilliance) 6 775 967

**Application info**

BMW 5 (F07) (01/09-02/17)  
 BMW 6 (F12, F13) (12/10-10/18)  
 BMW i8 (03/14-06/20)

BMW 5 (F10, F11) (01/09-02/17)  
 BMW 7 (F01, F02, F03, F04) (02/08-12/15)

**Ball joint****316 010 0015****MBJ0188****Notes**

Front Axle Left  
 Front Axle Right  
 with accessories

Required quantity  
 Thread Size  
 replacement in pairs recommended

2  
 M14x1,5

**References**



BMW 31 12 6 768 988  
 BMW (Brilliance) 31 12 6 768 988

BMW 6 768 988  
 BMW (Brilliance) 6 768 988

**Application info**

BMW 3 (E90, E91, E92, E93) (02/04-12/13)

BMW X1 (E84) (03/09-06/15)

Ball joint		316 010 0016	MBJ0307
<b>Notes</b>  Front Axle Left Front Axle Right  Required quantity 2 Thread Size 1 M16x1,5 Thread Size 2 M30x1,5 replacement in pairs recommended			
<b>References</b> BMW 31 12 6 777 753 BMW 6 777 753			
<b>Application info</b> BMW 5 (F07) (01/09-02/17) BMW 5 (F10, F11) (01/09-02/17) BMW 6 (F12, F13) (12/10-10/18) BMW 7 (F01, F02, F03, F04) (02/08-12/15)			
Ball joint		316 010 0017	MBJ0320
<b>Notes</b>  Front Axle Left Front Axle Right with accessories  Outer Diameter [mm] 41 Required quantity 2 Thread Size M14x1,5 replacement in pairs recommended			
<b>References</b> BMW 31 10 4 038 994 BMW 31 12 6 768 307 BMW 31 12 6 772 138 BMW 31 12 6 779 840 BMW 4 038 994 BMW 6 768 307 BMW 6 772 138 BMW 6 779 840			
<b>Application info</b> BMW 5 (E60, E61) (12/01-12/10)			

**Ball joint** **316 010 0018** **MBJ0393**

**Notes**

Front Axle Left  
Front Axle Right  
with accessories

Required quantity 2  
Thread Size M14x1,5  
replacement in pairs recommended



**References**

BMW 31 10 6 787 665

BMW 6 787 665

**Application info**

BMW X3 (F25) (09/10-08/17)

BMW X4 (F26) (05/13-03/18)

**Ball joint** **316 010 0019/HD** **MBJ0438HD**

**Notes**

Carbon Neutral  
Front Axle Left  
Front Axle Right  
Upper  
with accessories

Required quantity 2  
only in connection with 316 050 0033/HD  
only in connection with 316 050 0034/HD  
reinforced version  
replacement in pairs recommended



**References**

BMW 31 12 6 776 417  
 BMW 31 12 6 776 995  
 BMW 31 12 6 776 997  
 BMW 31 12 6 863 333  
 BMW 31 12 6 863 335  
 BMW 31 12 6 863 785  
 BMW 6 776 417  
 BMW 6 776 995  
 BMW 6 776 997  
 BMW 6 863 333  
 BMW 6 863 335  
 BMW 6 863 785

BMW 31 12 6 776 418  
 BMW 31 12 6 776 996  
 BMW 31 12 6 776 998  
 BMW 31 12 6 863 334  
 BMW 31 12 6 863 336  
 BMW 31 12 6 863 786  
 BMW 6 776 418  
 BMW 6 776 996  
 BMW 6 776 998  
 BMW 6 863 334  
 BMW 6 863 336  
 BMW 6 863 786

**Application info**

BMW X5 (E70) (02/06-07/13)  
 BMW X6 (E71) (06/07-07/14)

BMW X5 (F15) (08/13-07/18)  
 BMW X6 (F16) (08/14-07/19)

**Ball joint****316 010 0022/HD****MBJ0452HD****Notes**

Carbon Neutral  
 Front Axle Right  
 Paired article number 316 010 0023/HD | MBJ0453HD  
 Required quantity 1  
 only in connection with 316 050 0128/HD  
 reinforced version  
 replacement in pairs recommended

**References**

BMW 2 785 114  
 BMW 31 12 6 851 204  
 BMW 31 12 6 879 844  
 BMW 6 871 302  
 Mini 2 785 114  
 Mini 31 12 6 851 204  
 Mini 31 12 6 879 844  
 Mini 6 871 302

BMW 31 12 2 785 114  
 BMW 31 12 6 871 302  
 BMW 6 851 204  
 BMW 6 879 844  
 Mini 31 12 2 785 114  
 Mini 31 12 6 871 302  
 Mini 6 851 204  
 Mini 6 879 844

**Application info**

BMW 1 (F40), 2 Gran Coupe (F44) (07/19--)  
 BMW X1 (F48) (11/14--)  
 Mini Countryman II (10/16--)

BMW 2 (F45, F46) (11/13--)  
 BMW X2 (F39) (11/17--)  
 Mini Mini III (09/13--)

**Ball joint** **316 010 0023/HD** **MBJ0453HD**

**Notes**

Carbon Neutral  
 Front Axle Left  
 Paired article number 316 010 0022/HD | MBJ0452HD  
 Required quantity 1  
 only in connection with 316 050 0127/HD  
 reinforced version  
 replacement in pairs recommended



**References**

- |                      |                      |
|----------------------|----------------------|
| BMW 2 785 113        | BMW 31 12 2 785 113  |
| BMW 31 12 6 851 203  | BMW 31 12 6 871 301  |
| BMW 31 12 6 879 843  | BMW 6 851 203        |
| BMW 6 871 301        | BMW 6 879 843        |
| Mini 2 785 113       | Mini 31 12 2 785 113 |
| Mini 31 12 6 851 203 | Mini 31 12 6 871 301 |
| Mini 31 12 6 879 843 | Mini 6 851 203       |
| Mini 6 871 301       | Mini 6 879 843       |

**Application info**

- |   |                            |
|---|----------------------------|
| BMW 1 (F40), 2 Gran Coupe (F44) (07/19--) | BMW 2 (F45, F46) (11/13--) |
| BMW X1 (F48) (11/14--)                    | BMW X2 (F39) (11/17--)     |
| Mini Countryman II (10/16--)              | Mini Mini III (09/13--)    |

**Ball joint** **316 010 0024** **MBJ0480**

**Notes**

Front Axle Left  
 Front Axle Right  
 Lower  
 for control arm  
 outer  
 Required quantity 2  
 Thread Size 1 M16x1,5  
 Thread Size 2 M30x1,5  
 replacement in pairs recommended



**References**

- |                     |               |
|---------------------|---------------|
| BMW 31 10 6 852 536 | BMW 6 852 536 |
|---------------------|---------------|

**Application info**

BMW 5 (G30, G31) (09/16--)

BMW 7 (G11, G12) (07/15--)

BMW 8 Gran Coupe (G16) (07/19--)

BMW 6 (G32) (06/17--)

BMW 8 (G15) (07/18--)

**Ball joint****316 010 4305/HD****MBJ0190HD****Notes**Carbon Neutral  
Front Axle Left  
Front Axle Right  
inner

Height [mm]

132

Outer Diameter [mm]

41

Required quantity

2

Thread Size

M14x1,5

reinforced version

replacement in pairs recommended

**References**The references of this product can be found at [www.meyle.com](http://www.meyle.com)**Application info**

BMW 3 (E46) (12/97-12/07)

BMW Z4 (E86) (03/06-01/09)

BMW Z4 (E85) (09/02-12/09)

**Ball joint****316 010 4307****MBJ0192****Notes**Front Axle Left  
Front Axle Right  
outer

Height [mm]

54

Outer Diameter [mm]

41

Required quantity

2

Thread Size

M12x1,5

replacement in pairs recommended

**References**

BMW 1 126 254

BMW 1 127 726

BMW 31 12 1 127 725

BMW 1 127 725



BMW 31 12 1 126 254

BMW 31 12 1 127 726

**Application info**

BMW 3 (E30) (09/82-10/94)

BMW Z1 (06/88-06/91)

Ball joint		316 010 4345	MBJ0193
<b>Notes</b>  Front Axle Left Front Axle Right inner  Height [mm] 136 Outer Diameter [mm] 41 Required quantity 2 Thread Size M14x1,5 replacement in pairs recommended			
<b>References</b> BMW 31 12 6 758 513 BMW 6 758 513		BMW 31 12 6 758 514 BMW 6 758 514	
<b>Application info</b> BMW 3 (E36) (09/90-08/00)		BMW Z3 (E36/7, E36/8) (10/95-06/03)	
Ball joint		32-16 010 0002	MBJ0194
<b>Notes</b>  Front Axle Left Front Axle Right Lower  Outer Diameter [mm] 40 Required quantity 2 replacement in pairs recommended			
<b>References</b> Mitsubishi MR911569 Mitsubishi MR916133		Mitsubishi MR911570 Mitsubishi MR916134	
<b>Application info</b> Mitsubishi Carisma (07/95-06/06)		Mitsubishi Space Star (DG_) (06/98-12/04)	

**Ball joint****32-16 010 0025****MBJ0198****Notes**

Front Axle Left  
 Front Axle Right  
 Lower  
 with accessories

Outer Diameter [mm] 40  
 Required quantity 2  
 replacement in pairs recommended

**References**

Citroën 16 124 483 80  
 Citroën 3520.V0  
 Citroën 3521.R1  
 Mitsubishi 4013A009  
 Mitsubishi 4013A281  
 Peugeot 16 124 483 80  
 Peugeot 3520 V0  
 Peugeot 3521 R1

Citroën 16 124 484 80  
 Citroën 3520.X9  
 Citroën 3521.V0  
 Mitsubishi 4013A010  
 Mitsubishi 4013A282  
 Peugeot 16 124 484 80  
 Peugeot 3520.X9  
 Peugeot 3521.V0

**Application info**

Citroën C-Crosser (02/07--)  
 Mitsubishi ASX I (11/09--)  
 Mitsubishi Lancer VIII (03/07--)  
 Mitsubishi Outlander III (11/10--)  
 Peugeot 4008 (05/12--)

Citroën C4 AIRCROSS (08/10--)  
 Mitsubishi Lancer VII (03/00-12/13)  
 Mitsubishi Outlander II (11/06-12/12)  
 Peugeot 4007 (02/07-03/13)

**Ball joint****35-16 010 0001****MBJ0205****Notes**

Front Axle Left  
 Front Axle Right  
 Lower

Outer Diameter [mm] 43  
 Required quantity 2  
 replacement in pairs recommended





**References**

Ford 3 703 255

Ford USA 3 703 255

Kia 0G030-34550A

Mazda 0G030-34-550A

Mazda B25D-34-350B

Mazda C100-34-350A

Mazda C145-34-350A

Mazda G030-34-350F

Mazda GA2A-34-300

Mazda GA2A-34-350

Mazda GA2B-34 300

Mazda GA2B-34-350A

Mazda GA6A-34-300B

Mazda GA6A-34-300E

Mazda GA6B-34 050E

Mazda GA6B-34 300B

Mazda GA6B-34 300D

Mazda GA6B-34 350B

Mazda GA6B-34 350D

Mazda GA6B-34-350E

Mazda GA6B-99-356A

Mazda GA6B-E3-4350

Mazda GD7D-34-350A

Mazda GE4T-34 300B

Mazda GE4T-34 350B

Mazda GE4T-34-300

Mazda GE4T-34-300E

Mazda GE4T-34-350C

Mazda GF22-34-300A

Mazda GG2A-34 300C

Mazda GJ22-34-300A

Mazda GJ22-34-350A

Mazda GJ83-34 300A

Mazda GJ83-34-350B

Mazda GN98-34-350A

Mazda KA39-34-350A

Mazda M001-99-356A

Ford 3 707 090

Ford USA 3 707 090

Kia 0G030-34550B

Mazda B25D-34-300B

Mazda C100-34-300A

Mazda C145-34-300A

Mazda G030-34-300F

Mazda G030-99-356

Mazda GA2A-34-300A

Mazda GA2A-34-350A

Mazda GA2B-34-300A

Mazda GA6A-34-300A

Mazda GA6A-34-300D

Mazda GA6A-99-356

Mazda GA6B-34 300A

Mazda GA6B-34 300C

Mazda GA6B-34 350A

Mazda GA6B-34 350C

Mazda GA6B-34-300E

Mazda GA6B-99-356

Mazda GA6B-E3-4300

Mazda GD7A-34-300A

Mazda GE3T-34-350E

Mazda GE4T-34 300D

Mazda GE4T-34 350D

Mazda GE4T-34-300C

Mazda GE4T-34-350

Mazda GE4T-34-350E

Mazda GF22-34-350A

Mazda GG2A-34 350C

Mazda GJ22-34-300B

Mazda GJ22-34-350B

Mazda GJ83-34-300B

Mazda GN98-34-300A

Mazda KA39-34-300A

Mazda LC62-34-550

**Application info**

Ford Maverick II (02/01--)

Kia Clarus (05/96--)

Mazda 626 (GC) (11/82-01/90)

Mazda 626 (GE) (08/91-08/98)

Mazda 929 (HB, HC, HV) (12/81-08/91)

Mazda MX-6 (GE) (07/91-09/97)

Mazda Tribute I (EP) (03/00-05/08)

Ford USA Probe II (09/92-03/98)

Mazda 323 (BJ) (05/98-05/04)

Mazda 626 (GD, GV) (06/87-10/98)

Mazda 626 (GF, GW) (05/97-12/02)

Mazda MPV II (LW) (08/99-12/06)

Mazda Premacy (01/99-06/05)

**Ball joint**

35-16 010 0006

MBJ0206

**Notes**

Front Axle Left  
Front Axle Right  
Lower

Height [mm]

73.4

Outer Diameter [mm]

43

Required quantity

2

replacement in pairs recommended



**References**

Mazda B32H-34 300

Mazda B32H-34 350E

Mazda B32H-34-300B

Mazda B32H-34-300D

Mazda B32H-34-350A

Mazda B32H-34-350C

Mazda B37F-34-300A

Mazda B37F-34-350A

Mazda BP4K-34 300A

Mazda BP4K-34 350A

Mazda BP4K-34-300D

Mazda BP4K-34-350D

Mazda C513-34-300

Mazda CC30-34 300A

Mazda CC30-34 300C

Mazda CC30-34 300E

Mazda CC30-34 350B

Mazda CC30-34 350D

Mazda CD99-34-300A

Mazda B32H-34 350

Mazda B32H-34-300A

Mazda B32H-34-300C

Mazda B32H-34-300E

Mazda B32H-34-350B

Mazda B32H-34-350D

Mazda B37F-34-300B

Mazda B37F-34-350B

Mazda BP4K-34 300B

Mazda BP4K-34 350B

Mazda BP4K-34-350C

Mazda BP4K-34-350E

Mazda C513-34-350

Mazda CC30-34 300B

Mazda CC30-34 300D

Mazda CC30-34 350A

Mazda CC30-34 350C

Mazda CC30-34 350E

Mazda CD99-34-350A

**Application info**

Mazda 3 (BK) (09/99-12/09)

Mazda 5 (CR) (02/05-12/10)

Mazda 5 (CW) (06/10--)

**Ball joint**

35-16 010 0026

MBJ0211

**Notes**

Front Axle Left  
 Front Axle Right  
 Upper  
 Outer Diameter [mm] 39  
 Required quantity 2  
 Thread Size M12x1,25

replacement in pairs recommended



**References**

Mazda GJ6A-34 200B

Mazda GJ6A-34 250B

Mazda GP9A-34-200A

Mazda GP9A-34-200B

Mazda GP9A-34-250A

Mazda GP9A-34-250B

Mazda GV2W-34 200

Mazda GV2W-34 250

**Application info**

Mazda 6 (GG, GY) (01/02-12/08)

Mazda 6 (GH) (08/07-12/13)

**Ball joint**

35-16 010 0032

MBJ0483

**Notes**

Front Axle Left  
 Front Axle Right  
 Required quantity 2

replacement in pairs recommended



**References**

Mazda D10E-34-300	Mazda D10E-34-350
Mazda KD35-34-300D	Mazda KD35-34-300E
Mazda KD35-34-300F	Mazda KD35-34-300G
Mazda KD35-34-300H	Mazda KD35-34-300J
Mazda KD35-34-300L	Mazda KD35-34-300M
Mazda KD35-34-300N	Mazda KD35-34-300P
Mazda KD35-34-300R	Mazda KD35-34-300S
Mazda KD35-34-350D	Mazda KD35-34-350E
Mazda KD35-34-350F	Mazda KD35-34-350G
Mazda KD35-34-350H	Mazda KD35-34-350J
Mazda KD35-34-350L	Mazda KD35-34-350M
Mazda KD35-34-350N	Mazda KD35-34-350P
Mazda KD35-34-350R	Mazda KD35-34-350S

**Application info**

Mazda 6 (GJ) (08/12--)	Mazda CX-3 (DK) (01/15--)
Mazda CX-5 I (KE) (11/11-02/17)	

**Ball joint****36-16 010 0000****MBJ0213****Notes**

Front Axle Left  
 Front Axle Right  
 Lower  
 with accessories

Outer Diameter [mm] 41  
 Required quantity 2  
 replacement in pairs recommended

**References**

Nissan 40160-9W200	Nissan 54500-BB00A
Nissan 54500-BR30A	Nissan 54500-JD000
Nissan 54501-BB00A	Nissan 54501-BR30A
Nissan 54501-JD000	Nissan 54501-JG000
Nissan 54501-JG00B	Renault 54501JY00A
Renault 545040445R	Renault 545055212R

**Application info**

Nissan Murano (Z50) (04/02-12/09)	Nissan Qashqai I (J10_) (12/06-04/14)
Nissan Qashqai II (J11_) (11/13--)	Nissan X-Trail (T31) (03/07-12/18)
Renault Kadjar (06/15--)	Renault Koleos I (09/08--)

**Ball joint** **36-16 010 0001** **MBJ0214**

**Notes**

Front Axle Left  
 Front Axle Right  
 Upper  
 with accessories

Required quantity

2

Thread Size

M14x1,5

replacement in pairs recommended



**References**

Ford 1 954 430

Nissan 40110-01G00

Nissan 40110-01G25

Nissan 40110-01G26

Nissan 40110-0F000

Nissan 40110-B9500

Nissan 40110-T6000

Nissan 40110-T6025

Nissan 40110-V0100

**Application info**

Ford Maverick I (02/93-04/98)

Nissan Pick Up (D21) (09/85-12/08)

Nissan Terrano I (07/86-02/96)

Nissan Terrano II (10/92-09/07)

Nissan Urvan (E24) (06/86-05/97)

**Ball joint** **36-16 010 0006** **MBJ0216**

**Notes**

Front Axle Left  
 Front Axle Right  
 Lower  
 with accessories

Height [mm]

50

Outer Diameter [mm]

38

Required quantity

2

Thread Size

M14x1,5

replacement in pairs recommended



**References**

Nissan 40160-50A00  
 Nissan 40160-60Y60  
 Nissan 40160-70J00  
 Nissan 40160-J7500  
 Nissan 54500-50J10  
 Nissan 54500-69C00  
 Nissan 54500-90J00  
 Nissan 54501-50J00  
 Nissan 54501-50J25  
 Nissan 54501-90J00

Nissan 40160-50J25  
 Nissan 40160-69C00  
 Nissan 40160-86M00  
 Nissan 54500-50J00  
 Nissan 54500-50J25  
 Nissan 54500-86J00  
 Nissan 54500-90J10  
 Nissan 54501-50J10  
 Nissan 54501-86J00  
 Nissan 54501-90J10

**Application info**

Nissan Primera (P10, W10) (06/90-03/98)  
 Nissan Sunny (B12, N13) (01/86-10/91)

Nissan Primera (P11, WP11) (06/96-07/02)

**Ball joint****36-16 010 0023****MBJ0221****Notes**

Front Axle Left  
 Front Axle Right  
 Upper

Outer Diameter [mm] 42  
 Required quantity 2  
 Thread Size M14x1,5  
 replacement in pairs recommended

**References**

Nissan 40110EA000  
 Nissan 54525-EB30A

Nissan 54524-EB30A

**Application info**

Nissan Navara (D40) (10/04--)

Nissan Pathfinder (R51) (01/05--)

**Ball joint****36-16 010 0025****MBJ0222****Notes**

Front Axle Left  
 Front Axle Right  
 Lower

Outer Diameter [mm] 45.2  
 Required quantity 2  
 replacement in pairs recommended

**References**

Nissan 40160-EA00A  
 Nissan 54500-EB30C  
 Nissan 54500-EB31C  
 Nissan 54501-EB30C  
 Nissan 54501-EB31C

Nissan 54500-EB300  
 Nissan 54500-EB31A  
 Nissan 54501-EB300  
 Nissan 54501-EB31A

**Application info**

Nissan Navara (D40) (10/04--)

Nissan Pathfinder (R51) (01/05--)

**Ball joint****36-16 010 0034****MBJ0302****Notes**

Front Axle Left  
 Front Axle Right

Outer Diameter [mm] 38  
 Required quantity 2  
 replacement in pairs recommended

**References**

Nissan 54500-1FU0B  
 Nissan 54500-1KA0A  
 Nissan 54500-EL000  
 Nissan 54501-1FU0B  
 Nissan 54501-1KA0A  
 Nissan 54501-EL000

Nissan 54500-1JY0A  
 Nissan 54500-1KA0B  
 Nissan 54500-EW000  
 Nissan 54501-1JY0A  
 Nissan 54501-1KA0B  
 Nissan 54501-EW000

**Application info**

Nissan Cube (Z12) (09/07--)

Nissan Leaf I (ZE0) (11/10--)

Nissan Tiida (05/04-12/13)

Nissan Juke (F15) (06/10--)

Nissan NV200 (02/10--)

**Ball joint****36-16 010 0039****MBJ0223****Notes**

Front Axle Left  
 Front Axle Right  
 Lower  
 with accessories

Height [mm]

54

Outer Diameter [mm]

39

Required quantity

2

Thread Size

M14x1,5

replacement in pairs recommended

**References**

Mazda 1N00-99-356

Nissan 40160-0M020

Nissan 40160-50Y02

Nissan 40160-50Y10

Nissan 40160-52Y10

Nissan 40160-60Y00

Nissan 40160-60Y20

Nissan 40160-69Y10

Nissan 40160-Y02G0

Nissan 54500-0M010

Nissan 54500-0M060

Nissan 54500-52Y15

Nissan 54500-52Y70

Nissan 54501-0M010

Nissan 54501-52Y15

Nissan 54501-52Y70

Nissan 40160-0M010

Nissan 40160-50Y00

Nissan 40160-50Y0R

Nissan 40160-52Y00

Nissan 40160-52Y20

Nissan 40160-60Y10

Nissan 40160-69Y00

Nissan 40160-F4200

Nissan 40161-52Y10

Nissan 54500-0M020

Nissan 54500-52Y10

Nissan 54500-52Y60

Nissan 54500-69Y10

Nissan 54501-52Y10

Nissan 54501-52Y60

Nissan 54501-69Y10

**Application info**

Nissan 100 NX (03/90-01/96)

Nissan Sunny (B13, N14, Y10) (05/90-03/00)

Nissan Almera I/Pulsar I (07/95-01/01)



**Ball joint****36-16 010 0040****MBJ0224****Notes**

Front Axle Left  
 Front Axle Right  
 Lower  
 with accessories

Height [mm]

46

Outer Diameter [mm]

35

Required quantity

2

Thread Size

M12x1,25

replacement in pairs recommended

**References**

Nissan 40160-4F100

Nissan 54500-44B00

Nissan 54500-4F102

Nissan 54500-4F105

Nissan 54500-4F150

Nissan 54501-44B00

Nissan 54501-4F102

Nissan 54501-4F105

Nissan 54501-4F150

**Application info**

Nissan Micra (K11) (01/92-12/07)

**Ball joint****36-16 010 0043****MBJ0225****Notes**

Front Axle Left  
 Front Axle Right  
 Lower  
 with accessories

Outer Diameter [mm]

38

Required quantity

2

Thread Size

M14x1,5

replacement in pairs recommended

**References**

Nissan 54500-4M410

Nissan 54500-4M411

Nissan 54500-BM410

Nissan 54500-F4600

Nissan 54501-4M410

Nissan 54501-4M411

Nissan 54501-BM410

Nissan 54501-F4600

**Application info**

Nissan Almera II (01/00--)

**Ball joint****36-16 010 0044****MBJ0226****Notes**

Front Axle Left  
 Front Axle Right  
 Lower  
 with accessories

Outer Diameter [mm] 38  
 Required quantity 2  
 replacement in pairs recommended

**References**

Nissan 40160-AX000  
 Nissan 54501-AX60B  
 Nissan 54570-AX600

Nissan 54501-AX600  
 Nissan 54501-BC42A  
 Nissan 60401-35517

**Application info**

Nissan Micra (K12) (03/02--)

Nissan Note I (01/05-08/13)

**Ball joint****36-16 010 0045****MBJ0227****Notes**

Front Axle Left  
 Front Axle Right  
 Lower  
 with accessories

Required quantity 2  
 Thread Size M14x1,5  
 replacement in pairs recommended

**References**



Nissan 40160-2Y000  
 Nissan 54500-AV600  
 Nissan 54500-AV60A  
 Nissan 54501-AV605  
 Nissan 54501-AV60C

Nissan 54401-AV60A  
 Nissan 54500-AV605  
 Nissan 54501-AV600  
 Nissan 54501-AV60A

**Application info**

Nissan Almera Tino (12/98-02/06)  
 Nissan Primera (P12, WP12) (01/02--)

Nissan Maxima (A33) (04/99-11/03)

Ball joint		36-16 010 0049	MBJ0228
<b>Notes</b>  Front Axle Left Front Axle Right Lower with accessories  Outer Diameter [mm] 35 Required quantity 2 Thread Size M12x1,25 replacement in pairs recommended			
<b>References</b> Nissan 54500-2U711 Nissan 54500-6F600 Nissan 54501-2U711 Nissan 54501-6F600			
<b>Application info</b> Nissan Micra (K11) (01/92-12/07)			
Ball joint		36-16 010 0055	MBJ0321
<b>Notes</b>  Front Axle Left Front Axle Right  Outer Diameter [mm] 35 Required quantity 2 replacement in pairs recommended			
<b>References</b> Nissan 54500-1HA0C Nissan 54500-1HA5A Nissan 54500-1HA6A Nissan 54501-1HA0C Nissan 54501-1HA5A Nissan 54501-1HA6A			
<b>Application info</b> Nissan Micra (K13) (05/10--) Nissan Note II (09/12--)			

## Ball joint

37-16 010 0002

MBJ0231

## Notes

Front Axle Left  
 Front Axle Right  
 Lower  
 with accessories

Outer Diameter [mm]

40

Required quantity

2

Thread Size

M12x1,25

replacement in pairs recommended



## References

Hyundai 54503-22A00

Hyundai 54503-31600

Hyundai 54520-31600

Hyundai 54530-25000

Hyundai 54530-3X000

Kia 54503 25A00

Kia 54530 0U000

Kia 54530 2F000

Mitsubishi AW311699

Mitsubishi MB303374

Mitsubishi MB349463

Mitsubishi MB430406

Mitsubishi MB518043

Mitsubishi MB518205

Mitsubishi MB518960

Mitsubishi MB891789

Hyundai 54503-25A00

Hyundai 54503-38A00

Hyundai 54530-0U000

Hyundai 54530-31600

Kia 54503 22A00

Kia 54503 31600

Kia 54530 25000

Kia 54530 31600

Mitsubishi MB241883

Mitsubishi MB303375

Mitsubishi MB349464

Mitsubishi MB430407

Mitsubishi MB518044

Mitsubishi MB518206

Mitsubishi MB518961

Mitsubishi MB891790

**Application info**

Hyundai Accent I (05/94-12/02)  
 Hyundai Accent IV (08/10--)  
 Hyundai Coupé II (05/96-04/02)  
 Hyundai Creta I (01/16--)  
 Hyundai Elantra I (03/00-09/06)  
 Hyundai Getz (06/01-01/11)  
 Hyundai Matrix (06/01-08/10)  
 Hyundai Sonata II (09/88-12/93)  
 Hyundai XG (12/98-12/05)  
 Hyundai i20 II (11/14--)  
 Kia Cerato I (LD) (01/01--)  
 Kia Cerato III (YD) (09/12--)  
 Kia Venga (02/10--)  
 Mitsubishi Colt IV (03/92-04/96)  
 Mitsubishi Galant IV (11/87-03/93)  
 Mitsubishi Lancer IV (04/88-12/97)  
 Mitsubishi Sapporo III (06/87-08/90)

Hyundai Accent II (09/99-11/17)  
 Hyundai Accent V (01/18--)  
 Hyundai Coupé III (01/01-12/12)  
 Hyundai Creta II (SU2\_) (03/20--)  
 Hyundai Elantra V (09/10--)  
 Hyundai Lantra II (06/95-12/00)  
 Hyundai Solaris (01/17--)  
 Hyundai Veloster I (03/11-12/17)  
 Hyundai i20 I (08/08--)  
 Hyundai ix20 (11/10--)  
 Kia Cerato II (TD) (01/09--)  
 Kia Rio IV (01/17--)  
 Mitsubishi Colt III (10/86-05/92)  
 Mitsubishi Galant III (10/83-12/90)  
 Mitsubishi Lancer III (11/83-08/92)  
 Mitsubishi Lancer V (07/91-10/03)  
 Mitsubishi Sigma (10/90-10/96)

**Ball joint****37-16 010 0009****MBJ0235****Notes**

Front Axle Left  
 Front Axle Right  
 Lower  
 Required quantity  
 2  
 Thread Size  
 M14x1,5

Required quantity

Thread Size

replacement in pairs recommended

**References**

Hyundai 51760-38000  
 Hyundai 51761-38A00  
 Kia 51760 3F000

Hyundai 51760-38000AT  
 Kia 51760 38000  
 Kia 51761 38A00

**Application info**

Hyundai Sonata IV (03/98-12/05)  
 Kia Magentis I (05/01--)

Hyundai XG (12/98-12/05)  
 Kia Opirus (09/03--)

**Ball joint****37-16 010 0013****MBJ0237****Notes**

Front Axle Left  
 Front Axle Right  
 Lower

Required quantity

2

Thread Size

M16x1,5

replacement in pairs recommended

**References**

Hyundai 54530-47000  
 Hyundai 54530-4AA00

Hyundai 54530-4A000  
 Mitsubishi MR162699

**Application info**

Hyundai H-1 I (10/97-04/08)  
 MG MG 6 (11/10--)  
 Mitsubishi L400 (06/94-04/07)

Hyundai Starex (06/97--)  
 Mitsubishi L300 III (08/86-12/13)

**Ball joint****37-16 010 0019****MBJ0239****Notes**

Front Axle Left  
 Front Axle Right

Required quantity

2

Thread Size 1

M12x1,25

replacement in pairs recommended

**References**



Hyundai 51760-0Q000  
 Hyundai 51760-2H000  
 Kia 51760 2H000



Hyundai 51760-2G000  
 Kia 51760 2G000  
 Kia 51760-0Q000

**Application info**



Hyundai Elantra IV (09/05--)  
 Kia Cee'd I (12/06-02/13)  
 Kia Magentis II (10/05--)

Hyundai i30 I (10/07-06/12)  
 Kia Magentis I (05/01--)

Ball joint		37-16 010 0020	MBJ0240
<b>Notes</b>  Front Axle Left Front Axle Right Lower with accessories  Required quantity 2 Thread Size 1 M12x1,25 replacement in pairs recommended			
<b>References</b> Hyundai 51760-0P000 Hyundai 51760-1G001 Kia 51760 1G001		Hyundai 51760-1G000 Kia 51760 1G000	
<b>Application info</b> Hyundai Accent III (11/05-12/12)		Kia Rio II (03/05--)	
Ball joint		37-16 010 0022	MBJ0242
<b>Notes</b>  Front Axle Left Front Axle Right Upper  Required quantity 2 Thread Size M14x1,5 replacement in pairs recommended			
<b>References</b> Hyundai 54440-H1000			
<b>Application info</b> Hyundai Teracon (06/01-03/08)			

Ball joint		37-16 010 0027	MBJ0311
<p><b>Notes</b></p> <p>Front Axle Left Front Axle Right</p> <p>Required quantity replacement in pairs recommended</p> <p>2</p>			
<p><b>References</b></p> <p>Hyundai 54530-3S000</p>		<p>Kia 54530 3S000</p>	
<p><b>Application info</b></p> <p>Hyundai Tucson I (06/04--) Kia Sportage III (09/09--)</p>		<p>Hyundai ix35 (08/09--)</p>	
Ball joint		37-16 010 0029	MBJ0460
<p><b>Notes</b></p> <p>Front Axle Left Lower outer with accessories</p> <p>Paired article number Required quantity Thread Size replacement in pairs recommended</p> <p>37-16 010 0030   MBJ0461 1 M12x1,25</p>			
<p><b>References</b></p> <p>Hyundai 54530-F2000</p>			
<p><b>Application info</b></p> <p>Hyundai Elantra VI (09/15--)</p>		<p>Hyundai Kona I (06/17--)</p>	



Ball joint		37-16 010 0030	MBJ0461
<p><b>Notes</b></p> <p>Front Axle Right Lower outer with accessories</p> <p>Paired article number 37-16 010 0029   MBJ0460 Required quantity 1 Thread Size M12x1,25 replacement in pairs recommended</p>			
<p><b>References</b></p> <p>Hyundai 54530-F2100</p>			
<p><b>Application info</b></p> <p>Hyundai Elantra VI (09/15--)</p> <p style="text-align: right;">Hyundai Kona I (06/17--)</p>			
Ball joint		37-16 010 0032	MBJ0505
<p><b>Notes</b></p> <p>Front Axle Right</p> <p>Paired article number 37-16 010 0033   MBJ0506 Required quantity 1 replacement in pairs recommended</p>			
<p><b>References</b></p> <p>Hyundai 54530-G4BA0</p> <p style="text-align: right;">Kia 54530 G4BA0</p>			
<p><b>Application info</b></p> <p>Hyundai i30 III (11/16--)</p> <p style="text-align: right;">Kia Ceed IV (03/18--)</p>			

**Ball joint****37-16 010 0033****MBJ0506****Notes**

Front Axle Left  
 Paired article number 37-16 010 0032 | MBJ0505  
 Required quantity 1

replacement in pairs recommended

**References**

Hyundai 54530-G4AA0

Kia 54530 G4AA0

**Application info**

Hyundai i30 III (11/16--)

Kia Ceed IV (03/18--)

**Control arm****316 035 0005/HD****MCA0430HD****Notes**

Aluminium  
 Carbon Neutral  
 Control Arm  
 Front  
 Front Axle Left  
 with rubber mount

Article number of recommended accessories 314 654 0002  
 Length [mm] 400  
 Paired article number 316 035 0006/HD | MCA0431HD  
 Replace in pairs only  
 Required quantity 1  
 Thread Size M14x1,5  
 reinforced version



**References**

BMW 2 405 861	BMW 2 409 599
BMW 31 12 2 405 861	BMW 31 12 2 409 599
BMW 31 12 4 036 269	BMW 31 12 6 763 703
BMW 31 12 6 763 707	BMW 31 12 6 769 797
BMW 31 12 6 769 801	BMW 4 036 269
BMW 6 763 703	BMW 6 763 707
BMW 6 769 797	BMW 6 769 801
BMW (Brilliance) 2 405 861	BMW (Brilliance) 2 409 599
BMW (Brilliance) 31 12 2 405 861	BMW (Brilliance) 31 12 2 409 599
BMW (Brilliance) 31 12 4 036 269	BMW (Brilliance) 31 12 6 763 703
BMW (Brilliance) 31 12 6 763 707	BMW (Brilliance) 31 12 6 769 797
BMW (Brilliance) 31 12 6 769 801	BMW (Brilliance) 4 036 269
BMW (Brilliance) 6 763 703	BMW (Brilliance) 6 763 707
BMW (Brilliance) 6 769 797	BMW (Brilliance) 6 769 801

**Application info**

BMW 1 (E81, E82, E87, E88) (02/03-12/13)	BMW 3 (E90, E91, E92, E93) (02/04-12/13)
BMW X1 (E84) (03/09-06/15)	BMW Z4 (E89) (02/09-08/16)

**Control arm**

316 035 0006/HD

MCA0431HD

**Notes**

Aluminium  
Carbon Neutral  
Control Arm  
Front  
Front Axle Right  
with rubber mount

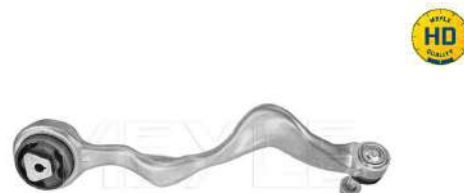

Article number of recommended accessories	314 654 0002
Length [mm]	400
Paired article number	316 035 0005/HD   MCA0430HD
Replace in pairs only	
Required quantity	1
Thread Size	M14x1,5
reinforced version	

**References**

- |                                  |                                  |
|----------------------------------|----------------------------------|
| BMW 2 405 862                    | BMW 2 409 598                    |
| BMW 31 12 2 405 862              | BMW 31 12 2 409 598              |
| BMW 31 12 4 036 270              | BMW 31 12 6 763 704              |
| BMW 31 12 6 763 708              | BMW 31 12 6 769 798              |
| BMW 31 12 6 769 802              | BMW 4 036 270                    |
| BMW 6 763 704                    | BMW 6 763 708                    |
| BMW 6 769 798                    | BMW 6 769 802                    |
| BMW (Brilliance) 2 405 862       | BMW (Brilliance) 2 409 598       |
| BMW (Brilliance) 31 12 2 405 862 | BMW (Brilliance) 31 12 2 409 598 |
| BMW (Brilliance) 31 12 4 036 270 | BMW (Brilliance) 31 12 6 763 704 |
| BMW (Brilliance) 31 12 6 763 708 | BMW (Brilliance) 31 12 6 769 798 |
| BMW (Brilliance) 31 12 6 769 802 | BMW (Brilliance) 4 036 270       |
| BMW (Brilliance) 6 763 704       | BMW (Brilliance) 6 763 708       |
| BMW (Brilliance) 6 769 798       | BMW (Brilliance) 6 769 802       |

**Application info**

- |  |  |
|--|--|
| BMW 1 (E81, E82, E87, E88) (02/03-12/13) | BMW 3 (E90, E91, E92, E93) (02/04-12/13) |
| BMW X1 (E84) (03/09-06/15)               | BMW Z4 (E89) (02/09-08/16)               |

**Control arm**

316 035 0007

MCA0432

**Notes**

Control Arm  
 Rear  
 Rear Axle Right  
 Sheet Steel  
 Upper  
 with ball joint  
 with rubber mount  
 Length [mm] 306  
 Paired article number 316 035 0008 | MCA0433  
 Required quantity 1  
 Thread Size M14x1,5  
 replacement in pairs recommended







**References**

- |                     |                     |
|---------------------|---------------------|
| BMW 1 095 412       | BMW 33 32 1 095 412 |
| BMW 33 32 6 768 274 | BMW 33 32 6 770 748 |
| BMW 33 32 6 770 860 | BMW 6 768 274       |
| BMW 6 770 748       | BMW 6 770 860       |

**Application info**

- BMW X5 (E53) (01/00-12/06)

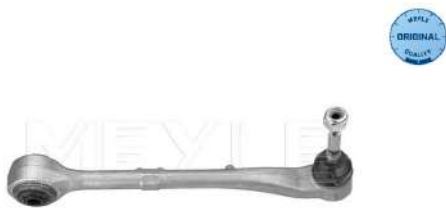
Control arm		316 035 0008	MCA0433
<b>Notes</b>  Control Arm Rear Rear Axle Left Sheet Steel Upper with ball joint with rubber mount  Length [mm] 306 Paired article number 316 035 0007   MCA0432 Required quantity 1 Thread Size M14x1,5 replacement in pairs recommended			
<b>References</b> BMW 1 095 411 BMW 33 32 1 095 411 BMW 33 32 6 768 273 BMW 33 32 6 770 747 BMW 33 32 6 770 859 BMW 6 768 273 BMW 6 770 747 BMW 6 770 859			
<b>Application info</b> BMW X5 (E53) (01/00-12/06)			
Control arm		316 050 0001	MCA0434
<b>Notes</b>  Aluminium Control Arm Front Front Axle Left with rubber mount  Length [mm] 330 Paired article number 316 050 0002   MCA0435 Required quantity 1 Thread Size M14x1,5 replacement in pairs recommended			
<b>References</b> BMW 1 141 961 BMW 31 12 1 141 961			
<b>Application info</b> BMW 5 (E39) (09/95-06/04)			

Control arm		316 050 0002	MCA0435
<b>Notes</b>  Aluminium Control Arm Front Front Axle Right with rubber mount  Length [mm] 330 Paired article number 316 050 0001   MCA0434 Required quantity 1 Thread Size M14x1,5 replacement in pairs recommended			
<b>References</b> BMW 1 141 962 BMW 31 12 1 141 962			
<b>Application info</b> BMW 5 (E39) (09/95-06/04)			
Control arm		316 050 0003/HD	MCA0436HD
<b>Notes</b>  Aluminium Carbon Neutral Control Arm Front Axle Left with ball joint  Article number of recommended accessori 314 654 0004 Paired article number 316 050 0004/HD   MCA0437HD Replace in pairs only Required quantity 1 Thread Size 1 M12x1,5 Thread Size 2 M14x1,5 reinforced version			

**References**

BMW 1 094 465	BMW 1 096 985
BMW 1 752 717	BMW 2 157 594
BMW 2 158 880	BMW 2 158 894
BMW 2 282 121	BMW 2 341 297
BMW 2 343 353	BMW 31 12 1 094 465
BMW 31 12 1 096 985	BMW 31 12 1 752 717
BMW 31 12 2 157 594	BMW 31 12 2 158 880
BMW 31 12 2 158 894	BMW 31 12 2 282 121
BMW 31 12 2 341 297	BMW 31 12 2 343 353
BMW 31 12 6 750 223	BMW 31 12 6 751 317
BMW 31 12 6 752 717	BMW 31 12 6 758 220
BMW 31 12 6 758 519	BMW 31 12 6 770 247
BMW 31 12 6 774 819	BMW 31 12 6 777 851
BMW 6 750 223	BMW 6 751 317
BMW 6 752 717	BMW 6 758 220
BMW 6 758 519	BMW 6 770 247
BMW 6 774 819	BMW 6 777 851
BMW (Brilliance) 1 094 465	BMW (Brilliance) 1 096 985
BMW (Brilliance) 1 752 717	BMW (Brilliance) 2 282 121
BMW (Brilliance) 2 341 297	BMW (Brilliance) 2 343 353
BMW (Brilliance) 31 12 1 094 465	BMW (Brilliance) 31 12 1 096 985
BMW (Brilliance) 31 12 1 752 717	BMW (Brilliance) 31 12 2 282 121
BMW (Brilliance) 31 12 2 341 297	BMW (Brilliance) 31 12 2 343 353
BMW (Brilliance) 31 12 6 750 223	BMW (Brilliance) 31 12 6 751 317
BMW (Brilliance) 31 12 6 752 717	BMW (Brilliance) 31 12 6 758 519
BMW (Brilliance) 31 12 6 770 247	BMW (Brilliance) 31 12 6 774 819
BMW (Brilliance) 31 12 6 777 851	BMW (Brilliance) 6 750 223
BMW (Brilliance) 6 751 317	BMW (Brilliance) 6 752 717
BMW (Brilliance) 6 758 519	BMW (Brilliance) 6 770 247
BMW (Brilliance) 6 774 819	BMW (Brilliance) 6 777 851

**Application info**

BMW 3 (E46) (12/97-12/07)	BMW Z4 (E85) (09/02-12/09)
BMW Z4 (E86) (03/06-01/09)	

**Control arm**

316 050 0004/HD

MCA0437HD

**Notes**

Aluminium  
Carbon Neutral  
Control Arm  
Front Axle Right  
with ball joint

Article number of recommended accessory: 314 654 0004  
Paired article number: 316 050 0003/HD | MCA0436HD  
Replace in pairs only  
Required quantity: 1  
Thread Size 1: M12x1,5  
Thread Size 2: M14x1,5  
reinforced version



**References**

- |                                  |                                  |
|----------------------------------|----------------------------------|
| BMW 1 094 466                    | BMW 1 096 986                    |
| BMW 2 157 594                    | BMW 2 158 880                    |
| BMW 2 158 894                    | BMW 2 282 122                    |
| BMW 2 341 828                    | BMW 2 343 352                    |
| BMW 31 12 1 094 466              | BMW 31 12 1 096 986              |
| BMW 31 12 2 157 594              | BMW 31 12 2 158 880              |
| BMW 31 12 2 158 894              | BMW 31 12 2 282 122              |
| BMW 31 12 2 341 828              | BMW 31 12 2 343 352              |
| BMW 31 12 6 750 224              | BMW 31 12 6 751 318              |
| BMW 31 12 6 752 718              | BMW 31 12 6 758 520              |
| BMW 31 12 6 770 248              | BMW 31 12 6 774 820              |
| BMW 31 12 6 777 852              | BMW 6 750 224                    |
| BMW 6 751 318                    | BMW 6 752 718                    |
| BMW 6 758 520                    | BMW 6 770 248                    |
| BMW 6 774 820                    | BMW 6 777 852                    |
| BMW (Brilliance) 1 094 466       | BMW (Brilliance) 1 096 986       |
| BMW (Brilliance) 2 282 122       | BMW (Brilliance) 2 341 828       |
| BMW (Brilliance) 2 343 352       | BMW (Brilliance) 31 12 1 094 466 |
| BMW (Brilliance) 31 12 1 096 986 | BMW (Brilliance) 31 12 2 282 122 |
| BMW (Brilliance) 31 12 2 341 828 | BMW (Brilliance) 31 12 2 343 352 |
| BMW (Brilliance) 31 12 6 750 224 | BMW (Brilliance) 31 12 6 751 318 |
| BMW (Brilliance) 31 12 6 752 718 | BMW (Brilliance) 31 12 6 758 520 |
| BMW (Brilliance) 31 12 6 770 248 | BMW (Brilliance) 31 12 6 774 820 |
| BMW (Brilliance) 31 12 6 777 852 | BMW (Brilliance) 6 750 224       |
| BMW (Brilliance) 6 751 318       | BMW (Brilliance) 6 752 718       |
| BMW (Brilliance) 6 758 520       | BMW (Brilliance) 6 770 248       |
| BMW (Brilliance) 6 774 820       | BMW (Brilliance) 6 777 852       |



**Application info**

BMW 3 (E46) (12/97-12/07)  
 BMW Z4 (E86) (03/06-01/09)

BMW Z4 (E85) (09/02-12/09)

**Control arm**

316 050 0007/HD

MCA0440HD

**Notes**

Carbon Neutral  
 Control Arm  
 Front  
 Front Axle Left  
 Steel  
 with rubber mount

Article number of recommended accessories: 314 654 0010  
 Length [mm]: 600  
 Paired article number: 316 050 0008/HD | MCA0441HD  
 Replace in pairs only  
 Required quantity: 1  
 reinforced version



**References**

BMW 1 096 169  
 BMW 31 12 6 769 717

BMW 31 12 1 096 169  
 BMW 6 769 717

**Application info**

BMW X5 (E53) (01/00-12/06)

**Control arm**

316 050 0008/HD

MCA0441HD

**Notes**

Carbon Neutral  
 Control Arm  
 Front  
 Front Axle Right  
 Steel  
 with rubber mount

Article number of recommended accessories: 314 654 0010  
 Length [mm]: 600  
 Paired article number: 316 050 0007/HD | MCA0440HD  
 Replace in pairs only  
 Required quantity: 1  
 reinforced version



**References**

BMW 1 096 170

BMW 31 12 6 769 718

BMW 31 12 1 096 170

BMW 6 769 718

**Application info**

BMW X5 (E53) (01/00-12/06)

**Control arm**

316 050 0009

MCA0442

**Notes**

Control Arm  
Front Axle Left  
Rear  
Steel  
with rubber mount

Length [mm]

300

Paired article number

316 050 0010 | MCA0443

Required quantity

1

Thread Size

M14x1,5

replacement in pairs recommended



**References**

BMW 1 096 315

BMW 31 12 6 760 275

BMW 31 12 1 096 315

BMW 6 760 275

**Application info**

BMW X5 (E53) (01/00-12/06)

**Control arm**

316 050 0010

MCA0443

**Notes**

Control Arm  
Front Axle Right  
Rear  
Steel  
with rubber mount

Length [mm]

300

Paired article number

316 050 0009 | MCA0442

Required quantity

1

Thread Size

M14x1,5

replacement in pairs recommended

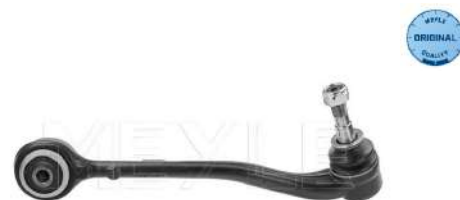

**References**

BMW 1 096 316

BMW 31 12 6 760 276

BMW 31 12 1 096 316

BMW 6 760 276

**Application info**

BMW X5 (E53) (01/00-12/06)

**Control arm**

316 050 0011/HD

MCA0444HD

**Notes**

Aluminium  
Carbon Neutral  
Control Arm  
Front  
Front Axle Left  
with rubber mount

Article number of recommended accessories 314 654 0011  
Length [mm] 424  
Paired article number 316 050 0012/HD | MCA0445HD  
Replace in pairs only  
Required quantity 1  
Thread Size M14x1,5  
reinforced version

**References**

BMW 31 12 4 026 453  
BMW 31 12 6 756 101  
BMW 31 12 6 765 993  
BMW 4 026 453  
BMW 6 756 101  
BMW 6 765 993

BMW 31 12 4 046 441  
BMW 31 12 6 760 519  
BMW 31 12 6 774 831  
BMW 4 046 441  
BMW 6 760 519  
BMW 6 774 831

**Application info**

BMW 7 (E65, E66) (07/01-12/09)

**Control arm** **316 050 0012/HD** **MCA0445HD**

**Notes**

Aluminium  
Carbon Neutral  
Control Arm  
Front  
Front Axle Right  
with rubber mount

Article number of recommended accessories: 316 654 0011  
Length [mm]: 424  
Paired article number: 316 050 0011/HD | MCA0444HD  
Replace in pairs only  
Required quantity: 1  
Thread Size: M14x1,5  
reinforced version

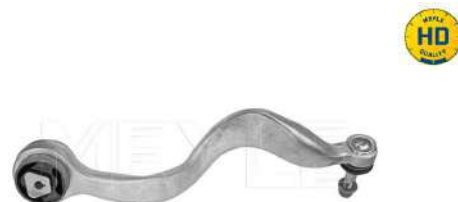

**References**

- |                     |                     |
|---------------------|---------------------|
| BMW 31 12 4 026 454 | BMW 31 12 4 046 442 |
| BMW 31 12 6 756 102 | BMW 31 12 6 760 520 |
| BMW 31 12 6 765 994 | BMW 31 12 6 774 832 |
| BMW 4 026 454       | BMW 4 046 442       |
| BMW 6 756 102       | BMW 6 760 520       |
| BMW 6 765 994       | BMW 6 774 832       |

**Application info**

BMW 7 (E65, E66) (07/01-12/09)

**Control arm** **316 050 0013** **MCA0446**

**Notes**

Aluminium  
Control Arm  
Front Axle Left  
Rear  
with rubber mount

Length [mm]: 300  
Paired article number: 316 050 0014 | MCA0447  
Required quantity: 1  
Thread Size: M14x1,5  
replacement in pairs recommended



**References**

BMW 2 347 983	BMW 2 347 985
BMW 31 12 2 347 983	BMW 31 12 2 347 985
BMW 31 12 6 755 835	BMW 31 12 6 770 121
BMW 31 12 6 770 771	BMW 31 12 6 770 837
BMW 31 12 6 777 937	BMW 31 12 6 777 939
BMW 6 755 835	BMW 6 770 121
BMW 6 770 771	BMW 6 770 837
BMW 6 777 937	BMW 6 777 939

**Application info**

BMW 6 (E63, E64) (09/03-12/10)	BMW 7 (E65, E66) (07/01-12/09)
--------------------------------	--------------------------------

**Control arm**

**316 050 0014 MCA0447**

**Notes**

Aluminium  
Control Arm  
Front Axle Right  
Rear  
with rubber mount  
Length [mm] 300  
Paired article number 316 050 0013 | MCA0446  
Required quantity 1  
Thread Size M14x1,5



replacement in pairs recommended

**References**

BMW 2 347 984	BMW 2 347 986
BMW 31 12 2 347 984	BMW 31 12 2 347 986
BMW 31 12 6 755 836	BMW 31 12 6 770 122
BMW 31 12 6 770 772	BMW 31 12 6 770 838
BMW 31 12 6 777 938	BMW 31 12 6 777 940
BMW 6 755 836	BMW 6 770 122
BMW 6 770 772	BMW 6 770 838
BMW 6 777 938	BMW 6 777 940

**Application info**

BMW 6 (E63, E64) (09/03-12/10)	BMW 7 (E65, E66) (07/01-12/09)
--------------------------------	--------------------------------

## Control arm

316 050 0015/HD

MCA0448HD

## Notes

Carbon Neutral  
Control Arm  
Front Axle Left  
Rear  
Steel  
with rubber mount

Article number of recommended accessories 314 654 0018  
Length [mm] 278  
Paired article number 316 050 0016/HD | MCA0449HD  
Replace in pairs only  
Required quantity 1  
Thread Size M14x1,5  
reinforced version



## References

BMW 0 360 275	BMW 2 229 521
BMW 3 412 135	BMW 3 415 027
BMW 3 418 337	BMW 3 426 433
BMW 3 451 881	BMW 31 10 3 412 135
BMW 31 10 3 415 027	BMW 31 10 3 418 337
BMW 31 10 3 426 433	BMW 31 10 3 451 881
BMW 31 12 0 360 275	BMW 31 12 2 229 521

## Application info

BMW X3 (E83) (01/03-12/11)

## Control arm

316 050 0016/HD

MCA0449HD

## Notes

Carbon Neutral  
Control Arm  
Front Axle Right  
Rear  
Steel  
with rubber mount

Article number of recommended accessories 314 654 0018  
Length [mm] 278  
Paired article number 316 050 0015/HD | MCA0448HD  
Replace in pairs only  
Required quantity 1  
Thread Size M14x1,5  
reinforced version



**References**

- |                     |                     |
|---------------------|---------------------|
| BMW 2 229 522       | BMW 3 412 136       |
| BMW 3 415 028       | BMW 3 418 338       |
| BMW 3 426 434       | BMW 3 451 882       |
| BMW 31 10 3 412 136 | BMW 31 10 3 415 028 |
| BMW 31 10 3 418 338 | BMW 31 10 3 426 434 |
| BMW 31 10 3 451 882 | BMW 31 12 2 229 522 |

**Application info**

BMW X3 (E83) (01/03-12/11)

**Control arm**

316 050 0017

MCA0450

**Notes**

Aluminium  
Control Arm  
Front Axle Left  
Rear  
with rubber mount  
Length [mm] 298  
Paired article number 316 050 0018 | MCA0451  
Required quantity 1  
Thread Size M14x1,5  
replacement in pairs recommended



**References**

- |                                  |                                  |
|----------------------------------|----------------------------------|
| BMW 2 347 951                    | BMW 2 347 963                    |
| BMW 31 12 2 347 951              | BMW 31 12 2 347 963              |
| BMW 31 12 4 028 607              | BMW 31 12 6 760 181              |
| BMW 31 12 6 768 297              | BMW 4 028 607                    |
| BMW 6 760 181                    | BMW 6 768 297                    |
| BMW (Brilliance) 31 12 6 760 181 | BMW (Brilliance) 31 12 6 768 297 |
| BMW (Brilliance) 6 760 181       | BMW (Brilliance) 6 768 297       |

**Application info**

BMW 5 (E60, E61) (12/01-12/10)

**Control arm** **316 050 0018** **MCA0451**

**Notes**

Aluminium  
Control Arm  
Front Axle Right  
Rear  
with rubber mount

Length [mm] 298  
Paired article number 316 050 0017 | MCA0450  
Required quantity 1  
Thread Size M14x1,5  
replacement in pairs recommended



**References**

- |                                  |                                  |
|----------------------------------|----------------------------------|
| BMW 2 347 952                    | BMW 2 347 965                    |
| BMW 31 12 2 347 952              | BMW 31 12 2 347 965              |
| BMW 31 12 4 028 608              | BMW 31 12 6 760 182              |
| BMW 31 12 6 768 298              | BMW 4 028 608                    |
| BMW 6 760 182                    | BMW 6 768 298                    |
| BMW (Brilliance) 31 12 6 760 182 | BMW (Brilliance) 31 12 6 768 298 |
| BMW (Brilliance) 6 760 182       | BMW (Brilliance) 6 768 298       |

**Application info**

BMW 5 (E60, E61) (12/01-12/10)

**Control arm** **316 050 0019/HD** **MCA0452HD**

**Notes**

Aluminium  
Carbon Neutral  
Control Arm  
Front  
Front Axle Left  
with rubber mount

Article number of recommended accessories 314 654 0005  
Length [mm] 421  
Paired article number 316 050 0020/HD | MCA0453HD  
Replace in pairs only  
Required quantity 1  
Thread Size M14x1,5  
reinforced version





**References**

- |                                  |                                  |
|----------------------------------|----------------------------------|
| BMW 2 348 047                    | BMW 31 10 2 348 047              |
| BMW 31 10 4 026 719              | BMW 31 12 4 046 437              |
| BMW 31 12 6 760 183              | BMW 31 12 6 765 995              |
| BMW 31 12 6 774 825              | BMW 4 026 719                    |
| BMW 4 046 437                    | BMW 6 760 183                    |
| BMW 6 765 995                    | BMW 6 774 825                    |
| BMW (Brilliance) 2 348 047       | BMW (Brilliance) 31 10 2 348 047 |
| BMW (Brilliance) 31 10 4 026 719 | BMW (Brilliance) 31 12 4 046 437 |
| BMW (Brilliance) 31 12 6 760 183 | BMW (Brilliance) 31 12 6 765 995 |
| BMW (Brilliance) 31 12 6 774 825 | BMW (Brilliance) 4 026 719       |
| BMW (Brilliance) 4 046 437       | BMW (Brilliance) 6 760 183       |
| BMW (Brilliance) 6 765 995       | BMW (Brilliance) 6 774 825       |

**Application info**

BMW 5 (E60, E61) (12/01-12/10)

**Control arm**

316 050 0020/HD

MCA0453HD

**Notes**

Aluminium  
Carbon Neutral  
Control Arm  
Front  
Front Axle Right  
with rubber mount

Article number of recommended accessories 316 654 0005  
Length [mm] 421  
Paired article number 316 050 0019/HD | MCA0452HD  
Replace in pairs only  
Required quantity 1  
Thread Size M14x1,5  
reinforced version

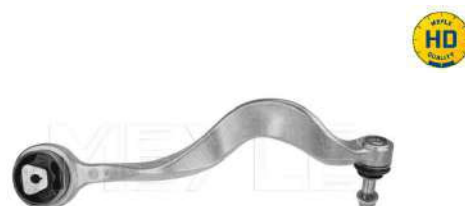

**References**

- |                                  |                                  |
|----------------------------------|----------------------------------|
| BMW 2 348 046                    | BMW 31 10 2 348 046              |
| BMW 31 10 4 026 720              | BMW 31 12 4 046 438              |
| BMW 31 12 6 760 184              | BMW 31 12 6 765 996              |
| BMW 31 12 6 774 826              | BMW 4 026 720                    |
| BMW 4 046 438                    | BMW 6 760 184                    |
| BMW 6 765 996                    | BMW 6 774 826                    |
| BMW (Brilliance) 2 348 046       | BMW (Brilliance) 31 10 2 348 046 |
| BMW (Brilliance) 31 10 4 026 720 | BMW (Brilliance) 31 12 4 046 438 |
| BMW (Brilliance) 31 12 6 760 184 | BMW (Brilliance) 31 12 6 765 996 |
| BMW (Brilliance) 31 12 6 774 826 | BMW (Brilliance) 4 026 720       |
| BMW (Brilliance) 4 046 438       | BMW (Brilliance) 6 760 184       |
| BMW (Brilliance) 6 765 996       | BMW (Brilliance) 6 774 826       |

**Application info**

BMW 5 (E60, E61) (12/01-12/10)

**Control arm**

**316 050 0021**

**MCA0454**

**Notes**

Aluminium  
Control Arm  
Front Axle Right  
Rear  
with rubber mount

Length [mm] 284  
Paired article number 316 050 0022 | MCA0455  
Required quantity 1  
Thread Size M14x1,5  
replacement in pairs recommended

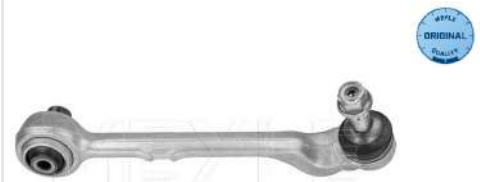



**References**

- |                                  |                                  |
|----------------------------------|----------------------------------|
| BMW 2 405 860                    | BMW 31 12 2 405 860              |
| BMW 31 12 6 763 700              | BMW 31 12 6 770 850              |
| BMW 31 12 6 786 204              | BMW 6 763 700                    |
| BMW 6 770 850                    | BMW 6 786 204                    |
| BMW (Brilliance) 31 12 6 763 700 | BMW (Brilliance) 31 12 6 770 850 |
| BMW (Brilliance) 6 763 700       | BMW (Brilliance) 6 770 850       |

**Application info**

BMW 1 (E81, E82, E87, E88) (02/03-12/13)	BMW 3 (E90, E91, E92, E93) (02/04-12/13)
BMW X1 (E84) (03/09-06/15)	BMW Z4 (E89) (02/09-08/16)

Control arm		316 050 0022	MCA0455												
<p><b>Notes</b></p> <p>Aluminium Control Arm Front Axle Left Rear with rubber mount</p> <p>Length [mm] 284</p> <p>Paired article number 316 050 0021   MCA0454</p> <p>Required quantity 1</p> <p>Thread Size M14x1,5</p> <p>replacement in pairs recommended</p>															
<p><b>References</b></p> <table border="0"> <tr> <td>BMW 2 405 859</td> <td>BMW 31 12 2 405 859</td> </tr> <tr> <td>BMW 31 12 6 763 699</td> <td>BMW 31 12 6 770 849</td> </tr> <tr> <td>BMW 31 12 6 786 203</td> <td>BMW 6 763 699</td> </tr> <tr> <td>BMW 6 770 849</td> <td>BMW 6 786 203</td> </tr> <tr> <td>BMW (Brilliance) 31 12 6 763 699</td> <td>BMW (Brilliance) 31 12 6 770 849</td> </tr> <tr> <td>BMW (Brilliance) 6 763 699</td> <td>BMW (Brilliance) 6 770 849</td> </tr> </table>				BMW 2 405 859	BMW 31 12 2 405 859	BMW 31 12 6 763 699	BMW 31 12 6 770 849	BMW 31 12 6 786 203	BMW 6 763 699	BMW 6 770 849	BMW 6 786 203	BMW (Brilliance) 31 12 6 763 699	BMW (Brilliance) 31 12 6 770 849	BMW (Brilliance) 6 763 699	BMW (Brilliance) 6 770 849
BMW 2 405 859	BMW 31 12 2 405 859														
BMW 31 12 6 763 699	BMW 31 12 6 770 849														
BMW 31 12 6 786 203	BMW 6 763 699														
BMW 6 770 849	BMW 6 786 203														
BMW (Brilliance) 31 12 6 763 699	BMW (Brilliance) 31 12 6 770 849														
BMW (Brilliance) 6 763 699	BMW (Brilliance) 6 770 849														
<p><b>Application info</b></p> <table border="0"> <tr> <td>BMW 1 (E81, E82, E87, E88) (02/03-12/13)</td> <td>BMW 3 (E90, E91, E92, E93) (02/04-12/13)</td> </tr> <tr> <td>BMW X1 (E84) (03/09-06/15)</td> <td>BMW Z4 (E89) (02/09-08/16)</td> </tr> </table>				BMW 1 (E81, E82, E87, E88) (02/03-12/13)	BMW 3 (E90, E91, E92, E93) (02/04-12/13)	BMW X1 (E84) (03/09-06/15)	BMW Z4 (E89) (02/09-08/16)								
BMW 1 (E81, E82, E87, E88) (02/03-12/13)	BMW 3 (E90, E91, E92, E93) (02/04-12/13)														
BMW X1 (E84) (03/09-06/15)	BMW Z4 (E89) (02/09-08/16)														
Control arm		316 050 0027/HD	MCA0456HD												
<p><b>Notes</b></p> <p>Carbon Neutral Control Arm Front Front Axle Left Steel with rubber mount</p> <p>Article number of recommended accessories 314 654 0012</p> <p>Length [mm] 444</p> <p>Paired article number 316 050 0028/HD   MCA0457HD</p> <p>Replace in pairs only</p> <p>Required quantity 1</p> <p>reinforced version</p>															

**References**

BMW 0 363 477

BMW 3 443 127

BMW 31 10 2 229 523

BMW 2 229 523

BMW 31 10 0 363 477

BMW 31 10 3 443 127

**Application info**

BMW X3 (E83) (01/03-12/11)

**Control arm**

316 050 0028/HD

MCA0457HD

**Notes**

Carbon Neutral  
Control Arm  
Front  
Front Axle Right  
Steel  
with rubber mount

Article number of recommended accessories 314 654 0012  
Length [mm] 444  
Paired article number 316 050 0027/HD | MCA0456HD  
Replace in pairs only  
Required quantity 1  
reinforced version



**References**

BMW 0 363 478

BMW 3 412 138

BMW 31 10 0 363 478

BMW 31 10 3 412 138

BMW 2 229 523



BMW 3 443 128

BMW 31 10 2 229 523

BMW 31 10 3 443 128

**Application info**

BMW X3 (E83) (01/03-12/11)

Control arm		316 050 0029/HD	MCA0458HD
<b>Notes</b>  Aluminium Carbon Neutral Control Arm Front Axle Left Rear with rubber mount  Article number of recommended accessories 314 654 0013 Length [mm] 450 Paired article number 316 050 0030/HD   MCA0459HD Replace in pairs only Required quantity 1 Thread Size M14x1,5 reinforced version			
<b>References</b> BMW 1 092 609 BMW 1 092 819 BMW 31 12 1 092 609 BMW 31 12 1 092 819			
<b>Application info</b> BMW 5 (E39) (09/95-06/04)			
Control arm		316 050 0030/HD	MCA0459HD
<b>Notes</b>  Aluminium Carbon Neutral Control Arm Front Axle Right Rear with rubber mount  Article number of recommended accessories 314 654 0013 Length [mm] 450 Paired article number 316 050 0029/HD   MCA0458HD Replace in pairs only Required quantity 1 Thread Size M14x1,5 reinforced version			
<b>References</b> BMW 1 092 610 BMW 1 092 820 BMW 31 12 1 092 610 BMW 31 12 1 092 820			

**Application info**

BMW 5 (E39) (09/95-06/04)

**Control arm**

316 050 0033/HD

MCA0460HD

**Notes**

Aluminium  
Carbon Neutral  
Control Arm  
Front Axle Right  
Upper  
can be adjusted three times  
with ball joint  
with fastening material  
with rubber mount



Camber correction [min.]

-30

Camber correction [min.]

30

Paired article number

316 050 0034/HD | MCA0461HD

Replace in pairs only

Required quantity

1

reinforced version

**References**

BMW 31 12 6 776 418

BMW 31 12 6 776 996

BMW 31 12 6 776 998

BMW 31 12 6 863 334

BMW 31 12 6 863 336

BMW 31 12 6 863 786

BMW 6 776 418

BMW 6 776 996

BMW 6 776 998

BMW 6 863 334

BMW 6 863 336

BMW 6 863 786

**Application info**

BMW X5 (E70) (02/06-07/13)

BMW X5 (F15) (08/13-07/18)

BMW X6 (E71) (06/07-07/14)

BMW X6 (F16) (08/14-07/19)

**Control arm**

316 050 0034/HD

MCA0461HD

**Notes**

Aluminium  
Carbon Neutral  
Control Arm  
Front Axle Left  
Upper  
can be adjusted three times  
with ball joint  
with fastening material  
with rubber mount



Camber correction [min.] -30  
Camber correction [min.] 30  
Paired article number 316 050 0033/HD | MCA0460HD  
Replace in pairs only  
Required quantity 1  
reinforced version

**References**

BMW 31 12 6 776 417	BMW 31 12 6 776 995
BMW 31 12 6 776 997	BMW 31 12 6 863 333
BMW 31 12 6 863 335	BMW 31 12 6 863 785
BMW 6 776 417	BMW 6 776 995
BMW 6 776 997	BMW 6 863 333
BMW 6 863 335	BMW 6 863 785

**Application info**

BMW X5 (E70) (02/06-07/13)	BMW X5 (F15) (08/13-07/18)
BMW X6 (E71) (06/07-07/14)	BMW X6 (F16) (08/14-07/19)

**Control arm**

316 050 0035

MCA0462

**Notes**

Control Arm  
Front Axle Right  
Lower  
Rear  
Steel  
with rubber mount



Length [mm] 343  
Paired article number 316 050 0036 | MCA0463  
Required quantity 1  
Thread Size M14x1,5  
replacement in pairs recommended

**References**

BMW 31 12 6 771 894

BMW 6 771 894

**Application info**

BMW X5 (E70) (02/06-07/13)

BMW X6 (E71) (06/07-07/14)

**Control arm****316 050 0036****MCA0463****Notes**

Control Arm  
 Front Axle Left  
 Lower  
 Rear  
 Steel  
 with rubber mount

Length [mm]

343

Paired article number

316 050 0035 | MCA0462

Required quantity

1

Thread Size

M14x1,5

replacement in pairs recommended

**References**

BMW 31 12 6 771 893

BMW 6 771 893

**Application info**

BMW X5 (E70) (02/06-07/13)

BMW X6 (E71) (06/07-07/14)

**Control arm****316 050 0037/HD****MCA0464HD****Notes**

Carbon Neutral  
 Control Arm  
 Front  
 Front Axle Right  
 Lower  
 Steel  
 with rubber mount

Article number of recommended accessori

314 654 0006

Length [mm]

414

Paired article number

316 050 0038/HD | MCA0465HD

Replace in pairs only

Required quantity

1

Thread Size

M14x1,5

reinforced version





**References**

BMW 31 12 6 773 950

BMW 6 773 950

**Application info**

BMW X5 (E70) (02/06-07/13)

BMW X6 (E71) (06/07-07/14)

**Control arm**

316 050 0038/HD

MCA0465HD

**Notes**

Carbon Neutral  
Control Arm  
Front  
Front Axle Left  
Lower  
Steel  
with rubber mount



Article number of recommended accessories 314 654 0006  
Length [mm] 414  
Paired article number 316 050 0037/HD | MCA0464HD  
Replace in pairs only  
Required quantity 1  
Thread Size M14x1,5  
reinforced version

**References**

BMW 31 12 6 773 949

BMW 6 773 949

**Application info**

BMW X5 (E70) (02/06-07/13)

BMW X6 (E71) (06/07-07/14)

**Control arm**

316 050 0039

MCA0466

**Notes**

Aluminium  
Control Arm  
Front  
Rear Axle Left  
Upper  
with rubber mount



Length [mm] 212  
Paired article number 316 050 0040 | MCA0467  
Required quantity 1  
Thread Size M12x1,5  
replacement in pairs recommended

**References**

BMW 33 32 4 046 917	BMW 33 32 6 770 963
BMW 33 32 6 779 387	BMW 33 32 6 795 047
BMW 4 046 917	BMW 6 770 963
BMW 6 779 387	BMW 6 795 047

**Application info**

BMW X5 (E70) (02/06-07/13)	BMW X5 (F15) (08/13-07/18)
BMW X6 (E71) (06/07-07/14)	BMW X6 (F16) (08/14-07/19)

**Control arm**

316 050 0040

MCA0467

**Notes**

Aluminium  
Control Arm  
Front  
Rear Axle Right  
Upper  
with rubber mount  
Length [mm] 212  
Paired article number 316 050 0039 | MCA0466  
Required quantity 1  
Thread Size M12x1,5  
replacement in pairs recommended





**References**

BMW 33 32 4 046 918	BMW 33 32 6 770 964
BMW 33 32 6 779 388	BMW 33 32 6 795 048
BMW 4 046 918	BMW 6 770 964
BMW 6 779 388	BMW 6 795 048

**Application info**

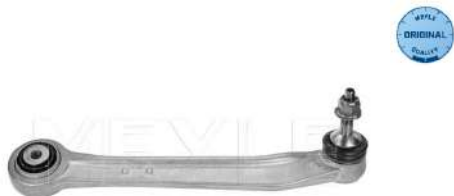
BMW X5 (E70) (02/06-07/13)	BMW X5 (F15) (08/13-07/18)
BMW X6 (E71) (06/07-07/14)	BMW X6 (F16) (08/14-07/19)

Control arm		316 050 0041	MCA0468
<b>Notes</b>  Aluminium Control Arm Rear Rear Axle Left Upper with rubber mount  Length [mm] 344 Paired article number 316 050 0042   MCA0469 Required quantity 1 Thread Size M14x1,5 replacement in pairs recommended			
<b>References</b> BMW 33 32 6 770 969 BMW 33 32 6 796 001 BMW 6 770 969 BMW 6 796 001			
<b>Application info</b> BMW X5 (E70) (02/06-07/13) BMW X5 (F15) (08/13-07/18) BMW X6 (E71) (06/07-07/14) BMW X6 (F16) (08/14-07/19)			
Control arm		316 050 0042	MCA0469
<b>Notes</b>  Aluminium Control Arm Rear Rear Axle Right Upper with rubber mount  Length [mm] 344 Paired article number 316 050 0041   MCA0468 Required quantity 1 Thread Size M14x1,5 replacement in pairs recommended			
<b>References</b> BMW 33 32 6 770 970 BMW 33 32 6 796 002 BMW 6 770 970 BMW 6 796 002			
<b>Application info</b> BMW X5 (E70) (02/06-07/13) BMW X5 (F15) (08/13-07/18) BMW X6 (E71) (06/07-07/14) BMW X6 (F16) (08/14-07/19)			

**Control arm** **316 050 0044/HD** **MCA0470HD**

**Notes**

Aluminium  
 Carbon Neutral  
 Control Arm  
 Front Axle Left  
 Front Axle Right  
 Upper  
 can be adjusted three times  
 with ball joint  
 with rubber mount

Camber correction [min.] -30  
 Camber correction [min.] 30  
 Replace in pairs only  
 Required quantity 2  
 reinforced version



**References**

- |                                  |                            |
|----------------------------------|----------------------------|
| BMW 2 450 817                    | BMW 31 12 2 450 817        |
| BMW 31 12 6 775 967              | BMW 31 12 6 779 871        |
| BMW 31 12 6 779 908              | BMW 31 12 6 854 613        |
| BMW 31 12 6 854 614              | BMW 31 12 6 857 516        |
| BMW 6 775 967                    | BMW 6 779 871              |
| BMW 6 779 908                    | BMW 6 854 613              |
| BMW 6 854 614                    | BMW 6 857 516              |
| BMW (Brilliance) 31 12 6 775 967 | BMW (Brilliance) 6 775 967 |

**Application info**

- |                                |  |
|--------------------------------|--|
| BMW 5 (F07) (01/09-02/17)      | BMW 5 (F10, F11) (01/09-02/17)           |
| BMW 6 (F12, F13) (12/10-10/18) | BMW 7 (F01, F02, F03, F04) (02/08-12/15) |
| BMW i8 (03/14-06/20)           |  |

**Control arm** **316 050 0045** **MCA0471**

**Notes**

Control Arm  
 Front  
 Front Axle Left  
 Front Axle Right  
 Steel  
 Length [mm] 275  
 Required quantity 2  
 Thread Size M14x1,5  
 replacement in pairs recommended



**References**

BMW 2 405 863

BMW 31 12 6 768 989

BMW (Brilliance) 31 12 6 768 989

BMW 31 12 2 405 863

BMW 6 768 989

BMW (Brilliance) 6 768 989

**Application info**

BMW 3 (E90, E91, E92, E93) (02/04-12/13)

BMW X1 (E84) (03/09-06/15)

**Control arm**

316 050 0046/HD

MCA1149HD

**Notes**

Carbon Neutral  
Control Arm  
Front Axle Left  
Rear  
Steel  
with fastening material  
with rubber mount

Length [mm]

385

Paired article number

316 050 0047/HD | MCA1150HD

Replace in pairs only

Required quantity

1

reinforced version



**References**

BMW 31 12 6 768 983

BMW (Brilliance) 31 12 6 768 983



BMW 6 768 983



BMW (Brilliance) 6 768 983



**Application info**

BMW 3 (E90, E91, E92, E93) (02/04-12/13)



BMW X1 (E84) (03/09-06/15)

Control arm		316 050 0047/HD	MCA1150HD
<p><b>Notes</b></p> <p>Carbon Neutral Control Arm Front Axle Right Rear Steel with fastening material with rubber mount</p> <p>Length [mm] 385 Paired article number 316 050 0046/HD   MCA1149HD Replace in pairs only Required quantity 1 reinforced version</p>			
<p><b>References</b></p> <p>BMW 31 12 6 768 984 BMW 6 768 984 BMW (Brilliance) 31 12 6 768 984 BMW (Brilliance) 6 768 984</p>			
<p><b>Application info</b></p> <p>BMW 3 (E90, E91, E92, E93) (02/04-12/13) BMW X1 (E84) (03/09-06/15)</p>			
Control arm		316 050 0048	MCA0472
<p><b>Notes</b></p> <p>Aluminium Control Arm Front Axle Left Lower Rear with rubber mount</p> <p>Length [mm] 306 Paired article number 316 050 0049   MCA0473 Required quantity 1 Thread Size M16x1,5 replacement in pairs recommended</p>			
<p><b>References</b></p> <p>BMW 2 450 813 BMW 31 12 2 450 813 BMW 31 12 6 794 203 BMW 6 794 203 BMW (Brilliance) 31 12 6 794 203 BMW (Brilliance) 6 794 203</p>			
<p><b>Application info</b></p> <p>BMW 5 (F10, F11) (01/09-02/17) BMW 6 (F12, F13) (12/10-10/18)</p>			

Control arm		316 050 0049	MCA0473
<p><b>Notes</b></p> <p>Aluminium Control Arm Front Axle Right Lower Rear with rubber mount</p> <p>Length [mm] 306 Paired article number 316 050 0048   MCA0472 Required quantity 1 Thread Size M16x1,5 replacement in pairs recommended</p>			
<p><b>References</b></p> <p>BMW 2 450 814 BMW 31 12 2 450 814 BMW 31 12 6 794 204 BMW 6 794 204</p>			
<p><b>Application info</b></p> <p>BMW 5 (F10, F11) (01/09-02/17) BMW 6 (F12, F13) (12/10-10/18)</p>			
Control arm		316 050 0050	MCA0474
<p><b>Notes</b></p> <p>Aluminium Control Arm Front Front Axle Left Lower with rubber mount</p> <p>Length [mm] 398 Paired article number 316 050 0051   MCA0475 Required quantity 1 Thread Size M16x1,5 replacement in pairs recommended</p>			
<p><b>References</b></p> <p>BMW 2 450 815 BMW 31 12 2 450 815 BMW 31 12 6 775 971 BMW 6 775 971 BMW (Brilliance) 31 12 6 775 971 BMW (Brilliance) 6 775 971</p>			
<p><b>Application info</b></p> <p>BMW 5 (F10, F11) (01/09-02/17) BMW 6 (F12, F13) (12/10-10/18)</p>			

Control arm		316 050 0051	MCA0475
<b>Notes</b>  Aluminium Control Arm Front Front Axle Right Lower with rubber mount  Length [mm] 398 Paired article number 316 050 0050   MCA0474 Required quantity 1 Thread Size M16x1,5 replacement in pairs recommended			
<b>References</b> BMW 2 450 818 BMW 31 12 2 450 818 BMW 31 12 6 775 972 BMW 6 775 972 BMW (Brilliance) 31 12 6 775 972 BMW (Brilliance) 6 775 972			
<b>Application info</b> BMW 5 (F10, F11) (01/09-02/17) BMW 6 (F12, F13) (12/10-10/18)			
Control arm		316 050 0052	MCA1193
<b>Notes</b>  Control Arm Front Axle Left Rear Steel with rubber mount  Length [mm] 315 Paired article number 316 050 0053   MCA1194 Required quantity 1 replacement in pairs recommended			
<b>References</b> BMW 2 450 843 BMW 31 12 2 450 843 BMW 31 12 6 777 743 BMW 31 12 6 850 605 BMW 6 777 743 BMW 6 850 605			
<b>Application info</b> BMW 5 (F07) (01/09-02/17) BMW 5 (F10, F11) (01/09-02/17) BMW 6 (F12, F13) (12/10-10/18)			

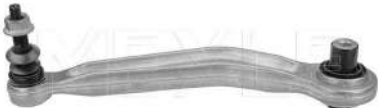

Control arm		316 050 0053	MCA1194
<p><b>Notes</b></p> <p>Control Arm Front Axle Right Rear Steel with rubber mount</p> <p>Length [mm] 315 Paired article number 316 050 0052   MCA1193 Required quantity 1 replacement in pairs recommended</p>		 	
<p><b>References</b></p> <p>BMW 2 450 844 BMW 31 12 2 450 844 BMW 31 12 6 777 744 BMW 31 12 6 850 606 BMW 6 777 744 BMW 6 850 606</p>			
<p><b>Application info</b></p> <p>BMW 5 (F07) (01/09-02/17) BMW 5 (F10, F11) (01/09-02/17) BMW 6 (F12, F13) (12/10-10/18)</p>			
Control arm		316 050 0054	MCA0476
<p><b>Notes</b></p> <p>Aluminium Control Arm Rear Axle Left Upper with accessories with rubber mount</p> <p>Length [mm] 306 Paired article number 316 050 0055   MCA0477 Required quantity 1 Thread Size M14x1,5 replacement in pairs recommended</p>		 	

**References**

- |                            |                                  |
|----------------------------|----------------------------------|
| BMW 1 090 815              | BMW 1 094 209                    |
| BMW 2 347 991              | BMW 2 347 993                    |
| BMW 33 30 6 772 241        | BMW 33 30 6 773 941              |
| BMW 33 32 1 090 815        | BMW 33 32 1 094 209              |
| BMW 33 32 2 347 991        | BMW 33 32 2 347 993              |
| BMW 33 32 6 758 141        | BMW 33 32 6 759 157              |
| BMW 33 32 6 767 753        | BMW 33 32 6 767 759              |
| BMW 33 32 6 767 831        | BMW 33 32 6 767 967              |
| BMW 33 32 6 768 789        | BMW 33 32 6 769 971              |
| BMW 33 32 6 770 775        | BMW 33 32 6 770 839              |
| BMW 33 32 6 774 793        | BMW 33 32 6 774 841              |
| BMW 33 32 6 777 425        | BMW 6 758 141                    |
| BMW 6 759 157              | BMW 6 767 753                    |
| BMW 6 767 759              | BMW 6 767 831                    |
| BMW 6 767 967              | BMW 6 768 789                    |
| BMW 6 769 971              | BMW 6 770 775                    |
| BMW 6 770 839              | BMW 6 772 241                    |
| BMW 6 773 941              | BMW 6 774 793                    |
| BMW 6 774 841              | BMW 6 777 425                    |
| BMW (Brilliance) 2 347 991 | BMW (Brilliance) 33 32 2 347 991 |

**Application info**

- |                                |                                |
|--------------------------------|--------------------------------|
| BMW 5 (E39) (09/95-06/04)      | BMW 5 (E60, E61) (12/01-12/10) |
| BMW 6 (E63, E64) (09/03-12/10) | BMW 7 (E65, E66) (07/01-12/09) |

**Control arm**

**316 050 0055**

**MCA0477**

**Notes**

Aluminium  
Control Arm  
Rear Axle Right  
Upper  
with accessories  
with rubber mount

Length [mm] 306  
Paired article number 316 050 0054 | MCA0476  
Required quantity 1  
Thread Size M14x1,5

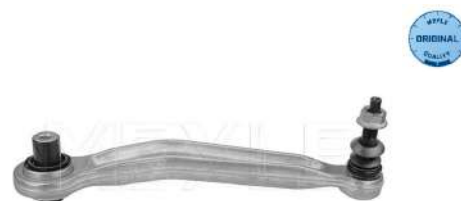

replacement in pairs recommended

**References**

BMW 1 090 816	BMW 1 094 210
BMW 2 347 990	BMW 2 347 992
BMW 33 30 6 772 242	BMW 33 30 6 773 942
BMW 33 32 1 090 816	BMW 33 32 1 094 210
BMW 33 32 2 347 990	BMW 33 32 2 347 992
BMW 33 32 6 758 142	BMW 33 32 6 759 158
BMW 33 32 6 767 754	BMW 33 32 6 767 760
BMW 33 32 6 767 832	BMW 33 32 6 767 968
BMW 33 32 6 768 790	BMW 33 32 6 769 972
BMW 33 32 6 770 776	BMW 33 32 6 770 840
BMW 33 32 6 774 794	BMW 33 32 6 774 842
BMW 33 32 6 777 426	BMW 6 758 142
BMW 6 759 158	BMW 6 767 754
BMW 6 767 760	BMW 6 767 832
BMW 6 767 968	BMW 6 768 790
BMW 6 769 972	BMW 6 770 776
BMW 6 770 840	BMW 6 772 242
BMW 6 773 942	BMW 6 774 794
BMW 6 774 842	BMW 6 777 426
BMW (Brilliance) 2 347 990	BMW (Brilliance) 33 32 2 347 990

**Application info**

BMW 5 (E39) (09/95-06/04)	BMW 5 (E60, E61) (12/01-12/10)
BMW 6 (E63, E64) (09/03-12/10)	BMW 7 (E65, E66) (07/01-12/09)

**Control arm****316 050 0056****MCA0478****Notes**

Aluminium  
Control Arm  
Front Axle Left  
Rear  
with rubber mount

Length [mm]	313
Paired article number	316 050 0057   MCA0479
Required quantity	1
Thread Size	M16x1,5
replacement in pairs recommended	

**References**

BMW 31 12 6 775 963	BMW 31 12 6 798 107
BMW 31 12 6 850 781	BMW 6 775 963
BMW 6 798 107	BMW 6 850 781

**Application info**

BMW 5 (F07) (01/09-02/17)

BMW 7 (F01, F02, F03, F04) (02/08-12/15)

**Control arm**

**316 050 0057**

**MCA0479**

**Notes**

Aluminium  
Control Arm  
Front Axle Right  
Rear  
with rubber mount

Length [mm] 313  
Paired article number 316 050 0056 | MCA0478  
Required quantity 1  
Thread Size M16x1,5  
replacement in pairs recommended



**References**

BMW 31 12 6 775 964  
BMW 31 12 6 850 782  
BMW 6 798 108

BMW 31 12 6 798 108  
BMW 6 775 964  
BMW 6 850 782

**Application info**

BMW 5 (F07) (01/09-02/17)

BMW 7 (F01, F02, F03, F04) (02/08-12/15)

**Control arm**

**316 050 0058**

**MCA0790**

**Notes**

Cast Steel  
Control Arm  
Front Axle Left  
Rear  
with rubber mount

Length [mm] 295  
Paired article number 316 050 0059 | MCA0791  
Required quantity 1  
Thread Size M14x1,5  
replacement in pairs recommended



**References**

BMW 2 457 391  
BMW 31 12 2 457 391  
BMW 6 787 669

BMW 31 10 6 787 669  
BMW 31 12 6 787 669

**Application info**

BMW X3 (F25) (09/10-08/17)

BMW X4 (F26) (05/13-03/18)

**Control arm**

316 050 0059

MCA0791

**Notes**

Cast Steel  
Control Arm  
Front Axle Right  
Rear  
with rubber mount

Length [mm]

295

Paired article number

316 050 0058 | MCA0790

Required quantity

1

Thread Size

M14x1,5

replacement in pairs recommended



**References**

BMW 2 457 392

BMW 31 10 6 787 670

BMW 31 12 2 457 392

BMW 31 12 6 787 670

BMW 6 787 670

**Application info**

BMW X3 (F25) (09/10-08/17)

BMW X4 (F26) (05/13-03/18)

**Control arm**

316 050 0060

MCA0480

**Notes**

Cast Steel  
Control Arm  
Front  
Front Axle Left  
with rubber mount

Length [mm]

425

Paired article number

316 050 0061 | MCA0481

Required quantity

1

replacement in pairs recommended



**References**



BMW 31 10 6 787 673





BMW 6 787 673

**Application info**

BMW X3 (F25) (09/10-08/17)

BMW X4 (F26) (05/13-03/18)

Control arm		316 050 0061	MCA0481
<b>Notes</b>  Cast Steel Control Arm Front Front Axle Right with rubber mount  Length [mm] 425 Paired article number 316 050 0060   MCA0480 Required quantity 1 replacement in pairs recommended			
<b>References</b> BMW 31 10 6 787 674		BMW 6 787 674	
<b>Application info</b> BMW X3 (F25) (09/10-08/17)		BMW X4 (F26) (05/13-03/18)	
Control arm		316 050 0062/HD	MCA1238HD
<b>Notes</b>  Aluminium Carbon Neutral Control Arm Front Front Axle Left with rubber mount  Article number of recommended accessori 314 654 0022 Length [mm] 402 Paired article number 316 050 0063/HD   MCA1239HD Replace in pairs only Required quantity 1 Thread Size M16x1,5 reinforced version			
<b>References</b> BMW 31 12 4 083 311 BMW 4 083 311		BMW 31 12 6 775 959 BMW 6 775 959	
<b>Application info</b> BMW 5 (F07) (01/09-02/17)		BMW 7 (F01, F02, F03, F04) (02/08-12/15)	

Control arm		316 050 0063/HD	MCA1239HD
<b>Notes</b>  Aluminium Carbon Neutral Control Arm Front Front Axle Right with rubber mount  Article number of recommended accessories 314 654 0021 Length [mm] 402 Paired article number 316 050 0062/HD   MCA1238HD Replace in pairs only Required quantity 1 Thread Size M16x1,5 reinforced version		 	
<b>References</b> BMW 31 12 4 083 312 BMW 4 083 312		BMW 31 12 6 775 960 BMW 6 775 960	
<b>Application info</b> BMW 5 (F07) (01/09-02/17)		BMW 7 (F01, F02, F03, F04) (02/08-12/15)	
Control arm		316 050 0066/HD	MCA1151HD
<b>Notes</b>  Aluminium Carbon Neutral Control Arm Front Axle Left with fastening material with rubber mount  Article number of recommended accessories 314 654 0003 Length [mm] 390 Paired article number 316 050 0067/HD   MCA1152HD Replace in pairs only Required quantity 1 Thread Size M14x1,5 reinforced version		 	
<b>References</b> BMW 31 12 6 851 259 BMW 6 851 259 BMW (Brilliance) 31 12 6 855 741		BMW 31 12 6 855 741 BMW 6 855 741 BMW (Brilliance) 6 855 741	

**Application info**

BMW 1 (F20, F21) (07/11--)

BMW 3 (F30, F31) (11/11-06/19)

BMW 4 (F32, F33, F36) (07/13--)

BMW 2 (F22,F23) (10/12--)

BMW 3 (F34) (07/12--)

**Control arm**

316 050 0067/HD

MCA1152HD

**Notes**

Aluminium  
Carbon Neutral  
Control Arm  
Front Axle Right  
with fastening material  
with rubber mount

Article number of recommended accessories: 314 654 0003  
Length [mm]: 390  
Paired article number: 316 050 0066/HD | MCA1151HD  
Replace in pairs only  
Required quantity: 1  
Thread Size: M14x1,5  
reinforced version



**References**

BMW 31 12 6 851 260

BMW 6 851 260

BMW (Brilliance) 31 12 6 855 742

BMW 31 12 6 855 742

BMW 6 855 742

BMW (Brilliance) 6 855 742

**Application info**

BMW 1 (F20, F21) (07/11--)

BMW 3 (F30, F31) (11/11-06/19)

BMW 4 (F32, F33, F36) (07/13--)

BMW 2 (F22,F23) (10/12--)

BMW 3 (F34) (07/12--)



Control arm		316 050 0068/HD	MCA1211HD
<b>Notes</b>			
	Aluminium		
	Carbon Neutral		
	Control Arm		
	Front Axle Left		
	with rubber mount		
Article number of recommended accessory	314 654 0007		
Length [mm]	385		
Paired article number	316 050 0069/HD   MCA1212HD		
Replace in pairs only			
Required quantity	1		
Thread Size	M14x1,5		
reinforced version			

References			
BMW 31 12 6 854 723		BMW 6 854 723	
BMW (Brilliance) 31 12 6 854 723		BMW (Brilliance) 6 854 723	

Application info			
BMW 1 (F20, F21) (07/11--)		BMW 2 (F22,F23) (10/12--)	
BMW 3 (F30, F31) (11/11-06/19)		BMW 4 (F32, F33, F36) (07/13--)	

Control arm		316 050 0069/HD	MCA1212HD
<b>Notes</b>			
	Aluminium		
	Carbon Neutral		
	Control Arm		
	Front Axle Right		
	with rubber mount		
Article number of recommended accessory	314 654 0007		
Length [mm]	385		
Paired article number	316 050 0068/HD   MCA1211HD		
Replace in pairs only			
Required quantity	1		
Thread Size	M14x1,5		
reinforced version			

References			
BMW 31 12 6 854 724		BMW 6 854 724	
BMW (Brilliance) 31 12 6 854 724		BMW (Brilliance) 6 854 724	

**Application info**

BMW 1 (F20, F21) (07/11--)  
 BMW 3 (F30, F31) (11/11-06/19)

BMW 2 (F22,F23) (10/12--)  
 BMW 4 (F32, F33, F36) (07/13--)

**Control arm**

316 050 0070

MCA1308

**Notes**

Control Arm  
 Rear  
 Rear Axle Left  
 Rear Axle Right  
 Sheet Steel  
 Upper

Required quantity  
 replacement in pairs recommended



**References**

BMW 33 32 6 786 981

BMW 6 786 981

**Application info**

BMW X3 (F25) (09/10-08/17)

BMW X4 (F26) (05/13-03/18)

**Control arm**

316 050 0071

MCA1305

**Notes**

Centre  
 Control Arm  
 Lower  
 Rear Axle Left  
 Rear Axle Right  
 Sheet Steel

Required quantity  
 replacement in pairs recommended



**References**

BMW 33 32 6 795 812

BMW 6 795 812

**Application info**

BMW X3 (F25) (09/10-08/17)

BMW X4 (F26) (05/13-03/18)

**Control arm** **316 050 0072** **MCA1293**

**Notes**

Control Arm  
 Front  
 Lower  
 Rear Axle Left  
 Rear Axle Right  
 Sheet Steel

Required quantity  
 replacement in pairs recommended

2



**References**

BMW 33 32 6 786 978

BMW 6 786 978

**Application info**

BMW X3 (F25) (09/10-08/17)

BMW X4 (F26) (05/13-03/18)

**Control arm** **316 050 0083** **MCA0826**

**Notes**

Aluminium  
 Control Arm  
 Front Axle Left  
 Rear  
 with ball joint  
 with rubber mount

Paired article number

316 050 0084 | MCA0827

Required quantity

1

replacement in pairs recommended



**References**

BMW 31 12 6 852 991

BMW 6 852 991

BMW (Brilliance) 31 12 6 852 991

BMW (Brilliance) 6 852 991

**Application info**



BMW 1 (F20, F21) (07/11--)



BMW 2 (F22,F23) (10/12--)



BMW 3 (F30, F31) (11/11-06/19)

BMW 3 (F34) (07/12--)

BMW 4 (F32, F33, F36) (07/13--)

Control arm		316 050 0084	MCA0827
<p><b>Notes</b></p> <p>Aluminium Control Arm Front Axle Right Rear with ball joint with rubber mount</p> <p>Paired article number 316 050 0083   MCA0826</p> <p>Required quantity 1</p> <p>replacement in pairs recommended</p>			
<p><b>References</b></p> <p>BMW 31 12 6 852 992 BMW 6 852 992</p> <p>BMW (Brilliance) 31 12 6 852 992 BMW (Brilliance) 6 852 992</p>			
<p><b>Application info</b></p> <p>BMW 1 (F20, F21) (07/11--)</p> <p>BMW 2 (F22,F23) (10/12--)</p> <p>BMW 3 (F30, F31) (11/11-06/19)</p> <p>BMW 3 (F34) (07/12--)</p> <p>BMW 4 (F32, F33, F36) (07/13--)</p>			
Control arm		316 050 0085/S	MCA1113
<p><b>Notes</b></p> <p>Aluminium Control Arm Rear Axle Left Rear Axle Right with fastening material</p> <p>Required quantity 2</p> <p>replacement in pairs recommended</p>			
<p><b>References</b></p> <p>BMW 33 32 6 775 902 BMW 6 775 902</p>			
<p><b>Application info</b></p> <p>BMW 5 (F10, F11) (01/09-02/17)</p> <p>BMW 6 (F12, F13) (12/10-10/18)</p> <p>BMW 7 (F01, F02, F03, F04) (02/08-12/15)</p>			

Control arm		316 050 0092	MCA1182
<p><b>Notes</b></p> <p>Cast Steel Control Arm Front Axle Right with ball joint</p> <p>Paired article number Required quantity replacement in pairs recommended</p>			
<p><b>References</b></p> <p>Mini 2 444 414 Mini 31 12 9 804 432 Mini 9 804 432</p>		<p>Mini 31 12 2 444 414 Mini 31 12 9 806 520 Mini 9 806 520</p>	
<p><b>Application info</b></p> <p>Mini Countryman I (08/10-10/16)</p>		<p>Mini Paceman (03/12-10/16)</p>	
Control arm		316 050 0093	MCA1183
<p><b>Notes</b></p> <p>Cast Steel Control Arm Front Axle Left with ball joint</p> <p>Paired article number Required quantity replacement in pairs recommended</p>			
<p><b>References</b></p> <p>Mini 2 444 415 Mini 31 12 9 804 431 Mini 9 804 431</p>		<p>Mini 31 12 2 444 415 Mini 31 12 9 806 519 Mini 9 806 519</p>	
<p><b>Application info</b></p> <p>Mini Countryman I (08/10-10/16)</p>		<p>Mini Paceman (03/12-10/16)</p>	

Control arm		316 050 0094	MCA1146
<p><b>Notes</b></p> <p>Aluminium Control Arm Front Lower Rear Axle Left Rear Axle Right with rubber mount</p> <p>Required quantity replacement in pairs recommended</p>			
<p><b>References</b></p> <p>BMW 33 32 6 775 683 BMW (Brilliance) 33 32 6 775 683</p>		<p>BMW 6 775 683 BMW (Brilliance) 6 775 683</p>	
<p><b>Application info</b></p> <p>BMW 5 (F07) (01/09-02/17) BMW 6 (F12, F13) (12/10-10/18)</p>		<p>BMW 5 (F10, F11) (01/09-02/17) BMW 7 (F01, F02, F03, F04) (02/08-12/15)</p>	
Control arm		316 050 0095/HD	MCA1004HD
<p><b>Notes</b></p> <p>Aluminium Carbon Neutral Control Arm Front Axle Left with rubber mount</p> <p>Article number of recommended accessory 314 654 0019 Paired article number 316 050 0096/HD   MCA1005HD Replace in pairs only Required quantity reinforced version 1</p>			
<p><b>References</b></p> <p>BMW 31 10 6 770 685</p>		<p>BMW 6 770 685</p>	
<p><b>Application info</b></p> <p>BMW 5 (E60, E61) (12/01-12/10)</p>		<p>Toyota Avensis (T27) (11/08-10/18)</p>	

**Control arm**

**316 050 0096/HD**

**MCA1005HD**

**Notes**

Aluminium  
Carbon Neutral  
Control Arm  
Front Axle Right  
with rubber mount

Article number of recommended accessories: 314 654 0019  
Paired article number: 316 050 0095/HD | MCA1004HD  
Replace in pairs only  
Required quantity: 1  
reinforced version



**References**

BMW 31 10 6 770 686

BMW 6 770 686

**Application info**

BMW 5 (E60, E61) (12/01-12/10)

**Control arm**

**316 050 0097/HD**

**MCA1157HD**

**Notes**

Aluminium  
Carbon Neutral  
Control Arm  
Front  
Front Axle Left  
Lower  
with fastening material  
with rubber mount

Paired article number: 316 050 0098/HD | MCA1158HD  
Replace in pairs only  
Required quantity: 1  
reinforced version





**References**

BMW 2 348 049  
BMW 31 12 4 046 439  
BMW 31 12 6 774 829  
BMW 6 765 997





BMW 31 10 2 348 049  
BMW 31 12 6 765 997  
BMW 4 046 439  
BMW 6 774 829

**Application info**

BMW 6 (E63, E64) (09/03-12/10)

Control arm	316 050 0098/HD	MCA1158HD								
<p><b>Notes</b></p> <p>Aluminium Carbon Neutral Control Arm Front Front Axle Right Lower with fastening material with rubber mount</p> <p>Paired article number Replace in pairs only Required quantity reinforced version</p>	<p>Aluminium Carbon Neutral Control Arm Front Front Axle Right Lower with fastening material with rubber mount</p> <p>316 050 0097/HD   MCA1157HD</p> <p>1</p>	 <p>MEYLE HD REINFORCED</p>								
<p><b>References</b></p> <table border="0" style="width: 100%;"> <tr> <td>BMW 2 348 048</td> <td>BMW 31 10 2 348 048</td> </tr> <tr> <td>BMW 31 12 4 046 440</td> <td>BMW 31 12 6 765 998</td> </tr> <tr> <td>BMW 31 12 6 774 830</td> <td>BMW 4 046 440</td> </tr> <tr> <td>BMW 6 765 998</td> <td>BMW 6 774 830</td> </tr> </table>			BMW 2 348 048	BMW 31 10 2 348 048	BMW 31 12 4 046 440	BMW 31 12 6 765 998	BMW 31 12 6 774 830	BMW 4 046 440	BMW 6 765 998	BMW 6 774 830
BMW 2 348 048	BMW 31 10 2 348 048									
BMW 31 12 4 046 440	BMW 31 12 6 765 998									
BMW 31 12 6 774 830	BMW 4 046 440									
BMW 6 765 998	BMW 6 774 830									
<p><b>Application info</b> BMW 6 (E63, E64) (09/03-12/10)</p>										
Control arm	316 050 0099	MCA1031								
<p><b>Notes</b></p> <p>Aluminium Control Arm Rear Axle Left Rear Axle Right with rubber mount</p> <p>Required quantity replacement in pairs recommended</p>	<p>Aluminium Control Arm Rear Axle Left Rear Axle Right with rubber mount</p> <p>2</p>	 <p>MEYLE ORIGINAL</p>								
<p><b>References</b></p> <table border="0" style="width: 100%;"> <tr> <td>BMW 2 450 891</td> <td>BMW 33 32 2 450 891</td> </tr> <tr> <td>BMW 33 32 4 069 469</td> <td>BMW 33 32 6 779 851</td> </tr> <tr> <td>BMW 4 069 469</td> <td>BMW 6 779 851</td> </tr> </table>			BMW 2 450 891	BMW 33 32 2 450 891	BMW 33 32 4 069 469	BMW 33 32 6 779 851	BMW 4 069 469	BMW 6 779 851		
BMW 2 450 891	BMW 33 32 2 450 891									
BMW 33 32 4 069 469	BMW 33 32 6 779 851									
BMW 4 069 469	BMW 6 779 851									
<p><b>Application info</b> BMW 5 (F07) (01/09-02/17)</p> <p>BMW 5 (F10, F11) (01/09-02/17)</p>										



Control arm		316 050 0113	MCA1309
<p><b>Notes</b></p> <p>Control Arm Front Axle Left Lower Rear Steel</p> <p>Paired article number 316 050 0114   MCA1310 Required quantity 1 replacement in pairs recommended</p>		 	
<p><b>References</b></p> <p>BMW 31 12 6 864 821 BMW 6 864 821</p>			
<p><b>Application info</b></p> <p>BMW X5 (F15) (08/13-07/18) BMW X6 (F16) (08/14-07/19)</p>			
Control arm		316 050 0114	MCA1310
<p><b>Notes</b></p> <p>Control Arm Front Axle Right Lower Rear Steel</p> <p>Paired article number 316 050 0113   MCA1309 Required quantity 1 replacement in pairs recommended</p>		 	
<p><b>References</b></p> <p>BMW 31 12 6 864 822 BMW 6 864 822</p>			
<p><b>Application info</b></p> <p>BMW X5 (F15) (08/13-07/18) BMW X6 (F16) (08/14-07/19)</p>			

<b>Control arm</b>	<b>316 050 0115/HD</b>	<b>MCA1370HD</b>
--------------------	------------------------	------------------

<p><b>Notes</b></p> <p style="margin-left: 20px;">Carbon Neutral Control Arm Front Axle Left Steel with rubber mount</p> <p>Article number of recommended accessories: 314 654 0020 Paired article number: 316 050 0116/HD   MCA1371HD Replace in pairs only Required quantity: 1 reinforced version</p>	
--	---

<b>References</b>			
BMW 31 12 6 851 691		BMW 31 12 6 863 169	
BMW 6 851 691		BMW 6 863 169	



<b>Application info</b>			
BMW X5 (E70) (02/06-07/13)		BMW X5 (F15) (08/13-07/18)	
BMW X6 (E71) (06/07-07/14)		BMW X6 (F16) (08/14-07/19)	





<b>Control arm</b>	<b>316 050 0116/HD</b>	<b>MCA1371HD</b>
--------------------	------------------------	------------------

<p><b>Notes</b></p> <p style="margin-left: 20px;">Carbon Neutral Control Arm Front Axle Right Steel with rubber mount</p> <p>Article number of recommended accessories: 314 654 0020 Paired article number: 316 050 0115/HD   MCA1370HD Replace in pairs only Required quantity: 1 reinforced version</p>	
---	---

<b>References</b>			
BMW 31 12 6 851 692		BMW 31 12 6 863 170	
BMW 6 851 692		BMW 6 863 170	

<b>Application info</b>			
BMW X5 (E70) (02/06-07/13)		BMW X5 (F15) (08/13-07/18)	
BMW X6 (E71) (06/07-07/14)		BMW X6 (F16) (08/14-07/19)	

Control arm		316 050 0119/HD	MCA1240HD
<p><b>Notes</b></p> <p>Aluminium Carbon Neutral Control Arm Front Front Axle Left Lower with ball joint with rubber mount</p> <p>Article number of recommended accessories 314 654 0023 Paired article number 316 050 0120/HD   MCA1241HD Replace in pairs only Required quantity 1 reinforced version</p>			
<p><b>References</b></p> <p>BMW 31 12 6 798 253 BMW 6 798 253</p>			
<p><b>Application info</b></p> <p>BMW 3 (F34) (07/12--)</p> <p>BMW 4 (F32, F33, F36) (07/13--)</p>			
Control arm		316 050 0120/HD	MCA1241HD
<p><b>Notes</b></p> <p>Aluminium Carbon Neutral Control Arm Front Front Axle Right Lower with ball joint with rubber mount</p> <p>Article number of recommended accessories 314 654 0023 Paired article number 316 050 0119/HD   MCA1240HD Replace in pairs only Required quantity 1 reinforced version</p>			
<p><b>References</b></p> <p>BMW 31 12 6 798 254 BMW 6 798 254</p>			
<p><b>Application info</b></p> <p>BMW 3 (F34) (07/12--)</p> <p>BMW 4 (F32, F33, F36) (07/13--)</p>			

Control arm		316 050 0123/S	MCA1110
<b>Notes</b>	<p>Aluminium Control Arm Rear Rear Axle Left Upper with fastening material with rubber mount</p> <p>Paired article number Required quantity replacement in pairs recommended</p>		
<b>References</b>	BMW 33 32 6 779 847	BMW 6 779 847	
<b>Application info</b>	BMW 5 (F07) (01/09-02/17)	BMW 5 (F10, F11) (01/09-02/17)	
Control arm		316 050 0124/S	MCA1111
<b>Notes</b>	<p>Aluminium Control Arm Rear Rear Axle Right Upper with fastening material with rubber mount</p> <p>Paired article number Required quantity replacement in pairs recommended</p>		
<b>References</b>	BMW 33 32 6 779 848	BMW 6 779 848	
<b>Application info</b>	BMW 5 (F07) (01/09-02/17)	BMW 5 (F10, F11) (01/09-02/17)	

**Control arm** **316 050 0129** **MCA1228**

**Notes**

Rear Axle Left  
 Rear Axle Right  
 Sheet Steel  
 Trailing Arm  
 Upper

Required quantity  
 replacement in pairs recommended

2



**References**

BMW 33 32 6 851 563  
 BMW 33 32 6 884 693  
 BMW 6 870 773  
 BMW (Brilliance) 33 32 6 870 773  
 Mini 33 32 6 851 563  
 Mini 33 32 6 884 693  
 Mini 6 870 773

BMW 33 32 6 870 773  
 BMW 6 851 563  
 BMW 6 884 693  
 BMW (Brilliance) 6 870 773  
 Mini 33 32 6 870 773  
 Mini 6 851 563  
 Mini 6 884 693

**Application info**

BMW 1 (F40), 2 Gran Coupe (F44) (07/19--)  
 BMW X1 (F48) (11/14--)  
 Mini Countryman II (10/16--)

BMW 2 (F45, F46) (11/13--)  
 BMW X2 (F39) (11/17--)  
 Mini Mini III (09/13--)

**Control arm** **316 050 0130** **MCA1302**

**Notes**

Lower  
 Rear Axle Left  
 Rear Axle Right  
 Sheet Steel  
 Trailing Arm

Required quantity  
 replacement in pairs recommended

2



**References**

BMW 33 32 6 851 569  
 BMW (Brilliance) 33 32 6 851 569  
 Mini 33 32 6 851 569

BMW 6 851 569  
 BMW (Brilliance) 6 851 569  
 Mini 6 851 569

**Application info**

BMW 1 (F40), 2 Gran Coupe (F44) (07/19--)  
 BMW X1 (F48) (11/14--)  
 Mini Countryman II (10/16--)

BMW 2 (F45, F46) (11/13--)  
 BMW X2 (F39) (11/17--)  
 Mini Mini III (09/13--)

**Control arm**

**316 050 0131/HD**

**MCA1161HD**

**Notes**

Aluminium  
 Carbon Neutral  
 Control Arm  
 Front  
 Front Axle Left  
 Lower  
 with ball joint  
 with rubber mount

Paired article number  
 Replace in pairs only  
 Required quantity  
 reinforced version

316 050 0132/HD | MCA1162HD  
 1



**References**

BMW 2 450 835  
 BMW 31 12 4 083 309  
 BMW 4 083 309

BMW 31 12 2 450 835  
 BMW 31 12 6 777 733  
 BMW 6 777 733

**Application info**

BMW 5 (F10, F11) (01/09-02/17)

BMW 6 (F12, F13) (12/10-10/18)

**Control arm**

**316 050 0132/HD**

**MCA1162HD**

**Notes**

Aluminium  
 Carbon Neutral  
 Control Arm  
 Front  
 Front Axle Right  
 Lower  
 with ball joint  
 with rubber mount

Paired article number  
 Paired article number  
 Replace in pairs only  
 Required quantity  
 reinforced version

316 050 0131 | MCA1161  
 316 050 0131/HD | MCA1161HD  
 1



**References**

BMW 2 450 839

BMW 31 12 4 083 310

BMW 4 083 310

BMW 31 12 2 450 839

BMW 31 12 6 777 734

BMW 6 777 734

**Application info**

BMW 5 (F10, F11) (01/09-02/17)

BMW 6 (F12, F13) (12/10-10/18)

**Control arm**

316 050 0138

MCA1561

**Notes**

Centre  
Control Arm  
Rear Axle Right  
Sheet Steel  
Upper

Paired article number

316 050 0139 | MCA1562

Required quantity

1

replacement in pairs recommended



**References**

BMW 33 30 6 878 018

BMW 6 878 018

**Application info**

BMW X5 (G05) (08/18--)

BMW X7 (G07) (03/19--)

BMW X6 (G06) (08/19--)

**Control arm**

316 050 0139

MCA1562

**Notes**

Centre  
Control Arm  
Rear Axle Left  
Sheet Steel  
Upper

Paired article number

136 050 0138

Paired article number

316 050 0138 | MCA1561

Required quantity

1

replacement in pairs recommended



**References**

BMW 33 30 6 878 017

BMW 6 878 017

**Application info**

BMW X5 (G05) (08/18--)  
BMW X7 (G07) (03/19--)

BMW X6 (G06) (08/19--)

**Control arm**

316 050 0148

MSR0155

**Notes**

Centre  
Control Arm  
Rear  
Rear Axle Right  
Sheet Steel  
with rubber mount

Paired article number  
Required quantity  
replacement in pairs recommended

316 050 0149 | MSR0156  
1

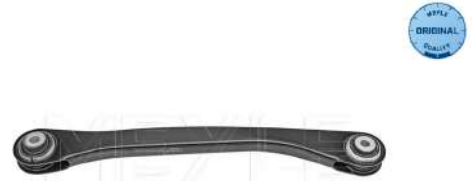

**References**

BMW 33 32 6 861 126

BMW 6 861 126

**Application info**

BMW 5 (G30, G31) (09/16--)  
BMW 7 (G11, G12) (07/15--)  
BMW 8 Gran Coupe (G16) (07/19--)

BMW 6 (G32) (06/17--)  
BMW 8 (G15) (07/18--)

**Control arm**

316 050 0149

MSR0156

**Notes**

Centre  
Control Arm  
Rear  
Rear Axle Left  
Sheet Steel  
with rubber mount

Paired article number  
Required quantity  
replacement in pairs recommended

316 050 0148 | MSR0155  
1



**References**

BMW 33 32 6 861 125

BMW 6 861 125

**Application info**

BMW 5 (G30, G31) (09/16--)  
BMW 7 (G11, G12) (07/15--)  
BMW 8 Gran Coupe (G16) (07/19--)

BMW 6 (G32) (06/17--)  
BMW 8 (G15) (07/18--)



**Control arm****316 050 0150****MCA1520****Notes**

Aluminium  
Control Arm  
Front Axle Left  
Front Axle Right  
Upper

Length [mm]

265.9

Required quantity

2

Width [mm]

237

replacement in pairs recommended

**References**

BMW 31 10 6 868 530

BMW 6 868 530

**Application info**

BMW 6 (G32) (06/17--)

BMW 7 (G11, G12) (07/15--)

**Control arm****316 050 0151/HD****MCA1392HD****Notes**

Aluminium  
Carbon Neutral  
Front Axle Left  
Left  
Lower  
Trailing Arm

Article number of recommended accessories 314 654 0027

Paired article number

Replace in pairs only

Required quantity

1

**References**



BMW 31 10 6 861 151





BMW 6 861 151

**Application info**

BMW 6 (G32) (06/17--)

BMW 7 (G11, G12) (07/15--)

Control arm		316 050 0152/HD	MCA1393HD
<p><b>Notes</b></p> <p>Aluminium Carbon Neutral Front Front Axle Right Lower Trailing Arm</p> <p>Article number of recommended accessori 314 654 0028</p> <p>Paired article number</p> <p>Replace in pairs only</p> <p>Required quantity 1</p>			
<p><b>References</b></p> <p>BMW 31 10 6 861 152 BMW 6 861 152</p>			
<p><b>Application info</b></p> <p>BMW 6 (G32) (06/17--)</p> <p>BMW 7 (G11, G12) (07/15--)</p>			
Control arm		316 050 0153	MCA1379
<p><b>Notes</b></p> <p>Aluminium Front Axle Left Lower Rear Trailing Arm</p> <p>Paired article number 316 050 0154   MCA1380</p> <p>Required quantity 1</p> <p>replacement in pairs recommended</p>			
<p><b>References</b></p> <p>BMW 31 10 6 861 169 BMW 6 861 169</p>			
<p><b>Application info</b></p> <p>BMW 6 (G32) (06/17--)</p> <p>BMW 7 (G11, G12) (07/15--)</p>			

Control arm		316 050 0154	MCA1380
<p><b>Notes</b></p> <p>Aluminium Front Axle Right Lower Rear Trailing Arm</p> <p>Paired article number Required quantity replacement in pairs recommended</p>		 	
<p><b>References</b></p> <p>BMW 31 10 6 861 170</p>		<p>BMW 6 861 170</p>	
<p><b>Application info</b></p> <p>BMW 6 (G32) (06/17--)</p>		<p>BMW 7 (G11, G12) (07/15--)</p>	
Control arm		316 050 0155	MCA1349
<p><b>Notes</b></p> <p>Aluminium Centre Rear Axle Left Trailing Arm Upper</p> <p>Paired article number Required quantity replacement in pairs recommended</p>		 	
<p><b>References</b></p> <p>BMW 2 781 469 BMW 33 32 6 861 119</p>		<p>BMW 33 32 2 781 469 BMW 6 861 119</p>	
<p><b>Application info</b></p> <p>BMW 5 (G30, G31) (09/16--)</p>		<p>BMW 6 (G32) (06/17--)</p>	

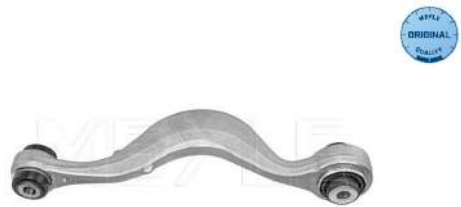
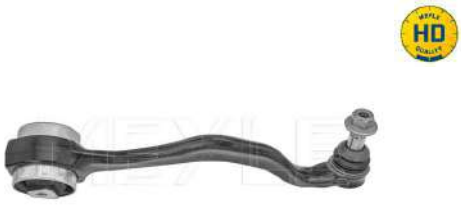
Control arm		316 050 0156	MCA1350
<p><b>Notes</b></p> <p>Aluminium Centre Rear Axle Right Trailing Arm Upper</p> <p>Paired article number 316 050 0155   MCA1349 Required quantity 1 replacement in pairs recommended</p>			
<p><b>References</b></p> <p>BMW 2 781 470 BMW 33 32 2 781 470 BMW 33 32 6 861 120 BMW 6 861 120</p>			
<p><b>Application info</b></p> <p>BMW 5 (G30, G31) (09/16--) BMW 6 (G32) (06/17--)</p>			
Control arm		316 050 0157/HD	MCA1469HD
<p><b>Notes</b></p> <p>Aluminium Carbon Neutral Control Arm Front Front Axle Left Lower</p> <p>Article number of recommended accessori 314 654 0026 Paired article number 316 050 0158/HD   MCA1470HD Replace in pairs only Required quantity 1</p>			
<p><b>References</b></p> <p>BMW 31 10 6 870 977 BMW 31 10 6 890 903 BMW 31 10 6 890 905 BMW 31 10 8 854 989 BMW 31 10 8 854 993 BMW 6 870 977 BMW 6 890 903 BMW 6 890 905 BMW 8 854 989</p>			
<p><b>Application info</b></p> <p>BMW X3 (G01) (07/17--) BMW iX3 (09/20--) BMW X4 (G02) (04/18--)</p>			

**Control arm** **316 050 0158/HD** **MCA1470HD**

**Notes**

Aluminium  
Carbon Neutral  
Control Arm  
Front  
Front Axle Right  
Lower  
with rubber mount



Article number of recommended accessories: 314 654 0026  
Paired article number: 316 050 0157/HD | MCA1469HD  
Replace in pairs only  
Required quantity: 1

**References**

BMW 31 10 6 870 978	BMW 31 10 6 890 904
BMW 31 10 6 890 906	BMW 31 10 8 854 990
BMW 31 10 8 854 994	BMW 6 870 978
BMW 6 890 904	BMW 6 890 906

**Application info**

BMW X3 (G01) (07/17--)  
BMW iX3 (09/20--)  
BMW X4 (G02) (04/18--)

**Control arm** **316 050 0159/HD** **MCA1644HD**

**Notes**

Aluminium  
Control Arm  
Front Axle Left  
Lower  
Rear  
with rubber mount



Article number of recommended accessories: 314 654 0029  
Paired article number: 316 050 0160/HD | MCA1645HD  
Replace in pairs only  
reinforced version

**References**

BMW 31 10 6 870 971	BMW 31 10 6 871 467
BMW 6 870 971	BMW 6 871 467

**Application info**

BMW X3 (G01) (07/17--)  
BMW iX3 (09/20--)

BMW X4 (G02) (04/18--)

**Control arm**

316 050 0160/HD

MCA1645HD

**Notes**

Aluminium  
Control Arm  
Front Axle Right  
Lower  
Rear  
with rubber mount

Article number of recommended accessory 314 654 0029  
Paired article number 316 050 0159/HD | MCA1644HD  
Replace in pairs only



**References**

BMW 31 10 6 870 972  
BMW 6 870 972

BMW 31 10 6 871 468  
BMW 6 871 468

**Application info**

BMW X3 (G01) (07/17--)  
BMW iX3 (09/20--)

BMW X4 (G02) (04/18--)

**Control arm**

316 050 0163

MCA1381

**Notes**

Aluminium  
Control Arm  
Front Axle Left  
Lower  
Rear  
outer

Paired article number 316 050 0164 | MCA1382  
Required quantity 1  
replacement in pairs recommended



**References**





BMW 31 10 6 861 173

BMW 6 861 173

**Application info**



BMW 5 (G30, G31) (09/16--)  
BMW 7 (G11, G12) (07/15--)

BMW 6 (G32) (06/17--)

Control arm		316 050 0164	MCA1382
<p><b>Notes</b></p> <p>Aluminium Control Arm Front Axle Right Lower Rear outer</p> <p>Paired article number Required quantity replacement in pairs recommended</p>		 	
<p><b>References</b></p> <p>BMW 31 10 6 861 174</p>		<p>BMW 6 861 174</p>	
<p><b>Application info</b></p> <p>BMW 5 (G30, G31) (09/16--) BMW 7 (G11, G12) (07/15--)</p>		<p>BMW 6 (G32) (06/17--)</p>	
Control arm		316 050 0165/HD	MCA1383HD
<p><b>Notes</b></p> <p>Aluminium Carbon Neutral Control Arm Front Front Axle Left Lower outer</p> <p>Paired article number Replace in pairs only Required quantity</p>		 	
<p><b>References</b></p> <p>BMW 31 10 6 861 157</p>		<p>BMW 6 861 157</p>	
<p><b>Application info</b></p> <p>BMW 5 (G30, G31) (09/16--) BMW 7 (G11, G12) (07/15--)</p>		<p>BMW 6 (G32) (06/17--)</p>	



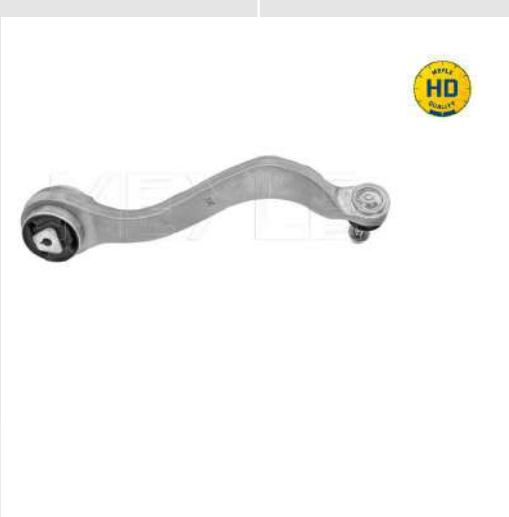

Control arm		316 050 0168	MCA1386
<p><b>Notes</b></p> <p>Aluminium Control Arm Front Axle Right Lower Rear</p> <p>Paired article number 316 050 0167   MCA1385 Required quantity 1 replacement in pairs recommended</p>			
<p><b>References</b></p> <p>BMW 31 10 6 861 182 BMW 6 861 182</p>			
<p><b>Application info</b></p> <p>BMW 5 (G30, G31) (09/16--)</p>			
Control arm		316 050 0169	MCA1372
<p><b>Notes</b></p> <p>Aluminium Control Arm Front Front Axle Left Lower outer</p> <p>Paired article number 316 050 0170   MCA1373 Required quantity 1 replacement in pairs recommended</p>			
<p><b>References</b></p> <p>BMW 31 10 6 861 165 BMW 6 861 165</p>			
<p><b>Application info</b></p> <p>BMW 5 (G30, G31) (09/16--)</p>			

Control arm		316 050 0170	MCA1373
<p><b>Notes</b></p> <p>Aluminium Control Arm Front Front Axle Right Lower outer</p> <p>Paired article number Required quantity replacement in pairs recommended</p>			
<p><b>References</b></p> <p>BMW 31 10 6 861 166</p>		<p>BMW 6 861 166</p>	
<p><b>Application info</b></p> <p>BMW 5 (G30, G31) (09/16--)</p>			
Control arm		316 050 0172/HD	MCA1471HD
<p><b>Notes</b></p> <p>Aluminium Carbon Neutral Control Arm Front Front Axle Right Lower with rubber mount</p> <p>Paired article number Replace in pairs only Required quantity reinforced version</p>			
<p><b>References</b></p> <p>BMW 31 10 6 879 544 BMW 31 10 6 894 662 BMW 6 879 544 BMW 6 894 662</p>		<p>BMW 31 10 6 879 850 BMW 31 10 6 894 676 BMW 6 879 850 BMW 6 894 676</p>	
<p><b>Application info</b></p> <p>BMW 3 (G20, G21) (11/18--)</p> <p>BMW 4 (G22, G23, G26) (07/20--)</p>			



<b>Control arm</b>	<b>316 050 0177</b>	<b>MCA1468</b>
--------------------	---------------------	----------------

**Notes**

Aluminium  
Control Arm  
Front Axle Left  
Lower  
Rear  
Paired article number 316 050 0176 | MCA1467  
Required quantity 1  
replacement in pairs recommended



**References**

BMW 31 10 6 878 081 BMW 6 878 081

**Application info**

BMW X5 (G05) (08/18--)  
BMW X7 (G07) (03/19--)  
BMW X6 (G06) (08/19--)  
BMW iX (I20) (07/21--)

<b>Control arm</b>	<b>316 050 0178/HD</b>	<b>MCA1508HD</b>
--------------------	------------------------	------------------

**Notes**

Aluminium  
Carbon Neutral  
Control Arm  
Front  
Front Axle Right  
Lower  
Paired article number 316 050 0179/HD | MCA1509HD  
Replace in pairs only  
Required quantity 1  
reinforced version



**References**

BMW 31 10 6 878 074 BMW 31 10 6 893 550  
BMW 6 878 074 BMW 6 893 550

**Application info**

BMW X5 (G05) (08/18--)  
BMW X7 (G07) (03/19--)  
BMW X6 (G06) (08/19--)  
BMW iX (I20) (07/21--)

## Control arm

316 050 0179/HD

MCA1509HD

## Notes

Aluminium  
Carbon Neutral  
Control Arm  
Front  
Front Axle Left  
Lower  
Paired article number  
316 050 0178/HD | MCA1508HD

Replace in pairs only  
Required quantity  
reinforced version

1



## References

BMW 31 10 6 878 073  
BMW 6 878 073

BMW 31 10 6 893 549  
BMW 6 893 549

## Application info

BMW X5 (G05) (08/18--)  
BMW X7 (G07) (03/19--)

BMW X6 (G06) (08/19--)  
BMW iX (I20) (07/21--)

## Control arm

316 050 0182

MCA1646

## Notes

Aluminium  
Control Arm  
Front Axle Left  
Front Axle Right  
Upper

Required quantity  
replacement in pairs recommended

2



## References

BMW 31 10 6 885 802

BMW 6 885 802

## Application info

BMW 5 (G30, G31) (09/16--)  
BMW 8 Gran Coupe (G16) (07/19--)

BMW 8 (G15) (07/18--)

Control arm		316 050 0183	MCA1444
<b>Notes</b>			
	Aluminium		
	Control Arm		
	Front		
	Front Axle Left		
	Lower		
Bore Diameter [mm]	14.2		
Length [mm]	397		
Paired article number	316 050 0184   MCA1445		
Required quantity	1		
Thread Size	M16x1,5		
replacement in pairs recommended			



<b>References</b>			
BMW 31 10 6 888 765		BMW 6 888 765	



<b>Application info</b>			
BMW 5 (G30, G31) (09/16--)		BMW 6 (G32) (06/17--)	

Control arm		316 050 0184	MCA1445
<b>Notes</b>			
	Aluminium		
	Control Arm		
	Front		
	Front Axle Right		
	Lower		
Bore Diameter [mm]	14.2		
Length [mm]	397		
Paired article number	316 050 0183   MCA1444		
Required quantity	1		
Thread Size	M16x1,5		
replacement in pairs recommended			

<b>References</b>			
BMW 31 10 6 888 766		BMW 6 888 766	

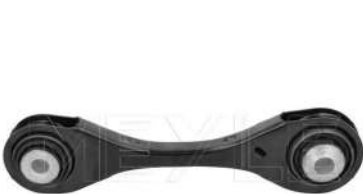

<b>Application info</b>			
BMW 5 (G30, G31) (09/16--)		BMW 6 (G32) (06/17--)	

Control arm		316 050 0185	MCA1631
<p><b>Notes</b></p> <p>Control Arm Rear Rear Axle Left Sheet Steel Upper</p> <p>Paired article number Required quantity replacement in pairs recommended</p>			
<p><b>References</b></p> <p>BMW 33 30 6 871 015</p>		<p>BMW 6 871 015</p>	
<p><b>Application info</b></p> <p>BMW X3 (G01) (07/17--)</p>		<p>BMW X4 (G02) (04/18--)</p>	
Control arm		316 050 0186	MCA1632
<p><b>Notes</b></p> <p>Control Arm Rear Rear Axle Right Sheet Steel Upper</p> <p>Paired article number Required quantity replacement in pairs recommended</p>			
<p><b>References</b></p> <p>BMW 33 30 6 871 016</p>		<p>BMW 6 871 016</p>	
<p><b>Application info</b></p> <p>BMW X3 (G01) (07/17--)</p>		<p>BMW X4 (G02) (04/18--)</p>	

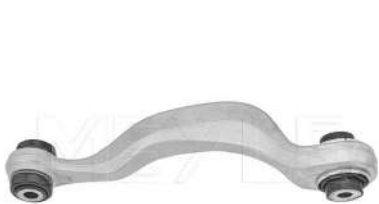
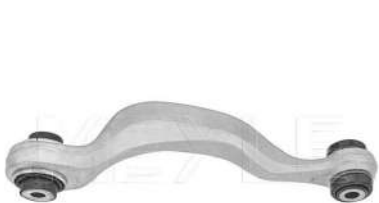

Control arm		316 050 0187	MCA1563
<p><b>Notes</b></p> <p>Control Arm Front Rear Axle Left Sheet Steel Upper</p> <p>Paired article number Required quantity replacement in pairs recommended</p>			
<p><b>References</b></p> <p>BMW 33 30 6 871 005</p>		<p>BMW 6 871 005</p>	
<p><b>Application info</b></p> <p>BMW X3 (G01) (07/17--)</p>		<p>BMW X4 (G02) (04/18--)</p>	
Control arm		316 050 0188	MCA1564
<p><b>Notes</b></p> <p>Control Arm Front Rear Axle Right Sheet Steel Upper</p> <p>Paired article number Required quantity replacement in pairs recommended</p>			
<p><b>References</b></p> <p>BMW 33 30 6 871 006</p>		<p>BMW 6 871 006</p>	
<p><b>Application info</b></p> <p>BMW X3 (G01) (07/17--)</p>		<p>BMW X4 (G02) (04/18--)</p>	



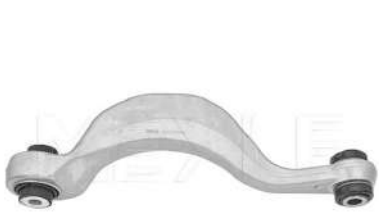
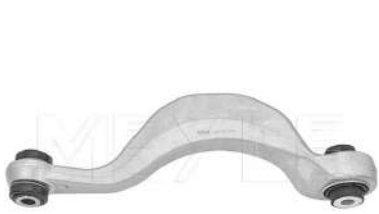

Control arm		316 050 0190	MCA1440
<p><b>Notes</b></p> <p>Aluminium Control Arm Rear Rear Axle Right Upper with rubber mount</p> <p>Length [mm] 296 Paired article number 316 050 0191   MCA1441 Required quantity 1 replacement in pairs recommended</p>			
<p><b>References</b></p> <p>BMW 33 30 6 871 012 BMW 6 871 012</p>			
<p><b>Application info</b></p> <p>BMW X3 (G01) (07/17--) BMW X4 (G02) (04/18--)</p>			
Control arm		316 050 0191	MCA1441
<p><b>Notes</b></p> <p>Aluminium Centre Control Arm Rear Rear Axle Left Upper with rubber mount</p> <p>Length [mm] 296 Paired article number 316 050 0190   MCA1440 Required quantity 1 replacement in pairs recommended</p>			
<p><b>References</b></p> <p>BMW 33 30 6 871 011 BMW 6 871 011</p>			
<p><b>Application info</b></p> <p>BMW X3 (G01) (07/17--) BMW X4 (G02) (04/18--)</p>			

Control arm		316 050 0194	MCA1633
<p><b>Notes</b></p> <p>Front Rear Axle Right Semi-Trailing Arm Sheet Steel Upper</p> <p>Paired article number 316 050 0195   MCA1634 Required quantity 1 replacement in pairs recommended</p>			
<p><b>References</b></p> <p>BMW 33 32 6 878 632 BMW 6 878 632</p>			
<p><b>Application info</b></p> <p>BMW 2 (G42) (08/21--) BMW 4 (G22, G23, G26) (07/20--) BMW i4 (G26) (11/21--)</p> <p>BMW 3 (G20, G21) (11/18--) BMW Z4 Roadster (G29) (11/18--)</p>			
Control arm		316 050 0195	MCA1634
<p><b>Notes</b></p> <p>Control Arm Front Rear Axle Left Sheet Steel Upper</p> <p>Paired article number 316 050 0194   MCA1633 Required quantity 1 replacement in pairs recommended</p>			
<p><b>References</b></p> <p>BMW 33 32 6 878 631 BMW 6 878 631 Toyota 48770-WAA01</p>			
<p><b>Application info</b></p> <p>BMW 2 (G42) (08/21--) BMW 4 (G22, G23, G26) (07/20--) BMW i4 (G26) (11/21--)</p> <p>BMW 3 (G20, G21) (11/18--) BMW Z4 Roadster (G29) (11/18--)</p>			

Control arm		316 050 0196	MCA1455
<p><b>Notes</b></p> <p>Aluminium Control Arm Rear Rear Axle Right Upper outer</p> <p>Paired article number Required quantity replacement in pairs recommended</p>			
<p><b>References</b></p> <p>BMW 33 30 6 878 022</p>		<p>BMW 6 878 022</p>	
<p><b>Application info</b></p> <p>BMW X5 (G05) (08/18--) BMW X7 (G07) (03/19--)</p>		<p>BMW X6 (G06) (08/19--)</p>	
Control arm		316 050 0197	MCA1456
<p><b>Notes</b></p> <p>Aluminium Control Arm Rear Rear Axle Left Upper outer</p> <p>Paired article number Required quantity replacement in pairs recommended</p>			
<p><b>References</b></p> <p>BMW 33 30 6 878 021</p>		<p>BMW 6 878 021</p>	
<p><b>Application info</b></p> <p>BMW X5 (G05) (08/18--) BMW X7 (G07) (03/19--)</p>		<p>BMW X6 (G06) (08/19--)</p>	

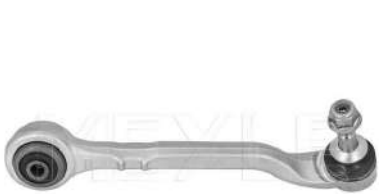
Control arm		316 050 0198	MCA1619
<p><b>Notes</b></p> <p>Centre Control Arm Rear Rear Axle Right Sheet Steel</p> <p>Paired article number 316 050 0199   MCA1620 Required quantity 1 replacement in pairs recommended</p>			
<p><b>References</b></p> <p>BMW 33 30 6 878 030 BMW 6 878 030</p>			
<p><b>Application info</b></p> <p>BMW X5 (G05) (08/18--) BMW X7 (G07) (03/19--)</p> <p>BMW X6 (G06) (08/19--)</p>			
Control arm		316 050 0199	MCA1620
<p><b>Notes</b></p> <p>Centre Control Arm Rear Rear Axle Left Sheet Steel</p> <p>Paired article number 316 050 0198   MCA1619 Required quantity 1 replacement in pairs recommended</p>			
<p><b>References</b></p> <p>BMW 33 30 6 878 029 BMW 6 878 029</p>			
<p><b>Application info</b></p> <p>BMW X5 (G05) (08/18--) BMW X7 (G07) (03/19--)</p> <p>BMW X6 (G06) (08/19--)</p>			

Control arm		316 050 0200	MCA1459
<p><b>Notes</b></p> <p>Aluminium Control Arm Front Axle Right Lower Rear</p> <p>Paired article number 316 050 0201   MCA1460 Required quantity 1 replacement in pairs recommended</p>			
<p><b>References</b></p> <p>BMW 31 12 6 854 728 BMW 6 854 728 BMW (Brilliance) 31 12 6 854 728 BMW (Brilliance) 6 854 728</p>			
<p><b>Application info</b></p> <p>BMW 1 (F20, F21) (07/11--) BMW 3 (F30, F31) (11/11-06/19) BMW 4 (F32, F33, F36) (07/13--)</p> <p>BMW 2 (F22,F23) (10/12--) BMW 3 (F34) (07/12--)</p>			
Control arm		316 050 0201	MCA1460
<p><b>Notes</b></p> <p>Aluminium Control Arm Front Axle Left Lower Rear</p> <p>Paired article number 316 050 0200   MCA1459 Required quantity 1 replacement in pairs recommended</p>			
<p><b>References</b></p> <p>BMW 31 12 6 854 727 BMW 6 854 727 BMW (Brilliance) 31 12 6 854 727 BMW (Brilliance) 6 854 727</p>			
<p><b>Application info</b></p> <p>BMW 1 (F20, F21) (07/11--) BMW 3 (F30, F31) (11/11-06/19) BMW 4 (F32, F33, F36) (07/13--)</p> <p>BMW 2 (F22,F23) (10/12--) BMW 3 (F34) (07/12--)</p>			

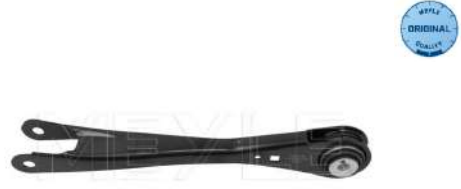
Control arm		316 050 0202	MCA1595
<b>Notes</b>  Control Arm Rear Axle Left Rear Axle Right Sheet Steel  Bore Diameter [mm] 12.1 Length [mm] 329.4 Required quantity 2 replacement in pairs recommended			
<b>References</b> BMW 33 30 6 878 639 BMW 6 878 639 Toyota 48711-WAA01			
<b>Application info</b> BMW 2 (G42) (08/21--) BMW 3 (G20, G21) (11/18--) BMW 4 (G22, G23, G26) (07/20--) BMW Z4 Roadster (G29) (11/18--) Toyota Supra V (_A9_) (03/19--)			
Control arm		316 050 0203	MCA1536
<b>Notes</b>  Control Arm Rear Axle Left Rear Axle Right Sheet Steel  Required quantity 2 replacement in pairs recommended			
<b>References</b> BMW 33 30 6 878 037 BMW 6 878 037			
<b>Application info</b> BMW X5 (G05) (08/18--) BMW X6 (G06) (08/19--) BMW X7 (G07) (03/19--) BMW XM (G09) (12/22--)			

**Control arm** **316 050 0204** **MCA1565**

<p><b>Notes</b></p> <p>Control Arm Rear Axle Left Rear Axle Right Sheet Steel Upper</p> <p>Required quantity 2 replacement in pairs recommended</p>	
---	---

<b>References</b>	
BMW 33 32 6 881 199	BMW 6 881 199
Toyota 48790 WAA01	



<b>Application info</b>	
BMW 2 (G42) (08/21--)	BMW 3 (G20, G21) (11/18--)
BMW 4 (G22, G23, G26) (07/20--)	BMW Z4 Roadster (G29) (11/18--)
Toyota Supra V (_A9_) (03/19--)	

**Control arm** **316 050 0261** **MCA1652**



<p><b>Notes</b></p> <p>Aluminium Control Arm Front Axle Left Lower Rear</p> <p>Paired article number 316 050 0262   MCA1653 Required quantity 1 replacement in pairs recommended</p>	
--	---

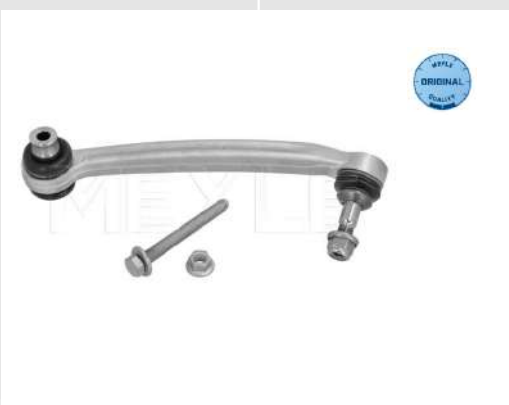

<b>References</b>	
BMW 2 283 577	BMW 31 10 2 283 577



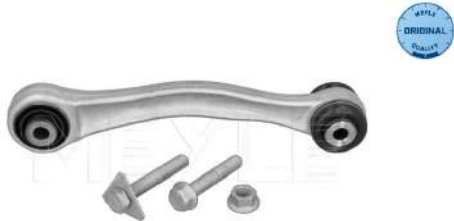

<b>Application info</b>	
BMW 1 (E81, E82, E87, E88) (02/03-12/13)	BMW 3 (E90, E91, E92, E93) (02/04-12/13)

Control arm		316 050 0262	MCA1653
<p><b>Notes</b></p> <p>Aluminium Control Arm Front Axle Right Lower Rear</p> <p>Paired article number 316 050 0261   MCA1652 Required quantity 1 replacement in pairs recommended</p>			
<p><b>References</b></p> <p>BMW 2 283 578 BMW 31 10 2 283 578</p>			
<p><b>Application info</b></p> <p>BMW 1 (E81, E82, E87, E88) (02/03-12/13) BMW 3 (E90, E91, E92, E93) (02/04-12/13)</p>			
Control arm		316 050 0263	MCA1656
<p><b>Notes</b></p> <p>Aluminium Control Arm Front Front Axle Left Lower</p> <p>Paired article number 316 050 0264   MCA1657 Required quantity 1 replacement in pairs recommended</p>			
<p><b>References</b></p> <p>BMW 2 283 575 BMW 31 10 2 283 575</p>			
<p><b>Application info</b></p> <p>BMW 1 (E81, E82, E87, E88) (02/03-12/13) BMW 3 (E90, E91, E92, E93) (02/04-12/13)</p>			



Control arm		316 050 0264	MCA1657
<b>Notes</b>  Aluminium Control Arm Front Front Axle Right Lower  Paired article number Required quantity replacement in pairs recommended			
<b>References</b> BMW 2 283 576		BMW 31 10 2 283 576	
<b>Application info</b> BMW 1 (E81, E82, E87, E88) (02/03-12/13)		BMW 3 (E90, E91, E92, E93) (02/04-12/13)	
Control arm		316 050 0265	MCA1640
<b>Notes</b>  Aluminium Control Arm Front Rear Axle Left Upper  Paired article number Required quantity replacement in pairs recommended			
<b>References</b> BMW 2 283 547		BMW 33 32 2 283 547	
<b>Application info</b> BMW 1 (E81, E82, E87, E88) (02/03-12/13)		BMW 3 (E90, E91, E92, E93) (02/04-12/13)	

Control arm		316 050 0266	MCA1641
<p><b>Notes</b></p> <p>Aluminium Control Arm Front Rear Axle Right Upper</p> <p>Paired article number Required quantity replacement in pairs recommended</p>			
<p><b>References</b></p> <p>BMW 2 283 548</p>		<p>BMW 33 32 2 283 548</p>	
<p><b>Application info</b></p> <p>BMW 1 (E81, E82, E87, E88) (02/03-12/13)</p>		<p>BMW 3 (E90, E91, E92, E93) (02/04-12/13)</p>	
Control arm		316 050 0267	MCA1642
<p><b>Notes</b></p> <p>Aluminium Centre Control Arm Rear Axle Left Upper</p> <p>Paired article number Required quantity replacement in pairs recommended</p>			
<p><b>References</b></p> <p>BMW 2 283 545</p>		<p>BMW 33 32 2 283 545</p>	
<p><b>Application info</b></p> <p>BMW 1 (E81, E82, E87, E88) (02/03-12/13)</p>		<p>BMW 3 (E90, E91, E92, E93) (02/04-12/13)</p>	

Control arm		316 050 0268	MCA1643
<p><b>Notes</b></p> <p>Aluminium Centre Control Arm Rear Axle Right Upper</p> <p>Paired article number Required quantity replacement in pairs recommended</p>		 	
<p><b>References</b></p> <p>BMW 2 283 546</p>		<p>BMW 33 32 2 283 546</p>	
<p><b>Application info</b></p> <p>BMW 1 (E81, E82, E87, E88) (02/03-12/13)</p>		<p>BMW 3 (E90, E91, E92, E93) (02/04-12/13)</p>	
Control arm		316 050 0269	MCA1660
<p><b>Notes</b></p> <p>Aluminium Control Arm Lower Rear Rear Axle Left Rear Axle Right</p> <p>Required quantity replacement in pairs recommended</p>		 	
<p><b>References</b></p> <p>BMW 2 283 549</p>		<p>BMW 33 32 2 283 549</p>	
<p><b>Application info</b></p> <p>BMW 1 (E81, E82, E87, E88) (02/03-12/13)</p>		<p>BMW 3 (E90, E91, E92, E93) (02/04-12/13)</p>	

**Control arm**

316 050 3601/HD

MCA0483HD

**Notes**

Carbon Neutral  
Control Arm  
Front Axle Right  
Steel  
with ball joint

Article number of recommended accessory 314 654 0009  
Paired article number 316 050 3602/HD | MCA0484HD  
Replace in pairs only  
Required quantity 1  
Thread Size 1 M12x1,5  
Thread Size 2 M14x1,5  
reinforced version



**References**

- |                     |                     |
|---------------------|---------------------|
| BMW 1 092 276       | BMW 1 136 530       |
| BMW 1 140 400       | BMW 1 140 958       |
| BMW 2 339 996       | BMW 31 12 1 092 276 |
| BMW 31 12 1 136 530 | BMW 31 12 1 140 400 |
| BMW 31 12 1 140 958 | BMW 31 12 2 339 996 |
| BMW 31 12 6 758 514 | BMW 31 12 6 758 516 |
| BMW 6 758 514       | BMW 6 758 516       |

**Application info**

BMW 3 (E36) (09/90-08/00)      BMW Z3 (E36/7, E36/8) (10/95-06/03)

**Control arm**

316 050 3602/HD

MCA0484HD

**Notes**

Carbon Neutral  
Control Arm  
Front Axle Left  
Steel  
with ball joint

Article number of recommended accessory 314 654 0009  
Paired article number 316 050 3601/HD | MCA0483HD  
Replace in pairs only  
Required quantity 1  
Thread Size 1 M12x1,5  
Thread Size 2 M14x1,5  
reinforced version



**References**

- |                     |                     |
|---------------------|---------------------|
| BMW 1 094 275       | BMW 1 136 529       |
| BMW 1 140 399       | BMW 1 140 957       |
| BMW 2 339 997       | BMW 31 12 1 094 275 |
| BMW 31 12 1 136 529 | BMW 31 12 1 140 399 |
| BMW 31 12 1 140 957 | BMW 31 12 2 339 997 |
| BMW 31 12 6 758 513 | BMW 31 12 6 758 515 |
| BMW 6 758 513       | BMW 6 758 515       |

**Application info**

- |                           |                                     |
|---------------------------|-------------------------------------|
| BMW 3 (E36) (09/90-08/00) | BMW Z3 (E36/7, E36/8) (10/95-06/03) |
|---------------------------|-------------------------------------|

**Control arm**

316 050 3807

MCA0485

**Notes**

Control Arm  
Rear Axle Left  
Sheet Steel  
Upper  
with ball joint  
with rubber mount

- |                                  |                        |
|----------------------------------|------------------------|
| Length [mm]                      | 306                    |
| Paired article number            | 316 050 3808   MCA0486 |
| Required quantity                | 1                      |
| Thread Size                      | M14x1,5                |
| replacement in pairs recommended |                        |



**References**

- |                     |                     |
|---------------------|---------------------|
| BMW 1 090 905       | BMW 33 32 1 090 905 |
| BMW 33 32 6 770 059 | BMW 6 770 059       |

**Application info**

- |                           |                            |
|---------------------------|----------------------------|
| BMW 7 (E38) (03/94-11/01) | BMW Z8 (E52) (01/00-12/03) |
|---------------------------|----------------------------|

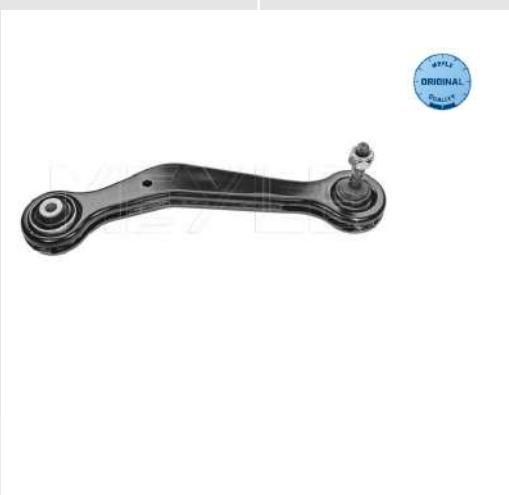
Control arm		316 050 3808	MCA0486
<b>Notes</b>	Control Arm Rear Axle Right Sheet Steel Upper with ball joint with rubber mount		
Length [mm]	306		
Paired article number	316 050 3807   MCA0485		
Required quantity	1		
Thread Size	M14x1,5		
replacement in pairs recommended			





References	
BMW 1 090 906	BMW 33 32 1 090 906
BMW 33 32 6 770 060	BMW 6 770 060

Application info	
BMW 7 (E38) (03/94-11/01)	BMW Z8 (E52) (01/00-12/03)

Control arm		316 050 3901	MCA0487
<b>Notes</b>	Aluminium Control Arm Front Axle Left Rear with rubber mount		
Length [mm]	314		
Paired article number	316 050 3902   MCA0488		
Required quantity	1		
Thread Size	M14x1,5		
replacement in pairs recommended			

References	
BMW 1 093 449	BMW 1 094 233
BMW 2 157 597	BMW 2 341 219
BMW 31 12 1 093 449	BMW 31 12 1 094 233
BMW 31 12 2 157 597	BMW 31 12 2 341 219
BMW 31 12 9 069 568	BMW 9 069 568

Application info	
BMW 5 (E39) (09/95-06/04)	

Control arm		316 050 3902	MCA0488
<b>Notes</b>  Aluminium Control Arm Front Axle Right Rear with rubber mount  Length [mm] 314 Paired article number 316 050 3901   MCA0487 Required quantity 1 Thread Size M14x1,5 replacement in pairs recommended		 	
<b>References</b> BMW 1 093 450 BMW 1 094 234 BMW 2 157 597 BMW 2 341 296 BMW 31 12 1 093 450 BMW 31 12 1 094 234 BMW 31 12 2 157 597 BMW 31 12 2 341 296 BMW 31 12 9 069 568 BMW 9 069 568			
<b>Application info</b> BMW 5 (E39) (09/95-06/04)			
Control arm		316 050 3903/HD	MCA0489HD
<b>Notes</b>  Aluminium Carbon Neutral Control Arm Front Front Axle Left with rubber mount  Length [mm] 428 Paired article number 316 050 3904/HD   MCA0490HD Replace in pairs only Required quantity 1 Thread Size M14x1,5 reinforced version		 	
<b>References</b> BMW 1 092 023 BMW 1 141 717 BMW 31 12 1 092 023 BMW 31 12 1 141 717			

**Application info**

BMW 5 (E39) (09/95-06/04)

BMW Z8 (E52) (01/00-12/03)

**Control arm****316 050 3904/HD****MCA0490HD****Notes**

Aluminium  
Carbon Neutral  
Control Arm  
Front  
Front Axle Right  
with rubber mount

Length [mm]

428

Paired article number

316 050 3903/HD | MCA0489HD

Replace in pairs only

Required quantity

1

Thread Size

M14x1,5

reinforced version

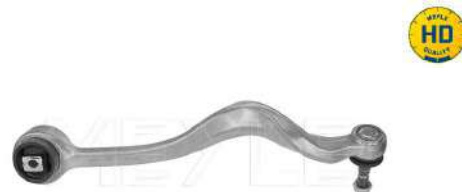
**References**

BMW 1 092 024

BMW 1 141 718

BMW 31 12 1 092 024

BMW 31 12 1 141 718

**Application info**

BMW 5 (E39) (09/95-06/04)

BMW Z8 (E52) (01/00-12/03)

**Control arm****316 050 4206****MCA0494****Notes**

Control Arm  
Front Axle Left  
Lower  
Steel  
with rubber mount

Length [mm]

294

Paired article number

316 050 4207 | MCA0495

Required quantity

1

Thread Size

M12x1,5

replacement in pairs recommended

**References**



BMW 1 123 025

BMW 31 12 1 123 025

**Application info**

BMW 3 (E21) (06/75-03/84)



Control arm		316 050 4207	MCA0495
<b>Notes</b>  Control Arm Front Axle Right Lower Steel with rubber mount  Length [mm] 294 Paired article number 316 050 4206   MCA0494 Required quantity 1 Thread Size M12x1,5 replacement in pairs recommended			
<b>References</b> BMW 1 123 026 BMW 1 123 027 BMW 31 12 1 123 026 BMW 31 12 1 123 027			
<b>Application info</b> BMW 3 (E21) (06/75-03/84)			
Control arm		316 050 4217	MCA0496
<b>Notes</b>  Control Arm Front Front Axle Left Steel with rubber mount  Length [mm] 325 Paired article number 316 050 4218   MCA0497 Required quantity 1 Thread Size M14x1,5 replacement in pairs recommended			
<b>References</b> BMW 1 124 401 BMW 1 131 587 BMW 1 139 991 BMW 31 12 1 124 401 BMW 31 12 1 131 587 BMW 31 12 1 139 991			
<b>Application info</b> BMW 5 (E28) (05/81-12/87) BMW 5 (E34) (02/87-07/96) BMW 6 (E24) (10/75-04/89) BMW 7 (E32) (03/85-10/94)			

**Control arm** **316 050 4218** **MCA0497**

**Notes**

Control Arm  
 Front  
 Front Axle Right  
 Steel  
 with rubber mount  
 Length [mm] 325  
 Paired article number 316 050 4217 | MCA0496  
 Required quantity 1  
 Thread Size M14x1,5  
 replacement in pairs recommended



**References**

- |                     |                     |
|---------------------|---------------------|
| BMW 1 124 402       | BMW 1 131 582       |
| BMW 1 131 588       | BMW 1 139 992       |
| BMW 31 12 1 124 402 | BMW 31 12 1 131 582 |
| BMW 31 12 1 131 588 | BMW 31 12 1 139 992 |

**Application info**

- |                           |                           |
|---------------------------|---------------------------|
| BMW 5 (E28) (05/81-12/87) | BMW 5 (E34) (02/87-07/96) |
| BMW 6 (E24) (10/75-04/89) | BMW 7 (E32) (03/85-10/94) |

**Control arm** **316 050 4317/HD** **MCA0500HD**

**Notes**

Carbon Neutral  
 Control Arm  
 Front Axle Left  
 Rear  
 Steel  
 with rubber mount  
 Article number of recommended accessories 316 654 0015  
 Length [mm] 414  
 Paired article number 316 050 4318/HD | MCA0501HD  
 Replace in pairs only  
 Required quantity 1  
 Thread Size M14x1,5  
 reinforced version



**References**

- |                     |                     |
|---------------------|---------------------|
| BMW 1 130 089       | BMW 1 130 597       |
| BMW 1 139 999       | BMW 31 12 1 130 089 |
| BMW 31 12 1 130 597 | BMW 31 12 1 139 999 |

**Application info**

BMW 7 (E32) (03/85-10/94)

BMW 8 (E31) (01/90-12/99)

**Control arm**

316 050 4318/HD

MCA0501HD

**Notes**

Carbon Neutral  
Control Arm  
Front Axle Right  
Rear  
Steel  
with rubber mount



Article number of recommended accessories 314 654 0015  
Length [mm] 414  
Paired article number 316 050 4317/HD | MCA0500HD  
Replace in pairs only  
Required quantity 1  
Thread Size M14x1,5  
reinforced version

**References**

BMW 1 130 090

BMW 1 130 598

BMW 1 133 490

BMW 1 140 000

BMW 31 12 1 130 090

BMW 31 12 1 130 598

BMW 31 12 1 133 490

BMW 31 12 1 140 000

**Application info**

BMW 7 (E32) (03/85-10/94)

BMW 8 (E31) (01/90-12/99)

**Control arm**

316 050 4332/HD

MCA0502HD

**Notes**

Carbon Neutral  
Control Arm  
Front Axle Left  
Rear  
Steel  
with rubber mount



Article number of recommended accessories 314 654 0016  
Length [mm] 388  
Paired article number 316 050 4333/HD | MCA0503HD  
Replace in pairs only  
Required quantity 1  
Thread Size M14x1,5  
reinforced version

**References**

BMW 1 132 159	BMW 1 133 711
BMW 1 141 097	BMW 31 12 1 132 159
BMW 31 12 1 133 711	BMW 31 12 1 141 097

**Application info**

BMW 5 (E34) (02/87-07/96)

**Control arm**

316 050 4333/HD

MCA0503HD

**Notes**

Carbon Neutral  
Control Arm  
Front Axle Right  
Rear  
Steel  
with rubber mount



Article number of recommended accessories	314 654 0016
Length [mm]	388
Paired article number	316 050 4332/HD   MCA0502HD
Replace in pairs only	
Required quantity	1
Thread Size	M14x1,5
reinforced version	

**References**

BMW 1 132 160	BMW 1 133 712
BMW 1 141 098	BMW 31 12 1 132 160
BMW 31 12 1 133 712	BMW 31 12 1 141 098

**Application info**

BMW 5 (E34) (02/87-07/96)

**Control arm****316 050 4360****MCA0504****Notes**

Aluminium  
Control Arm  
Front  
Front Axle Right  
with rubber mount

Length [mm]

323

Paired article number

316 050 4361 | MCA0505

Required quantity

1

Thread Size

M14x1,5

replacement in pairs recommended

**References**

BMW 1 142 088

BMW 31 12 1 142 088

**Application info**

BMW 7 (E38) (03/94-11/01)

**Control arm****316 050 4361****MCA0505****Notes**

Aluminium  
Control Arm  
Front  
Front Axle Left  
with rubber mount

Length [mm]

323

Paired article number

316 050 4360 | MCA0504

Required quantity

1

Thread Size

M14x1,5

replacement in pairs recommended

**References**

BMW 1 142 087

BMW 31 12 1 142 087

**Application info**

BMW 7 (E38) (03/94-11/01)

**Control arm**

316 050 4362/HD

MCA0506HD

**Notes**

Carbon Neutral  
Control Arm  
Front Axle Right  
Rear  
Steel  
with rubber mount

Article number of recommended accessories 314 654 0017  
Length [mm] 438  
Paired article number 316 050 4363/HD | MCA0507HD  
Replace in pairs only  
Required quantity 1  
Thread Size M14x1,5  
reinforced version  
replacement in pairs recommended



**References**

BMW 1 141 722 BMW 1 141 724  
BMW 31 12 1 141 722 BMW 31 12 1 141 724

**Application info**

BMW 7 (E38) (03/94-11/01)

**Control arm**

316 050 4363/HD

MCA0507HD

**Notes**

Carbon Neutral  
Control Arm  
Front Axle Left  
Rear  
Steel  
with rubber mount

Article number of recommended accessories 314 654 0017  
Length [mm] 438  
Paired article number 316 050 4362/HD | MCA0506HD  
Replace in pairs only  
Required quantity 1  
Thread Size M14x1,5  
reinforced version



**References**

BMW 1 141 721 BMW 1 141 723  
BMW 31 12 1 141 721 BMW 31 12 1 141 723

**Application info**

BMW 7 (E38) (03/94-11/01)

**Control arm**

316 050 4366

MCA0508

**Notes**

Control Arm  
Front Axle Right  
Steel  
with ball joint

Paired article number 316 050 4367 | MCA0509  
Required quantity 1  
Thread Size 1 M14x1,5  
Thread Size 2 M12x1,5  
replacement in pairs recommended



**References**

BMW 1 127 726

BMW 31 12 1 127 726

**Application info**

BMW 3 (E30) (09/82-10/94)

BMW Z1 (06/88-06/91)

**Control arm**

316 050 4367

MCA0509

**Notes**

Control Arm  
Front Axle Left  
Steel  
with ball joint

Paired article number 316 050 4366 | MCA0508  
Required quantity 1  
Thread Size 1 M14x1,5  
Thread Size 2 M12x1,5  
replacement in pairs recommended



**References**



BMW 1 127 725

BMW 31 12 1 127 725

**Application info**

BMW 3 (E30) (09/82-10/94)

BMW Z1 (06/88-06/91)

Control arm		316 050 4370	MCA0510
<b>Notes</b>  Aluminium Control Arm Front Front Axle Right with rubber mount  Length [mm] 325 Paired article number 316 050 4371   MCA0511 Required quantity 1 Thread Size M14x1,5 replacement in pairs recommended			
<b>References</b> BMW 1 133 238 BMW 1 139 988 BMW 31 12 1 133 238 BMW 31 12 1 139 988 BMW 32 21 1 139 988			
<b>Application info</b> BMW 5 (E34) (02/87-07/96) BMW 7 (E32) (03/85-10/94)			
Control arm		316 050 4371	MCA0511
<b>Notes</b>  Aluminium Control Arm Front Front Axle Left with rubber mount  Length [mm] 325 Paired article number 316 050 4370   MCA0510 Required quantity 1 Thread Size M14x1,5 replacement in pairs recommended			
<b>References</b> BMW 1 133 237 BMW 1 139 987 BMW 31 12 1 133 237 BMW 31 12 1 139 987 BMW 32 21 1 139 987			
<b>Application info</b> BMW 5 (E34) (02/87-07/96) BMW 7 (E32) (03/85-10/94)			



**Control arm****316 333 2101****MCA0512****Notes**

Control Arm  
Lower  
Rear Axle Left  
Rear Axle Right  
Sheet Steel  
with rubber mount

Required quantity  
replacement in pairs recommended

2

**References**

BMW 1 090 030  
BMW 33 32 1 090 030  
BMW 33 32 6 770 749

BMW 1 091 620  
BMW 33 32 1 091 620  
BMW 6 770 749

**Application info**

BMW 5 (E39) (09/95-06/04)  
BMW 6 (E63, E64) (09/03-12/10)  
BMW 7 (E65, E66) (07/01-12/09)  
BMW Z8 (E52) (01/00-12/03)

BMW 5 (E60, E61) (12/01-12/10)  
BMW 7 (E38) (03/94-11/01)  
BMW X5 (E53) (01/00-12/06)

**Control arm****32-16 050 0087****MCA1332****Notes**

Control Arm  
Rear Axle Left  
Rear Axle Right  
Steel  
Upper  
outer

Required quantity  
replacement in pairs recommended

2

**References**



Citroën 16 074 983 80  
Peugeot 16 07 498 380

Mitsubishi MN184100

**Application info**

Citroën C4 AIRCROSS (08/10--)  
Mitsubishi Lancer VII (03/00-12/13)  
Mitsubishi Outlander II (11/06-12/12)  
Peugeot 4008 (05/12--)

Mitsubishi ASX I (11/09--)  
Mitsubishi Lancer VIII (03/07--)  
Mitsubishi Outlander III (11/10--)

Control arm		32-16 050 0088	MCA1517
<b>Notes</b>  Control Arm Lower Rear Axle Left Rear Axle Right Sheet Steel  Required quantity replacement in pairs recommended			
<b>References</b> Mitsubishi 4113A125 Mitsubishi 4113A135 Mitsubishi 4113A136			
<b>Application info</b> Mitsubishi ASX I (11/09--) Mitsubishi Outlander III (11/10--)			
Control arm		32-16 050 0092/HD	MCA1540HD
<b>Notes</b>  Carbon Neutral Control Arm Front Axle Right Lower Sheet Steel with ball joint with rubber mount  Paired article number Replace in pairs only Required quantity reinforced version			
Paired article number Replace in pairs only Required quantity reinforced version		32-16 050 0093/HD   MCA1541HD  1	
<b>References</b> Citroën 16 124 484 80 Citroën 3521.R1 Citroën 3521.V0 Mitsubishi 4013A010 Mitsubishi 4013A218 Mitsubishi 4013A280 Mitsubishi 4013A282 Mitsubishi 4013A428 Mitsubishi 4013A430 Peugeot 16 124 484 80 Peugeot 3521 R1 Peugeot 3521.V0			

**Application info**

Citroën C-Crosser (02/07--)  
 Mitsubishi ASX I (11/09--)  
 Mitsubishi Lancer VIII (03/07--)  
 Mitsubishi Outlander III (11/10--)  
 Peugeot 4008 (05/12--)

Citroën C4 AIRCROSS (08/10--)  
 Mitsubishi Lancer VII (03/00-12/13)  
 Mitsubishi Outlander II (11/06-12/12)  
 Peugeot 4007 (02/07-03/13)

**Control arm****32-16 050 0093/HD****MCA1541HD****Notes**

Carbon Neutral  
 Control Arm  
 Front Axle Left  
 Lower  
 Sheet Steel  
 with ball joint  
 with rubber mount

Paired article number  
 Replace in pairs only  
 Required quantity  
 reinforced version

32-16 050 0092/HD | MCA1540HD

1

**References**

Citroën 16 124 483 80  
 Citroën 3520.X9  
 Mitsubishi 4013A217  
 Mitsubishi 4013A281  
 Mitsubishi 4013A429  
 Peugeot 3520.V0

Citroën 3520.V0  
 Mitsubishi 4013A009  
 Mitsubishi 4013A279  
 Mitsubishi 4013A427  
 Peugeot 16 124 483 80  
 Peugeot 3520.X9

**Application info**

Citroën C-Crosser (02/07--)  
 Mitsubishi ASX I (11/09--)  
 Mitsubishi Lancer VIII (03/07--)  
 Mitsubishi Outlander III (11/10--)  
 Peugeot 4008 (05/12--)

Citroën C4 AIRCROSS (08/10--)  
 Mitsubishi Lancer VII (03/00-12/13)  
 Mitsubishi Outlander II (11/06-12/12)  
 Peugeot 4007 (02/07-03/13)

**Control arm**

33-16 050 0006

MCA0546

**Notes**

Control Arm  
Front Axle Right  
Lower  
Sheet Steel  
with ball joint  
with rubber mount

Paired article number 33-16 050 0007 | MCA0547  
Required quantity 1  
replacement in pairs recommended



**References**

Fiat 71742731	Fiat 71750149
Fiat 71768163	Suzuki 45201-54L00
Suzuki 45201-54L20	Suzuki 45201-79J00
Suzuki 45201-79J00-000	

**Application info**

Fiat Sedici (06/06-10/14)	Suzuki SX4 (06/06--)
---------------------------	----------------------

**Control arm**

33-16 050 0007

MCA0547

**Notes**

Control Arm  
Front Axle Left  
Lower  
Sheet Steel  
with ball joint  
with rubber mount

Paired article number 33-16 050 0006 | MCA0546  
Required quantity 1  
replacement in pairs recommended







**References**

Fiat 71742732	Fiat 71750211
Fiat 71768151	Suzuki 45202-54L00
Suzuki 45202-54L20	Suzuki 45202-79J00
Suzuki 45202-79J00-000	

**Application info**

Fiat Sedici (06/06-10/14)	Suzuki SX4 (06/06--)
---------------------------	----------------------

Control arm		34-16 050 0026	MCA1518
<b>Notes</b>			
	Control Arm Front Lower Rear Axle Left Rear Axle Right Steel Pipe		
Required quantity replacement in pairs recommended	2		
<b>References</b>			
Subaru 20250FG020		Subaru 20250FG021	
<b>Application info</b>			
Subaru BRZ (06/12--)		Subaru Forester III (SH) (12/07--)	
Subaru Forester IV (SJ) (11/12--)		Subaru Impreza III (GR) (01/07--)	
Subaru Impreza IV (GP, GJ) (07/11--)		Subaru Legacy V (06/08--)	
Subaru Legacy VI (BN, BS) (01/15--)		Subaru Outback IV (BM, BR) (06/09--)	
Subaru XV I (09/11--)			
Control arm		35-16 050 0060/HD	MCA0578HD
<b>Notes</b>			
	Carbon Neutral Control Arm Front Axle Right Lower Sheet Steel with ball joint with rubber mount		
Paired article number Replace in pairs only Required quantity	35-16 050 0061/HD   MCA0579HD  1		

**References**

Mazda B32H-34 300	Mazda B32H-34-300A
Mazda B32H-34-300B	Mazda B32H-34-300C
Mazda B32H-34-300D	Mazda B32H-34-300E
Mazda B37F-34-300A	Mazda B37F-34-300B
Mazda BP4K-34 300A	Mazda BP4K-34 300B
Mazda BP4K-34-300D	Mazda C513-34-300
Mazda CC30-34 300A	Mazda CC30-34 300B
Mazda CC30-34 300C	Mazda CC30-34 300D
Mazda CC30-34 300E	Mazda CD99-34-300A

**Application info**

Mazda 3 (BK) (09/99-12/09)	Mazda 5 (CR) (02/05-12/10)
Mazda 5 (CW) (06/10--)	

**Control arm**

35-16 050 0061/HD

MCA0579HD

**Notes**

Carbon Neutral  
Control Arm  
Front Axle Left  
Lower  
Sheet Steel  
with ball joint  
with rubber mount



Paired article number 35-16 050 0060/HD | MCA0578HD

Replace in pairs only



Required quantity 1

**References**

Mazda B32H-34 350	Mazda B32H-34 350E
Mazda B32H-34-350A	Mazda B32H-34-350B
Mazda B32H-34-350C	Mazda B32H-34-350D
Mazda B37F-34-350A	Mazda B37F-34-350B
Mazda BP4K-34 350A	Mazda BP4K-34 350B
Mazda BP4K-34-350C	Mazda BP4K-34-350D
Mazda BP4K-34-350E	Mazda C513-34-350
Mazda CC30-34 350A	Mazda CC30-34 350B
Mazda CC30-34 350C	Mazda CC30-34 350D
Mazda CC30-34 350E	Mazda CD99-34-350A

**Application info**

Mazda 3 (BK) (09/99-12/09)	Mazda 5 (CR) (02/05-12/10)
Mazda 5 (CW) (06/10--)	

Control arm		35-16 050 0099	MCA1387
<p><b>Notes</b></p> <p>Control Arm Front Axle Left Lower Sheet Steel</p> <p>Paired article number 35-16 050 0100   MCA1388</p> <p>Required quantity 1</p> <p>replacement in pairs recommended</p>			
<p><b>References</b></p> <p>Mazda D10E-34-350 Mazda D10E-34-350A</p> <p>Mazda D10E-34-350B</p>			
<p><b>Application info</b></p> <p>Mazda CX-3 (DK) (01/15--)</p>			
Control arm		35-16 050 0100	MCA1388
<p><b>Notes</b></p> <p>Control Arm Front Axle Right Lower Sheet Steel</p> <p>Paired article number 35-16 050 0099   MCA1387</p> <p>Required quantity 1</p> <p>replacement in pairs recommended</p>			
<p><b>References</b></p> <p>Mazda D10E-34-300 Mazda D10E-34-300A</p> <p>Mazda D10E-34-300B</p>			
<p><b>Application info</b></p> <p>Mazda CX-3 (DK) (01/15--)</p>			

DRIVER'S BEST FRIEND

MEYLE

**Control arm**

35-16 050 0101

MCA1409

**Notes**

Front  
Lower  
Rear Axle Left  
Rear Axle Right  
Sheet Steel  
Trailing Arm

Required quantity  
replacement in pairs recommended



**References**

Mazda KD35-28-500

**Application info**

Mazda CX-5 I (KE) (11/11-02/17)

**Control arm**

36-16 050 0007/HD

MCA0586HD

**Notes**

Carbon Neutral  
Control Arm  
Front Axle Left  
Sheet Steel  
with ball joint  
with rubber mount

Paired article number  
Replace in pairs only  
Required quantity  
reinforced version

36-16 050 0008/HD | MCA0587HD



**References**

Nissan 54501-BB00A  
Nissan 54501-JD000  
Nissan 54501-JG00A  
Renault 54501JY00A



Nissan 54501-BR30A  
Nissan 54501-JG000  
Nissan 54501-JG00B  
Renault 545055212R



**Application info**



Nissan Qashqai I (J10\_) (12/06-04/14)  
Renault Koleos I (09/08--)



Nissan X-Trail (T31) (03/07-12/18)







Control arm		36-16 050 0008/HD	MCA0587HD
<b>Notes</b>  Carbon Neutral Control Arm Front Axle Right Sheet Steel with ball joint with rubber mount  Paired article number Replace in pairs only Required quantity reinforced version			
<b>References</b> Nissan 54500-BB00A Nissan 54500-JD000 Nissan 54500-JG00A Renault 54500JY00A		Nissan 54500-BR30A Nissan 54500-JG000 Nissan 54500-JG00B Renault 545040445R	
<b>Application info</b> Nissan Qashqai I (J10_) (12/06-04/14) Renault Koleos I (09/08-- )		Nissan X-Trail (T31) (03/07-12/18)	
Control arm		36-16 050 0045	MCA0595
<b>Notes</b>  Control Arm Front Axle Left Lower Sheet Steel with ball joint with rubber mount  Paired article number Required quantity Thread Size replacement in pairs recommended			
<b>References</b> Nissan 54501-44B00 Nissan 54501-4F105		Nissan 54501-4F102 Nissan 54501-4F150	
<b>Application info</b> Nissan Micra (K11) (01/92-12/07)			

Control arm		36-16 050 0046	MCA0596
<p><b>Notes</b></p> <p>Control Arm Front Axle Right Lower Sheet Steel with ball joint with rubber mount</p> <p>Paired article number 36-16 050 0045   MCA0595 Required quantity 1 Thread Size M12x1,25 replacement in pairs recommended</p>			
<p><b>References</b></p> <p>Nissan 54500-44B00 Nissan 54500-4F102 Nissan 54500-4F105 Nissan 54500-4F150</p>			
<p><b>Application info</b></p> <p>Nissan Micra (K11) (01/92-12/07)</p>			
Control arm		36-16 050 0059/HD	MCA0806HD
<p><b>Notes</b></p> <p>Carbon Neutral Control Arm Front Axle Left Sheet Steel for left-hand drive vehicles for right-hand drive vehicles with ball joint with rubber mount</p> <p>Paired article number 36-16 050 0060/HD   MCA0807HD Replace in pairs only Required quantity 1 reinforced version</p>			
<p><b>References</b></p> <p>Nissan 54501-1KA0A Nissan 54501-1KA0B Nissan 54501-1KA1B Nissan 54501-1KK0A Nissan 54501-5SN1A Nissan 54501-BA60A</p>			
<p><b>Application info</b></p> <p>Nissan Juke (F15) (06/10--) Nissan Leaf I (ZE0) (11/10--)</p>			

Control arm		36-16 050 0060/HD	MCA0807HD
<p><b>Notes</b></p> <p>Carbon Neutral Control Arm Front Axle Right Sheet Steel for left-hand drive vehicles for right-hand drive vehicles with ball joint with rubber mount</p> <p>Paired article number Replace in pairs only Required quantity reinforced version</p>		 <p>MEYLE HD Product</p>	
<p>36-16 050 0059/HD   MCA0806HD</p> <p>1</p>			
<p><b>References</b></p> <p>Nissan 54500-1KA0A Nissan 54500-1KA0B Nissan 54500-1KA1B Nissan 54500-1KK0A Nissan 54500-5SN1A Nissan 54500-BA60A</p>			
<p><b>Application info</b></p> <p>Nissan Juke (F15) (06/10--)</p> <p>Nissan Leaf I (ZE0) (11/10--)</p>			
Control arm		36-16 050 0093	MCA1163
<p><b>Notes</b></p> <p>Control Arm Front Axle Right Sheet Steel with ball joint with rubber mount</p> <p>Paired article number Required quantity replacement in pairs recommended</p>		 <p>MEYLE ORIGINAL Product</p>	
<p>36-16 050 0094   MCA1164</p> <p>1</p>			
<p><b>References</b></p> <p>Nissan 54500-1HA0C Nissan 54500-1HA5A Nissan 54500-1HA5D Nissan 54500-1HA6A Nissan 54500-1HA7A Nissan 545003VU0A</p>			
<p><b>Application info</b></p> <p>Nissan Micra (K13) (05/10--)</p> <p>Nissan Note II (09/12--)</p>			

Control arm		36-16 050 0094	MCA1164
<b>Notes</b>  Control Arm Front Axle Left Sheet Steel with ball joint with rubber mount  Paired article number Required quantity replacement in pairs recommended			
<b>References</b> Nissan 54501-1HA0C Nissan 54501-1HA5D Nissan 54501-1HA7A		Nissan 54501-1HA5A Nissan 54501-1HA6A Nissan 545013VU0A	
<b>Application info</b> Nissan Micra (K13) (05/10--)		Nissan Note II (09/12--)	
Control arm		36-16 050 0098	MCA1178
<b>Notes</b>  Control Arm Front Axle Right Lower Sheet Steel outer  Paired article number Required quantity replacement in pairs recommended			
<b>References</b> Nissan 54500-4EA0B		Renault 545004EA0B	
<b>Application info</b> Nissan Qashqai II (J11_) (11/13--)		Renault Kadjar (06/15--)	

Control arm		36-16 050 0099	MCA1179
<p><b>Notes</b></p> <p>Control Arm Front Axle Left Lower Sheet Steel outer</p> <p>Paired article number 36-16 050 0098   MCA1178 Required quantity 1 replacement in pairs recommended</p>			
<p><b>References</b></p> <p>Nissan 54501-4EA0B Renault 545014EA0B</p>			
<p><b>Application info</b></p> <p>Nissan Qashqai II (J11_) (11/13--) Renault Kadjar (06/15--)</p>			
Control arm		37-16 050 0069	MCA1290
<p><b>Notes</b></p> <p>Control Arm Front Axle Left Lower Sheet Steel</p> <p>Paired article number 37-16 050 0070   MCA1291 Required quantity 1 replacement in pairs recommended</p>			
<p><b>References</b></p> <p>Hyundai 54500-J9000</p>			
<p><b>Application info</b></p> <p>Hyundai Kona I (06/17--)</p>			

Control arm		37-16 050 0070	MCA1291
<b>Notes</b>  Control Arm Front Axle Right Lower Sheet Steel  Paired article number 37-16 050 0069   MCA1290 Required quantity 1 replacement in pairs recommended			
<b>References</b> Hyundai 54501-J9000			
<b>Application info</b> Hyundai Kona I (06/17--)			
Control arm		37-16 050 0083/HD	MCA1524HD
<b>Notes</b>  Carbon Neutral Control Arm Front Axle Left Lower Sheet Steel for left-hand drive vehicles for right-hand drive vehicles  Length [mm] 348 Paired article number 37-16 050 0084/HD   MCA1525HD Replace in pairs only Required quantity 1 Width [mm] 298.7 reinforced version			
<b>References</b> Kia 54500-H8000			
<b>Application info</b> Kia Rio IV (01/17--)			

**Control arm** 37-16 050 0084/HD MCA1525HD**Notes**

Carbon Neutral  
Control Arm  
Front Axle Right  
Lower  
Sheet Steel  
for left-hand drive vehicles  
for right-hand drive vehicles

Length [mm] 348  
Paired article number 37-16 050 0083  
Paired article number 37-16 050 0083/HD | MCA1524HD  
Replace in pairs only  
Required quantity 1  
Width [mm] 298.7

**References**

Kia 54501 H8000

**Application info**

Kia Rio IV (01/17--)

**Control arm** 37-16 050 0087 MCA1311**Notes**

Rear Axle Left  
Rear Axle Right  
Sheet Steel  
Trailing Arm  
Upper  
outer

Required quantity 2  
replacement in pairs recommended

**References**





Hyundai 55100-D3050

Kia 55100 D3050

**Application info**

Hyundai Tucson II (05/15--)

Kia Sportage IV (09/15--)

Control arm		37-16 050 0098	MCA1408
<b>Notes</b>  Control Arm Rear Rear Axle Left Rear Axle Right Sheet Steel Upper outer  Required quantity replacement in pairs recommended		 	
<b>References</b> Hyundai 55100-2S050 Kia 55100 2S050		Hyundai 55100-3R050 Kia 55100 3R050	
<b>Application info</b> Hyundai Grandeur V (01/11--) Hyundai Sonata VI (06/09-12/15) Hyundai ix35 (08/09--) Kia Sorento II (06/09--)		Hyundai Santa Fé III (09/12--) Hyundai Tucson I (06/04--) Kia Optima (01/10--) Kia Sportage III (09/09--)	
Control arm set		316 050 0000/HD	MCK0015HD
<b>Notes</b>  Aluminium Carbon Neutral Front Axle Left Front Axle Right Pre-assembled with ball joint with holder  Required quantity reinforced version		 	
<b>References</b> The references of this product can be found at <a href="http://www.meyle.com">www.meyle.com</a>			
<b>Application info</b> BMW 3 (E46) (12/97-12/07) BMW Z4 (E86) (03/06-01/09)		BMW Z4 (E85) (09/02-12/09)	



**Control arm set**

316 050 0023/HD

MCK0016HD

**Notes**

Carbon Neutral  
 Front Axle Left  
 Front Axle Right  
 Pre-assembled  
 Steel  
 with ball joint  
 with holder

Required quantity  
 reinforced version

1



**References**

- BMW 1 092 276
- BMW 1 136 529
- BMW 1 140 399
- BMW 1 140 957
- BMW 2 339 996
- BMW 31 12 1 092 276
- BMW 31 12 1 136 529
- BMW 31 12 1 140 399
- BMW 31 12 1 140 957
- BMW 31 12 2 339 996
- BMW 31 12 6 758 513
- BMW 31 12 6 758 515
- BMW 6 758 513
- BMW 6 758 515

- BMW 1 094 275
- BMW 1 136 530
- BMW 1 140 400
- BMW 1 140 958
- BMW 2 339 997
- BMW 31 12 1 094 275
- BMW 31 12 1 136 530
- BMW 31 12 1 140 400
- BMW 31 12 1 140 958
- BMW 31 12 2 339 997
- BMW 31 12 6 758 514
- BMW 31 12 6 758 516
- BMW 6 758 514
- BMW 6 758 516

**Application info**

BMW 3 (E36) (09/90-08/00)

BMW Z3 (E36/7, E36/8) (10/95-06/03)

**Control arm set**

316 050 0080/HD

MCK0031HD

**Notes**

Carbon Neutral  
 Front Axle Left  
 Front Axle Right  
 with accessories

Full Set  
 Required quantity  
 reinforced version

1

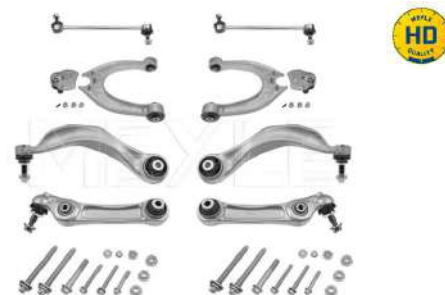

**References**

- |                                  |                                  |
|----------------------------------|----------------------------------|
| BMW 31 12 6 775 967              | BMW 31 12 6 775 971              |
| BMW 31 12 6 775 972              | BMW 31 12 6 779 871              |
| BMW 31 12 6 779 908              | BMW 31 12 6 794 203              |
| BMW 31 12 6 794 204              | BMW 31 12 6 854 613              |
| BMW 31 12 6 854 614              | BMW 31 12 6 857 516              |
| BMW 6 775 967                    | BMW 6 775 971                    |
| BMW 6 775 972                    | BMW 6 779 871                    |
| BMW 6 779 908                    | BMW 6 794 203                    |
| BMW 6 794 204                    | BMW 6 854 613                    |
| BMW 6 854 614                    | BMW 6 857 516                    |
| BMW (Brilliance) 31 12 6 775 967 | BMW (Brilliance) 31 12 6 775 971 |
| BMW (Brilliance) 31 12 6 775 972 | BMW (Brilliance) 31 12 6 794 203 |
| BMW (Brilliance) 6 775 967       | BMW (Brilliance) 6 775 971       |
| BMW (Brilliance) 6 775 972       | BMW (Brilliance) 6 794 203       |

**Application info**

- |                                |                                |
|--------------------------------|--------------------------------|
| BMW 5 (F10, F11) (01/09-02/17) | BMW 6 (F12, F13) (12/10-10/18) |
|--------------------------------|--------------------------------|

**Control arm set**

316 050 0101/HD

MCK0032HD

**Notes**

Carbon Neutral  
Front Axle Left  
Front Axle Right  
with accessories

Full Set  
Required quantity  
reinforced version

1



**References**

BMW 31 12 4 036 269

BMW 31 12 6 763 699

BMW 31 12 6 763 703

BMW 31 12 6 763 707

BMW 31 12 6 769 797

BMW 31 12 6 769 801

BMW 31 12 6 770 849

BMW 4 036 269

BMW 6 763 699

BMW 6 763 703

BMW 6 763 707

BMW 6 769 797

BMW 6 769 801

BMW 6 770 849

BMW (Brilliance) 31 12 4 036 269

BMW (Brilliance) 31 12 6 763 699

BMW (Brilliance) 31 12 6 763 703

BMW (Brilliance) 31 12 6 763 707

BMW (Brilliance) 31 12 6 769 797

BMW (Brilliance) 31 12 6 769 801

BMW (Brilliance) 31 12 6 770 849

BMW (Brilliance) 4 036 269

BMW (Brilliance) 6 763 699

BMW (Brilliance) 6 763 703

BMW (Brilliance) 6 763 707

BMW (Brilliance) 6 769 797

BMW (Brilliance) 6 769 801

BMW (Brilliance) 6 770 849

BMW 31 12 4 036 270

BMW 31 12 6 763 700

BMW 31 12 6 763 704

BMW 31 12 6 763 708

BMW 31 12 6 769 798

BMW 31 12 6 769 802

BMW 31 12 6 770 850

BMW 4 036 270

BMW 6 763 700

BMW 6 763 704

BMW 6 763 708

BMW 6 769 798

BMW 6 769 802

BMW 6 770 850

BMW (Brilliance) 31 12 4 036 270

BMW (Brilliance) 31 12 6 763 700

BMW (Brilliance) 31 12 6 763 704

BMW (Brilliance) 31 12 6 763 708

BMW (Brilliance) 31 12 6 769 798

BMW (Brilliance) 31 12 6 769 802

BMW (Brilliance) 31 12 6 770 850

BMW (Brilliance) 4 036 270

BMW (Brilliance) 6 763 700

BMW (Brilliance) 6 763 704

BMW (Brilliance) 6 763 708

BMW (Brilliance) 6 769 798

BMW (Brilliance) 6 769 802

BMW (Brilliance) 6 770 850

**Application info**

BMW 1 (E81, E82, E87, E88) (02/03-12/13)

BMW X1 (E84) (03/09-06/15)

BMW 3 (E90, E91, E92, E93) (02/04-12/13)

BMW Z4 (E89) (02/09-08/16)

**Control arm set**

316 050 0103/HD

MCK0033HD

**Notes**

Carbon Neutral  
Front Axle Left  
Front Axle Right  
with accessories

Full Set  
Required quantity  
reinforced version

1



**References**

- |                     |                     |
|---------------------|---------------------|
| BMW 1 092 023       | BMW 1 092 024       |
| BMW 1 093 449       | BMW 1 093 450       |
| BMW 1 094 233       | BMW 1 094 234       |
| BMW 1 141 717       | BMW 1 141 718       |
| BMW 2 157 597       | BMW 2 341 219       |
| BMW 2 341 296       | BMW 31 12 1 092 023 |
| BMW 31 12 1 092 024 | BMW 31 12 1 093 449 |
| BMW 31 12 1 093 450 | BMW 31 12 1 094 233 |
| BMW 31 12 1 094 234 | BMW 31 12 1 141 717 |
| BMW 31 12 1 141 718 | BMW 31 12 2 157 597 |
| BMW 31 12 2 341 219 | BMW 31 12 2 341 296 |
| BMW 31 12 9 069 568 | BMW 9 069 568       |

**Application info**

BMW 5 (E39) (09/95-06/04)

**Control arm set**

316 050 0104/HD

MCK0034HD

**Notes**

Carbon Neutral  
Front Axle Left  
Front Axle Right  
with accessories

Full Set  
Required quantity  
reinforced version

1



**References**

BMW 2 348 046	BMW 2 348 047
BMW 31 10 2 348 046	BMW 31 10 2 348 047
BMW 31 10 4 026 719	BMW 31 10 4 026 720
BMW 31 12 4 028 607	BMW 31 12 4 028 608
BMW 31 12 4 046 437	BMW 31 12 4 046 438
BMW 31 12 6 760 181	BMW 31 12 6 760 182
BMW 31 12 6 760 183	BMW 31 12 6 760 184
BMW 31 12 6 765 995	BMW 31 12 6 765 996
BMW 31 12 6 768 297	BMW 31 12 6 768 298
BMW 31 12 6 774 825	BMW 31 12 6 774 826
BMW 4 026 719	BMW 4 026 720
BMW 4 028 607	BMW 4 028 608
BMW 4 046 437	BMW 4 046 438
BMW 6 760 181	BMW 6 760 182
BMW 6 760 183	BMW 6 760 184
BMW 6 765 995	BMW 6 765 996
BMW 6 768 297	BMW 6 768 298
BMW 6 774 825	BMW 6 774 826
BMW (Brilliance) 2 348 046	BMW (Brilliance) 2 348 047
BMW (Brilliance) 31 10 2 348 046	BMW (Brilliance) 31 10 2 348 047
BMW (Brilliance) 31 10 4 026 719	BMW (Brilliance) 31 10 4 026 720
BMW (Brilliance) 31 12 4 046 437	BMW (Brilliance) 31 12 4 046 438
BMW (Brilliance) 31 12 6 760 181	BMW (Brilliance) 31 12 6 760 182
BMW (Brilliance) 31 12 6 760 183	BMW (Brilliance) 31 12 6 760 184
BMW (Brilliance) 31 12 6 765 995	BMW (Brilliance) 31 12 6 765 996
BMW (Brilliance) 31 12 6 768 297	BMW (Brilliance) 31 12 6 768 298
BMW (Brilliance) 31 12 6 774 825	BMW (Brilliance) 31 12 6 774 826
BMW (Brilliance) 4 026 719	BMW (Brilliance) 4 026 720
BMW (Brilliance) 4 046 437	BMW (Brilliance) 4 046 438
BMW (Brilliance) 6 760 181	BMW (Brilliance) 6 760 182
BMW (Brilliance) 6 760 183	BMW (Brilliance) 6 760 184
BMW (Brilliance) 6 765 995	BMW (Brilliance) 6 765 996
BMW (Brilliance) 6 768 297	BMW (Brilliance) 6 768 298
BMW (Brilliance) 6 774 825	BMW (Brilliance) 6 774 826

**Application info**

BMW 5 (E60, E61) (12/01-12/10)

**Control arm set**

316 050 0105/HD

MCK0035HD

**Notes**

Carbon Neutral  
Front Axle Left  
Front Axle Right  
with accessories

Full Set  
Required quantity  
reinforced version

1

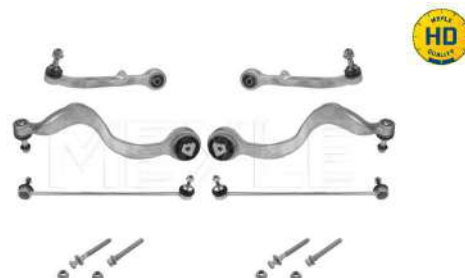

**References**

- |                     |                     |
|---------------------|---------------------|
| BMW 2 347 983       | BMW 2 347 984       |
| BMW 2 347 985       | BMW 2 347 986       |
| BMW 31 12 2 347 983 | BMW 31 12 2 347 984 |
| BMW 31 12 2 347 985 | BMW 31 12 2 347 986 |
| BMW 31 12 4 026 453 | BMW 31 12 4 026 454 |
| BMW 31 12 4 046 441 | BMW 31 12 4 046 442 |
| BMW 31 12 6 755 835 | BMW 31 12 6 755 836 |
| BMW 31 12 6 756 101 | BMW 31 12 6 756 102 |
| BMW 31 12 6 760 519 | BMW 31 12 6 760 520 |
| BMW 31 12 6 765 993 | BMW 31 12 6 765 994 |
| BMW 31 12 6 770 121 | BMW 31 12 6 770 122 |
| BMW 31 12 6 770 771 | BMW 31 12 6 770 772 |
| BMW 31 12 6 770 837 | BMW 31 12 6 770 838 |
| BMW 31 12 6 774 831 | BMW 31 12 6 774 832 |
| BMW 31 12 6 777 937 | BMW 31 12 6 777 938 |
| BMW 31 12 6 777 939 | BMW 31 12 6 777 940 |
| BMW 4 026 453       | BMW 4 026 454       |
| BMW 4 046 441       | BMW 4 046 442       |
| BMW 6 755 835       | BMW 6 755 836       |
| BMW 6 756 101       | BMW 6 756 102       |
| BMW 6 760 519       | BMW 6 760 520       |
| BMW 6 765 993       | BMW 6 765 994       |
| BMW 6 770 121       | BMW 6 770 122       |
| BMW 6 770 771       | BMW 6 770 772       |
| BMW 6 770 837       | BMW 6 770 838       |
| BMW 6 774 831       | BMW 6 774 832       |
| BMW 6 777 937       | BMW 6 777 938       |
| BMW 6 777 939       | BMW 6 777 940       |

**Application info**

BMW 7 (E65, E66) (07/01-12/09)

**Control arm set**

316 050 0106/HD

MCK0036HD

**Notes**

Carbon Neutral  
Front Axle Left  
Front Axle Right  
with accessories

Full Set

Required quantity  
reinforced version

1



**References**

- BMW 1 096 169
- BMW 1 096 315
- BMW 31 12 1 096 169
- BMW 31 12 1 096 315
- BMW 31 12 6 760 275
- BMW 31 12 6 769 717
- BMW 6 760 275
- BMW 6 769 717

- BMW 1 096 170
- BMW 1 096 316
- BMW 31 12 1 096 170
- BMW 31 12 1 096 316
- BMW 31 12 6 760 276
- BMW 31 12 6 769 718
- BMW 6 760 276
- BMW 6 769 718

**Application info**

BMW X5 (E53) (01/00-12/06)

**Control arm set**

316 050 0107/HD

MCK0037HD

**Notes**

Carbon Neutral  
Front Axle Left  
Front Axle Right  
with accessories

Full Set

Required quantity  
reinforced version

1



**References**

- |                     |                     |
|---------------------|---------------------|
| BMW 0 360 275       | BMW 0 363 477       |
| BMW 0 363 478       | BMW 2 229 521       |
| BMW 2 229 522       | BMW 2 229 523       |
| BMW 3 412 135       | BMW 3 412 136       |
| BMW 3 412 138       | BMW 3 415 027       |
| BMW 3 415 028       | BMW 3 418 337       |
| BMW 3 418 338       | BMW 3 426 433       |
| BMW 3 426 434       | BMW 3 443 127       |
| BMW 3 443 128       | BMW 3 451 881       |
| BMW 3 451 882       | BMW 31 10 0 363 477 |
| BMW 31 10 0 363 478 | BMW 31 10 2 229 523 |
| BMW 31 10 3 412 135 | BMW 31 10 3 412 136 |
| BMW 31 10 3 412 138 | BMW 31 10 3 415 027 |
| BMW 31 10 3 415 028 | BMW 31 10 3 418 337 |
| BMW 31 10 3 418 338 | BMW 31 10 3 426 433 |
| BMW 31 10 3 426 434 | BMW 31 10 3 443 127 |
| BMW 31 10 3 443 128 | BMW 31 10 3 451 881 |
| BMW 31 10 3 451 882 | BMW 31 12 0 360 275 |
| BMW 31 12 2 229 521 | BMW 31 12 2 229 522 |

**Application info**

BMW X3 (E83) (01/03-12/11)

**Control arm set**

316 050 0109/HD

MCK0052HD

**Notes**

Carbon Neutral  
 Front Axle Left  
 Front Axle Right  
 with attachment material

Full Set  
 Required quantity  
 reinforced version

1





**References**

BMW 31 12 6 771 893  
 BMW 31 12 6 773 949  
 BMW 31 12 6 776 417  
 BMW 31 12 6 863 333  
 BMW 31 12 6 863 335  
 BMW 31 12 6 863 785  
 BMW 6 771 893  
 BMW 6 773 949  
 BMW 6 776 417  
 BMW 6 863 333  
 BMW 6 863 335  
 BMW 6 863 785

BMW 31 12 6 771 894  
 BMW 31 12 6 773 950  
 BMW 31 12 6 776 418  
 BMW 31 12 6 863 334  
 BMW 31 12 6 863 336  
 BMW 31 12 6 863 786  
 BMW 6 771 894  
 BMW 6 773 950  
 BMW 6 776 418  
 BMW 6 863 334  
 BMW 6 863 336  
 BMW 6 863 786

**Application info**

BMW X5 (E70) (02/06-07/13)

BMW X6 (E71) (06/07-07/14)

**Control arm set**

316 050 0110/HD

MCK0059HD

**Notes**

Carbon Neutral  
 Front Axle Left  
 Front Axle Right  
 for vehicles with Adaptive Drive

Full Set  
 Required quantity  
 reinforced version

1



**References**

BMW 31 12 6 851 259  
 BMW 31 12 6 852 991  
 BMW 31 12 6 855 741  
 BMW 31 30 6 792 211  
 BMW 6 792 211  
 BMW 6 851 259  
 BMW 6 852 991  
 BMW 6 855 741  
 BMW (Brilliance) 31 12 6 851 259  
 BMW (Brilliance) 31 12 6 852 991  
 BMW (Brilliance) 31 12 6 855 741  
 BMW (Brilliance) 31 30 6 792 211  
 BMW (Brilliance) 6 792 211  
 BMW (Brilliance) 6 851 259  
 BMW (Brilliance) 6 852 991  
 BMW (Brilliance) 6 855 741

BMW 31 12 6 851 260  
 BMW 31 12 6 852 992  
 BMW 31 12 6 855 742  
 BMW 31 30 6 792 212  
 BMW 6 792 212  
 BMW 6 851 260  
 BMW 6 852 992  
 BMW 6 855 742  
 BMW (Brilliance) 31 12 6 851 260  
 BMW (Brilliance) 31 12 6 852 992  
 BMW (Brilliance) 31 12 6 855 742  
 BMW (Brilliance) 31 30 6 792 212  
 BMW (Brilliance) 6 792 212  
 BMW (Brilliance) 6 851 260  
 BMW (Brilliance) 6 852 992  
 BMW (Brilliance) 6 855 742

**Application info**

BMW 1 (F20, F21) (07/11--)  
 BMW 3 (F30, F31) (11/11-06/19)  
 BMW 4 (F32, F33, F36) (07/13--)

BMW 2 (F22,F23) (10/12--)  
 BMW 3 (F34) (07/12--)

**Control arm set**

316 050 0135/HD

MCK0056HD

**Notes**

Carbon Neutral  
 Control Arm  
 Front Axle Left  
 Front Axle Right  
 with ball joint  
 with rubber mount

Required quantity  
 reinforced version

1



**References**

- |                      |                      |
|----------------------|----------------------|
| BMW 2 785 113        | BMW 2 785 114        |
| BMW 31 12 2 785 113  | BMW 31 12 2 785 114  |
| BMW 31 12 6 851 203  | BMW 31 12 6 851 204  |
| BMW 31 12 6 871 301  | BMW 31 12 6 871 302  |
| BMW 31 12 6 879 843  | BMW 31 12 6 879 844  |
| BMW 6 851 203        | BMW 6 851 204        |
| BMW 6 871 301        | BMW 6 871 302        |
| BMW 6 879 843        | BMW 6 879 844        |
| Mini 2 785 113       | Mini 2 785 114       |
| Mini 31 12 2 785 113 | Mini 31 12 2 785 114 |
| Mini 31 12 6 851 203 | Mini 31 12 6 851 204 |
| Mini 31 12 6 871 301 | Mini 31 12 6 871 302 |
| Mini 31 12 6 879 843 | Mini 31 12 6 879 844 |
| Mini 6 851 203       | Mini 6 851 204       |
| Mini 6 871 301       | Mini 6 871 302       |
| Mini 6 879 843       | Mini 6 879 844       |

**Application info**

- |   |                            |
|---|----------------------------|
| BMW 1 (F40), 2 Gran Coupe (F44) (07/19--) | BMW 2 (F45, F46) (11/13--) |
| BMW X1 (F48) (11/14--)                    | BMW X2 (F39) (11/17--)     |
| Mini Countryman II (10/16--)              | Mini Mini III (09/13--)    |

**Control arm set**

316 050 0136/HD

MCK0057HD

**Notes**

Carbon Neutral  
Control Arm  
Front Axle Left  
Front Axle Right  
with ball joint  
with rubber mount

Required quantity  
reinforced version

1

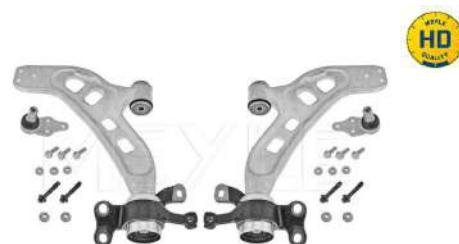

**References**

- |                      |                      |
|----------------------|----------------------|
| Mini 2 785 111       | Mini 2 785 112       |
| Mini 31 12 2 785 111 | Mini 31 12 2 785 112 |
| Mini 31 12 6 850 397 | Mini 31 12 6 850 398 |
| Mini 31 12 6 879 841 | Mini 31 12 6 879 842 |
| Mini 31 12 6 882 843 | Mini 31 12 6 882 844 |
| Mini 6 850 397       | Mini 6 850 398       |
| Mini 6 879 841       | Mini 6 879 842       |
| Mini 6 882 843       | Mini 6 882 844       |

**Application info**

Mini Mini III (09/13--)

**Mount, axle carrier**

316 710 0000

MCX0298

**Notes**

Front  
Lower  
Rear Axle Left  
Rear Axle Right  
Rubber-Metal Mount

Height [mm] 48  
Inner Diameter [mm] 12  
Outer Diameter [mm] 46  
Required quantity 2  
replacement in pairs recommended



**References**

BMW 33 32 6 763 092  
BMW (Brilliance) 33 32 6 763 092

BMW 6 763 092  
BMW (Brilliance) 6 763 092

**Application info**

BMW 1 (E81, E82, E87, E88) (02/03-12/13)  
BMW X1 (E84) (03/09-06/15)

BMW 3 (E90, E91, E92, E93) (02/04-12/13)

**Mount, control arm**

314 711 0003

MCM0132

**Notes**

Rear Axle Left  
Rear Axle Right  
without holder  
without retaining ring

Height [mm] 60.3  
Inner Diameter [mm] 16.1  
Outer Diameter [mm] 52  
Required quantity 2  
replacement in pairs recommended



**References**

BMW 33 32 6 780 438  
BMW (Brilliance) 33 32 6 780 438

BMW 6 780 438  
BMW (Brilliance) 6 780 438

**Application info**

BMW 5 (F07) (01/09-02/17)  
BMW 6 (F12, F13) (12/10-10/18)

BMW 5 (F10, F11) (01/09-02/17)  
BMW 7 (F01, F02, F03, F04) (02/08-12/15)

**Mount, control arm** **316 010 4347** **MCX0297**

**Notes**

Rear Axle Left  
Rear Axle Right  
with accessories  
without holder

Height [mm] 68  
Inner Diameter [mm] 16  
Outer Diameter [mm] 57  
Required quantity 2  
replacement in pairs recommended



**References**

- |                                  |                            |
|----------------------------------|----------------------------|
| BMW 1 090 504                    | BMW 1 095 631              |
| BMW 2 347 944                    | BMW 33 32 1 090 504        |
| BMW 33 32 1 095 631              | BMW 33 32 2 347 944        |
| BMW 33 32 6 750 371              | BMW 33 32 6 767 748        |
| BMW 6 750 371                    | BMW 6 767 748              |
| BMW (Brilliance) 33 32 6 767 748 | BMW (Brilliance) 6 767 748 |

**Application info**

- |                                |                                |
|--------------------------------|--------------------------------|
| BMW 5 (E39) (09/95-06/04)      | BMW 5 (E60, E61) (12/01-12/10) |
| BMW 6 (E63, E64) (09/03-12/10) | BMW 7 (E38) (03/94-11/01)      |
| BMW 7 (E65, E66) (07/01-12/09) | BMW X5 (E53) (01/00-12/06)     |
| BMW Z8 (E52) (01/00-12/03)     |                                |

**Mount, control arm** **32-14 610 0005** **MCB0235**

**Notes**

Front  
Front Axle Left  
Front Axle Right  
Lower  
without holder

Height [mm] 59  
Inner Diameter [mm] 14  
Outer Diameter [mm] 37  
Required quantity 2  
replacement in pairs recommended



**References**

Citroën 16 124 483 80

Citroën 16 127 533 80

Citroën 3520.V0

Citroën 3521.R1

Mitsubishi 4013A009

Mitsubishi 4013A281

Peugeot 16 12 753 380

Peugeot 16 124 484 80

Peugeot 3520.V0

Peugeot 3521.R1

Citroën 16 124 484 80

Citroën 16 127 535 80

Citroën 3520.X9

Citroën 3521.V0

Mitsubishi 4013A010

Mitsubishi 4013A282

Peugeot 16 124 483 80

Peugeot 16 127 535 80

Peugeot 3520.X9

Peugeot 3521.V0

**Application info**

Citroën C-Crosser (02/07--)

Mitsubishi ASX I (11/09--)

Mitsubishi Lancer VIII (03/07--)

Mitsubishi Outlander III (11/10--)

Peugeot 4008 (05/12--)

Citroën C4 AIRCROSS (08/10--)

Mitsubishi Lancer VII (03/00-12/13)

Mitsubishi Outlander II (11/06-12/12)

Peugeot 4007 (02/07-03/13)

**Mount, control arm****32-14 710 0007****MCB0523****Notes**

Rear Axle Left  
 Rear Axle Right  
 Rubber/Metal  
 Upper  
 inner  
 outer  
 without holder

Height [mm]

35

Inner Diameter [mm]

36.2

Outer Diameter [mm]

35.7

Required quantity

4

replacement in pairs recommended

**References**

Citroën 16 074 983 80

Peugeot 16 07 498 380

Mitsubishi MN184100

**Application info**

Citroën C4 AIRCROSS (08/10--)

Mitsubishi Lancer VII (03/00-12/13)

Mitsubishi Outlander II (11/06-12/12)

Peugeot 4008 (05/12--)

Mitsubishi ASX I (11/09--)

Mitsubishi Lancer VIII (03/07--)

Mitsubishi Outlander III (11/10--)

## Mount, control arm

35-14 610 0009/HD

MCM0079HD

## Notes

Carbon Neutral  
 Front Axle Left  
 Front Axle Right  
 Lower  
 Rear  
 with holder

Height [mm]

73

Inner Diameter [mm]

22

Replace in pairs only

Required quantity

2

Thread Size

M12x1,25

reinforced version



## References

Mazda B32H-34 300

Mazda B32H-34 350E

Mazda B32H-34-300B

Mazda B32H-34-300D

Mazda B32H-34-350A

Mazda B32H-34-350C

Mazda B37F-34-300A

Mazda B37F-34-350A

Mazda BP4K-34 300A

Mazda BP4K-34 350A

Mazda BP4K-34-300D

Mazda BP4K-34-350D

Mazda C513-34-300

Mazda CC30-34 300A

Mazda CC30-34 300C

Mazda CC30-34 300E

Mazda CC30-34 350B

Mazda CC30-34 350D

Mazda CD99-34-300A

Mazda B32H-34 350

Mazda B32H-34-300A

Mazda B32H-34-300C

Mazda B32H-34-300E

Mazda B32H-34-350B

Mazda B32H-34-350D

Mazda B37F-34-300B

Mazda B37F-34-350B

Mazda BP4K-34 300B

Mazda BP4K-34 350B

Mazda BP4K-34-350C

Mazda BP4K-34-350E

Mazda C513-34-350

Mazda CC30-34 300B

Mazda CC30-34 300D

Mazda CC30-34 350A

Mazda CC30-34 350C

Mazda CC30-34 350E

Mazda CD99-34-350A

## Application info

Mazda 3 (BK) (09/99-12/09)

Mazda 5 (CW) (06/10--)

Mazda 5 (CR) (02/05-12/10)

## Mount, control arm

35-14 610 0018

MCB0461

## Notes

Front Axle Left  
 Front Axle Right  
 Rear  
 without holder

Height [mm]

78

Inner Diameter [mm]

14.5

Outer Diameter [mm]

60

Required quantity

2

replacement in pairs recommended



## References

Ford 3L84-3A423-AC

Ford 4 133 882

Ford 4 484 852

Ford 4 631 871

Ford 4 763 903

Ford 4L84-3A423-AA

Ford 4L84-3A424-AA

Ford YL843-A423H-AA

Mazda EC01-34-300F

Mazda EC01-34-300H

Mazda EC01-34-300K

Mazda EC01-34-300M

Mazda EC01-34-350F

Mazda EC01-34-350H

Mazda EC01-34-350K

Mazda EC01-34-350M

Mazda EC04-34 300G

Ford 3L84-3A424-AC

Ford 4 133 883

Ford 4 484 853

Ford 4 631 878

Ford 4 763 905

Ford 4L84-3A423-AB

Ford 4L84-3A424-AB

Ford YL843-A424H-AA

Mazda EC01-34-300G

Mazda EC01-34-300J

Mazda EC01-34-300L

Mazda EC01-34-300N

Mazda EC01-34-350G

Mazda EC01-34-350J

Mazda EC01-34-350L

Mazda EC01-34-350N

## Application info

Ford Maverick II (02/01--)

Mazda Tribute I (EP) (03/00-05/08)



## Mount, control arm

35-14 610 0025

MCB0541

## Notes

Front  
 Front Axle Left  
 Front Axle Right  
 Rubber/Metal  
 Upper  
 without holder

Height [mm] 54  
 Inner Diameter [mm] 14  
 Outer Diameter [mm] 40  
 Required quantity 2  
 replacement in pairs recommended



## References

Mazda D10E-34-300  
 Mazda D10E-34-300B  
 Mazda D10E-34-350A

Mazda D10E-34-300A  
 Mazda D10E-34-350  
 Mazda D10E-34-350B

## Application info

Mazda CX-3 (DK) (01/15--)

## Mount, control arm

35-14 610 0026

MCB0542

## Notes

Front Axle Left  
 Front Axle Right  
 Rear  
 Rubber/Metal  
 Upper  
 without holder

Height [mm] 62  
 Inner Diameter [mm] 21  
 Outer Diameter [mm] 80  
 Required quantity 2  
 replacement in pairs recommended



## References

Mazda D10E-34-300  
 Mazda D10E-34-300B  
 Mazda D10E-34-350A

Mazda D10E-34-300A  
 Mazda D10E-34-350  
 Mazda D10E-34-350B

## Application info

Mazda CX-3 (DK) (01/15--)

**Mount, control arm****35-14 710 0004****MCM0193****Notes**

Rear Axle Left  
Rear Axle Right  
without holder

Height [mm] 55  
Inner Diameter [mm] 12  
Outer Diameter [mm] 43  
Required quantity 2  
replacement in pairs recommended

**References**

Mazda KD35-28-500

**Application info**

Mazda CX-5 I (KE) (11/11-02/17)

**Mount, control arm****36-14 610 0009****MCB0248****Notes**

Front  
Front Axle Left  
Front Axle Right  
Lower  
without holder

Length [mm] 115  
Outer Diameter [mm] 33  
Required quantity 2  
replacement in pairs recommended

**References**

Nissan 54500-BB00A  
Nissan 54500-JD000  
Nissan 54500-JG00B  
Nissan 54501-BB00A  
Nissan 54501-JD000  
Nissan 54501-JG000  
Renault 54501JY00A  
Renault 545055212R

Nissan 54500-BR30A  
Nissan 54500-JG00A  
Nissan 545004CA0A  
Nissan 54501-BR30A  
Nissan 54501-JD00A  
Nissan 54501-JG00B  
Renault 545040445R

**Application info**

Nissan Qashqai I (J10\_) (12/06-04/14)  
Nissan X-Trail (T32) (10/13--)

Nissan X-Trail (T31) (03/07-12/18)  
Renault Koleos I (09/08--)

**Mount, control arm**

36-14 610 0010/HD

MCB0249HD

**Notes**

Carbon Neutral  
 Front Axle Left  
 Front Axle Right  
 Lower  
 Rear  
 without holder

Height [mm] 53  
 Inner Diameter [mm] 12  
 Outer Diameter [mm] 58  
 Replace in pairs only  
 Required quantity 2  
 reinforced version



**References**

- |                    |                    |
|--------------------|--------------------|
| Nissan 54500-1KA0A | Nissan 54500-1KA0B |
| Nissan 54500-BB00A | Nissan 54500-BR30A |
| Nissan 54500-JD000 | Nissan 54500-JG000 |
| Nissan 54501-1KA0A | Nissan 54501-1KA0B |
| Nissan 54501-1KA1B | Nissan 54501-BB00A |
| Nissan 54501-BR30A | Nissan 54501-JD000 |
| Nissan 54501-JG000 | Nissan 54501-JG00B |
| Renault 54501JY00A | Renault 545040445R |
| Renault 545055212R |                    |

**Application info**

- |                                       |                                    |
|---------------------------------------|------------------------------------|
| Nissan Juke (F15) (06/10--)           | Nissan Leaf I (ZE0) (11/10--)      |
| Nissan Qashqai I (J10_) (12/06-04/14) | Nissan X-Trail (T31) (03/07-12/18) |
| Renault Koleos I (09/08--)            |                                    |

**Mount, control arm**

36-14 610 0024

MCB0477

**Notes**

Front  
 Front Axle Left  
 Front Axle Right  
 without holder

Height [mm] 45  
 Inner Diameter [mm] 12  
 Outer Diameter [mm] 44.5  
 Required quantity 2  
 replacement in pairs recommended



**References**

Nissan 54500-1HA0C  
 Nissan 54500-1HA5D  
 Nissan 54501-1HA0C  
 Nissan 54501-1HA5D

Nissan 54500-1HA5A  
 Nissan 54500-1HA6A  
 Nissan 54501-1HA5A  
 Nissan 54501-1HA6A

**Application info**

Nissan Micra (K13) (05/10--)

Nissan Note II (09/12--)

**Mount, control arm**

36-14 610 0025

MCB0478

**Notes**

Front Axle Left  
 Front Axle Right  
 Rear  
 without holder

Height [mm] 50  
 Inner Diameter [mm] 19  
 Outer Diameter [mm] 53  
 Required quantity 2  
 replacement in pairs recommended

**References**

Nissan 54500-1HA0C  
 Nissan 54500-1HA5D  
 Nissan 54501-1HA0C  
 Nissan 54501-1HA5D

Nissan 54500-1HA5A  
 Nissan 54500-1HA6A  
 Nissan 54501-1HA5A  
 Nissan 54501-1HA6A

**Application info**

Nissan Micra (K13) (05/10--)

Nissan Note II (09/12--)

**Mount, control arm**

36-14 610 0026

MCB0359

**Notes**

Front  
 Front Axle Left  
 Front Axle Right  
 without holder

Height [mm] 49  
 Inner Diameter [mm] 14  
 Outer Diameter [mm] 50  
 Required quantity 2  
 replacement in pairs recommended



**References**

Nissan 54500-1KA0A  
 Nissan 54500-1KA1B  
 Nissan 54501-1KA0B

Nissan 54500-1KA0B  
 Nissan 54501-1KA0A  
 Nissan 54501-1KA1B

**Application info**

Nissan Juke (F15) (06/10--)

Nissan Leaf I (ZE0) (11/10--)

**Mount, control arm**

37-14 610 0017

MCB0259

**Notes**

Front Axle Left  
 Front Axle Right  
 Lower  
 Rear  
 without holder

Height [mm] 60  
 Inner Diameter [mm] 14  
 Outer Diameter [mm] 66  
 Required quantity 2  
 replacement in pairs recommended

**References**

Hyundai 54584-1G000

Kia 54584 1G000

**Application info**

Hyundai Accent III (11/05-12/12)

Kia Rio II (03/05--)

**Mount, control arm**

37-14 610 0018

MCB0260

**Notes**

Front  
 Front Axle Left  
 Front Axle Right  
 Lower  
 without holder

Height [mm] 54  
 Inner Diameter [mm] 12  
 Outer Diameter [mm] 33  
 Required quantity 2  
 replacement in pairs recommended



**References**

Hyundai 54551-07000  
 Hyundai 54551-2K000  
 Kia 54551 1E000  
 Kia 54551-07000

Hyundai 54551-1E000  
 Kia 54551 07001  
 Kia 54551 2K000

**Application info**

Hyundai Accent III (11/05-12/12)  
 Hyundai ix20 (11/10--)  
 Kia Rio II (03/05--)  
 Kia Venga (02/10--)

Hyundai i10 I (10/07--)  
 Kia Picanto I (04/04--)  
 Kia Soul I (01/09--)

**Mount, control arm****37-14 610 0028****MCB0504****Notes**

Front  
 Front Axle Left  
 Front Axle Right  
 without holder

Height [mm] 55  
 Inner Diameter [mm] 12  
 Outer Diameter [mm] 38  
 Required quantity 2  
 replacement in pairs recommended

**References**

Hyundai 54551-2S000

Kia 54551-2S000

**Application info**

Hyundai Tucson I (06/04--)  
 Kia Sportage III (09/09--)

Hyundai ix35 (08/09--)

Mount, control arm		37-14 610 0034	MCB0517
<b>Notes</b>  Front Axle Left Front Axle Right Lower Rear inner without holder  Height [mm] 60 Inner Diameter [mm] 14.1 Outer Diameter [mm] 70.5 Required quantity 2 replacement in pairs recommended			
<b>References</b> Hyundai 54584-F2000			
<b>Application info</b> Hyundai Elantra VI (09/15--) Hyundai Kona I (06/17--)			

Mount, control arm		37-14 610 0035	MCB0518
<b>Notes</b>  Front Front Axle Left Front Axle Right Lower inner without holder  Height [mm] 54 Inner Diameter [mm] 12 Outer Diameter [mm] 39 Required quantity 2 replacement in pairs recommended			
<b>References</b> Hyundai 54500-3Z700 Hyundai 54551-3X000 Hyundai 54501-3Z700 Kia 54551 3X000			

**Application info**

Hyundai Creta I (01/16--)  
 Hyundai Elantra V (09/10--)  
 Hyundai Elantra VII (03/20--)  
 Hyundai Kona I (06/17--)  
 Hyundai Veloster I (03/11-12/17)  
 Hyundai i30 III (11/16--)  
 Kia Cee'd II (05/12--)  
 Kia Ceed IV (03/18--)  
 Kia Cerato IV (BD, BDM) (02/18--)  
 Kia Soul III (SK3) (01/19--)

Hyundai Creta II (SU2\_) (03/20--)  
 Hyundai Elantra VI (09/15--)  
 Hyundai Ioniq (AE) (03/16--)  
 Hyundai Kona II (04/23--)  
 Hyundai i30 II (06/11--)  
 Hyundai i40 (07/11--)  
 Kia Cee'd III (03/12--)  
 Kia Cerato III (YD) (09/12--)  
 Kia Niro I (DE) (09/16--)

**Mount, control arm****37-14 711 0002****MCM0143****Notes**

Rear Axle Left  
 Rear Axle Right  
 without holder

Height [mm] 59  
 Inner Diameter [mm] 14  
 Outer Diameter [mm] 44  
 Required quantity 2  
 replacement in pairs recommended

**References**

Hyundai 55130-3U000  
 Kia 55130 3U000

Hyundai 55130-4D000  
 Kia 55130 4D000

**Application info**

Hyundai Elantra IV (09/05--)  
 Hyundai Grandeur V (01/11--)  
 Hyundai Sonata VII (06/14--)  
 Hyundai Staria (US4) (01/21--)  
 Hyundai i30 III (11/16--)  
 Hyundai ix55 (09/06--)  
 Kia Carens III (05/06--)  
 Kia Cee'd I (12/06-02/13)  
 Kia Optima (01/10--)  
 Kia Sorento II (06/09--)  
 Kia Sportage III (09/09--)

Hyundai Genesis I (01/08--)  
 Hyundai Santa Fé III (09/12--)  
 Hyundai Sonata VIII (03/19--)  
 Hyundai i30 I (10/07-06/12)  
 Hyundai i40 (07/11--)  
 Kia Carens II (07/02--)  
 Kia Carnival III (09/05--)  
 Kia Magentis II (10/05--)  
 Kia Optima IV (09/15--)  
 Kia Sorento III (01/15--)



**Mount, wheel bearing housing**

316 010 0004

MCX0295

**Notes**

Rear Axle Left  
 Rear Axle Right  
 Height [mm] 57  
 Inner Diameter [mm] 12  
 Outer Diameter [mm] 45  
 Required quantity 2  
 replacement in pairs recommended



**References**

BMW 1 138 722 BMW 1 140 345  
 BMW 33 30 6 852 895 BMW 33 32 1 138 722  
 BMW 33 32 1 140 345 BMW 33 32 6 775 551  
 BMW 6 775 551 BMW 6 852 895  
 BMW (Brilliance) 33 32 6 775 551 BMW (Brilliance) 6 775 551

**Application info**

BMW 3 (E36) (09/90-08/00) BMW 3 (E46) (12/97-12/07)  
 BMW Z4 (E85) (09/02-12/09) BMW Z4 (E86) (03/06-01/09)  
 BMW Z4 (E89) (02/09-08/16)

**Mount, wheel bearing housing**

316 010 0012

MCX0296

**Notes**

Lower  
 Rear Axle Left  
 Rear Axle Right  
 Height [mm] 67  
 Inner Diameter [mm] 16  
 Outer Diameter [mm] 52  
 Required quantity 2  
 replacement in pairs recommended



**References**

BMW 33 32 6 770 985 BMW 6 770 985

**Application info**

BMW X5 (E70) (02/06-07/13) BMW X5 (F15) (08/13-07/18)  
 BMW X6 (E71) (06/07-07/14) BMW X6 (F16) (08/14-07/19)

**Mount, wheel bearing housing**

316 710 0001

MCX0299

**Notes**

Rear Axle Left  
Rear Axle Right  
outer

Height [mm] 55  
Inner Diameter [mm] 14  
Outer Diameter [mm] 47  
Required quantity 2  
replacement in pairs recommended



**References**

- |                                  |                                  |
|----------------------------------|----------------------------------|
| BMW 2 406 293                    | BMW 33 32 2 406 293              |
| BMW 33 32 6 756 249              | BMW 33 32 6 775 552              |
| BMW 33 32 6 792 553              | BMW 6 756 249                    |
| BMW 6 775 552                    | BMW 6 792 553                    |
| BMW (Brilliance) 2 406 293       | BMW (Brilliance) 33 32 2 406 293 |
| BMW (Brilliance) 33 32 6 756 249 | BMW (Brilliance) 33 32 6 775 552 |
| BMW (Brilliance) 6 756 249       | BMW (Brilliance) 6 775 552       |

**Application info**

- |  |  |
|--|--|
| BMW 1 (E81, E82, E87, E88) (02/03-12/13) | BMW 1 (F20, F21) (07/11--)               |
| BMW 2 (F22,F23) (10/12--)                | BMW 3 (E90, E91, E92, E93) (02/04-12/13) |
| BMW 3 (F30, F31) (11/11-06/19)           | BMW 3 (F34) (07/12--)                    |
| BMW 3 (G20, G21) (11/18--)               | BMW 4 (F32, F33, F36) (07/13--)          |
| BMW 4 (G22, G23, G26) (07/20--)          | BMW X1 (E84) (03/09-06/15)               |
| BMW X3 (F25) (09/10-08/17)               | BMW X4 (F26) (05/13-03/18)               |
| BMW i8 (03/14-06/20)                     |  |

**Repair kit, stub axle**

316 754 0001

MCX0653

**Notes**

Rear Axle Left  
Rear Axle Right  
with mounting sleeves

Required quantity 2  
replacement in pairs recommended



**References**

BMW 1 090 504

BMW 33 32 1 090 504

BMW 33 32 6 750 371

BMW 6 750 371

BMW (Brilliance) 33 32 6 767 748

BMW 1 095 631

BMW 33 32 1 095 631

BMW 33 32 6 767 748

BMW 6 767 748

BMW (Brilliance) 6 767 748

**Application info**

BMW 5 (E39) (09/95-06/04)

BMW 6 (E63, E64) (09/03-12/10)

BMW 7 (E65, E66) (07/01-12/09)

BMW Z8 (E52) (01/00-12/03)

BMW 5 (E60, E61) (12/01-12/10)

BMW 7 (E38) (03/94-11/01)

BMW X5 (E53) (01/00-12/06)

**Rod/strut, suspension****316 035 0000****MSR0081****Notes**

Aluminium  
 Front  
 Guide Rod  
 Rear Axle Left  
 Rear Axle Right  
 Upper  
 with rubber mount

Length [mm]

212

Required quantity

2

Thread Size

M10x1,5

replacement in pairs recommended

**References**

BMW 1 095 414

BMW 33 32 6 768 269

BMW 33 32 6 774 796

BMW 6 770 742

BMW 33 32 1 095 414

BMW 33 32 6 770 742

BMW 6 768 269

BMW 6 774 796

**Application info**

BMW X5 (E53) (01/00-12/06)

## Rod/strut, suspension

316 035 0001

MSR0082

## Notes

Aluminium  
 Guide Rod  
 Rear Axle Left  
 Rear Axle Right  
 Upper  
 with rubber mount

Length [mm]

212

Required quantity

2

Thread Size

M10x1,5

replacement in pairs recommended



## References

BMW 0 300 946

BMW 0 398 361

BMW 0 403 294

BMW 0 414 345

BMW 0 421 750

BMW 1 096 797

BMW 2 282 065

BMW 2 348 886

BMW 2 779 820

BMW 33 32 0 300 946

BMW 33 32 0 398 361

BMW 33 32 0 403 294

BMW 33 32 0 414 345

BMW 33 32 0 421 750

BMW 33 32 1 096 797

BMW 33 32 2 282 065

BMW 33 32 2 348 886

BMW 33 32 2 779 820

BMW 33 32 6 763 324

BMW 33 32 6 768 268

BMW 33 32 6 770 753

BMW 33 32 6 774 795

BMW 33 32 6 777 424

BMW 6 763 324

BMW 6 768 268

BMW 6 770 753

BMW 6 774 795

BMW 6 777 424



## Application info



BMW 5 (E39) (09/95-06/04)

BMW 5 (E60, E61) (12/01-12/10)

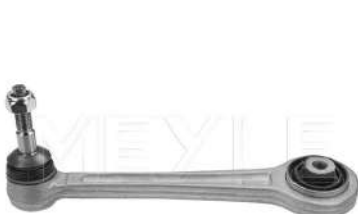
BMW 6 (E63, E64) (09/03-12/10)

BMW 7 (E65, E66) (07/01-12/09)

Rod/strut, suspension		316 035 0010	MSR0083
<b>Notes</b>  Aluminium Guide Rod Rear Axle Left Upper with rubber mount  Length [mm] 212 Paired article number 316 035 0011   MSR0084 Required quantity 1 Thread Size M12x1,5 replacement in pairs recommended			
<b>References</b> BMW 2 348 885 BMW 33 32 2 348 885 BMW 33 32 6 775 083 BMW 6 775 083			
<b>Application info</b> BMW 5 (E60, E61) (12/01-12/10) BMW 6 (E63, E64) (09/03-12/10) BMW 7 (E65, E66) (07/01-12/09)			
Rod/strut, suspension		316 035 0011	MSR0084
<b>Notes</b>  Aluminium Guide Rod Rear Axle Right Upper with rubber mount  Length [mm] 212 Paired article number 316 035 0010   MSR0083 Required quantity 1 Thread Size M12x1,5 replacement in pairs recommended			
<b>References</b> BMW 2 348 884 BMW 33 32 2 348 884 BMW 33 32 6 775 084 BMW 6 775 084			
<b>Application info</b> BMW 5 (E60, E61) (12/01-12/10) BMW 6 (E63, E64) (09/03-12/10) BMW 7 (E65, E66) (07/01-12/09)			

Rod/strut, suspension		316 035 0013/S	MSR0129
<p><b>Notes</b></p> <p>Length [mm]</p> <p>Paired article number</p> <p>Required quantity</p> <p>replacement in pairs recommended</p>	<p>Front</p> <p>Guide Rod</p> <p>Rear Axle Right</p> <p>Sheet Steel</p> <p>Upper</p> <p>with accessories</p> <p>with rubber mount</p> <p>245</p> <p>316 035 0014/S   MSR0130</p> <p>1</p>		
<p><b>References</b></p> <p>BMW 33 32 6 792 540</p> <p>BMW (Brilliance) 33 32 6 792 540</p> <p>BMW 6 792 540</p> <p>BMW (Brilliance) 6 792 540</p>			
<p><b>Application info</b></p> <p>BMW 1 (F20, F21) (07/11--)</p> <p>BMW 3 (F30, F31) (11/11-06/19)</p> <p>BMW 4 (F32, F33, F36) (07/13--)</p> <p>BMW 2 (F22,F23) (10/12--)</p> <p>BMW 3 (F34) (07/12--)</p>			
Rod/strut, suspension		316 035 0014/S	MSR0130
<p><b>Notes</b></p> <p>Length [mm]</p> <p>Paired article number</p> <p>Required quantity</p> <p>replacement in pairs recommended</p>	<p>Front</p> <p>Guide Rod</p> <p>Rear Axle Left</p> <p>Sheet Steel</p> <p>Upper</p> <p>with accessories</p> <p>with rubber mount</p> <p>245</p> <p>316 035 0013/S   MSR0129</p> <p>1</p>		
<p><b>References</b></p> <p>BMW 33 32 6 792 539</p> <p>BMW (Brilliance) 33 32 6 792 539</p> <p>BMW 6 792 539</p> <p>BMW (Brilliance) 6 792 539</p>			

**Application info**

BMW 1 (F20, F21) (07/11--)

BMW 3 (F30, F31) (11/11-06/19)

BMW 4 (F32, F33, F36) (07/13--)

BMW 2 (F22,F23) (10/12--)

BMW 3 (F34) (07/12--)

**Rod/strut, suspension**

316 035 0015/S

MSR0131

**Notes**

Guide Rod  
Rear  
Rear Axle Right  
Sheet Steel  
Upper  
with accessories  
with rubber mount

Length [mm]

290

Paired article number

316 035 0016/S | MSR0132

Required quantity

1

replacement in pairs recommended



**References**

BMW 33 32 6 792 544

BMW (Brilliance) 33 32 6 792 544

BMW 6 792 544

BMW (Brilliance) 6 792 544

**Application info**

BMW 1 (F20, F21) (07/11--)

BMW 3 (F30, F31) (11/11-06/19)

BMW 4 (F32, F33, F36) (07/13--)

BMW 2 (F22,F23) (10/12--)

BMW 3 (F34) (07/12--)

**Rod/strut, suspension**

316 035 0016/S

MSR0132

**Notes**

Guide Rod  
Rear  
Rear Axle Left  
Sheet Steel  
Upper  
with accessories  
with rubber mount

Length [mm]

290

Paired article number

316 035 0015/S | MSR0131

Required quantity

1

replacement in pairs recommended



**References**

BMW 33 32 6 792 543  
 BMW (Brilliance) 33 32 6 792 543

BMW 6 792 543  
 BMW (Brilliance) 6 792 543

**Application info**

BMW 1 (F20, F21) (07/11--)  
 BMW 3 (F30, F31) (11/11-06/19)  
 BMW 4 (F32, F33, F36) (07/13--)

BMW 2 (F22,F23) (10/12--)  
 BMW 3 (F34) (07/12--)

**Rod/strut, suspension**

316 035 0017

MSR0135

**Notes**

Guide Rod  
 Lower  
 Rear  
 Rear Axle Left  
 Rear Axle Right  
 Sheet Steel  
 with rubber mount

Length [mm]  
 Required quantity  
 replacement in pairs recommended

440  
 2



**References**

BMW 33 32 6 792 533  
 BMW (Brilliance) 33 32 6 792 533

BMW 6 792 533  
 BMW (Brilliance) 6 792 533

**Application info**

BMW 1 (F20, F21) (07/11--)  
 BMW 3 (F30, F31) (11/11-06/19)  
 BMW 4 (F32, F33, F36) (07/13--)

BMW 2 (F22,F23) (10/12--)  
 BMW 3 (F34) (07/12--)

**Rod/strut, suspension**

316 035 0018

MSR0136

**Notes**

Front  
 Guide Rod  
 Lower  
 Rear Axle Left  
 Rear Axle Right  
 Sheet Steel  
 with rubber mount

Length [mm]  
 Required quantity  
 replacement in pairs recommended

330  
 2





**References**

BMW 33 32 6 792 525  
 BMW (Brilliance) 33 32 6 792 525

BMW 6 792 525  
 BMW (Brilliance) 6 792 525

**Application info**

BMW 1 (F20, F21) (07/11--)  
 BMW 3 (F30, F31) (11/11-06/19)  
 BMW 4 (F32, F33, F36) (07/13--)  
 Vauxhall Mokka A (06/12--)

BMW 2 (F22,F23) (10/12--)  
 BMW 3 (F34) (07/12--)  
 Opel Mokka A (06/12--)

**Rod/strut, suspension**

316 035 0019

MSR0144

**Notes**

Guide Rod  
 Rear Axle Left  
 Upper  
 Length [mm] 331  
 Paired article number 316 035 0020 | MSR0145  
 Required quantity 1  
 replacement in pairs recommended



**References**

BMW 33 32 6 861 115  
 BMW 33 32 6 883 339  
 BMW 6 870 535

BMW 33 32 6 870 535  
 BMW 6 861 115  
 BMW 6 883 339

**Application info**

BMW 5 (G30, G31) (09/16--)  
 BMW 8 (G15) (07/18--)

BMW 7 (G11, G12) (07/15--)  
 BMW 8 Gran Coupe (G16) (07/19--)

**Rod/strut, suspension**

316 035 0020

MSR0145

**Notes**

Guide Rod  
 Rear Axle Right  
 Upper  
 Length [mm] 331  
 Paired article number 316 035 0019 | MSR0144  
 Required quantity 1  
 replacement in pairs recommended

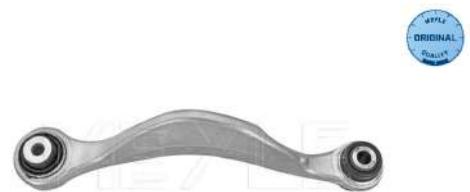

**References**

BMW 33 32 6 861 116  
 BMW 33 32 6 883 340  
 BMW 6 870 536

BMW 33 32 6 870 536  
 BMW 6 861 116  
 BMW 6 883 340

**Application info**

BMW 5 (G30, G31) (09/16--)  
 BMW 8 (G15) (07/18--)

BMW 7 (G11, G12) (07/15--)  
 BMW 8 Gran Coupe (G16) (07/19--)

**Rod/strut, suspension**

316 039 3807

MSR0086

**Notes**

Aluminium  
 Guide Rod  
 Rear Axle Left  
 Rear Axle Right  
 Upper  
 with rubber mount  
 Length [mm] 211  
 Required quantity 2  
 Thread Size M10x1,5

replacement in pairs recommended



**References**

BMW 1 090 745  
 BMW 33 32 1 090 745  
 BMW 33 32 6 768 791

BMW 1 097 264  
 BMW 33 32 1 097 264  
 BMW 6 768 791

**Application info**

BMW 5 (E39) (09/95-06/04)

BMW 7 (E38) (03/94-11/01)

**Rod/strut, suspension**

316 050 0024

MSR0087

**Notes**

Front  
 Guide Rod  
 Rear Axle Left  
 Rear Axle Right  
 Sheet Steel  
 Upper  
 with rubber mount

Length [mm] 241  
 Required quantity 2  
 replacement in pairs recommended



**References**

BMW 2 406 288	BMW 2 406 289
BMW 2 409 890	BMW 33 32 2 406 288
BMW 33 32 2 406 289	BMW 33 32 2 409 890
BMW 33 32 6 765 425	BMW 33 32 6 765 535
BMW 33 32 6 782 237	BMW 33 32 6 782 238
BMW 6 765 425	BMW 6 765 535
BMW 6 782 237	BMW 6 782 238
BMW (Brilliance) 33 32 6 782 237	BMW (Brilliance) 33 32 6 782 238
BMW (Brilliance) 6 782 237	BMW (Brilliance) 6 782 238

**Application info**

BMW 1 (E81, E82, E87, E88) (02/03-12/13)	BMW 3 (E90, E91, E92, E93) (02/04-12/13)
BMW X1 (E84) (03/09-06/15)	

**Rod/strut, suspension**

316 050 0025

MSR0088

**Notes**

Guide Rod  
 Rear Axle Left  
 Rear Axle Right  
 Sheet Steel  
 Upper  
 with rubber mount

Length [mm] 274  
 Required quantity 2  
 replacement in pairs recommended







**References**

BMW 2 406 292	BMW 33 32 2 406 292
BMW 33 32 6 763 473	BMW 33 32 6 777 980
BMW 34 52 6 778 469	BMW 6 763 473
BMW 6 777 980	BMW 6 778 469
BMW (Brilliance) 33 32 6 763 473	BMW (Brilliance) 33 32 6 777 980
BMW (Brilliance) 6 763 473	BMW (Brilliance) 6 777 980

**Application info**

BMW 1 (E81, E82, E87, E88) (02/03-12/13)	BMW 3 (E90, E91, E92, E93) (02/04-12/13)
--	--

Rod/strut, suspension		316 050 0026	MSR0089
<b>Notes</b>  Guide Rod Rear Rear Axle Left Rear Axle Right Sheet Steel Upper with rubber mount  Length [mm] 413 Required quantity 2 replacement in pairs recommended			
<b>References</b> BMW 2 406 290 BMW 2 409 892 BMW 33 32 2 406 290 BMW 33 32 2 409 892 BMW 33 32 6 763 471 BMW 6 763 471 BMW (Brilliance) 33 32 6 763 471 BMW (Brilliance) 6 763 471			
<b>Application info</b> BMW 1 (E81, E82, E87, E88) (02/03-12/13) BMW 3 (E90, E91, E92, E93) (02/04-12/13) BMW X1 (E84) (03/09-06/15)			
Rod/strut, suspension		316 050 0145	MSR0151
<b>Notes</b>  Front Guide Rod Lower Rear Axle Left Rear Axle Right  Length [mm] 343 Required quantity 2 replacement in pairs recommended			
<b>References</b> BMW 33 30 6 893 528 BMW 33 32 6 861 114 BMW 6 861 114 BMW 6 893 528			
<b>Application info</b> BMW 5 (G30, G31) (09/16--) BMW 5 (G60, G61) (07/23--) BMW 6 (G32) (06/17--) BMW 7 (G11, G12) (07/15--) BMW 8 (G15) (07/18--) BMW 8 Gran Coupe (G16) (07/19--)			

Rod/strut, suspension		316 050 0146	MSR0146
<p><b>Notes</b></p> <p>Front Guide Rod Rear Axle Right Upper</p> <p>Length [mm] 267 Paired article number 316 050 0147   MSR0147 Required quantity 1 replacement in pairs recommended</p>			
<p><b>References</b></p> <p>BMW 33 32 6 867 538 BMW 6 867 538</p>			
<p><b>Application info</b></p> <p>BMW 5 (G30, G31) (09/16--) BMW 7 (G11, G12) (07/15--) BMW 8 Gran Coupe (G16) (07/19--)</p> <p>BMW 6 (G32) (06/17--) BMW 8 (G15) (07/18--)</p>			
Rod/strut, suspension		316 050 0147	MSR0147
<p><b>Notes</b></p> <p>Front Guide Rod Rear Axle Left Upper</p> <p>Length [mm] 267 Paired article number 316 050 0146   MSR0146 Required quantity 1 replacement in pairs recommended</p>			
<p><b>References</b></p> <p>BMW 33 32 6 867 537 BMW 6 867 537</p>			
<p><b>Application info</b></p> <p>BMW 5 (G30, G31) (09/16--) BMW 7 (G11, G12) (07/15--) BMW 8 Gran Coupe (G16) (07/19--)</p> <p>BMW 6 (G32) (06/17--) BMW 8 (G15) (07/18--)</p>			

## Rod/strut, suspension

316 050 2100

MSR0090

## Notes

Guide Rod  
Lower  
Rear Axle Left  
Rear Axle Right  
Sheet Steel  
with rubber mount

Length [mm]

557

Required quantity

2

replacement in pairs recommended



## References

BMW 1 092 237

BMW 1 136 728

BMW 2 294 284

BMW 33 30 3 411 651

BMW 33 32 1 136 136

BMW 33 32 1 138 380

BMW 33 32 6 760 675

BMW 6 760 675

BMW (Brilliance) 33 32 6 770 813

BMW 1 136 136

BMW 1 138 380

BMW 3 411 651

BMW 33 32 1 092 237

BMW 33 32 1 136 728

BMW 33 32 2 294 284

BMW 33 32 6 770 813

BMW 6 770 813

BMW (Brilliance) 6 770 813

## Application info

BMW 3 (E36) (09/90-08/00)

BMW X3 (E83) (01/03-12/11)

BMW Z4 (E85) (09/02-12/09)

BMW Z4 (E89) (02/09-08/16)

BMW 3 (E46) (12/97-12/07)

BMW Z1 (06/88-06/91)

BMW Z4 (E86) (03/06-01/09)

## Rod/strut, suspension

316 060 4225

MSR0091

## Notes

Guide Rod  
Rear Axle Left  
Rear Axle Right  
Steel  
with rubber mount

Length [mm]

50

Required quantity

2

replacement in pairs recommended



**References**

BMW 1 123 463

BMW 1 126 476

BMW 33 32 1 125 665

BMW 1 125 665

BMW 33 32 1 123 463

BMW 33 32 1 126 476

**Application info**

BMW 5 (E28) (05/81-12/87)

BMW 6 (E24) (10/75-04/89)

BMW 7 (E32) (03/85-10/94)

BMW 5 (E34) (02/87-07/96)

BMW 7 (E23) (05/77-04/88)

**Rod/strut, suspension****32-16 035 0000****MSR0142****Notes**

Pull Rod  
Rear Axle Left  
Rear Axle Right  
Sheet Steel

Length [mm]

165.5

Required quantity

2

replacement in pairs recommended

**References**

Mitsubishi 4117A007

**Application info**

Mitsubishi Lancer VII (03/00-12/13)

Mitsubishi Outlander II (11/06-12/12)

Mitsubishi Lancer VIII (03/07--)

**Rod/strut, suspension****37-16 050 0093****MSR0148****Notes**

Front  
Guide Rod  
Lower  
Rear Axle Left  
Rear Axle Right

Length [mm]

235.6

Required quantity

2

replacement in pairs recommended

**References**

Hyundai 55250-D7000

Kia 55250 D7000

**Application info**

Hyundai Tucson II (05/15--)  
Kia Sportage IV (09/15--)

Hyundai ix35 (08/09--)

**Stabilizer link****316 060 0000/HD****MSL0305HD****Notes**

Carbon Neutral  
Coupling Rod  
Rear Axle Left  
Rear Axle Right  
for vehicles without active stabiliser control  
with spanner attachment

Length [mm] 207  
Required quantity 2  
Thread Size 1 M10x1,5  
Thread Size 2 M12x1,5  
reinforced version  
replacement in pairs recommended

**References**

BMW 33 50 6 781 538  
BMW 6 757 460

BMW 33 55 6 757 460  
BMW 6 781 538

**Application info**

BMW 7 (E65, E66) (07/01-12/09)

**Stabilizer link****316 060 0001/HD****MSL0306HD****Notes**

Carbon Neutral  
Coupling Rod  
with spanner attachment

Length [mm] 231  
Required quantity 2  
Thread Size 1 M10x1,5  
Thread Size 2 M10x1,5  
reinforced version  
replacement in pairs recommended

**References**

BMW 2 227 203  
Land Rover 6H525C486AB

BMW 31 35 2 227 203  
Land Rover LR002876



**Application info**

BMW 3 (E36) (09/90-08/00)

Land Rover Freelander II (10/06-12/15)

BMW Z3 (E36/7, E36/8) (10/95-06/03)

Land Rover Range Rover Evoque I (06/11-12/19)

**Stabilizer link**

316 060 0002/HD

MSL0307HD

**Notes**

Carbon Neutral  
Coupling Rod  
Front Axle Left  
Front Axle Right  
with spanner attachment

Length [mm]

285

Required quantity

2

Thread Size 1

M10x1,5

Thread Size 2

M10x1,5

reinforced version

replacement in pairs recommended



**References**

BMW 1 092 304

BMW 1 095 664

BMW 31 35 1 092 304

BMW 31 35 1 095 664

**Application info**

BMW 5 (E39) (09/95-06/04)

**Stabilizer link**

316 060 0003/HD

MSL0308HD

**Notes**

Carbon Neutral  
Coupling Rod  
Front Axle Left

Length [mm] 426

Paired article number 316 060 0004/HD | MSL0309HD

Required quantity 1

Thread Size 1 M10x1,5

Thread Size 2 M10x1,5

reinforced version

replacement in pairs recommended



**References**

BMW 31 30 6 781 545

BMW 31 35 6 753 767

BMW 31 35 6 778 069

BMW 6 753 767

BMW 6 778 069

BMW 6 781 545

**Application info**

BMW 7 (E65, E66) (07/01-12/09)

**Stabilizer link**

316 060 0004/HD

MSL0309HD

**Notes**Carbon Neutral  
Coupling Rod  
Front Axle RightLength [mm] 426  
Paired article number 316 060 0003/HD | MSL0308HD  
Required quantity 1  
Thread Size 1 M10x1,5  
Thread Size 2 M10x1,5  
reinforced version  
replacement in pairs recommended**References**

BMW 31 30 6 781 546

BMW 31 35 6 778 070

BMW 6 778 070

BMW 31 35 6 753 768

BMW 6 753 768

BMW 6 781 546

**Application info**

BMW 7 (E65, E66) (07/01-12/09)

**Stabilizer link**

316 060 0005/HD

MSL0310HD

**Notes**Carbon Neutral  
Coupling Rod  
Front Axle Left  
with spanner attachmentLength [mm] 358  
Paired article number 316 060 0006/HD | MSL0311HD  
Required quantity 1  
Thread Size 1 M12x1,5  
Thread Size 2 M12x1,5  
reinforced version  
replacement in pairs recommended**References**

BMW 31 35 6 750 703

BMW 6 750 703

**Application info**

BMW X5 (E53) (01/00-12/06)

**Stabilizer link**

316 060 0006/HD

MSL0311HD

**Notes**

Carbon Neutral  
Coupling Rod  
Front Axle Right  
with spanner attachment

Length [mm] 358  
Paired article number 316 060 0005/HD | MSL0310HD  
Required quantity 1  
Thread Size 1 M12x1,5  
Thread Size 2 M12x1,5  
reinforced version  
replacement in pairs recommended

**References**

BMW 31 35 6 750 704

BMW 6 750 704

**Application info**

BMW X5 (E53) (01/00-12/06)

**Stabilizer link**

316 060 0007/HD

MSL0312HD

**Notes**

Carbon Neutral  
Coupling Rod  
Front Axle Left  
Front Axle Right  
with spanner attachment

Length [mm] 240  
Required quantity 2  
Thread Size 1 M10x1,5  
Thread Size 2 M10x1,5  
reinforced version  
replacement in pairs recommended



**References**

BMW 1 701 066

BMW 31 35 1 701 066

**Application info**

BMW 3 (E30) (09/82-10/94)

Stabilizer link		316 060 0008/HD	MSL0313HD
<p><b>Notes</b></p> <p>Carbon Neutral Coupling Rod Rear Axle Left Rear Axle Right with spanner attachment</p> <p>Length [mm] 65 Required quantity 2 Thread Size 1 M12x1,5 Thread Size 2 M12x1,5 reinforced version replacement in pairs recommended</p>			
<p><b>References</b></p> <p>BMW 1 096 735 BMW 33 55 1 096 735</p>			
<p><b>Application info</b></p> <p>BMW X5 (E53) (01/00-12/06)</p>			
Stabilizer link		316 060 0009/HD	MSL0314HD
<p><b>Notes</b></p> <p>Carbon Neutral Coupling Rod Front Axle Left with spanner attachment</p> <p>Length [mm] 308 Paired article number 316 060 0010/HD   MSL0315HD Required quantity 1 Thread Size 1 M10x1,5 Thread Size 2 M10x1,5 reinforced version replacement in pairs recommended</p>			
<p><b>References</b></p> <p>BMW 31 35 6 751 079 BMW 6 751 079</p>			
<p><b>Application info</b></p> <p>BMW 3 (E46) (12/97-12/07)</p>			

**Stabilizer link**

316 060 0010/HD

MSL0315HD

**Notes**

Carbon Neutral  
Coupling Rod  
Front Axle Right  
with spanner attachment

Length [mm] 308  
Paired article number 316 060 0009/HD | MSL0314HD  
Required quantity 1  
Thread Size 1 M10x1,5  
Thread Size 2 M10x1,5  
reinforced version  
replacement in pairs recommended

**References**

BMW 31 35 6 751 080

BMW 6 751 080

**Application info**

BMW 3 (E46) (12/97-12/07)

**Stabilizer link**

316 060 0011/HD

MSL0316HD

**Notes**

Carbon Neutral  
Coupling Rod  
Rear Axle Left  
Rear Axle Right  
with spanner attachment

Length [mm] 95  
Required quantity 2  
Thread Size 1 M10x1,5  
Thread Size 2 M10x1,5  
reinforced version  
replacement in pairs recommended

**References**

BMW 3 412 794

BMW 3 413 197

BMW 3 414 297

BMW 33 50 3 412 794

BMW 33 50 3 413 197

BMW 33 50 3 414 297

**Application info**

BMW X3 (E83) (01/03-12/11)

**Stabilizer link** **316 060 0012/HD** **MSL0317HD**

**Notes**

Carbon Neutral  
Coupling Rod  
Rear Axle Left  
Rear Axle Right  
for vehicles without Adaptive Drive  
with spanner attachment



Length [mm] 158  
Required quantity 2  
Thread Size 1 M10x1,5  
Thread Size 2 M12x1,5  
reinforced version  
replacement in pairs recommended

**References**

BMW 33 50 6 781 540	BMW 33 55 6 761 000
BMW 6 761 000	BMW 6 781 540
BMW (Brilliance) 33 50 6 781 540	BMW (Brilliance) 6 781 540

**Application info**

BMW 5 (E60, E61) (12/01-12/10)	BMW 6 (E63, E64) (09/03-12/10)
--------------------------------	--------------------------------

**Stabilizer link** **316 060 0013/HD** **MSL0318HD**

**Notes**

Carbon Neutral  
Coupling Rod  
Front Axle Left

Length [mm] 300  
Paired article number 316 060 0014/HD | MSL0319HD  
Required quantity 1  
Thread Size 1 M10x1,5  
Thread Size 2 M10x1,5



reinforced version  
replacement in pairs recommended

**References**

- |                                  |                                  |
|----------------------------------|----------------------------------|
| BMW 2 347 945                    | BMW 31 30 6 781 547              |
| BMW 31 35 2 347 945              | BMW 31 35 4 014 531              |
| BMW 31 35 6 760 985              | BMW 31 35 6 769 499              |
| BMW 4 014 531                    | BMW 6 760 985                    |
| BMW 6 769 499                    | BMW 6 781 547                    |
| BMW (Brilliance) 31 30 6 781 547 | BMW (Brilliance) 31 35 4 014 531 |
| BMW (Brilliance) 31 35 6 760 985 | BMW (Brilliance) 31 35 6 769 499 |
| BMW (Brilliance) 4 014 531       | BMW (Brilliance) 6 760 985       |
| BMW (Brilliance) 6 769 499       | BMW (Brilliance) 6 781 547       |

**Application info**

BMW 5 (E60, E61) (12/01-12/10)

**Stabilizer link**

316 060 0014/HD

MSL0319HD

**Notes**

Carbon Neutral  
Coupling Rod  
Front Axle Right  
Length [mm] 300  
Paired article number 316 060 0013/HD | MSL0318HD  
Required quantity 1  
Thread Size 1 M10x1,5  
Thread Size 2 M10x1,5

reinforced version  
replacement in pairs recommended



**References**

- |                                  |                                  |
|----------------------------------|----------------------------------|
| BMW 2 347 945                    | BMW 31 30 6 781 548              |
| BMW 31 35 2 347 945              | BMW 31 35 4 014 532              |
| BMW 31 35 6 760 986              | BMW 31 35 6 769 500              |
| BMW 4 014 532                    | BMW 6 760 986                    |
| BMW 6 769 500                    | BMW 6 781 548                    |
| BMW (Brilliance) 31 30 6 781 548 | BMW (Brilliance) 31 35 4 014 532 |
| BMW (Brilliance) 31 35 6 760 986 | BMW (Brilliance) 31 35 6 769 500 |
| BMW (Brilliance) 4 014 532       | BMW (Brilliance) 6 760 986       |
| BMW (Brilliance) 6 769 500       | BMW (Brilliance) 6 781 548       |

**Application info**

BMW 5 (E60, E61) (12/01-12/10)

**Stabilizer link****316 060 0016/HD****MSL0320HD****Notes**

Carbon Neutral  
Coupling Rod  
Front Axle Left  
with spanner attachment

Length [mm] 290  
Paired article number 316 060 0017/HD | MSL0321HD  
Required quantity 1  
Thread Size 1 M10x1,5  
Thread Size 2 M10x1,5  
reinforced version  
replacement in pairs recommended

**References**

BMW 2 405 868

BMW 31 35 6 765 933

BMW (Brilliance) 31 35 6 765 933

BMW 31 35 2 405 868

BMW 6 765 933

BMW (Brilliance) 6 765 933

**Application info**

BMW 1 (E81, E82, E87, E88) (02/03-12/13)

BMW X1 (E84) (03/09-06/15)

BMW 3 (E90, E91, E92, E93) (02/04-12/13)

BMW Z4 (E89) (02/09-08/16)

**Stabilizer link****316 060 0017/HD****MSL0321HD****Notes**

Carbon Neutral  
Coupling Rod  
Front Axle Right  
with spanner attachment

Length [mm] 290  
Paired article number 316 060 0016/HD | MSL0320HD  
Required quantity 1  
Thread Size 1 M10x1,5  
Thread Size 2 M10x1,5  
reinforced version  
replacement in pairs recommended

**References**

BMW 2 405 868

BMW 31 35 6 765 934

BMW (Brilliance) 31 35 6 765 934

BMW 31 35 2 405 868

BMW 6 765 934

BMW (Brilliance) 6 765 934



**Application info**

BMW 1 (E81, E82, E87, E88) (02/03-12/13)

BMW X1 (E84) (03/09-06/15)

BMW 3 (E90, E91, E92, E93) (02/04-12/13)

BMW Z4 (E89) (02/09-08/16)

**Stabilizer link****316 060 0018/HD****MSL0322HD****Notes**

Carbon Neutral  
Coupling Rod  
Front Axle Left  
with spanner attachment

Length [mm]

300

Paired article number

316 060 0019/HD | MSL0323HD

Required quantity

1

Thread Size 1

M10x1,5

Thread Size 2

M10x1,5

reinforced version

replacement in pairs recommended

**References**

BMW 0 359 385

BMW 3 414 299

BMW 31 30 3 413 201

BMW 3 413 201

BMW 31 30 0 359 385

BMW 31 30 3 414 299

**Application info**

BMW X3 (E83) (01/03-12/11)

**Stabilizer link****316 060 0019/HD****MSL0323HD****Notes**

Carbon Neutral  
Coupling Rod  
Front Axle Right  
with spanner attachment

Length [mm]

300

Paired article number

316 060 0018/HD | MSL0322HD

Required quantity

1

Thread Size 1

M10x1,5

Thread Size 2

M10x1,5

reinforced version

replacement in pairs recommended



**References**

BMW 0 359 386

BMW 3 414 300

BMW 31 30 3 413 202

BMW 3 413 202

BMW 31 30 0 359 386

BMW 31 30 3 414 300

**Application info**

BMW X3 (E83) (01/03-12/11)

**Stabilizer link**

316 060 0020/HD

MSL0324HD

**Notes**

Carbon Neutral  
Coupling Rod  
Rear Axle Left  
Rear Axle Right  
with spanner attachment

Inner Diameter 1 [mm]

8

Length [mm]

160

Required quantity

2

Thread Size 1

M10x1,5

reinforced version

replacement in pairs recommended



**References**

BMW 2 406 281

BMW 33 55 6 764 428

BMW (Brilliance) 33 55 6 764 428

BMW 33 32 2 406 281

BMW 6 764 428

BMW (Brilliance) 6 764 428

**Application info**

BMW 1 (E81, E82, E87, E88) (02/03-12/13)

BMW 3 (E90, E91, E92, E93) (02/04-12/13)

**Stabilizer link**

316 060 0021/HD

MSL0325HD

**Notes**

Carbon Neutral  
Coupling Rod  
Front Axle Left  
Front Axle Right  
with spanner attachment

Length [mm]

331

Required quantity

2

Thread Size 1

M10x1,5

Thread Size 2

M10x1,5

reinforced version

replacement in pairs recommended



**References**

Mini 1 507 989

Mini 31 35 1 507 989

**Application info**

Mini Mini I (06/01-07/08)

**Stabilizer link**

316 060 0022/HD

MSL0326HD

**Notes**

Carbon Neutral  
Coupling Rod  
Front Axle Left  
Front Axle Right

Length [mm]

300

Required quantity

2

Thread Size 1

M10x1,5

Thread Size 2

M10x1,5

reinforced version

replacement in pairs recommended

**References**

Mini 31 35 6 759 537

Mini 31 35 6 778 831

Mini 6 759 537

Mini 6 778 831

**Application info**

Mini Mini I (06/01-07/08)

Mini Mini II (11/05-12/15)

**Stabilizer link**

316 060 0024/HD

MSL0328HD

**Notes**

Carbon Neutral  
Coupling Rod  
Rear Axle Left  
Rear Axle Right  
for vehicles with dynamic drive  
with spanner attachment

Length [mm]

215

Required quantity

2

Thread Size 1

M12x1,5

Thread Size 2

M12x1,5

reinforced version

replacement in pairs recommended



**References**

BMW 33 50 6 781 539  
BMW 6 753 770

BMW 33 55 6 753 770  
BMW 6 781 539

**Application info**

BMW 7 (E65, E66) (07/01-12/09)

**Stabilizer link**

316 060 0025/HD

MSL0329HD

**Notes**

Carbon Neutral  
Coupling Rod  
Front Axle Left  
with spanner attachment

Length [mm] 340  
Paired article number 316 060 0026/HD | MSL0330HD  
Required quantity 1  
Thread Size 1 M10x1,5  
Thread Size 2 M10x1,5  
reinforced version  
replacement in pairs recommended



**References**

BMW 31 35 6 768 771  
BMW (Brilliance) 31 35 6 768 771

BMW 6 768 771  
BMW (Brilliance) 6 768 771

**Application info**

BMW 3 (E90, E91, E92, E93) (02/04-12/13)

BMW X1 (E84) (03/09-06/15)

**Stabilizer link**

316 060 0026/HD

MSL0330HD

**Notes**

Carbon Neutral  
Coupling Rod  
Front Axle Right  
with spanner attachment

Length [mm] 340  
Paired article number 316 060 0025/HD | MSL0329HD  
Required quantity 1  
Thread Size 1 M10x1,5  
Thread Size 2 M10x1,5  
reinforced version  
replacement in pairs recommended



**References**

BMW 31 35 6 768 772

BMW (Brilliance) 31 35 6 768 772

BMW 6 768 772

BMW (Brilliance) 6 768 772

**Application info**

BMW 3 (E90, E91, E92, E93) (02/04-12/13)

BMW X1 (E84) (03/09-06/15)

**Stabilizer link**

316 060 0029/HD

MSL0332HD

**Notes**

Carbon Neutral  
Coupling Rod  
Rear Axle Left  
Rear Axle Right  
with spanner attachment

Length [mm]

161

Required quantity

2

Thread Size 1

M12x1,75

Thread Size 2

M12x1,5

reinforced version

replacement in pairs recommended



**References**

BMW 33 50 6 768 493

BMW 33 55 6 771 937

BMW 6 768 493

BMW 6 781 537

BMW 33 50 6 781 537

BMW 33 55 6 857 626

BMW 6 771 937

BMW 6 857 626

**Application info**

BMW 5 (E60, E61) (12/01-12/10)

BMW X5 (E70) (02/06-07/13)

BMW X6 (E71) (06/07-07/14)

BMW 6 (E63, E64) (09/03-12/10)

BMW X5 (F15) (08/13-07/18)

BMW X6 (F16) (08/14-07/19)

Stabilizer link		316 060 0030/HD	MSL0333HD
<b>Notes</b>	Carbon Neutral Coupling Rod Front Axle Left for vehicles without Adaptive Drive with spanner attachment		
Length [mm]	248		
Paired article number	316 060 0031/HD   MSL0334HD		
Required quantity	1		
Thread Size 1	M12x1,75		
Thread Size 2	M12x1,75		
reinforced version replacement in pairs recommended			

References	
BMW 31 35 6 773 023	BMW 31 35 6 857 623
BMW 31 35 6 859 651	BMW 6 773 023
BMW 6 857 623	BMW 6 859 651

Application info	
BMW X5 (E70) (02/06-07/13)	BMW X5 (F15) (08/13-07/18)
BMW X6 (E71) (06/07-07/14)	BMW X6 (F16) (08/14-07/19)

Stabilizer link		316 060 0031/HD	MSL0334HD
<b>Notes</b>	Carbon Neutral Coupling Rod Front Axle Right for vehicles without Adaptive Drive with spanner attachment		
Length [mm]	248		
Paired article number	316 060 0030/HD   MSL0333HD		
Required quantity	1		
Thread Size 1	M12x1,75		
Thread Size 2	M12x1,75		
reinforced version replacement in pairs recommended			

References	
BMW 31 35 6 773 024	BMW 31 35 6 857 624
BMW 31 35 6 859 652	BMW 6 773 024
BMW 6 857 624	BMW 6 859 652

**Application info**

BMW X5 (E70) (02/06-07/13)  
 BMW X6 (E71) (06/07-07/14)

BMW X5 (F15) (08/13-07/18)  
 BMW X6 (F16) (08/14-07/19)

**Stabilizer link**

316 060 0033/HD

MSL0335HD

**Notes**

Carbon Neutral  
 Coupling Rod  
 Front Axle Left  
 Front Axle Right  
 with spanner attachment

Length [mm] 300  
 Required quantity 2  
 Thread Size 1 M12x1,5  
 Thread Size 2 M12x1,5  
 reinforced version  
 replacement in pairs recommended



**References**

BMW 2 450 662  
 BMW 31 35 6 777 319  
 BMW (Brilliance) 31 35 6 777 319

BMW 31 35 2 450 662  
 BMW 6 777 319  
 BMW (Brilliance) 6 777 319

**Application info**

BMW 5 (F07) (01/09-02/17)  
 BMW 6 (F12, F13) (12/10-10/18)

BMW 5 (F10, F11) (01/09-02/17)  
 BMW 7 (F01, F02, F03, F04) (02/08-12/15)

**Stabilizer link**

316 060 0036

MSL0338

**Notes**

Coupling Rod  
 Front Axle Left  
 for vehicles with Adaptive Drive

Length [mm] 248  
 Paired article number 316 060 0037 | MSL0339  
 Required quantity 1  
 Thread Size 1 M12x1,5  
 Thread Size 2 M12x1,5  
 replacement in pairs recommended



**References**

BMW 37 11 6 771 929  
 BMW 37 11 6 859 653  
 BMW 6 857 627

BMW 37 11 6 857 627  
 BMW 6 771 929  
 BMW 6 859 653

**Application info**

BMW X5 (E70) (02/06-07/13)

BMW X6 (E71) (06/07-07/14)

BMW X5 (F15) (08/13-07/18)

BMW X6 (F16) (08/14-07/19)

**Stabilizer link****316 060 0037****MSL0339****Notes**

Coupling Rod  
Front Axle Right  
for vehicles with Adaptive Drive

Length [mm]

248

Paired article number

316 060 0036 | MSL0338

Required quantity

1

Thread Size 1

M12x1,5

Thread Size 2

M12x1,5

replacement in pairs recommended

**References**

BMW 37 11 6 771 930

BMW 37 11 6 859 654

BMW 6 857 628

BMW 37 11 6 857 628

BMW 6 771 930

BMW 6 859 654

**Application info**

BMW X5 (E70) (02/06-07/13)

BMW X6 (E71) (06/07-07/14)

BMW X5 (F15) (08/13-07/18)

BMW X6 (F16) (08/14-07/19)

**Stabilizer link****316 060 0038/HD****MSL0340HD****Notes**

Carbon Neutral  
Coupling Rod  
Front Axle Left  
with spanner attachment

Length [mm]

340

Paired article number

316 060 0039/HD | MSL0341HD

Required quantity

1

Thread Size 1

M12x1,5

Thread Size 2

M12x1,5

reinforced version

replacement in pairs recommended

**References**

BMW 31 30 6 787 163

BMW 6 787 163



**Application info**

BMW X3 (F25) (09/10-08/17)

BMW X4 (F26) (05/13-03/18)

**Stabilizer link**

316 060 0039/HD

MSL0341HD

**Notes**

Carbon Neutral  
Coupling Rod  
Front Axle Right  
with spanner attachment

Length [mm] 340  
Paired article number 316 060 0038/HD | MSL0340HD  
Required quantity 1  
Thread Size 1 M12x1,5  
Thread Size 2 M12x1,5  
reinforced version  
replacement in pairs recommended



**References**

BMW 31 30 6 787 164

BMW 6 787 164

**Application info**

BMW X3 (F25) (09/10-08/17)

BMW X4 (F26) (05/13-03/18)

**Stabilizer link**

316 060 0040/HD

MSL0342HD

**Notes**

Carbon Neutral  
Coupling Rod  
Front Axle  
with spanner attachment

Length [mm] 310  
Paired article number 316 060 0041/HD | MSL0343HD  
Required quantity 1  
Thread Size 1 M10x1,5  
Thread Size 2 M10x1,5  
reinforced version  
replacement in pairs recommended



**References**

BMW 31 30 6 792 211

BMW 6 792 211

BMW (Brilliance) 31 30 6 792 211

BMW (Brilliance) 6 792 211

**Application info**

BMW 1 (F20, F21) (07/11--)

BMW 3 (F30, F31) (11/11-06/19)

BMW 4 (F32, F33, F36) (07/13--)

BMW 2 (F22,F23) (10/12--)

BMW 3 (F34) (07/12--)

**Stabilizer link**

316 060 0041/HD

MSL0343HD

**Notes**

Carbon Neutral  
Coupling Rod  
Front Axle Right  
with spanner attachment

Length [mm]

310

Paired article number

316 060 0040/HD | MSL0342HD

Required quantity

1

Thread Size 1

M10x1,5

Thread Size 2

M10x1,5

reinforced version

replacement in pairs recommended



**References**

BMW 31 30 6 792 212

BMW (Brilliance) 31 30 6 792 212

BMW 6 792 212

BMW (Brilliance) 6 792 212

**Application info**

BMW 1 (F20, F21) (07/11--)

BMW 3 (F30, F31) (11/11-06/19)

BMW 4 (F32, F33, F36) (07/13--)

BMW 2 (F22,F23) (10/12--)

BMW 3 (F34) (07/12--)

**Stabilizer link**

316 060 0042/HD

MSL0344HD

**Notes**

Carbon Neutral  
Coupling Rod  
Rear Axle Left  
with spanner attachment

Length [mm]

136

Paired article number

316 060 0043/HD | MSL0345HD

Required quantity

1

Thread Size 1

M10x1,5

Thread Size 2

M10x1,5

reinforced version

replacement in pairs recommended



**References**

BMW 33 50 6 785 607  
 BMW (Brilliance) 33 50 6 785 607  
 Toyota 48840-WAA01

BMW 6 785 607  
 BMW (Brilliance) 6 785 607

**Application info**

BMW 1 (F20, F21) (07/11--)  
 BMW 2 (G42) (08/21--)  
 BMW 3 (F34) (07/12--)  
 BMW 4 (F32, F33, F36) (07/13--)  
 BMW X1 (E84) (03/09-06/15)  
 Toyota Supra V (\_A9\_) (03/19--)

BMW 2 (F22,F23) (10/12--)  
 BMW 3 (F30, F31) (11/11-06/19)  
 BMW 3 (G20, G21) (11/18--)  
 BMW 4 (G22, G23, G26) (07/20--)  
 BMW Z4 Roadster (G29) (11/18--)

**Stabilizer link****316 060 0043/HD****MSL0345HD****Notes**

Carbon Neutral  
 Coupling Rod  
 Rear Axle Right  
 with spanner attachment

Length [mm] 136  
 Paired article number 316 060 0042/HD | MSL0344HD  
 Required quantity 1  
 Thread Size 1 M10x1,5  
 Thread Size 2 M10x1,5

reinforced version  
 replacement in pairs recommended

**References**

BMW 33 50 6 785 608  
 BMW (Brilliance) 33 50 6 785 608  
 Toyota 48830-WAA01



BMW 6 785 608  
 BMW (Brilliance) 6 785 608





**Application info**



BMW 1 (F20, F21) (07/11--)  
 BMW 2 (G42) (08/21--)  
 BMW 3 (F34) (07/12--)  
 BMW 4 (F32, F33, F36) (07/13--)  
 BMW X1 (E84) (03/09-06/15)  
 Toyota Supra V (\_A9\_) (03/19--)



BMW 2 (F22,F23) (10/12--)  
 BMW 3 (F30, F31) (11/11-06/19)  
 BMW 3 (G20, G21) (11/18--)  
 BMW 4 (G22, G23, G26) (07/20--)  
 BMW Z4 Roadster (G29) (11/18--)



Stabilizer link		316 060 0048/HD	MSL0602HD
<b>Notes</b>  Carbon Neutral Coupling Rod Rear Axle Left Rear Axle Right with spanner attachment  Length [mm] 110 Required quantity 2 Thread Size 1 M12x1,5 Thread Size 2 M10x1,5 reinforced version replacement in pairs recommended			
<b>References</b> BMW 33 55 6 777 635 BMW 6 777 635 BMW (Brilliance) 33 55 6 777 635 BMW (Brilliance) 6 777 635			
<b>Application info</b> BMW 5 (F10, F11) (01/09-02/17) BMW 6 (F12, F13) (12/10-10/18) BMW 7 (F01, F02, F03, F04) (02/08-12/15)			
Stabilizer link		316 060 0049/HD	MSL0603HD
<b>Notes</b>  Carbon Neutral Coupling Rod Rear Axle Left Rear Axle Right with spanner attachment  Length [mm] 200 Required quantity 2 Thread Size 1 M12x1,5 Thread Size 2 M12x1,5 reinforced version replacement in pairs recommended			
<b>References</b> BMW 2 450 704 BMW 33 32 2 450 704 BMW 33 55 6 786 429 BMW 6 786 429			
<b>Application info</b> BMW 5 (F07) (01/09-02/17) BMW 5 (F10, F11) (01/09-02/17)			

Stabilizer link		316 060 0050/HD	MSL0609HD
<b>Notes</b>  Carbon Neutral Coupling Rod Rear Axle Left Rear Axle Right with spanner attachment  Length [mm] 110 Required quantity 2 Thread Size 1 M12x1,5 Thread Size 2 M12x1,5 reinforced version replacement in pairs recommended		 	
<b>References</b> BMW 37 10 6 775 189 BMW 6 775 189			
<b>Application info</b> BMW 5 (F10, F11) (01/09-02/17) BMW 6 (F12, F13) (12/10-10/18) BMW 7 (F01, F02, F03, F04) (02/08-12/15)			
Stabilizer link		316 060 0051/HD	MSL0596HD
<b>Notes</b>  Carbon Neutral Coupling Rod Front Axle Left with spanner attachment  Length [mm] 422 Paired article number 316 060 0052/HD   MSL0597HD Required quantity 1 Thread Size 1 M10x1,5 Thread Size 2 M10x1,5 reinforced version replacement in pairs recommended		 	
<b>References</b> BMW 2 347 949 BMW 31 30 6 781 549 BMW 31 35 2 347 949 BMW 31 35 6 768 083 BMW 6 768 083 BMW 6 781 549			
<b>Application info</b> BMW 5 (E60, E61) (12/01-12/10)			

Stabilizer link		316 060 0052/HD	MSL0597HD
<p><b>Notes</b></p> <p>Carbon Neutral Coupling Rod Front Axle Right with spanner attachment</p> <p>Length [mm] 422</p> <p>Paired article number 316 060 0051/HD   MSL0596HD</p> <p>Required quantity 1</p> <p>Thread Size 1 M10x1,5</p> <p>Thread Size 2 M10x1,5</p> <p>reinforced version</p> <p>replacement in pairs recommended</p>			
<p><b>References</b></p> <p>BMW 2 347 949 BMW 31 30 6 781 550</p> <p>BMW 31 35 2 347 949 BMW 31 35 6 768 084</p> <p>BMW 6 768 084 BMW 6 781 550</p>			
<p><b>Application info</b></p> <p>BMW 5 (E60, E61) (12/01-12/10)</p>			
Stabilizer link		316 060 0054/HD	MSL0981HD
<p><b>Notes</b></p> <p>Carbon Neutral Coupling Rod Rear Axle Left Rear Axle Right</p> <p>Inner Diameter 2 [mm] 11</p> <p>Length [mm] 132</p> <p>Required quantity 2</p> <p>Thread Size 1 M10x1,5</p> <p>reinforced version</p> <p>replacement in pairs recommended</p>			
<p><b>References</b></p> <p>BMW 33 55 6 790 324 BMW 6 790 324</p>			
<p><b>Application info</b></p> <p>BMW X3 (F25) (09/10-08/17) BMW X4 (F26) (05/13-03/18)</p>			

Stabilizer link		316 060 0054	MSL0981
<p><b>Notes</b></p> <p>Coupling Rod Rear Axle Left Rear Axle Right</p> <p>Inner Diameter 2 [mm] 11 Length [mm] 132 Required quantity 2 Thread Size 1 M10x1,5 replacement in pairs recommended</p>			
<p><b>References</b></p> <p>BMW 33 55 6 790 324 BMW 6 790 324</p>			
<p><b>Application info</b></p> <p>BMW X3 (F25) (09/10-08/17) BMW X4 (F26) (05/13-03/18)</p>			
Stabilizer link		316 060 0056	MSL0681
<p><b>Notes</b></p> <p>Coupling Rod Front Axle Right</p> <p>Length [mm] 332 Paired article number 316 060 0057   MSL0682 Required quantity 1 Thread Size 1 M10x1,5 Thread Size 2 M10x1,5 replacement in pairs recommended</p>			
<p><b>References</b></p> <p>BMW 31 30 6 781 542 BMW 31 35 4 014 576 BMW 31 35 6 762 512 BMW 31 35 6 769 664 BMW 4 014 576 BMW 6 762 512 BMW 6 769 664 BMW 6 781 542</p>			
<p><b>Application info</b></p> <p>BMW 6 (E63, E64) (09/03-12/10)</p>			





**Stabilizer link** **316 060 0062** **MSL0807**

**Notes**

Coupling Rod  
 Front Axle Left  
 Front Axle Right  
 with spanner attachment

Length [mm] 270  
 Required quantity 2  
 Thread Size 1 M10x1,5  
 Thread Size 2 M10x1,5  
 replacement in pairs recommended



**References**

- |                                  |                                  |
|----------------------------------|----------------------------------|
| BMW 1 095 694                    | BMW 2 241 254                    |
| BMW 31 35 1 095 694              | BMW 31 35 2 241 254              |
| BMW 31 35 6 780 847              | BMW 6 780 847                    |
| BMW (Brilliance) 1 095 694       | BMW (Brilliance) 31 35 1 095 694 |
| BMW (Brilliance) 31 35 6 780 847 | BMW (Brilliance) 6 780 847       |

**Application info**

- |                            |                            |
|----------------------------|----------------------------|
| BMW 3 (E46) (12/97-12/07)  | BMW Z4 (E85) (09/02-12/09) |
| BMW Z4 (E86) (03/06-01/09) |                            |

**Stabilizer link** **316 060 0064** **MSL0809**

**Notes**

Coupling Rod  
 Front Axle Right

Length [mm] 426  
 Paired article number 316 060 0065 | MSL0810  
 Required quantity 1  
 Thread Size 1 M10x1,5  
 Thread Size 2 M10x1,5  
 replacement in pairs recommended





**References**

- |                     |                     |
|---------------------|---------------------|
| BMW 31 30 6 781 546 | BMW 31 35 6 753 768 |
| BMW 31 35 6 778 070 | BMW 6 753 768       |
| BMW 6 778 070       | BMW 6 781 546       |

**Application info**

- BMW 7 (E65, E66) (07/01-12/09)



Stabilizer link		316 060 0067	MSL0812
<b>Notes</b>  Coupling Rod Front Axle Left with spanner attachment  Length [mm] 358 Paired article number 316 060 0066   MSL0811 Required quantity 1 Thread Size 1 M12x1,5 Thread Size 2 M12x1,5 replacement in pairs recommended			
<b>References</b> BMW 31 35 6 750 703 BMW 6 750 703			
<b>Application info</b> BMW X5 (E53) (01/00-12/06)			
Stabilizer link		316 060 0068	MSL0813
<b>Notes</b>  Coupling Rod Rear Axle Left Rear Axle Right with spanner attachment  Length [mm] 65 Required quantity 2 Thread Size 1 M12x1,5 Thread Size 2 M12x1,5 replacement in pairs recommended			
<b>References</b> BMW 1 096 735 BMW 33 55 1 096 735			
<b>Application info</b> BMW X5 (E53) (01/00-12/06)			

**Stabilizer link** **316 060 0072** **MSL0817**

**Notes**

Coupling Rod  
 Front Axle Right  
 Length [mm] 300  
 Paired article number 316 060 0073 | MSL0818  
 Required quantity 1  
 Thread Size 1 M10x1,5  
 Thread Size 2 M10x1,5  
 replacement in pairs recommended



**References**

- |                                  |                                  |
|----------------------------------|----------------------------------|
| BMW 2 347 945                    | BMW 31 30 6 781 548              |
| BMW 31 35 2 347 945              | BMW 31 35 4 014 532              |
| BMW 31 35 6 760 986              | BMW 31 35 6 769 500              |
| BMW 4 014 532                    | BMW 6 760 986                    |
| BMW 6 769 500                    | BMW 6 781 548                    |
| BMW (Brilliance) 31 30 6 781 548 | BMW (Brilliance) 31 35 4 014 532 |
| BMW (Brilliance) 31 35 6 760 986 | BMW (Brilliance) 31 35 6 769 500 |
| BMW (Brilliance) 4 014 532       | BMW (Brilliance) 6 760 986       |
| BMW (Brilliance) 6 769 500       | BMW (Brilliance) 6 781 548       |

**Application info**

BMW 5 (E60, E61) (12/01-12/10)

**Stabilizer link** **316 060 0073** **MSL0818**

**Notes**

Coupling Rod  
 Front Axle Left  
 Length [mm] 300  
 Paired article number 316 060 0072 | MSL0817  
 Required quantity 1  
 Thread Size 1 M10x1,5  
 Thread Size 2 M10x1,5  
 replacement in pairs recommended



**References**

- |                                  |                                  |
|----------------------------------|----------------------------------|
| BMW 2 347 945                    | BMW 31 30 6 781 547              |
| BMW 31 35 2 347 945              | BMW 31 35 4 014 531              |
| BMW 31 35 6 760 985              | BMW 31 35 6 769 499              |
| BMW 4 014 531                    | BMW 6 760 985                    |
| BMW 6 769 499                    | BMW 6 781 547                    |
| BMW (Brilliance) 31 30 6 781 547 | BMW (Brilliance) 31 35 4 014 531 |
| BMW (Brilliance) 31 35 6 760 985 | BMW (Brilliance) 31 35 6 769 499 |
| BMW (Brilliance) 4 014 531       | BMW (Brilliance) 6 760 985       |
| BMW (Brilliance) 6 769 499       | BMW (Brilliance) 6 781 547       |

**Application info**

BMW 5 (E60, E61) (12/01-12/10)

**Stabilizer link**

316 060 0074

MSL0819

**Notes**

Coupling Rod  
 Front Axle Right  
 with spanner attachment  
 Length [mm] 290  
 Paired article number 316 060 0075 | MSL0820  
 Required quantity 1  
 Thread Size 1 M10x1,5  
 Thread Size 2 M10x1,5

replacement in pairs recommended







**References**

- |                                  |                            |
|----------------------------------|----------------------------|
| BMW 2 405 868                    | BMW 31 35 2 405 868        |
| BMW 31 35 6 765 934              | BMW 6 765 934              |
| BMW (Brilliance) 31 35 6 765 934 | BMW (Brilliance) 6 765 934 |



**Application info**

- |  |  |
|--|--|
| BMW 1 (E81, E82, E87, E88) (02/03-12/13) | BMW 3 (E90, E91, E92, E93) (02/04-12/13) |
| BMW X1 (E84) (03/09-06/15)               | BMW Z4 (E89) (02/09-08/16)               |

Stabilizer link		316 060 0075	MSL0820
<b>Notes</b>  Coupling Rod Front Axle Left with spanner attachment  Length [mm] 290 Paired article number 316 060 0074   MSL0819 Required quantity 1 Thread Size 1 M10x1,5 Thread Size 2 M10x1,5 replacement in pairs recommended			
<b>References</b> BMW 2 405 868 BMW 31 35 2 405 868 BMW 31 35 6 765 933 BMW 6 765 933 BMW (Brilliance) 31 35 6 765 933 BMW (Brilliance) 6 765 933			
<b>Application info</b> BMW 1 (E81, E82, E87, E88) (02/03-12/13) BMW 3 (E90, E91, E92, E93) (02/04-12/13) BMW X1 (E84) (03/09-06/15) BMW Z4 (E89) (02/09-08/16)			
Stabilizer link		316 060 0076	MSL0821
<b>Notes</b>  Coupling Rod Front Axle Right with spanner attachment  Length [mm] 300 Paired article number 316 060 0077   MSL0822 Required quantity 1 Thread Size 1 M10x1,5 Thread Size 2 M10x1,5 replacement in pairs recommended			
<b>References</b> BMW 3 413 202 BMW 3 414 300 BMW 31 30 3 413 202 BMW 31 30 3 414 300			
<b>Application info</b> BMW X3 (E83) (01/03-12/11)			

Stabilizer link		316 060 0077	MSL0822
<p><b>Notes</b></p> <p>Coupling Rod Front Axle Left with spanner attachment</p> <p>Length [mm] 300</p> <p>Paired article number 316 060 0076   MSL0821</p> <p>Required quantity 1</p> <p>Thread Size 1 M10x1,5</p> <p>Thread Size 2 M10x1,5</p> <p>replacement in pairs recommended</p>			
<p><b>References</b></p> <p>BMW 3 413 201 BMW 3 414 299</p> <p>BMW 31 30 3 413 201 BMW 31 30 3 414 299</p>			
<p><b>Application info</b></p> <p>BMW X3 (E83) (01/03-12/11)</p>			
Stabilizer link		316 060 0078	MSL0823
<p><b>Notes</b></p> <p>Coupling Rod Front Axle Left Front Axle Right</p> <p>Length [mm] 300</p> <p>Required quantity 2</p> <p>Thread Size 1 M10x1,5</p> <p>Thread Size 2 M10x1,5</p> <p>replacement in pairs recommended</p>			
<p><b>References</b></p> <p>Mini 2 318 481 Mini 31 35 2 318 481</p> <p>Mini 31 35 6 759 537 Mini 31 35 6 778 831</p> <p>Mini 6 759 537 Mini 6 778 831</p>			
<p><b>Application info</b></p> <p>Mini Mini I (06/01-07/08) Mini Mini II (11/05-12/15)</p>			



Stabilizer link		316 060 0079	MSL0824
<b>Notes</b>  Coupling Rod Front Axle Left with spanner attachment  Length [mm] 340 Paired article number 316 060 0080   MSL0825 Required quantity 1 Thread Size 1 M10x1,5 Thread Size 2 M10x1,5 replacement in pairs recommended			
<b>References</b> BMW 2 405 869 BMW 31 35 2 405 869 BMW 31 35 6 768 771 BMW 6 768 771 BMW (Brilliance) 31 35 6 768 771 BMW (Brilliance) 6 768 771			
<b>Application info</b> BMW 3 (E90, E91, E92, E93) (02/04-12/13) BMW X1 (E84) (03/09-06/15)			
Stabilizer link		316 060 0080	MSL0825
<b>Notes</b>  Coupling Rod Front Axle Right with spanner attachment  Length [mm] 340 Paired article number 316 060 0079   MSL0824 Required quantity 1 Thread Size 1 M10x1,5 Thread Size 2 M10x1,5 replacement in pairs recommended			
<b>References</b> BMW 2 405 869 BMW 31 35 2 405 869 BMW 31 35 6 768 772 BMW 6 768 772 BMW (Brilliance) 31 35 6 768 772 BMW (Brilliance) 6 768 772			
<b>Application info</b> BMW 3 (E90, E91, E92, E93) (02/04-12/13) BMW X1 (E84) (03/09-06/15)			



**Application info**

BMW 3 (E30) (09/82-10/94)  
 BMW 5 (E28) (05/81-12/87)  
 BMW 6 (E24) (10/75-04/89)  
 BMW 8 (E31) (01/90-12/99)

BMW 3 (E36) (09/90-08/00)  
 BMW 5 (E34) (02/87-07/96)  
 BMW 7 (E32) (03/85-10/94)

**Stabilizer link****316 060 0085****MSL0830****Notes**

Coupling Rod  
 Front Axle Left  
 with spanner attachment

Length [mm] 240  
 Paired article number 316 060 0086 | MSL0831  
 Required quantity 1  
 Thread Size 1 M10x1,5  
 Thread Size 2 M10x1,5  
 replacement in pairs recommended

**References**

BMW 1 091 855 BMW 1 095 661  
 BMW 31 35 1 091 855 BMW 31 35 1 095 661

**Application info**

BMW 5 (E39) (09/95-06/04)

**Stabilizer link****316 060 0086****MSL0831****Notes**

Coupling Rod  
 Front Axle Right  
 with spanner attachment



Length [mm] 240  
 Paired article number 316 060 0085 | MSL0830  
 Required quantity 1  
 Thread Size 1 M10x1,5  
 Thread Size 2 M10x1,5  
 replacement in pairs recommended



**References**

BMW 1 091 856 BMW 1 095 662  
 BMW 31 35 1 091 856 BMW 31 35 1 095 662

**Application info**

BMW 5 (E39) (09/95-06/04)

Stabilizer link		316 060 0088	MSL0833
<b>Notes</b>  Coupling Rod Front Axle Right with spanner attachment  Length [mm] 340 Paired article number 316 060 0089   MSL0834 Required quantity 1 Thread Size 1 M12x1,5 Thread Size 2 M12x1,5 replacement in pairs recommended			
<b>References</b> BMW 2 457 373 BMW 31 30 6 787 164 BMW 31 35 2 457 373 BMW 6 787 164			
<b>Application info</b> BMW X3 (F25) (09/10-08/17) BMW X4 (F26) (05/13-03/18)			
Stabilizer link		316 060 0089	MSL0834
<b>Notes</b>  Coupling Rod Front Axle Left with spanner attachment  Length [mm] 340 Paired article number 316 060 0088   MSL0833 Required quantity 1 Thread Size 1 M12x1,5 Thread Size 2 M12x1,5 replacement in pairs recommended			
<b>References</b> BMW 2 457 373 BMW 31 30 6 787 163 BMW 31 35 2 457 373 BMW 6 787 163			
<b>Application info</b> BMW X3 (F25) (09/10-08/17) BMW X4 (F26) (05/13-03/18)			

Stabilizer link		316 060 0090	MSL0835
<p><b>Notes</b></p> <p>Coupling Rod with spanner attachment</p> <p>Length [mm] 310</p> <p>Paired article number 316 060 0091   MSL0836</p> <p>Required quantity 1</p> <p>Thread Size 1 M10x1,5</p> <p>Thread Size 2 M10x1,5</p> <p>replacement in pairs recommended</p>			
<p><b>References</b></p> <p>BMW 31 30 6 792 211 BMW 6 792 211</p> <p>BMW (Brilliance) 31 30 6 792 211 BMW (Brilliance) 6 792 211</p>			
<p><b>Application info</b></p> <p>BMW 1 (F20, F21) (07/11--)</p> <p>BMW 2 (F22,F23) (10/12--)</p> <p>BMW 3 (F30, F31) (11/11-06/19)</p> <p>BMW 3 (F34) (07/12--)</p> <p>BMW 4 (F32, F33, F36) (07/13--)</p>			
Stabilizer link		316 060 0091	MSL0836
<p><b>Notes</b></p> <p>Coupling Rod with spanner attachment</p> <p>Length [mm] 310</p> <p>Paired article number 316 060 0090   MSL0835</p> <p>Required quantity 1</p> <p>Thread Size 1 M10x1,5</p> <p>Thread Size 2 M10x1,5</p> <p>replacement in pairs recommended</p>			
<p><b>References</b></p> <p>BMW 31 30 6 792 212 BMW 6 792 212</p> <p>BMW (Brilliance) 31 30 6 792 212 BMW (Brilliance) 6 792 212</p>			
<p><b>Application info</b></p> <p>BMW 1 (F20, F21) (07/11--)</p> <p>BMW 2 (F22,F23) (10/12--)</p> <p>BMW 3 (F30, F31) (11/11-06/19)</p> <p>BMW 3 (F34) (07/12--)</p> <p>BMW 4 (F32, F33, F36) (07/13--)</p>			

**Stabilizer link****316 060 0092/HD****MSL0909HD****Notes**

Carbon Neutral  
Coupling Rod  
Front Axle Left  
Front Axle Right  
with spanner attachment

Length [mm]

320

Required quantity

2

Thread Size 1

M10x1,5

Thread Size 2

M10x1,5

reinforced version

replacement in pairs recommended

**References**

BMW 31 30 6 862 864

BMW (Brilliance) 31 30 6 862 864

Mini 31 30 6 862 864

BMW 6 862 864

BMW (Brilliance) 6 862 864

Mini 6 862 864

**Application info**

BMW 1 (F40), 2 Gran Coupe (F44) (07/19--)

BMW 2 (F45, F46) (11/13--)

BMW X2 (F39) (11/17--)

Mini Mini III (09/13--)

BMW 1 (F52) (01/17--)

BMW X1 (F48) (11/14--)

Mini Countryman II (10/16--)

**Stabilizer link****316 060 0093****MSL0945****Notes**

Coupling Rod  
Rear Axle Left  
Rear Axle Right

Length [mm]

104

Required quantity

2

Thread Size 1

M10x1,5

replacement in pairs recommended

**References**

BMW 33 50 6 862 865

BMW (Brilliance) 33 50 6 862 865

Mini 33 50 6 862 865

BMW 6 862 865

BMW (Brilliance) 6 862 865

Mini 6 862 865

**Application info**

BMW 1 (F40), 2 Gran Coupe (F44) (07/19--)  
 BMW X1 (F48) (11/14--)  
 BMW X2 (F39) (11/17--)  
 Mini Mini III (09/13--)

BMW 2 (F45, F46) (11/13--)  
 BMW X1 (U11) (07/22--)  
 Mini Countryman II (10/16--)

**Stabilizer link**

316 060 0094/HD

MSL0955HD

**Notes**

Carbon Neutral  
 Coupling Rod  
 Front Axle Left  
 Front Axle Right

Length [mm] 242  
 Required quantity 2  
 Thread Size 1 M12x1,5  
 Thread Size 2 M12x1,5  
 reinforced version  
 replacement in pairs recommended



**References**

BMW 31 30 6 861 483  
 BMW (Brilliance) 31 30 6 866 522

BMW 6 861 483  
 BMW (Brilliance) 6 866 522

**Application info**

BMW 5 (G30, G31) (09/16--)  
 BMW 7 (G11, G12) (07/15--)  
 BMW 8 Gran Coupe (G16) (07/19--)

BMW 6 (G32) (06/17--)  
 BMW 8 (G15) (07/18--)

**Stabilizer link**

316 060 0096/HD

MSL1056HD

**Notes**

Carbon Neutral  
 Coupling Rod  
 Front Axle Right

Length [mm] 317  
 Paired article number 316 060 0097/HD | MSL1057HD  
 Required quantity 1  
 Thread Size 1 M10x1,5  
 Thread Size 2 M10x1,5  
 reinforced version  
 replacement in pairs recommended



**References**

BMW 31 30 6 893 360  
 BMW (Brilliance) 31 30 6 893 360

BMW 6 893 360  
 BMW (Brilliance) 6 893 360

**Application info**

BMW 2 (G42) (08/21--)  
 BMW 4 (G22, G23, G26) (07/20--)

BMW 3 (G20, G21) (11/18--)  
 BMW i4 (G26) (11/21--)

**Stabilizer link**

**316 060 0097/HD**

**MSL1057HD**

**Notes**

Carbon Neutral  
 Coupling Rod  
 Front Axle Left  
 Length [mm] 317  
 Paired article number 316 060 0096/HD | MSL1056HD  
 Required quantity 1  
 Thread Size 1 M10x1,5  
 Thread Size 2 M10x1,5  
 reinforced version  
 replacement in pairs recommended



**References**

BMW 31 30 6 893 359  
 BMW (Brilliance) 31 30 6 893 359

BMW 6 893 359  
 BMW (Brilliance) 6 893 359

**Application info**

BMW 2 (G42) (08/21--)  
 BMW 4 (G22, G23, G26) (07/20--)

BMW 3 (G20, G21) (11/18--)  
 BMW i4 (G26) (11/21--)

**Stabilizer link**

**316 060 0098/HD**

**MSL1089HD**

**Notes**

Carbon Neutral  
 Coupling Rod  
 Front Axle Right  
 Length [mm] 282  
 Paired article number 316 060 0099/HD | MSL1090HD  
 Required quantity 1  
 Thread Size 1 M12x1,5  
 Thread Size 2 M12x1,5  
 reinforced version  
 replacement in pairs recommended





**References**

BMW 31 35 6 881 808

BMW 6 881 808

**Application info**

BMW X5 (G05) (08/18--)

BMW X6 (G06) (08/19--)

BMW X7 (G07) (03/19--)

BMW XM (G09) (12/22--)

**Stabilizer link**

316 060 0099/HD

MSL1090HD

**Notes**

Carbon Neutral

Coupling Rod

Front Axle Left

Length [mm]

282

Paired article number

316 060 0098/HD | MSL1089HD

Required quantity

1

Thread Size 1

M12x1,5

Thread Size 2

M12x1,5

reinforced version

replacement in pairs recommended



**References**

BMW 31 35 6 881 807

BMW 6 881 807

**Application info**

BMW X5 (G05) (08/18--)

BMW X6 (G06) (08/19--)

BMW X7 (G07) (03/19--)

BMW XM (G09) (12/22--)

**Stabilizer link**

316 060 0100/HD

MSL1155HD

**Notes**

Carbon Neutral

Coupling Rod

Rear Axle Left

Rear Axle Right

Steel

Length [mm]

140

Pipe Diameter [mm]

10

Required quantity

2

Thread Size 1

M12x1,5

reinforced version

replacement in pairs recommended



**References**

BMW 33 55 6 882 924

BMW 6 882 924

**Application info**

BMW 7 (G11, G12) (07/15--)

BMW X6 (G06) (08/19--)

BMW X5 (G05) (08/18--)

BMW X7 (G07) (03/19--)

**Stabilizer link****316 060 0101/HD****MSL1160HD****Notes**Carbon Neutral  
Coupling Rod  
Front Axle Left  
Steel

Length [mm]

391.5

Paired article number

316 060 0102/HD | MSL1161HD

Pipe Diameter [mm]

12

Required quantity

1

Thread Size 1

M10x1,5

Thread Size 2

M10x1,5

reinforced version

replacement in pairs recommended

**References**

BMW 31 30 6 886 279

Toyota 48820-WAA01

BMW 6 886 279

**Application info**

BMW Z4 Roadster (G29) (11/18--)

Toyota Supra V (\_A9\_) (03/19--)

**Stabilizer link****316 060 0102/HD****MSL1161HD****Notes**Carbon Neutral  
Coupling Rod  
Front Axle Right  
Steel

Length [mm]

391.5

Paired article number

316 060 0101/HD | MSL1160HD

Pipe Diameter [mm]

12

Required quantity

1

Thread Size 1

M10x1,5

Thread Size 2

M10x1,5

reinforced version

replacement in pairs recommended



**References**

BMW 31 30 6 886 280  
Toyota 48820-WAA02

BMW 6 886 280

**Application info**

BMW Z4 Roadster (G29) (11/18--)

Toyota Supra V (\_A9\_) (03/19--)

**Stabilizer link**

316 060 0103/HD

MSL1044HD

**Notes**

Carbon Neutral  
Coupling Rod  
Front Axle Left

Length [mm] 317  
Paired article number 316 060 0104/HD | MSL1045HD  
Required quantity 1  
Thread Size 1 M12x1,5  
Thread Size 2 M12x1,5  
reinforced version  
replacement in pairs recommended



**References**

BMW 31 35 6 881 091  
BMW 31 35 6 887 271  
BMW 6 886 035

BMW 31 35 6 886 035  
BMW 6 881 091  
BMW 6 887 271

**Application info**

BMW X3 (G01) (07/17--)  
BMW iX3 (09/20--)

BMW X4 (G02) (04/18--)

**Stabilizer link**

316 060 0104/HD

MSL1045HD

**Notes**

Carbon Neutral  
Coupling Rod  
Front Axle Right

Length [mm] 317  
Paired article number 316 060 0103/HD | MSL1044HD  
Required quantity 1  
Thread Size 1 M12x1,5  
Thread Size 2 M12x1,5  
reinforced version  
replacement in pairs recommended



**References**

BMW 31 35 6 881 092  
 BMW 31 35 6 887 272  
 BMW 6 886 036

BMW 31 35 6 886 036  
 BMW 6 881 092  
 BMW 6 887 272

**Application info**

BMW X3 (G01) (07/17--)  
 BMW iX3 (09/20--)

BMW X4 (G02) (04/18--)

**Stabilizer link**

316 060 0105/HD

MSL1114HD

**Notes**

Carbon Neutral  
 Coupling Rod  
 Rear Axle Left  
 Rear Axle Right

Length [mm] 136  
 Required quantity 2  
 Thread Size 1 M10x1,5  
 reinforced version  
 replacement in pairs recommended



**References**

BMW 33 55 6 870 702

BMW 6 870 702

**Application info**

BMW X3 (G01) (07/17--)  
 BMW iX3 (09/20--)

BMW X4 (G02) (04/18--)

**Stabilizer link**

316 060 0106/HD

MSL1047HD

**Notes**

Carbon Neutral  
 Coupling Rod  
 Front Axle Left  
 Front Axle Right

Length [mm] 180  
 Required quantity 2  
 Thread Size 1 M12x1,5  
 Thread Size 2 M12x1,5  
 reinforced version  
 replacement in pairs recommended



**References**

BMW 31 30 6 861 485

BMW 6 861 485

**Application info**

BMW 5 (G30, G31) (09/16--)

BMW 7 (G11, G12) (07/15--)

BMW 8 Gran Coupe (G16) (07/19--)

BMW 6 (G32) (06/17--)

BMW 8 (G15) (07/18--)

**Stabilizer link****316 060 0107/HD****MSL1025HD****Notes**Carbon Neutral  
Coupling Rod  
Front Axle Left  
Front Axle Right

Length [mm]

320

Required quantity

2

Thread Size 1

M10x1,5

Thread Size 2

M10x1,5

reinforced version

replacement in pairs recommended

**References**

Mini 31 30 6 862 863

Mini 6 862 863

**Application info**

Mini Mini III (09/13--)

**Stabilizer link****316 060 0108/HD****MSL1049HD****Notes**Carbon Neutral  
Coupling Rod  
Rear Axle Right

Length [mm]

155

Paired article number

316 060 0109/HD | MSL1050HD

Required quantity

1

Thread Size 1

M10x1,5

Thread Size 2

M10x1,5

reinforced version

replacement in pairs recommended

**References**

Mini 33 50 9 803 516



Mini 9 803 516



**Application info**

Mini Countryman I (08/10-10/16)



Mini Paceman (03/12-10/16)



Stabilizer link		316 060 0111/HD	MSL1126HD
<b>Notes</b>  Carbon Neutral Coupling Rod Front Axle Left  Length [mm] 235 Paired article number 316 060 0110/HD   MSL1125HD Required quantity 1 Thread Size 1 M10x1,5 Thread Size 2 M10x1,5 reinforced version replacement in pairs recommended			
<b>References</b> BMW 31 30 6 862 857 BMW 6 862 857			
<b>Application info</b> BMW i3 (08/13-- )			
Stabilizer link		316 060 0114	MSL1196
<b>Notes</b>  Coupling Rod Rear Axle Right  Length [mm] 97 Paired article number 316 060 0115   MSL1197 Required quantity 1 Thread Size 1 M10 x 1,5 Thread Size 2 M10 X 1,5 replacement in pairs recommended			
<b>References</b> BMW 33 50 6 888 790 BMW 6 888 790			
<b>Application info</b> BMW iX (I20) (07/21-- )			

Stabilizer link		316 060 0115	MSL1197
<p><b>Notes</b></p> <p>Coupling Rod Rear Axle Left</p> <p>Length [mm] 97</p> <p>Paired article number 316 060 0114   MSL1196</p> <p>Required quantity 1</p> <p>Thread Size 1 M10 x 1,5</p> <p>Thread Size 2 M10 x 1,5</p> <p>replacement in pairs recommended</p>			
<p><b>References</b></p> <p>BMW 33 50 6 888 789 BMW 6 888 789</p>			
<p><b>Application info</b></p> <p>BMW iX (I20) (07/21--)</p>			
Stabilizer link		316 060 0119/HD	MSL1198HD
<p><b>Notes</b></p> <p>Coupling Rod Rear Axle Left</p> <p>Length [mm] 94.5</p> <p>Paired article number 316 060 0120/HD   MSL1199HD</p> <p>Pipe Diameter [mm] 10</p> <p>Required quantity 1</p> <p>Thread Size 1 M10 x 1,5</p> <p>Thread Size 2 M10 X 1,5</p> <p>replacement in pairs recommended</p>			
<p><b>References</b></p> <p>BMW 33 50 6 895 143 BMW 6 895 143</p>			
<p><b>Application info</b></p> <p>BMW i4 (G26) (11/21--)</p>			



Stabilizer link		316 060 0120/HD	MSL1199HD
<b>Notes</b>  Coupling Rod Rear Axle Right Length [mm] 94.5 Paired article number 316 060 0119/HD   MSL1198HD Pipe Diameter [mm] 10 Required quantity 1 Thread Size 1 M10 x 1,5 Thread Size 2 M10 X 1,5 replacement in pairs recommended			
<b>References</b> BMW 33 50 6 895 144 BMW 6 895 144			
<b>Application info</b> BMW i4 (G26) (11/21-- )			
Stabilizer link		316 060 4311/HD	MSL0346HD
<b>Notes</b>  Carbon Neutral Coupling Rod Front Axle Left Front Axle Right with spanner attachment Inner Diameter 1 [mm] 8 Length [mm] 67 Required quantity 2 Thread Size 1 M10x1,5 reinforced version replacement in pairs recommended			
<b>References</b> BMW 1 091 764 BMW 1 127 689 BMW 1 128 737 BMW 31 35 1 091 764 BMW 31 35 1 127 689 BMW 31 35 1 128 737			
<b>Application info</b> BMW 3 (E30) (09/82-10/94) BMW 3 (E36) (09/90-08/00) BMW Z1 (06/88-06/91) BMW Z3 (E36/7, E36/8) (10/95-06/03)			

**Stabilizer link**

316 060 4322/HD

MSL0347HD

**Notes**

Carbon Neutral  
Coupling Rod  
Front Axle Left  
Front Axle Right  
with spanner attachment

Length [mm] 240  
Required quantity 2  
Thread Size 1 M10x1,5  
Thread Size 2 M10x1,5  
reinforced version  
replacement in pairs recommended



**References**

- |                     |                     |
|---------------------|---------------------|
| BMW 1 124 380       | BMW 1 127 194       |
| BMW 1 128 050       | BMW 1 130 075       |
| BMW 1 134 582       | BMW 31 35 1 124 380 |
| BMW 31 35 1 127 194 | BMW 31 35 1 128 050 |
| BMW 31 35 1 130 075 | BMW 31 35 1 134 582 |

**Application info**

- |                           |                           |
|---------------------------|---------------------------|
| BMW 3 (E30) (09/82-10/94) | BMW 3 (E36) (09/90-08/00) |
| BMW 5 (E28) (05/81-12/87) | BMW 5 (E34) (02/87-07/96) |
| BMW 6 (E24) (10/75-04/89) | BMW 7 (E32) (03/85-10/94) |
| BMW 8 (E31) (01/90-12/99) |                           |

**Stabilizer link**

316 060 4358/HD

MSL0348HD

**Notes**

Carbon Neutral  
Coupling Rod  
Front Axle Right  
with spanner attachment

Length [mm] 240  
Paired article number 316 060 4359/HD | MSL0349HD  
Required quantity 1  
Thread Size 1 M10x1,5  
Thread Size 2 M10x1,5  
reinforced version  
replacement in pairs recommended



**References**

BMW 1 091 856

BMW 31 35 1 091 856

BMW 1 095 662

BMW 31 35 1 095 662

**Application info**

BMW 5 (E39) (09/95-06/04)

**Stabilizer link**

316 060 4359/HD

MSL0349HD

**Notes**

Carbon Neutral  
Coupling Rod  
Front Axle Left  
with spanner attachment

240

316 060 4358/HD | MSL0348HD

1

M10x1,5

M10x1,5

Length [mm]

Paired article number

Required quantity

Thread Size 1

Thread Size 2

reinforced version

replacement in pairs recommended

**References**

BMW 1 091 855

BMW 31 35 1 091 855

BMW 1 095 661

BMW 31 35 1 095 661

**Application info**

BMW 5 (E39) (09/95-06/04)

**Stabilizer link**

316 060 4364/HD

MSL0350HD

**Notes**

Carbon Neutral  
Coupling Rod  
Front Axle Left  
Front Axle Right  
with spanner attachment

308

2

M10x1,5

M10x1,5

Length [mm]

Required quantity

Thread Size 1

Thread Size 2

reinforced version

replacement in pairs recommended



**References**

BMW 1 091 496

BMW 31 35 1 091 496

BMW 1 095 695

BMW 31 35 1 095 695

**Application info**

BMW 7 (E38) (03/94-11/01)

BMW Z8 (E52) (01/00-12/03)

**Stabilizer link**

316 060 4365/HD

MSL0351HD

**Notes**

Carbon Neutral  
Coupling Rod  
Rear Axle Left  
Rear Axle Right  
with spanner attachment

Length [mm]

77

Required quantity

2

Thread Size 1

M10x1,5

Thread Size 2

M10x1,5

reinforced version

replacement in pairs recommended



**References**

BMW 1 091 497

BMW 33 55 1 091 497

BMW 1 095 696

BMW 33 55 1 095 696

**Application info**

BMW 7 (E38) (03/94-11/01)

BMW Z8 (E52) (01/00-12/03)

**Stabilizer link**

316 060 4607/HD

MSL0352HD

**Notes**

Carbon Neutral  
Coupling Rod  
Front Axle Left  
Front Axle Right  
with spanner attachment

Length [mm]

270

Required quantity

2

Thread Size 1

M10x1,5

Thread Size 2

M10x1,5

reinforced version

replacement in pairs recommended



**References**

BMW 1 095 694

BMW 31 35 1 095 694

BMW 31 35 6 780 847

BMW (Brilliance) 1 095 694

BMW (Brilliance) 31 35 6 780 847

BMW 2 241 254

BMW 31 35 2 241 254

BMW 6 780 847

BMW (Brilliance) 31 35 1 095 694

BMW (Brilliance) 6 780 847

**Application info**

BMW 3 (E46) (12/97-12/07)

BMW Z4 (E86) (03/06-01/09)

BMW Z4 (E85) (09/02-12/09)

**Stabilizer link****32-16 060 0005****MSL0356****Notes**

Coupling Rod

Length [mm]

60

Required quantity

2

Thread Size 1

M10x1,25

Thread Size 2

M10x1,25

replacement in pairs recommended

**References**

Hyundai MB518892

Mitsubishi MB518892

Mitsubishi MB892982

Mitsubishi 4056A014

Mitsubishi MB573043

**Application info**

Hyundai Pony (X-2) (04/89-01/95)

Mitsubishi 3000 GT (06/89-08/00)

Mitsubishi Galant IV (11/87-03/93)

Mitsubishi Lancer IV (04/88-12/97)



Mitsubishi Sigma (10/90-10/96)



Hyundai S Coupé (02/90-05/96)



Mitsubishi Eclipse II (04/94-04/99)

Mitsubishi Galant V (11/92-12/98)

Mitsubishi Pajero Pinin (H60) (01/99-06/07)

Stabilizer link		32-16 060 0024	MSL0368
<p><b>Notes</b></p> <p>Coupling Rod Front Axle Left Front Axle Right</p> <p>Length [mm] 93 Required quantity 2 Thread Size 1 M10x1,25 Thread Size 2 M10x1,25 replacement in pairs recommended</p>			
<p><b>References</b></p> <p>Mitsubishi 4056A040 Mitsubishi MR476595</p>		<p>Mitsubishi MR319147</p>	
<p><b>Application info</b></p> <p>Mitsubishi Outlander I (03/01-07/08)</p>			
Stabilizer link		32-16 060 0032/HD	MSL0610HD
<p><b>Notes</b></p> <p>Carbon Neutral Coupling Rod Front Axle Right with spanner attachment</p> <p>Length [mm] 273.5 Paired article number 32-16 060 0033/HD   MSL0611HD Required quantity 1 Thread Size 1 M12x1,5 Thread Size 2 M12X1,5 reinforced version replacement in pairs recommended</p>			
<p><b>References</b></p> <p>Mitsubishi MR594340</p>			
<p><b>Application info</b></p> <p>Mitsubishi Grandis (03/03-12/11)</p>			

Stabilizer link		32-16 060 0033/HD	MSL0611HD
<b>Notes</b>  Carbon Neutral Coupling Rod Front Axle Left with spanner attachment  Length [mm] 273.5 Paired article number 32-16 060 0032/HD   MSL0610HD Required quantity 1 Thread Size 1 M12X1,5 Thread Size 2 M12X1,5 reinforced version replacement in pairs recommended			
<b>References</b> Mitsubishi MR594339			
<b>Application info</b> Mitsubishi Grandis (03/03-12/11)			
Stabilizer link		32-16 060 0037/HD	MSL1145HD
<b>Notes</b>  Carbon Neutral Coupling Rod Front Axle Left  Length [mm] 80 Paired article number Required quantity 1 Thread Size 1 M14x1,5 reinforced version replacement in pairs recommended			
<b>References</b> Fiat 6000605889 Mitsubishi 4056A198			
<b>Application info</b> Fiat Fullback Pick Up (01/16--) Mitsubishi Pajero Sport III (KS) (08/15--) Mitsubishi L200 V (11/14--)			

Stabilizer link		32-16 060 0038/HD	MSL1146HD
<p><b>Notes</b></p> <p>Carbon Neutral Coupling Rod Front Axle Right</p> <p>Length [mm] 80 Paired article number 32-16 060 0037/HD   MSL1145HD Required quantity 1 Thread Size 1 M14x1,5 reinforced version replacement in pairs recommended</p>			
<p><b>References</b></p> <p>Fiat 6000605890</p>		<p>Mitsubishi 4056A199</p>	
<p><b>Application info</b></p> <p>Fiat Fullback Pick Up (01/16--) Mitsubishi Pajero Sport III (KS) (08/15--)</p>		<p>Mitsubishi L200 V (11/14--)</p>	
Stabilizer link		33-16 060 0000	MSL0371
<p><b>Notes</b></p> <p>Coupling Rod Front Axle Left Front Axle Right</p> <p>Length [mm] 93 Required quantity 2 Thread Size 1 M10x1,25 Thread Size 2 M10x1,25 replacement in pairs recommended</p>			
<p><b>References</b></p> <p>Suzuki 42420-81A10</p>			
<p><b>Application info</b></p> <p>Suzuki Jimny I (SN) (01/98--)</p>			



**Stabilizer link**

33-16 060 0005/HD

MSL0374HD

**Notes**

Carbon Neutral  
Coupling Rod  
Front Axle Left  
Front Axle Right  
with spanner attachment

Length [mm] 300  
Required quantity 2  
Thread Size 1 M10x1,5  
Thread Size 2 M10x1,5  
reinforced version  
replacement in pairs recommended

**References**

Suzuki 42420-65J00

**Application info**

Suzuki Grand Vitara II (JB) (04/05--)

**Stabilizer link**

33-16 060 0006/HD

MSL0375HD

**Notes**

Carbon Neutral  
Coupling Rod  
Front Axle Left  
Front Axle Right  
with spanner attachment

Length [mm] 300  
Required quantity 2  
Thread Size 1 M10x1,5  
Thread Size 2 M10x1,5  
reinforced version  
replacement in pairs recommended

**References**

GENERAL MOTORS 93195093

Suzuki 42420-62J00

Vauxhall 47 09 702

Opel 47 09 702

Suzuki 42420-63J00

**Application info**

Opel Agila B (04/08-10/14)

Suzuki Swift III (02/05--)

Suzuki Splash (01/08--)

Vauxhall Agila Mk II (01/08-11/14)

## Stabilizer link

33-16 060 0007/HD

MSL0376HD

## Notes

Carbon Neutral  
Coupling Rod  
Front Axle Left  
Front Axle Right  
with spanner attachment

Length [mm]

270

Required quantity

2

Thread Size 1

M10x1,5

Thread Size 2

M10x1,5

reinforced version

replacement in pairs recommended



## References

Suzuki 42420-58M00

Suzuki 42420-59J00

Suzuki 42420-59J00-M

## Application info

Suzuki Celerio (02/14--)

Suzuki Liana (06/01--)

## Stabilizer link

33-16 060 0010

MSL0838

## Notes

Coupling Rod  
Front Axle Left  
Front Axle Right  
with spanner attachment

Length [mm]

300

Required quantity

2

Thread Size 1

M10x1,5

Thread Size 2

M10x1,5

replacement in pairs recommended





## References

Suzuki 42420-65J00

## Application info

Suzuki Grand Vitara II (JB) (04/05--)

Stabilizer link		33-16 060 0011	MSL0839
<b>Notes</b>  Coupling Rod Front Axle Left Front Axle Right with spanner attachment  Length [mm] 300 Required quantity 2 Thread Size 1 M10x1,5 Thread Size 2 M10x1,5 replacement in pairs recommended			
<b>References</b> GENERAL MOTORS 93195093 Opel 47 09 702 Suzuki 42420-62J00 Suzuki 42420-63J00 Vauxhall 47 09 702			
<b>Application info</b> Opel Agila B (04/08-10/14) Suzuki Splash (01/08--) Suzuki Swift III (02/05--) Vauxhall Agila Mk II (01/08-11/14)			
Stabilizer link		33-16 060 0012	MSL0840
<b>Notes</b>  Coupling Rod Front Axle Left Front Axle Right with spanner attachment  Length [mm] 270 Required quantity 2 Thread Size 1 M10x1,5 Thread Size 2 M10x1,5 replacement in pairs recommended			
<b>References</b> Suzuki 42420-58M00 Suzuki 42420-59J00 Suzuki 42420-59J00-M			
<b>Application info</b> Suzuki Celerio (02/14--) Suzuki Liana (06/01--)			

**Stabilizer link**

33-16 060 0015/HD

MSL1074HD

**Notes**

Carbon Neutral  
Coupling Rod  
Front Axle Left  
Front Axle Right

Length [mm]

350

Required quantity

2

Thread Size 1

M10 X 1,25

Thread Size 2

M10 X 1,25

reinforced version

replacement in pairs recommended

**References**

Suzuki 42420-53R00

Suzuki 42420-53R01

**Application info**

Suzuki Swift V (01/17--)

**Stabilizer link**

33-16 060 0017/HD

MSL1135HD

**Notes**

Carbon Neutral  
Coupling Rod  
Front Axle Left  
Front Axle Right

Length [mm]

350

Required quantity

2

Thread Size 1

M10x1,5

Thread Size 2

M10x1,5

reinforced version

replacement in pairs recommended

**References**

Suzuki 42420M68P00

**Application info**

Suzuki Baleno II (02/16--)

**Stabilizer link****34-16 060 0003/HD****MSL0380HD****Notes**

Carbon Neutral  
Coupling Rod  
Front Axle Left  
Front Axle Right

Length [mm]

60

Required quantity

2

Thread Size 1

M10x1,5

Thread Size 2

M10x1,5

reinforced version

replacement in pairs recommended

**References**

Subaru 20470FE000

Subaru 20470SA000

Subaru 20470SA001

**Application info**

Subaru Forester II (SG) (02/02-12/12)

Subaru Forester III (SH) (12/07--)

Subaru Impreza II (GD, GG) (09/99-06/09)

Subaru Impreza III (GR) (01/07--)

Subaru Impreza IV (GP, GJ) (07/11--)

Subaru Legacy IV (09/03-12/15)

Subaru Outback III (BL, BP) (09/03-06/10)

Subaru XV I (09/11--)

**Stabilizer link****34-16 060 0004/HD****MSL0381HD****Notes**

Carbon Neutral  
Coupling Rod  
Rear Axle Left  
Rear Axle Right  
with spanner attachment

Length [mm]

70

Required quantity

2

Thread Size 1

M10x1,5

Thread Size 2

M10x1,5

reinforced version

replacement in pairs recommended

**References**

Subaru 20470SA010

Subaru 20470SA011

**Application info**

Subaru Forester II (SG) (02/02-12/12)

Subaru Impreza II (GD, GG) (09/99-06/09)

**Stabilizer link**

34-16 060 0005

MSL0842

**Notes**

	Coupling Rod
	Front Axle Left
	Front Axle Right
Length [mm]	60
Required quantity	2
Thread Size 1	M10x1,5
Thread Size 2	M10x1,5
replacement in pairs recommended	

**References**

Subaru 20470FE000	Subaru 20470SA000
Subaru 20470SA001	

**Application info**

Subaru Forester II (SG) (02/02-12/12)	Subaru Forester III (SH) (12/07--)
Subaru Impreza II (GD, GG) (09/99-06/09)	Subaru Impreza III (GR) (01/07--)
Subaru Impreza IV (GP, GJ) (07/11--)	Subaru Legacy IV (09/03-12/15)
Subaru Outback III (BL, BP) (09/03-06/10)	Subaru XV I (09/11--)

**Stabilizer link**

34-16 060 0007

MSL0991

**Notes**



	Coupling Rod
	Front Axle Left
Length [mm]	315
Paired article number	34-16 060 0008   MSL0992
Required quantity	1
Thread Size 1	12x1,25
Thread Size 2	12x1,25
replacement in pairs recommended	

**References**

Subaru 20420FL030
-------------------

**Application info**

Subaru XV II (04/17--)
------------------------

Stabilizer link		34-16 060 0008	MSL0992
<b>Notes</b>  Coupling Rod Front Axle Right  Length [mm] 315 Paired article number 34-16 060 0007   MSL0991 Required quantity 1 Thread Size 1 12x1,25 Thread Size 2 12x1,25 replacement in pairs recommended			
<b>References</b> Subaru 20420FL020			
<b>Application info</b> Subaru XV II (04/17-- )			
Stabilizer link		34-16 060 0009/HD	MSL1170HD
<b>Notes</b>  Carbon Neutral Coupling Rod Rear Axle Left  Length [mm] 112.4 Paired article number 34-16 060 0010/HD   MSL1171HD Required quantity 1 Thread Size 1 M10X1,25 Thread Size 2 M10X1,25 reinforced version replacement in pairs recommended			
<b>References</b> Subaru 20470FL010			
<b>Application info</b> Subaru Forester V (SK) (04/18-- ) Subaru XV II (04/17-- ) Subaru Impreza V (GT) (10/16-- )			

**Stabilizer link****34-16 060 0010/HD****MSL1171HD****Notes**

Carbon Neutral  
Coupling Rod  
Rear Axle Right

Length [mm] 112.4  
Paired article number 34-16 060 0009/HD | MSL1170HD  
Required quantity 1  
Thread Size 1 M10X1,25  
Thread Size 2 M10X1,25  
reinforced version  
replacement in pairs recommended

**References**

Subaru 20470FL000

**Application info**

Subaru Forester V (SK) (04/18--)  
Subaru XV II (04/17--)

Subaru Impreza V (GT) (10/16--)

**Stabilizer link****34-16 060 0011/HD****MSL1189HD****Notes**

Coupling Rod  
Rear Axle Left  
Rear Axle Right

Length [mm] 107  
Required quantity 2  
Thread Size 1 M10x1,5  
reinforced version  
replacement in pairs recommended

**References**

Subaru 20470AJ010

Subaru 20470SC000

**Application info**

Subaru Forester III (SH) (12/07--)  
Subaru Impreza IV (GP, GJ) (07/11--)  
Subaru Outback IV (BM, BR) (06/09--)  
Subaru XV I (09/11--)

Subaru Forester IV (SJ) (11/12--)  
Subaru Legacy V (06/08--)  
Subaru Outback V (10/14--)



**Stabilizer link****34-16 060 0012/HD****MSL1172HD****Notes**

Carbon Neutral  
Coupling Rod  
Front Axle Left  
Front Axle Right

Length [mm] 71  
Required quantity 2  
Stabiliser Diameter [mm] 10  
Thread Size 1 M12X1,5  
Thread Size 2 M12X1,5  
reinforced version  
replacement in pairs recommended

**References**

Subaru 20420XA000

**Application info**

Subaru Forester IV (SJ) (11/12--)  
Subaru Levorg (03/15--)  
Subaru Tribeca (B9) (01/05--)  
Subaru XV I (09/11--)

Subaru Forester V (SK) (04/18--)  
Subaru Outback IV (BM, BR) (06/09--)  
Subaru WRX (GP,GJ) (07/11-12/12)

**Stabilizer link****34-16 060 0013/HD****MSL1184HD****Notes**

Carbon Neutral  
Coupling Rod  
Front Axle Left

Length [mm] 341  
Paired article number 34-16 060 0014/HD | MSL1185HD  
Required quantity 1  
Thread Size 1 M12X1,5  
Thread Size 2 M12X1,5  
replacement in pairs recommended

**References**





Subaru 20420AL010



Subaru 20420AL011

**Application info**

Subaru Legacy VI (BN, BS) (01/15--)

Subaru Outback V (10/14--)

Stabilizer link		34-16 060 0014/HD	MSL1185HD		
<b>Notes</b>					
	Carbon Neutral				
	Coupling Rod				
	Front Axle Right				
Length [mm]	341				
Paired article number	34-16 060 0013/HD   MSL1184HD				
Required quantity	1				
Thread Size 1	M12X1,5				
Thread Size 2	M12X1,5				
reinforced version					
replacement in pairs recommended					
<b>References</b>					
Subaru 20420AL000				Subaru 20420AL001	
<b>Application info</b>					
Subaru Legacy VI (BN, BS) (01/15--)				Subaru Outback V (10/14--)	
Stabilizer link				35-16 060 0000/HD	MSL0382HD
<b>Notes</b>					
	Carbon Neutral				
	Coupling Rod				
	Rear Axle Left				
	Rear Axle Right				
	with spanner attachment				
Length [mm]	190				
Required quantity	2				
Thread Size 1	M10x1,5				
Thread Size 2	M10x1,5				
reinforced version					
replacement in pairs recommended					
<b>References</b>					
Mazda B26R-28-170					
<b>Application info</b>					
Mazda 323 (BJ) (05/98-05/04)				Mazda Premacy (01/99-06/05)	

Stabilizer link		35-16 060 0001	MSL0383												
<p><b>Notes</b></p> <p>Coupling Rod Front Axle Left</p> <p>Length [mm] 105</p> <p>Paired article number 35-16 060 0002   MSL0384</p> <p>Required quantity 1</p> <p>Thread Size 1 M10x1,25</p> <p>Thread Size 2 M10x1,25</p> <p>replacement in pairs recommended</p>															
<p><b>References</b></p> <table border="0"> <tr> <td>Ford 3 410 592</td> <td>Ford GA2A-34170-A</td> </tr> <tr> <td>Kia KGA2A 34170</td> <td>Kia KGA2A 34170A</td> </tr> <tr> <td>Kia KGA2A 34170B</td> <td>Kia KGA2A 34170BAS</td> </tr> <tr> <td>Mazda F151-34-170</td> <td>Mazda F189-34-170</td> </tr> <tr> <td>Mazda GA2A-34-170</td> <td>Mazda GA2A-34-170A</td> </tr> <tr> <td>Mazda L206-34-170A</td> <td>Toyota L2063-4170A</td> </tr> </table>				Ford 3 410 592	Ford GA2A-34170-A	Kia KGA2A 34170	Kia KGA2A 34170A	Kia KGA2A 34170B	Kia KGA2A 34170BAS	Mazda F151-34-170	Mazda F189-34-170	Mazda GA2A-34-170	Mazda GA2A-34-170A	Mazda L206-34-170A	Toyota L2063-4170A
Ford 3 410 592	Ford GA2A-34170-A														
Kia KGA2A 34170	Kia KGA2A 34170A														
Kia KGA2A 34170B	Kia KGA2A 34170BAS														
Mazda F151-34-170	Mazda F189-34-170														
Mazda GA2A-34-170	Mazda GA2A-34-170A														
Mazda L206-34-170A	Toyota L2063-4170A														
<p><b>Application info</b></p> <table border="0"> <tr> <td>Kia Clarus (05/96--)</td> <td>Mazda 323 (BA) (09/92-12/03)</td> </tr> <tr> <td>Mazda 626 (GE) (08/91-08/98)</td> <td>Mazda 626 (GF, GW) (05/97-12/02)</td> </tr> <tr> <td>Mazda 929 (HB, HC, HV) (12/81-08/91)</td> <td>Mazda CX-7 (ER) (06/06-12/14)</td> </tr> <tr> <td>Mazda MX-5 (NC) (03/05-12/14)</td> <td>Mazda MX-6 (GE) (07/91-09/97)</td> </tr> <tr> <td>Mazda RX-8 (10/03-06/12)</td> <td>Mazda Xedos 6 (01/92-10/99)</td> </tr> </table>				Kia Clarus (05/96--)	Mazda 323 (BA) (09/92-12/03)	Mazda 626 (GE) (08/91-08/98)	Mazda 626 (GF, GW) (05/97-12/02)	Mazda 929 (HB, HC, HV) (12/81-08/91)	Mazda CX-7 (ER) (06/06-12/14)	Mazda MX-5 (NC) (03/05-12/14)	Mazda MX-6 (GE) (07/91-09/97)	Mazda RX-8 (10/03-06/12)	Mazda Xedos 6 (01/92-10/99)		
Kia Clarus (05/96--)	Mazda 323 (BA) (09/92-12/03)														
Mazda 626 (GE) (08/91-08/98)	Mazda 626 (GF, GW) (05/97-12/02)														
Mazda 929 (HB, HC, HV) (12/81-08/91)	Mazda CX-7 (ER) (06/06-12/14)														
Mazda MX-5 (NC) (03/05-12/14)	Mazda MX-6 (GE) (07/91-09/97)														
Mazda RX-8 (10/03-06/12)	Mazda Xedos 6 (01/92-10/99)														
Stabilizer link		35-16 060 0002	MSL0384												
<p><b>Notes</b></p> <p>Coupling Rod Front Axle Right</p> <p>Length [mm] 105</p> <p>Paired article number 35-16 060 0001   MSL0383</p> <p>Required quantity 1</p> <p>Thread Size 1 M10x1,25</p> <p>Thread Size 2 M10x1,25</p> <p>replacement in pairs recommended</p>															

**References**

Ford 3 410 591	Ford 35-16 060 0002
Kia KGA2A 34150	Kia KGA2A 34150A
Kia KGA2A 34150B	Kia KGA2A 34150BAS
Mazda F151-34-150	Mazda F189-34-150
Mazda GA2A-34-150	Mazda GA2A-34-150A
Mazda L206-34-150A	

**Application info**

Kia Clarus (05/96--)	Mazda 323 (BA) (09/92-12/03)
Mazda 626 (GE) (08/91-08/98)	Mazda 626 (GF, GW) (05/97-12/02)
Mazda 929 (HB, HC, HV) (12/81-08/91)	Mazda CX-7 (ER) (06/06-12/14)
Mazda MX-5 (NC) (03/05-12/14)	Mazda MX-6 (GE) (07/91-09/97)
Mazda RX-8 (10/03-06/12)	Mazda Xedos 6 (01/92-10/99)

**Stabilizer link**

35-16 060 0005/HD

MSL0386HD

**Notes**

Carbon Neutral  
Coupling Rod  
Front Axle Left  
Front Axle Right  
with spanner attachment

Length [mm] 190  
Required quantity 2  
Thread Size 1 M10x1,5  
Thread Size 2 M10x1,5  
reinforced version  
replacement in pairs recommended





**References**

Mazda B26R-34-170

**Application info**

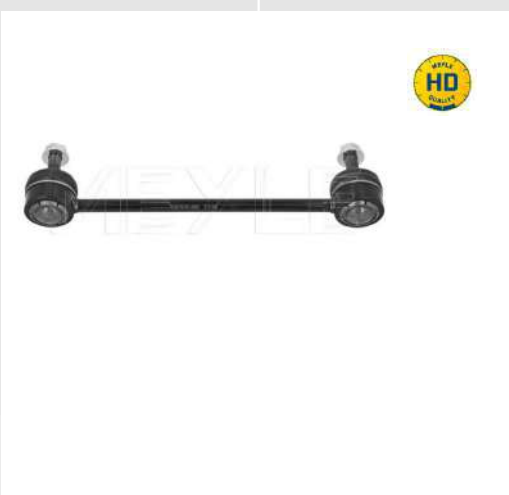
Mazda 323 (BJ) (05/98-05/04)	Mazda Premacy (01/99-06/05)
------------------------------	-----------------------------

Stabilizer link		35-16 060 0011/HD	MSL0389HD
<b>Notes</b>  Carbon Neutral Coupling Rod Rear Axle Left Rear Axle Right with spanner attachment  Length [mm] 230 Required quantity 2 Thread Size 1 M10x1,5 Thread Size 2 M10x1,5 reinforced version replacement in pairs recommended			
<b>References</b> Mazda GA20-28-170B Mazda GE4T-12-8170 Mazda GE4T-28-170			
<b>Application info</b> Mazda 626 (GF, GW) (05/97-12/02)			
Stabilizer link		35-16 060 0012	MSL0390
<b>Notes</b>  Coupling Rod Front Axle Left Front Axle Right  Length [mm] 300 Required quantity 2 Thread Size 1 M10x1,25 Thread Size 2 M10x1,25 replacement in pairs recommended			
<b>References</b> Mazda B39D-34-170 Mazda BBM2-34 170 Mazda BBM2-34-170A			
<b>Application info</b> Mazda 3 (BL) (12/08-12/14)			

**Stabilizer link****35-16 060 0014/HD****MSL0391HD****Notes**

Carbon Neutral  
Coupling Rod  
Rear Axle Left  
Rear Axle Right  
with spanner attachment

Length [mm]

80

Required quantity

2

Thread Size 1

M10x1,5

Thread Size 2

M10x1,5

reinforced version

replacement in pairs recommended

**References**

Fiat 50704671

Mazda EA01-28 170C

Mazda EA01-28-170A

Mazda EA01-28-170D

Fiat 51856959

Mazda EA01-28-170

Mazda EA01-28-170B

**Application info**

Fiat Panda II (09/03--)

Mazda MX-3 (EC) (05/91-09/98)

**Stabilizer link****35-16 060 0015/HD****MSL0392HD****Notes**

Carbon Neutral  
Coupling Rod  
Front Axle Left  
Front Axle Right  
with spanner attachment

Length [mm]

265

Required quantity

2

Thread Size 1

M10x1,5

Thread Size 2

M10x1,5

reinforced version

replacement in pairs recommended



**References**

Chrysler 05174185AA  
 Chrysler 05174185AC  
 Chrysler 5174185AB  
 Daewoo 96300627  
 Dodge 5174185AB  
 Fiat K05174185AC  
 Jeep 5174185AC  
 Mazda LC62-34-170A

Chrysler 05174185AB  
 Chrysler 5174185AA  
 Chrysler 5174185AC  
 Dodge 5174185AA  
 Dodge 5174185AC  
 Jeep 5174185AB  
 Mazda LC62-34-170  
 Mazda LC62-34-170B

**Application info**

Chrysler Sebring (JS) (09/06-12/10)  
 Jeep Compass (MK) (08/06--)  
 Mazda 323 (BJ) (05/98-05/04)  
 Mazda MPV II (LW) (08/99-12/06)

Daewoo Nubira (KLAJ) (04/97--)  
 Jeep Patriot (MK) (02/07-12/17)  
 Mazda MPV I (LV) (09/88-09/99)  
 Mazda Premacy (01/99-06/05)

**Stabilizer link****35-16 060 0017****MSL0393****Notes**

Coupling Rod  
 Rear Axle Left  
 Rear Axle Right



Length [mm] 95  
 Required quantity 2  
 Thread Size 1 M10x1,25  
 Thread Size 2 M10x1,25  
 replacement in pairs recommended

**References**



Mazda GS1D-28-170

**Application info**

Mazda 6 (GH) (08/07-12/13)

Stabilizer link		35-16 060 0018/HD	MSL0394HD
<b>Notes</b>  Carbon Neutral Coupling Rod Front Axle Left with spanner attachment  Length [mm] 155 Paired article number 35-16 060 0020/HD   MSL0396HD Required quantity 1 Thread Size 1 M10x1,5 Thread Size 2 M10x1,5 reinforced version replacement in pairs recommended			
<b>References</b> Mazda GJ6A-34-170A Mazda GK2A-34 170 Mazda GS1D-34-170			
<b>Application info</b> Mazda 6 (GG, GY) (01/02-12/08) Mazda 6 (GH) (08/07-12/13)			
Stabilizer link		35-16 060 0019/HD	MSL0395HD
<b>Notes</b>  Carbon Neutral Coupling Rod Rear Axle Left Rear Axle Right with spanner attachment  Length [mm] 77 Required quantity 2 Thread Size 1 M10x1,5 reinforced version replacement in pairs recommended			
<b>References</b> Mazda GJ6A-28-170 Mazda GJ6A-28-170A Mazda GJ6A-28-170B Mazda GJ6A-30-170B			
<b>Application info</b> Mazda 6 (GG, GY) (01/02-12/08)			



Stabilizer link		35-16 060 0020/HD	MSL0396HD
<b>Notes</b>  Carbon Neutral Coupling Rod Front Axle Right with spanner attachment  Length [mm] 155 Paired article number 35-16 060 0018/HD   MSL0394HD Required quantity 1 Thread Size 1 M10x1,5 Thread Size 2 M10x1,5 reinforced version replacement in pairs recommended			
<b>References</b> Mazda GJ6A-34-150A Mazda GK2A-34 150A Mazda GS1D-34-150			
<b>Application info</b> Mazda 6 (GG, GY) (01/02-12/08) Mazda 6 (GH) (08/07-12/13)			
Stabilizer link		35-16 060 0021/HD	MSL0397HD
<b>Notes</b>  Carbon Neutral Coupling Rod Front Axle Rear Axle with spanner attachment  Length [mm] 250 Required quantity 2 Thread Size 1 M10x1,5 Thread Size 2 M10x1,5 reinforced version replacement in pairs recommended			

**References**

Ford 1 513 343	Ford 1 745 924
Ford 1 790 310	Ford 1 905 043
Ford 2 033 497	Ford 2 069 658
Ford 2 513 086	Ford 3L84-3052-AA
Ford 4 049 981	Ford 4 133 885
Ford 4 462 153	Ford 4 487 771
Ford 4 562 792	Ford 4 779 527
Ford 5 096 832	Ford 5L84-5K483-AB
Ford 5L84-5K483-AC	Ford 7L84-5K483-AA
Ford 7L84-5K483-AB	Ford 8V51-3B438-AB
Ford 8V51-3B438-BA	Ford 8V51-3B438-BB
Ford 8V51-3B438-BC	Ford 8V51-3B438-BD
Ford ME8V5J-3B438-BD	Ford YL84-3052-AA
Mazda BC1D-28-170	Mazda BC1D-28-170A
Mazda D651-34-170	Mazda D651-34-170A
Mazda EF91-34-150	Mazda EF91-34-150A
Mazda EF91-34-150B	Mazda EF91-34-150C
Mazda EF91-34-150D	Mazda ZZC0-34-150
Mazda ZZC0-34-150A	Nissan 54618-9U00A
Nissan 54618-AX600	Nissan 54618-BC40A
Renault 551100748R	Renault 551107041R
Renault 551107916R	Renault 551108147R
Renault 8200127308	Renault 8200605381
Renault 8201079463	

**Application info**

Ford B-MAX (08/12--)	Ford Ecosport (09/11--)
Ford Fiesta VI (06/08--)	Ford Fiesta VII (05/17--)
Ford KA III (08/14--)	Ford Puma (09/19--)
Ford Tourneo '14 (02/14--)	Ford Transit Courier '14 (02/14--)
Mazda 2 (DE) (07/07-06/15)	Mazda 323 (BA) (09/92-12/03)
Nissan Micra (K12) (03/02--)	Nissan Note I (01/05-08/13)
Renault Captur I (06/13--)	Renault Clio III / Modus (09/04--)
Renault Clio IV (11/12--)	Renault Zoe (06/12--)

**Stabilizer link**

35-16 060 0022/HD

MSL0398HD

**Notes**

Carbon Neutral  
Coupling Rod  
Front Axle Left  
Front Axle Right  
with spanner attachment

Length [mm]

325

Required quantity

2

Thread Size 1

M10x1,5

Thread Size 2

M10x1,5

reinforced version

replacement in pairs recommended

**References**

Mazda LC70-34-170

**Application info**

Mazda MPV II (LW) (08/99-12/06)

**Stabilizer link**

35-16 060 0025/HD

MSL0399HD

**Notes**

Carbon Neutral  
Coupling Rod  
Rear Axle Left  
Rear Axle Right  
with spanner attachment

Length [mm]

160

Required quantity

2

Thread Size 1

M10x1,5

Thread Size 2

M10x1,5

reinforced version

replacement in pairs recommended



**References**

Mazda B30H-28-170B

**Application info**

Mazda 323 (BJ) (05/98-05/04)

Mazda Premacy (01/99-06/05)

Stabilizer link		35-16 060 0026	MSL0400
<b>Notes</b>  Coupling Rod Front Axle Right  Length [mm] 105 Paired article number 35-16 060 0027   MSL0401 Required quantity 1 Thread Size 1 M10x1,25 Thread Size 2 M10x1,25 replacement in pairs recommended			
<b>References</b> Mazda NC10-34-150			
<b>Application info</b> Mazda MX-5 (NB) (01/98-10/05)			
Stabilizer link		35-16 060 0027	MSL0401
<b>Notes</b>  Coupling Rod Front Axle Left  Length [mm] 105 Paired article number 35-16 060 0026   MSL0400 Required quantity 1 Thread Size 1 M10x1,25 Thread Size 2 M10x1,25 replacement in pairs recommended			
<b>References</b> Mazda NC10-34-170			
<b>Application info</b> Mazda MX-5 (NB) (01/98-10/05)			

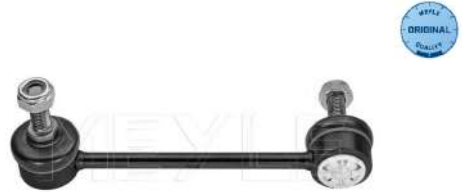
Stabilizer link		35-16 060 0035	MSL0847																
<p><b>Notes</b></p> <p>Coupling Rod Front Axle Left Front Axle Right with spanner attachment</p> <p>Length [mm] 265 Required quantity 2 Thread Size 1 M10x1,5 Thread Size 2 M10x1,5 replacement in pairs recommended</p>																			
<p><b>References</b></p> <table border="0"> <tr> <td>Chrysler 05174185AA</td> <td>Chrysler 05174185AB</td> </tr> <tr> <td>Chrysler 05174185AC</td> <td>Chrysler 5174185AA</td> </tr> <tr> <td>Chrysler 5174185AB</td> <td>Chrysler 5174185AC</td> </tr> <tr> <td>Daewoo 96300627</td> <td>Dodge 5174185AA</td> </tr> <tr> <td>Dodge 5174185AB</td> <td>Dodge 5174185AC</td> </tr> <tr> <td>Fiat K05174185AC</td> <td>Jeep 5174185AB</td> </tr> <tr> <td>Jeep 5174185AC</td> <td>Mazda LC62-34-170</td> </tr> <tr> <td>Mazda LC62-34-170A</td> <td>Mazda LC62-34-170B</td> </tr> </table>				Chrysler 05174185AA	Chrysler 05174185AB	Chrysler 05174185AC	Chrysler 5174185AA	Chrysler 5174185AB	Chrysler 5174185AC	Daewoo 96300627	Dodge 5174185AA	Dodge 5174185AB	Dodge 5174185AC	Fiat K05174185AC	Jeep 5174185AB	Jeep 5174185AC	Mazda LC62-34-170	Mazda LC62-34-170A	Mazda LC62-34-170B
Chrysler 05174185AA	Chrysler 05174185AB																		
Chrysler 05174185AC	Chrysler 5174185AA																		
Chrysler 5174185AB	Chrysler 5174185AC																		
Daewoo 96300627	Dodge 5174185AA																		
Dodge 5174185AB	Dodge 5174185AC																		
Fiat K05174185AC	Jeep 5174185AB																		
Jeep 5174185AC	Mazda LC62-34-170																		
Mazda LC62-34-170A	Mazda LC62-34-170B																		
<p><b>Application info</b></p> <table border="0"> <tr> <td>Chrysler Sebring (JS) (09/06-12/10)</td> <td>Daewoo Nubira (KLAJ) (04/97--)</td> </tr> <tr> <td>Jeep Compass (MK) (08/06--)</td> <td>Jeep Patriot (MK) (02/07-12/17)</td> </tr> <tr> <td>Mazda 323 (BJ) (05/98-05/04)</td> <td>Mazda MPV I (LV) (09/88-09/99)</td> </tr> <tr> <td>Mazda MPV II (LW) (08/99-12/06)</td> <td>Mazda Premacy (01/99-06/05)</td> </tr> </table>				Chrysler Sebring (JS) (09/06-12/10)	Daewoo Nubira (KLAJ) (04/97--)	Jeep Compass (MK) (08/06--)	Jeep Patriot (MK) (02/07-12/17)	Mazda 323 (BJ) (05/98-05/04)	Mazda MPV I (LV) (09/88-09/99)	Mazda MPV II (LW) (08/99-12/06)	Mazda Premacy (01/99-06/05)								
Chrysler Sebring (JS) (09/06-12/10)	Daewoo Nubira (KLAJ) (04/97--)																		
Jeep Compass (MK) (08/06--)	Jeep Patriot (MK) (02/07-12/17)																		
Mazda 323 (BJ) (05/98-05/04)	Mazda MPV I (LV) (09/88-09/99)																		
Mazda MPV II (LW) (08/99-12/06)	Mazda Premacy (01/99-06/05)																		
Stabilizer link		35-16 060 0037	MSL0849																
<p><b>Notes</b></p> <p>Coupling Rod Front Axle Left with spanner attachment</p> <p>Length [mm] 155 Paired article number 35-16 060 0038   MSL0850 Required quantity 1 Thread Size 1 M10x1,5 Thread Size 2 M10x1,5 replacement in pairs recommended</p>																			
<p><b>References</b></p> <table border="0"> <tr> <td>Mazda GJ6A-34-170A</td> <td>Mazda GK2A-34 170</td> </tr> <tr> <td>Mazda GS1D-34-170</td> <td></td> </tr> </table>				Mazda GJ6A-34-170A	Mazda GK2A-34 170	Mazda GS1D-34-170													
Mazda GJ6A-34-170A	Mazda GK2A-34 170																		
Mazda GS1D-34-170																			

**Application info**

Mazda 6 (GG, GY) (01/02-12/08)

Mazda 6 (GH) (08/07-12/13)

**Stabilizer link****35-16 060 0038****MSL0850****Notes**

Coupling Rod  
Front Axle Right  
with spanner attachment

Length [mm]

155

Paired article number

35-16 060 0037 | MSL0849

Required quantity

1

Thread Size 1

M10x1,5

Thread Size 2

M10x1,5

replacement in pairs recommended

**References**

Mazda GJ6A-34-150A

Mazda GK2A-34 150A

Mazda GS1D-34-150

**Application info**

Mazda 6 (GG, GY) (01/02-12/08)

Mazda 6 (GH) (08/07-12/13)

**Stabilizer link****35-16 060 0044/HD****MSL0911HD****Notes**

Carbon Neutral  
Coupling Rod  
Rear Axle Left  
Rear Axle Right  
with spanner attachment

Length [mm]

75

Required quantity

2

Thread Size 1

M12x1,25

Thread Size 2

M10x1,25

reinforced version

replacement in pairs recommended

**References**

Mazda B37F-28-170

Mazda B37F-28-170A

Mazda B37F-28-170B

**Application info**

Mazda 3 (BL) (12/08-12/14)

**Stabilizer link****35-16 060 0045/HD****MSL1053HD****Notes**Carbon Neutral  
Coupling Rod  
Rear Axle LeftLength [mm] 150  
Paired article number 35-16 060 0046/HD | MSL1054HD  
Required quantity 1  
Thread Size 1 M10 X 1,5  
Thread Size 2 M10 X 1,5  
reinforced version  
replacement in pairs recommended**References**

Mazda KD31-28-190

**Application info**

Mazda 3 (BM) (07/13--)

Mazda 6 (GJ) (08/12--)

Mazda CX-5 I (KE) (11/11-02/17)

Mazda CX-5 II (KF) (11/16--)

**Stabilizer link****35-16 060 0046/HD****MSL1054HD****Notes**Carbon Neutral  
Coupling Rod  
Rear Axle RightLength [mm] 150  
Paired article number 35-16 060 0045/HD | MSL1053HD  
Required quantity 1  
Thread Size 1 M10 X 1,5  
Thread Size 2 M10 X 1,5  
replacement in pairs recommended**References**

Mazda KD31-28-170



**Application info**

Mazda 3 (BM) (07/13--)



Mazda 6 (GJ) (08/12--)

Mazda CX-5 I (KE) (11/11-02/17)

Mazda CX-5 II (KF) (11/16--)

Stabilizer link		35-16 060 0047/HD	MSL1067HD
<b>Notes</b>  Carbon Neutral Coupling Rod Front Axle Left  Length [mm] 284 Paired article number 35-16 060 0048/HD   MSL1068HD Required quantity 1 Thread Size 1 M10 X 1,25 Thread Size 2 M10 X 1,25 reinforced version replacement in pairs recommended			
<b>References</b> Mazda B45A-34-170			
<b>Application info</b> Mazda 3 (BM) (07/13-- )			
Stabilizer link		35-16 060 0048/HD	MSL1068HD
<b>Notes</b>  Carbon Neutral Coupling Rod Front Axle Right  Length [mm] 284 Paired article number 35-16 060 0047/HD   MSL1067HD Required quantity 1 Thread Size 1 M10 X 1,25 Thread Size 2 M10 X 1,25 reinforced version replacement in pairs recommended			
<b>References</b> Mazda B45A-34-150			
<b>Application info</b> Mazda 3 (BM) (07/13-- )			



Stabilizer link		35-16 060 0049/HD	MSL1062HD
<b>Notes</b>  Carbon Neutral Coupling Rod Front Axle Left Front Axle Right  Length [mm] 288 Required quantity 2 Thread Size 1 M10 X 1,25 Thread Size 2 M10 X 1,25 reinforced version replacement in pairs recommended			
<b>References</b> Mazda KD35-34-170			
<b>Application info</b> Mazda 6 (GJ) (08/12--) Mazda CX-5 II (KF) (11/16--) Mazda CX-5 I (KE) (11/11-02/17) Mazda CX-9 (TB) (09/06--) 			
Stabilizer link		35-16 060 0050/HD	MSL1059HD
<b>Notes</b>  Carbon Neutral Coupling Rod Front Axle Left Front Axle Right  Length [mm] 250 Required quantity 2 Thread Size 1 M10 X 1,5 Thread Size 2 M10 X 1,5 replacement in pairs recommended			
<b>References</b> Mazda DA6A-34-170 Mazda DA7V-34-170			
<b>Application info</b> Mazda 2 (DJ) (08/14--) Mazda CX-3 (DK) (01/15--) 			

**Stabilizer link** **35-16 060 0051/HD** **MSL1060HD**

**Notes**

Carbon Neutral  
Coupling Rod  
Front Axle Left  
Front Axle Right

Length [mm] 270  
Required quantity 2  
Thread Size 1 M10 X 1,5  
Thread Size 2 M10 X 1,5  
replacement in pairs recommended



**References**

Mazda BCKE-34-170

**Application info**

Mazda 3 (BP) (11/18--)

Mazda CX-30 (DM) (04/19--)

Mazda MX-30 (DR) (05/20--)

**Stabilizer link** **36-16 060 0001/HD** **MSL0402HD**

**Notes**

Carbon Neutral  
Coupling Rod  
Rear Axle Left  
Rear Axle Right  
with spanner attachment

Length [mm] 90  
Pipe Diameter [mm] 10  
Required quantity 2  
Thread Size 1 M10x1,5  
Thread Size 2 M10x1,5  
reinforced version  
replacement in pairs recommended



**References**

Nissan 56261-47B01



Nissan 56261-4F702

Nissan 56261-4F725

Nissan 56261-6F600

**Application info**

Nissan Micra (K11) (01/92-12/07)

Stabilizer link		36-16 060 0002	MSL0403
<b>Notes</b>  Coupling Rod Rear Axle Right Length [mm] 65 Paired article number 36-16 060 0003   MSL0404 Required quantity 1 Thread Size 1 M12x1,25 Thread Size 2 M12x1,25 replacement in pairs recommended			
<b>References</b> Nissan 56261-EA500			
<b>Application info</b> Nissan Pathfinder (R51) (01/05-- )			
Stabilizer link		36-16 060 0003	MSL0404
<b>Notes</b>  Coupling Rod Rear Axle Left Length [mm] 65 Paired article number 36-16 060 0002   MSL0403 Required quantity 1 Thread Size 1 M12x1,25 Thread Size 2 M12x1,25 replacement in pairs recommended			
<b>References</b> Nissan 56261-EA510			
<b>Application info</b> Nissan Pathfinder (R51) (01/05-- )			

**Stabilizer link****36-16 060 0007****MSL0407****Notes**

Coupling Rod  
Front Axle Left

Length [mm] 65

Paired article number 36-16 060 0008 | MSL0409

Required quantity 1

Thread Size 1 M12x1,25

Thread Size 2 M12x1,25

replacement in pairs recommended

**References**

Nissan 54668-EA010

Nissan 54668-EB30A

**Application info**

Nissan Navara (D40) (10/04--)

Nissan Pathfinder (R51) (01/05--)

**Stabilizer link****36-16 060 0008****MSL0409****Notes**

Coupling Rod  
Front Axle Right

Length [mm] 65

Paired article number 36-16 060 0007 | MSL0407

Required quantity 1

Thread Size 1 M12x1,25

Thread Size 2 M12x1,25

replacement in pairs recommended

**References**



Nissan 54618-EA010

Nissan 54618-EB30A

**Application info**

Nissan Navara (D40) (10/04--)



Nissan Pathfinder (R51) (01/05--)

Stabilizer link		36-16 060 0023	MSL0415
<b>Notes</b>  Coupling Rod Front Axle Left  Length [mm] 65 Paired article number 36-16 060 0025   MSL0416 Required quantity 1 Thread Size 1 M10x1,25 Thread Size 2 M10x1,25 replacement in pairs recommended			
<b>References</b> Nissan 54668-AU000		Nissan 54668-BA30A	
<b>Application info</b> Nissan Primera (P12, WP12) (01/02-- )			
Stabilizer link		36-16 060 0025	MSL0416
<b>Notes</b>  Coupling Rod Front Axle Right  Length [mm] 65 Paired article number 36-16 060 0023   MSL0415 Required quantity 1 Thread Size 1 M10x1,25 Thread Size 2 M10x1,25 replacement in pairs recommended			
<b>References</b> Nissan 54618-AU000		Nissan 54618-BA30A	
<b>Application info</b> Nissan Primera (P12, WP12) (01/02-- )			

Stabilizer link		36-16 060 0026/HD	MSL0417HD
<p><b>Notes</b></p> <p>Carbon Neutral Coupling Rod Rear Axle Left Rear Axle Right with spanner attachment</p> <p>Length [mm] 90 Pipe Diameter [mm] 10 Required quantity 2 Thread Size 1 M10x1,5 Thread Size 2 M12X1,5 reinforced version replacement in pairs recommended</p>		 	

<p><b>References</b></p> <p>Nissan 56261-AV610 Nissan 56261-AV611</p>	
---	--

<p><b>Application info</b></p> <p>Nissan Primera (P12, WP12) (01/02--)</p>	
--	--

Stabilizer link		36-16 060 0030/HD	MSL0421HD
<p><b>Notes</b></p> <p>Carbon Neutral Coupling Rod Front Axle Right with spanner attachment</p> <p>Length [mm] 65 Paired article number 36-16 060 0031/HD   MSL0422HD Required quantity 1 Thread Size 1 M12X1,5 Thread Size 2 M12X1,5 reinforced version replacement in pairs recommended</p>		 	

<p><b>References</b></p> <p>Nissan 54618-8H300</p>	
--	--

<p><b>Application info</b></p> <p>Nissan X-Trail (T30) (01/01-12/13)</p>	
--	--

**Stabilizer link**

36-16 060 0031/HD

MSL0422HD

**Notes**

Carbon Neutral  
Coupling Rod  
Front Axle Left  
with spanner attachment

Length [mm] 65  
Paired article number 36-16 060 0030/HD | MSL0421HD  
Required quantity 1  
Thread Size 1 M12X1,5  
Thread Size 2 M12X1,5  
reinforced version  
replacement in pairs recommended

**References**

Nissan 54668-8H300

**Application info**

Nissan X-Trail (T30) (01/01-12/13)

**Stabilizer link**

36-16 060 0032/HD

MSL0423HD

**Notes**

Carbon Neutral  
Coupling Rod  
Rear Axle Left  
Rear Axle Right  
with spanner attachment

Length [mm] 115  
Required quantity 2  
Thread Size 1 M10x1,5  
Thread Size 2 M10x1,5  
reinforced version  
replacement in pairs recommended

**References**



Nissan 56261-50J00

Nissan 56261-EQ000

**Application info**

Nissan Primera (P10, W10) (06/90-03/98)

Nissan X-Trail (T30) (01/01-12/13)

Stabilizer link		36-16 060 0037/HD	MSL0426HD
<b>Notes</b>  Carbon Neutral Coupling Rod Front Axle Right with spanner attachment  Length [mm] 65 Paired article number 36-16 060 0040/HD   MSL0427HD Required quantity 1 Thread Size 1 M10X1,50 Thread Size 2 M10X1,50 reinforced version replacement in pairs recommended			
<b>References</b> Nissan 54618-4U000 Nissan 54618-BU70A			
<b>Application info</b> Nissan Almera Tino (12/98-02/06)			
Stabilizer link		36-16 060 0040/HD	MSL0427HD
<b>Notes</b>  Carbon Neutral Coupling Rod Front Axle Left with spanner attachment  Length [mm] 65 Paired article number 36-16 060 0037/HD   MSL0426HD Required quantity 1 Thread Size 1 M10x1,50 Thread Size 2 M10X1,50 reinforced version replacement in pairs recommended			
<b>References</b> Nissan 54668-4U000 Nissan 54668-BU70A			
<b>Application info</b> Nissan Almera Tino (12/98-02/06)			



**Stabilizer link** **36-16 060 0046/HD** **MSL0428HD**

**Notes**

Carbon Neutral  
Coupling Rod  
Front Axle Left  
with spanner attachment

Length [mm] 299  
Paired article number 36-16 060 0047/HD | MSL0429HD  
Required quantity 1  
Thread Size 1 M12X1,5  
Thread Size 2 M12X1,5  
reinforced version  
replacement in pairs recommended



**References**

Nissan 54668-1AA0A	Nissan 54668-1AA0E
Nissan 54668-4CB0A	Nissan 54668-JD00A
Renault 546681AA0E	Renault 546684CB0A
Renault 54668JD00A	

**Application info**

Nissan Murano (Z51) (10/07-09/14)	Nissan Qashqai I (J10_) (12/06-04/14)
Nissan Qashqai II (J11_) (11/13--)	Nissan X-Trail (T31) (03/07-12/18)
Nissan X-Trail (T32) (10/13--)	Renault Koleos I (09/08--)
Renault Koleos II (08/16--)	

**Stabilizer link** **36-16 060 0047/HD** **MSL0429HD**

**Notes**

Carbon Neutral  
Coupling Rod  
Front Axle Right  
with spanner attachment

Length [mm] 299  
Paired article number 36-16 060 0046/HD | MSL0428HD  
Required quantity 1  
Thread Size 1 M12X1,5  
Thread Size 2 M12X1,5  
reinforced version  
replacement in pairs recommended



**References**

Nissan 54618-1AA0A  
 Nissan 54618-4CB0A  
 Renault 546181AA0E  
 Renault 54618JD00A

Nissan 54618-1AA0E  
 Nissan 54618-JD00A  
 Renault 546184CB0A

**Application info**

Nissan Murano (Z51) (10/07-09/14)  
 Nissan Qashqai II (J11\_) (11/13--)  
 Nissan X-Trail (T32) (10/13--)  
 Renault Koleos II (08/16--)

Nissan Qashqai I (J10\_) (12/06-04/14)  
 Nissan X-Trail (T31) (03/07-12/18)  
 Renault Koleos I (09/08--)

**Stabilizer link****36-16 060 0052/HD****MSL0573HD****Notes**

Carbon Neutral  
 Coupling Rod  
 Front Axle Left  
 Front Axle Right  
 with spanner attachment

Length [mm]

255

Required quantity

2

Thread Size 1

M10x1,5

Thread Size 2

M10X1,5

reinforced version

replacement in pairs recommended

**References**

Nissan 54618-1FE0A  
 Nissan 54618-ED00A  
 Nissan 54618-JX30A

Nissan 54618-3LH0A  
 Nissan 54618-JX00A

**Application info**

Nissan Almera III (N17) (09/11--)  
 Nissan Micra (K13) (05/10--)  
 Nissan NV200 (02/10--)  
 Nissan Note II (09/12--)

Nissan Cube (Z12) (09/07--)  
 Nissan Micra (K14) (12/16--)  
 Nissan Note I (01/05-08/13)  
 Nissan Tiida (05/04-12/13)

**Stabilizer link****36-16 060 0060****MSL0859****Notes**

Coupling Rod  
 Front Axle Left  
 Front Axle Right  
 with spanner attachment

Length [mm]

250

Required quantity

2

Thread Size 1

M10x1,5

Thread Size 2

M10x1,5

replacement in pairs recommended

**References**

Nissan 54618-9U00A

Nissan 54618-AX600

Nissan 54618-BC40A

Renault 55 11 079 16R

Renault 551100748R

Renault 551107041R

Renault 551108147R

Renault 8200127308

Renault 8200605381

Renault 8201079463

**Application info**

Nissan Micra (K12) (03/02--)

Nissan Note I (01/05-08/13)

Renault Captur I (06/13--)

Renault Clio III / Modus (09/04--)

Renault Clio IV (11/12--)

Renault Zoe (06/12--)

**Stabilizer link****36-16 060 0061/HD****MSL1018HD****Notes**

Carbon Neutral  
 Coupling Rod  
 Front Axle Left

Length [mm]

70

Paired article number

36-16 060 0062/HD | MSL1019HD

Required quantity

1

Thread Size 1

M12X1,5

Thread Size 2

M12X1,5

reinforced version

replacement in pairs recommended

**References**

Nissan 54668-4KH0A

Nissan 54668-5XA0A

Renault 54668-5XA0A

**Application info**

Nissan Navara (D40) (10/04--)

Renault Alaskan (10/16--)

**Stabilizer link**

36-16 060 0062/HD

MSL1019HD

**Notes**

Carbon Neutral  
Coupling Rod  
Front Axle Right

Length [mm] 70  
Paired article number 36-16 060 0061/HD | MSL1018HD  
Required quantity 1  
Thread Size 1 M12X1,5  
Thread Size 2 M12X1,5  
reinforced version  
replacement in pairs recommended

**References**

Nissan 54618-4KH0A  
Renault 54618-5XA0A

Nissan 54618-5XA0A

**Application info**

Nissan Navara (D40) (10/04--)

Renault Alaskan (10/16--)

**Stabilizer link**

36-16 060 0064/HD

MSL1154HD

**Notes**

Carbon Neutral  
Coupling Rod  
Rear Axle Left  
Rear Axle Right

Length [mm] 113  
Required quantity 2  
Thread Size 1 M12X1,5  
replacement in pairs recommended



**References**



Nissan 54618-4FA0A

Nissan 54618-JX05B

**Application info**

Nissan NV200 (02/10--)

Stabilizer link		36-16 060 0066/HD	MSL1203HD
<b>Notes</b>  Coupling Rod Rear Axle Left Length [mm] 113 Paired article number 36-16 060 0067/HD   MSL1204HD Required quantity 1 Thread Size 1 M14x1,5 Thread Size 2 M14x1,5 reinforced version replacement in pairs recommended			
<b>References</b> Nissan 56261-6RR0B			
<b>Application info</b> Nissan Ariya (07/20--) Nissan X-Trail (T33) (09/22--)			
Stabilizer link		36-16 060 0067/HD	MSL1204HD
<b>Notes</b>  Coupling Rod Rear Axle Right Length [mm] 113 Paired article number 36-16 060 0066 Paired article number 36-16 060 0066/HD   MSL1203HD Required quantity 1 Thread Size 1 M14x1,5 Thread Size 2 M14x1,5 reinforced version replacement in pairs recommended			
<b>References</b> Nissan 56261-6RR0A			
<b>Application info</b> Nissan Ariya (07/20--) Nissan X-Trail (T33) (09/22--)			

Stabilizer link		37-16 060 0000/HD	MSL0432HD
<b>Notes</b>			
	Carbon Neutral Coupling Rod with spanner attachment		
Length [mm]	60		
Paired article number	37-16 060 0009/HD   MSL0435HD		
Required quantity	1		
Thread Size 1	M10x1,5		
Thread Size 2	M10x1,5		
reinforced version replacement in pairs recommended			
<b>References</b>			
Hyundai 54830-17020		Hyundai 54830-25020	
Mitsubishi 4056A015		Mitsubishi MR316368	
<b>Application info</b>			
Hyundai Accent II (09/99-11/17)		Hyundai Matrix (06/01-08/10)	
Mitsubishi Lancer VI (09/95-12/03)		Mitsubishi Lancer VII (03/00-12/13)	
Mitsubishi Lancer VIII (03/07--)		Mitsubishi Outlander I (03/01-07/08)	
Stabilizer link		37-16 060 0009/HD	MSL0435HD
<b>Notes</b>			
	Carbon Neutral Coupling Rod with spanner attachment		
Length [mm]	60		
Paired article number	37-16 060 0000/HD   MSL0432HD		
Required quantity	1		
Thread Size 1	M10x1,5		
Thread Size 2	M10x1,5		
reinforced version replacement in pairs recommended			
<b>References</b>			
Hyundai 54830-17010		Hyundai 54830-25010	
<b>Application info</b>			
Hyundai Accent II (09/99-11/17)		Hyundai Matrix (06/01-08/10)	

**Stabilizer link**

37-16 060 0010/HD

MSL0436HD

**Notes**

Carbon Neutral  
Coupling Rod  
Rear Axle Left  
Rear Axle Right  
with spanner attachment

Length [mm] 220  
Required quantity 2  
Thread Size 1 M12X1,5  
Thread Size 2 M12X1,5  
reinforced version  
replacement in pairs recommended

**References**

Hyundai 55530-2E000  
Hyundai 55530-2E200

Hyundai 55530-2E100  
Kia 55530-1F000

**Application info**

Hyundai Tucson I (06/04--)

Kia Sportage II (09/04--)

**Stabilizer link**

37-16 060 0013/HD

MSL0438HD

**Notes**

Carbon Neutral  
Coupling Rod  
Front Axle Left  
with spanner attachment

Length [mm] 264  
Paired article number 37-16 060 0014/HD | MSL0439HD  
Required quantity 1  
Thread Size 1 M12X1,5  
Thread Size 2 M12X1,5  
reinforced version  
replacement in pairs recommended

**References**

Hyundai 54830-26000

Hyundai 54830-26100

**Application info**

Hyundai Santa Fé I (11/00-03/06)

**Stabilizer link****37-16 060 0014/HD****MSL0439HD****Notes**

Carbon Neutral  
Coupling Rod  
Front Axle Right  
with spanner attachment

Length [mm]

264

Paired article number

37-16 060 0013/HD | MSL0438HD

Required quantity

1

Thread Size 1

M12X1,5

Thread Size 2

M12X1,5

reinforced version

replacement in pairs recommended

**References**

Hyundai 54840-26000

Hyundai 54840-26100

**Application info**

Hyundai Santa Fé I (11/00-03/06)

**Stabilizer link****37-16 060 0018/HD****MSL0443HD****Notes**

Carbon Neutral  
Coupling Rod  
Front Axle Left  
Front Axle Right

Length [mm]

54

Required quantity

2

Thread Size 1

M12X1,5

Thread Size 2

M12X1,5

reinforced version

replacement in pairs recommended

**References**

Hyundai 54830-4A000

Hyundai 54830-4A002

Hyundai 54830-4A003

Hyundai 54830-4A850

**Application info**

Hyundai H-1 I (10/97-04/08)

Hyundai Starex (06/97--)



**Stabilizer link****37-16 060 0021/HD****MSL0446HD****Notes**

Carbon Neutral  
Coupling Rod  
Front Axle Right  
with spanner attachment

Length [mm] 198  
Paired article number 37-16 060 0023/HD | MSL0448HD  
Required quantity 1  
Thread Size 1 M10x1,5  
Thread Size 2 M10x1,5  
reinforced version  
replacement in pairs recommended

**References**

Hyundai 54840-1C000

Hyundai 54840-1C100

**Application info**

Hyundai Getz (06/01-01/11)

**Stabilizer link****37-16 060 0022/HD****MSL0447HD****Notes**

Carbon Neutral  
Coupling Rod  
Rear Axle Left  
Rear Axle Right

Length [mm] 130  
Required quantity 2  
Thread Size 1 M10x1,5  
Thread Size 2 M10x1,5  
reinforced version  
replacement in pairs recommended

**References**

Citroën 5170.F5

Citroën 5170.F6

Hyundai 55530-29000

Hyundai 55530-29300

Hyundai 55530-29500

Hyundai 56530-29000

Peugeot 16 08 078 280

Peugeot 5170.F5

Peugeot 5170.F6

**Application info**

Citroën Jumper III (04/06--)  
 Hyundai Coupé II (05/96-04/02)  
 Hyundai Lantra II (06/95-12/00)

Fiat Ducato (250) (07/06--)  
 Hyundai Coupé III (01/01-12/12)  
 Peugeot Boxer III (09/05--)

**Stabilizer link****37-16 060 0023/HD****MSL0448HD****Notes**

Carbon Neutral  
 Coupling Rod  
 Front Axle Left  
 with spanner attachment

Length [mm] 198  
 Paired article number 37-16 060 0021/HD | MSL0446HD  
 Required quantity 1  
 Thread Size 1 M10x1,5  
 Thread Size 2 M10x1,5  
 reinforced version  
 replacement in pairs recommended

**References**

Hyundai 54830-1C000

Hyundai 54830-1C100

**Application info**

Hyundai Getz (06/01-01/11)

**Stabilizer link****37-16 060 0028/HD****MSL0453HD****Notes**

Carbon Neutral  
 Coupling Rod  
 Front Axle Left  
 Front Axle Right  
 with spanner attachment

Length [mm] 237  
 Required quantity 2  
 Thread Size 1 M12X1,5  
 Thread Size 2 M12X1,5  
 reinforced version  
 replacement in pairs recommended

**References**

Hyundai 54830-2E000  
 Kia 54830 1F000

Hyundai 54830-2E100

**Application info**

Hyundai Tucson I (06/04--)

Kia Sportage II (09/04--)

**Stabilizer link****37-16 060 0031/HD****MSL0456HD****Notes**

Carbon Neutral  
Coupling Rod  
Front Axle Right  
with spanner attachment

Length [mm]

341

Paired article number

37-16 060 0032/HD | MSL0457HD

Required quantity

1

Thread Size 1

M12X1,5

Thread Size 2

M12X1,5

reinforced version

replacement in pairs recommended

**References**

Hyundai 54840-2B000

Hyundai 54840-2B200

Kia 54840 2B000

Kia 54840 2B200

**Application info**

Hyundai Santa Fé II (10/05-03/15)

Hyundai ix55 (09/06--)

Kia Sorento II (06/09--)

**Stabilizer link****37-16 060 0032/HD****MSL0457HD****Notes**

Carbon Neutral  
Coupling Rod  
Front Axle Left  
with spanner attachment

Length [mm]

341

Paired article number

37-16 060 0031/HD | MSL0456HD

Required quantity

1

Thread Size 1

M12X1,5

Thread Size 2

M12X1,5

reinforced version

replacement in pairs recommended

**References**

Hyundai 54830-2B000

Hyundai 54830-2B200

Kia 54830 2B000

Kia 54830 2B200

**Application info**

Hyundai Santa Fé II (10/05-03/15)  
Kia Sorento II (06/09--)

Hyundai ix55 (09/06--)

**Stabilizer link****37-16 060 0033/HD****MSL0458HD****Notes**

Carbon Neutral  
Coupling Rod  
Rear Axle Left  
Rear Axle Right

Length [mm] 99  
Required quantity 2  
Thread Size 1 M12X1,5  
Thread Size 2 M12X1,5  
reinforced version  
replacement in pairs recommended

**References**

Hyundai 55530-2B000  
Kia 55530 2B000

Hyundai 55530-2B200  
Kia 55530 2B200

**Application info**

Hyundai Santa Fé II (10/05-03/15)  
Kia Sorento II (06/09--)

Hyundai ix55 (09/06--)

**Stabilizer link****37-16 060 0034/HD****MSL0459HD****Notes**

Carbon Neutral  
Coupling Rod  
Front Axle Right  
with spanner attachment

Length [mm] 286  
Paired article number 37-16 060 0036/HD | MSL0461HD  
Required quantity 1  
Thread Size 1 10x1,5  
Thread Size 2 10x1,5  
reinforced version  
replacement in pairs recommended



**References**

Hyundai 54840-1E000  
 Hyundai 54840-1G000  
 Kia 54840 1E000  
 Kia 54840 1G000

Hyundai 54840-1E100  
 Hyundai 54840-1G500  
 Kia 54840 1E100  
 Kia 54840 1G500

**Application info**

Hyundai Accent III (11/05-12/12)

Kia Rio II (03/05--)

**Stabilizer link****37-16 060 0036/HD****MSL0461HD****Notes**

Carbon Neutral  
 Coupling Rod  
 Front Axle Left  
 with spanner attachment

Length [mm]  
 286

Paired article number  
 37-16 060 0034/HD | MSL0459HD

Required quantity  
 1

Thread Size 1  
 10x1,5

Thread Size 2  
 10x1,5

reinforced version

replacement in pairs recommended

**References**

Hyundai 54830-1E000  
 Hyundai 54830-1G000  
 Kia 54830 1E000  
 Kia 54830 1G000

Hyundai 54830-1E100  
 Hyundai 54830-1G500  
 Kia 54830 1E100  
 Kia 54830 1G500

**Application info**

Hyundai Accent III (11/05-12/12)

Kia Rio II (03/05--)





**Stabilizer link****37-16 060 0041/HD****MSL0464HD****Notes**

Carbon Neutral  
Coupling Rod  
Front Axle Left  
Front Axle Right  
with spanner attachment

Length [mm] 267  
Required quantity 2  
Thread Size 1 M12x1,5  
Thread Size 2 M12X1,5  
reinforced version  
replacement in pairs recommended

**References**

Dodge 4766962AA  
Hyundai 54830-1S000  
Hyundai 54830-2S200  
Hyundai 54830-3U000  
Kia 54830 2S000  
Kia 54830 3U000  
Lancia K04766962AA

Fiat K04766962AA  
Hyundai 54830-2S000  
Hyundai 54830-2S200QQK  
Hyundai 54830-3W300  
Kia 54830 2S200  
Kia 54830 3W300

**Application info**

Dodge Journey (06/08--)  
Hyundai Tucson I (06/04--)  
Kia Sportage III (09/09--)

Fiat Freemont (JC) (08/11--)  
Hyundai ix35 (08/09--)

**Stabilizer link****37-16 060 0042****MSL0465****Notes**

Coupling Rod  
Rear Axle Left  
Rear Axle Right

Length [mm] 140  
Required quantity 2  
Thread Size 1 M12x1,25  
Thread Size 2 M12x1,25  
replacement in pairs recommended





**References**

Hyundai 55530-2S100  
 Hyundai 55530-2Z100  
 Kia 55530 2S100  
 Kia 55530 3U900

Hyundai 55530-2S200  
 Hyundai 55530-3U900  
 Kia 55530 2S200

**Application info**

Hyundai Creta I (01/16--)  
 Hyundai ix35 (08/09--)

Hyundai Tucson I (06/04--)  
 Kia Sportage III (09/09--)

**Stabilizer link****37-16 060 0043****MSL0466****Notes**

Coupling Rod  
 Rear Axle Left  
 Rear Axle Right

Length [mm] 88  
 Required quantity 2  
 Thread Size M12x1,25  
 Thread Size 1 M12x1,25  
 replacement in pairs recommended

**References**

Hyundai 55530-3R000  
 Hyundai 55540-3R000  
 Kia 55530 3R000  
 Kia 55540 3R000

Hyundai 55530-3U800  
 Hyundai 55540-3U800  
 Kia 55530 3U800  
 Kia 55540 3U800

**Application info**

Hyundai Grandeur V (01/11--)  
 Hyundai Tucson I (06/04--)  
 Hyundai ix35 (08/09--)  
 Kia Cee'd III (03/12--)  
 Kia Sportage III (09/09--)

Hyundai Sonata VI (06/09-12/15)  
 Hyundai i30 II (06/11--)  
 Kia Cee'd II (05/12--)  
 Kia Optima (01/10--)

**Stabilizer link****37-16 060 0053****MSL0862****Notes**

Coupling Rod  
Rear Axle Left  
Rear Axle Right  
with spanner attachment

Length [mm]

220

Required quantity

2

Thread Size 1

M12X1,5

Thread Size 2

M12X1,5

replacement in pairs recommended

**References**

Hyundai 55530-2E000

Hyundai 55530-2E100

Hyundai 55530-2E200

Kia 55530-1F000

**Application info**

Hyundai Tucson I (06/04--)

Kia Sportage II (09/04--)

**Suspension Kit****36-14 653 0000/HD****MCR0025HD****Notes**

Carbon Neutral  
Front Axle Left  
Front Axle Right

Replace in pairs only

Required quantity

2

reinforced version

**References**

Nissan 54500-BB00A

Nissan 54500-BR30A

Nissan 54500-JD000

Nissan 54501-BB00A

Nissan 54501-BR30A

Nissan 54501-JD000

Nissan 54501-JG000

Nissan 54501-JG00B

Renault 54501JY00A

Renault 545040445R

Renault 545055212R

**Application info**

Nissan Qashqai I (J10\_) (12/06-04/14)

Nissan X-Trail (T31) (03/07-12/18)

Renault Koleos I (09/08--)

**Suspension Kit** **36-16 610 0001** **MCR0116**

**Notes**

Front Axle Left  
 Front Axle Right  
 for control arm  
 with ball joint  
 with rubber mount

Required quantity  
 replacement in pairs recommended



**References**

- |                    |                    |
|--------------------|--------------------|
| Nissan 40160-9W200 | Nissan 54500-1KA0B |
| Nissan 54500-BB00A | Nissan 54500-BR30A |
| Nissan 54500-JD000 | Nissan 54500-JG000 |
| Nissan 54500-JG00A | Nissan 54500-JG00B |
| Nissan 54501-1KA0B | Nissan 54501-1KA1B |
| Nissan 54501-BB00A | Nissan 54501-BR30A |
| Nissan 54501-JD000 | Nissan 54501-JD00A |
| Nissan 54501-JG000 | Nissan 54501-JG00A |
| Nissan 54501-JG00B | Renault 54500JY00A |
| Renault 54501JY00A | Renault 545040445R |
| Renault 545055212R |                    |

**Application info**

- |                                       |                                    |
|---------------------------------------|------------------------------------|
| Nissan Qashqai I (J10_) (12/06-04/14) | Nissan X-Trail (T31) (03/07-12/18) |
| Renault Koleos I (09/08--)            |                                    |

**Suspension Kit** **36-16 610 0005** **MCR0075**

**Notes**

Front Axle Left  
 Front Axle Right  
 for control arm  
 with ball joint  
 with rubber mount

Required quantity  
 replacement in pairs recommended



**References**

Nissan 54500-AX600

Nissan 54500-BC41A

Nissan 54501-AX600

Nissan 54501-BC41A

Nissan 54560-AX600

Nissan 54500-AX60B

Nissan 54500-BC42A

Nissan 54501-AX60B

Nissan 54501-BC42A

Nissan 54570-AX600

**Application info**

Nissan Micra (K12) (03/02--)

Nissan Note I (01/05-08/13)



**DRIVER'S BEST FRIEND**

**MEYLE**

**Drive train/Transmission**

**Mount, manual transmission**

**714 130 0006**

**MTM0078**

**Notes**

Rubber-Metal Mount  
Torque Support  
Upper  
transmission sided



**References**

Ford 1 070 177

Ford 5 062 530

Ford 98AB-6P082-MA

Ford 9T16-6P082-BA

Ford 1 102 416

Ford 5 208 219

Ford 98AB-6P082-MB

Ford 9T16-6P082-BB

**Application info**

Ford Focus I (08/98-11/09)

Ford Transit '02 (06/02--)

Ford Tourneo '02 (06/02-12/13)

## Steering

**Axial rod** **40-16 031 0000/HD** **MAR0476HD**

**Notes**

Carbon Neutral  
Front Axle Left  
Front Axle Right

Length [mm] 238.5  
Required quantity 2  
Thread Size 1 M12x1  
Thread Size 2 M16x1,5  
reinforced version  
replacement in pairs recommended

**References**

Citroën 3812.E6

Peugeot 3812.E6

**Application info**

Citroën C2 / C3 I / Pluriel (02/02--)

Peugeot 1007 (04/05--)

**Axial rod** **40-16 031 0001/HD** **MAR0524HD**

**Notes**

Carbon Neutral  
Front Axle Left  
Front Axle Right

Length [mm] 230.5  
Required quantity 2  
Thread Size 1 M12x1  
Thread Size 2 M16x1,5  
reinforced version  
replacement in pairs recommended

**References**

Citroën 16 08 652 180

DS 16 086 521 80

Peugeot 16 08 652 180

**Application info**

Citroën C Elyse (11/12--)

Citroën DS3 (11/09-12/16)

DS DS 3 (04/15-07/19)

Peugeot 208 I (03/12--)

Peugeot 301 (11/12--)

## Axial rod

40-16 031 0002/HD

MAR0480HD

## Notes

Carbon Neutral  
Front Axle Left  
Front Axle Right

Length [mm] 221  
Required quantity 2  
Thread Size 1 M14X1,5  
Thread Size 2 M14X1,5  
reinforced version  
replacement in pairs recommended



## References

Citroën 16 108 176 80  
GENERAL MOTORS 93476592  
Peugeot 16 10 817 680

DS 16 108 176 80  
Opel 16 108 176 80

## Application info

Citroën C4 Cactus (09/14--)  
Citroën C4 II / DS4 (02/09--)  
  
Citroën C5 AIRCROSS (11/18--)  
DS DS 9 (09/20--)  
Peugeot 3008 II (05/16--)  
Peugeot 508 II (09/18--)

Citroën C4 Grand Picasso II (01/13--)  
Citroën C4 SPACETOURER / GRAND SPACETOURER  
(04/18--)  
DS DS 7 (09/17--)  
Opel Grandland X (75) (06/17--)  
Peugeot 5008 II (12/16--)

## Axial rod

416 031 0000

MAR0361

## Notes

Front Axle Left  
Front Axle Right

Length [mm] 231  
Required quantity 2  
Thread Size 1 M18x1,5  
Thread Size 2 M14x1,5  
replacement in pairs recommended



## References

Porsche 997 347 322 00

Porsche 997 347 322 01

**Application info**

Porsche 911 (997) (07/04-12/13)

Porsche Cayman (987) (11/05-12/13)

Porsche Boxster (987) (06/04-12/13)

**Axial rod**

416 031 0002/HD

MAR0550HD

**Notes**Carbon Neutral  
Front Axle Left  
Front Axle Right

Length [mm]

192

Required quantity

2

Thread Size 1

16x1,5

Thread Size 2

14x1,5

reinforced version

replacement in pairs recommended

**References**

Porsche 996 347 322 03

**Application info**

Porsche 911 (993) (10/93-12/97)

Porsche Boxster (986) (09/96-12/04)

Porsche 911 (996) (09/97-09/05)

**Axial rod**

416 031 0003

MAR0603

**Notes**Front Axle Left  
Front Axle Right

Length [mm]

189

Required quantity

2

Thread Size 1

M16x1,5

Thread Size 2

M16x1,5

replacement in pairs recommended

**References**

Audi 971 423 810

Porsche 971 423 810

**Application info**

Audi E-TRON (GE\_) (09/18--)

Porsche Taycan (Y1\_) (05/19--)

Porsche Panamera (971) (05/16--)



**Axial rod**

416 031 0004

MAR0628

**Notes**

Front Axle Left  
Front Axle Right

Length [mm] 225  
Required quantity 2  
Thread Size 1 M14x1,5  
Thread Size 2 M14x1,5  
replacement in pairs recommended

**References**

Porsche 991 347 322 00

**Application info**

Porsche 911 (991) (12/11--)  
Porsche Boxster (982) (04/16--)  
Porsche Cayman (982) (04/16--)

Porsche Boxster (981) (04/12--)  
Porsche Cayman (981) (03/13--)

**Axial rod**

416 031 0005

MAR0604

**Notes**

Front Axle Left  
Front Axle Right

Length [mm] 189  
Required quantity 2  
Thread Size 1 M16x1,5  
Thread Size 2 M16x1,5  
replacement in pairs recommended

**References**

Porsche 970 347 133 00

**Application info**

Porsche Panamera (970) (03/09-12/17)

**Axial rod****44-16 031 0000****MAR0281****Notes**Front Axle Left  
Front Axle Right

Length [mm]

293

Required quantity

2

Thread Size 1

M14x1,5

Thread Size 2

M14x1,5

replacement in pairs recommended

**References**

Chrysler 68019643AA

Chrysler 68019643AB

**Application info**

Chrysler Voyager III/Caravan (01/95-12/01)

Chrysler Voyager IV/ Town Country (09/99-12/08)

**Axial rod****44-16 031 0002/HD****MAR0525HD****Notes**Carbon Neutral  
Front Axle Left  
Front Axle Right

Length [mm]

289.5

Required quantity

2

Thread Size 1

M14x1,5

Thread Size 2

M14X1,5

reinforced version

replacement in pairs recommended



**References**

Chrysler 5272500AE

**Application info**

Chrysler Neon II (08/99-12/06)

Chrysler PT Cruiser (06/00-12/10)

Axial rod		45-16 031 0003	MAR0282
<b>Notes</b>			
	Front Axle Left		
	Front Axle Right		
Length [mm]	304		
Required quantity	2		
Thread Size 1	M14x1,5		
Thread Size 2	M14x1,5		
replacement in pairs recommended			
<b>References</b>			
Honda GSV1170		Rover GSV1170	
Rover QBZ10002			
<b>Application info</b>			
Honda Concerto (08/89-10/96)		Rover 200 (XW) (10/89-11/99)	
Rover 200 / 25 (RF) (11/95-06/06)		Rover 400 (XW) (09/93-11/98)	
Rover 400 / 45 (RT) (03/95-05/05)			
Axial rod		516 030 0003	MAR0284
<b>Notes</b>			
	Front Axle Left		
	Front Axle Right		
	for vehicles with power steering		
Length [mm]	178		
Manufacturer Restriction	SMI		
Required quantity	2		
Thread Size 1	M16x1,5		
Thread Size 2	M14x2,0		
replacement in pairs recommended			
<b>References</b>			
Volvo 9191410			
<b>Application info</b>			
Volvo 850 (06/91-10/97)		Volvo C/S/V 70 (12/95-10/05)	
Volvo XC70 I (10/97-10/07)			

## Axial rod

516 030 0004

MAR0285

## Notes

Front Axle Left  
Front Axle Right

Length [mm]

133

Required quantity

2

Thread Size 1

M16x1,5

Thread Size 2

M14x2,0

replacement in pairs recommended



## References

Volvo 272428

## Application info

Volvo S80 I (05/98-02/08)

## Axial rod

516 030 0027

MAR0286

## Notes

Front Axle Left  
Front Axle Right

Length [mm]

304

Required quantity

2

Thread Size 1

M16x1,5

Thread Size 2

M12x1,25

replacement in pairs recommended



## References

Mitsubishi MR244901



Volvo 3345797

## Application info

Mitsubishi Carisma (07/95-06/06)

Volvo S/V 40 (07/95-12/04)

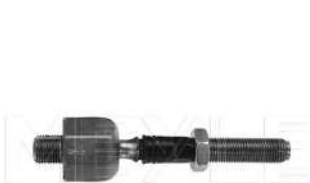

Axial rod		516 031 0002	MAR0296
<b>Notes</b>  Front Axle Left Front Axle Right  Length [mm] 125 Required quantity 2 Thread Size 1 M16x1,5 Thread Size 2 M14x1,5 replacement in pairs recommended			
<b>References</b> Volvo 274353			
<b>Application info</b> Volvo S60 I / V70 II (11/99-04/10)      Volvo S80 I (05/98-02/08) Volvo XC70 I (10/97-10/07)      Volvo XC90 I (06/02-01/15)			
Axial rod		516 031 0003	MAR0297
<b>Notes</b>  Front Axle Left Front Axle Right  Length [mm] 294 Required quantity 2 Thread Size 1 M14x1,5 Thread Size 2 M16x1,5 replacement in pairs recommended			
<b>References</b> Ford 1 251 937      Ford 1 510 270 Ford 3M51-3L519-AA      Ford 3M51-3L519-AB Volvo 274502      Volvo 31201817			
<b>Application info</b> Ford C-Max I (02/07-09/10)      Ford Focus II (10/03--) Ford Kuga I (02/08-11/12)      Volvo C30 (09/06-12/13) Volvo C70 II (03/06-12/13)      Volvo S40 II / V50 (12/03-12/12)			

**Axial rod**

516 031 0004/HD

MAR0526HD

**Notes**

Carbon Neutral  
Front Axle Left  
Front Axle Right

Length [mm] 294  
Required quantity 2  
Thread Size 1 M14x1,5  
Thread Size 2 M16x1,5  
reinforced version  
replacement in pairs recommended



**References**

Ford 1 251 937	Ford 1 510 270
Ford 3M51-3L519-AA	Ford 3M51-3L519-AB
Volvo 274502	Volvo 31201817

**Application info**

Ford C-Max I (02/07-09/10)	Ford Focus II (10/03--)
Ford Kuga I (02/08-11/12)	Volvo C30 (09/06-12/13)
Volvo C70 II (03/06-12/13)	Volvo S40 II / V50 (12/03-12/12)

**Axial rod**

516 031 0005

MAR0542

**Notes**

Front Axle Left  
Front Axle Right

Length [mm] 303  
Required quantity 2  
Thread Size 1 16x1,5  
Thread Size 2 18x1,5  
replacement in pairs recommended



**References**

Volvo 30776255	Volvo 30776425
Volvo 31406474	

**Application info**

Volvo S60 II / V60 (04/10--)	Volvo S80 II (03/06-12/16)
Volvo V70 III (04/07--)	Volvo XC70 II (04/07-12/16)

**Axial rod**

516 031 0006

MAR0298

**Notes**

	Front Axle Left
	Front Axle Right
Length [mm]	125
Required quantity	2
Thread Size 1	M16x1,5
Thread Size 2	M14x1,5
replacement in pairs recommended	

**References**

Volvo 274179

**Application info**

Volvo S60 I / V70 II (11/99-04/10)

Volvo S80 I (05/98-02/08)

Volvo XC70 I (10/97-10/07)

**Axial rod**

516 031 0007

MAR0587

**Notes**

	Front Axle Left
	Front Axle Right
Length [mm]	317
Required quantity	2
Thread Size 1	M16x1,5
Thread Size 2	M18x1,5
replacement in pairs recommended	

**References**

Volvo 31280408



Volvo 31434304



Volvo 31451036

**Application info**

Volvo XC60 I (05/08-12/17)



Axial rod		516 031 0008/HD	MAR0629HD
<b>Notes</b>  Carbon Neutral Front Axle Left Front Axle Right  Length [mm] 330 Required quantity 2 Thread Size 1 M16x1,5 Thread Size 2 M18x1,5 reinforced version replacement in pairs recommended			
<b>References</b> Volvo 31280409		Volvo 31451037	
<b>Application info</b> Volvo XC60 I (05/08-12/17)			
Axial rod		516 031 0009	MAR0581
<b>Notes</b>  Front Axle Left Front Axle Right  Length [mm] 188 Required quantity 2 Thread Size 1 M16x1,5 Thread Size 2 M18x1,5 replacement in pairs recommended			
<b>References</b> Volvo 31429234 Volvo 32268668		Volvo 31658398	
<b>Application info</b> Volvo S60 III (224) (02/19--) Volvo V60 II (02/18--) Volvo XC90 II (09/14--) Volvo S90 II / V90 II (03/16--) Volvo XC60 II (03/17--)			

Axial rod		516 031 0012	MAR0641
<b>Notes</b>			
	Front Axle Left		
	Front Axle Right		
Length [mm]	204		
Required quantity	2		
Thread Size 1	M16x1,5		
Thread Size 2	M14x1,5		
replacement in pairs recommended			
<b>References</b>			
Volvo 32221544		Volvo 32268542	
Volvo 32333943			
<b>Application info</b>			
POLESTAR POLESTAR 2 (02/19--)		Volvo C40 (539) (10/21--)	
Volvo XC40 (536) (10/17--)			
Axial rod		53-16 031 0002	MAR0302
<b>Notes</b>			
	Front Axle Left		
	Front Axle Right		
Length [mm]	230		
Required quantity	2		
Thread Size 1	M18x1,5		
Thread Size 2	M16x1,5		
replacement in pairs recommended			
<b>References</b>			
Land Rover QJB500060		Land Rover TIQ000040	
<b>Application info</b>			
Land Rover Range Rover III (03/02-12/12)			

**Axial rod**

53-16 031 0003

MAR0303

**Notes**

Front Axle Left  
Front Axle Right

Length [mm] 365

Required quantity 2

Thread Size 1 M16x1,5

Thread Size 2 M16x1,5

replacement in pairs recommended

**References**

Land Rover QFK500030

**Application info**

Land Rover Range Rover Sport I (02/05-03/13)

**Axial rod**

53-16 031 0004

MAR0392

**Notes**

Front Axle Left  
Front Axle Right

Length [mm] 298

Required quantity 2

Thread Size 1 M16x1,5

Thread Size 2 M18x1,5

replacement in pairs recommended

**References**

Jaguar J9C7533

Land Rover LR097993

Land Rover LR026271

**Application info**

Jaguar E-Pace (X540) (09/17--)

Land Rover Range Rover Evoque I (06/11-12/19)

Land Rover Discovery Sport (09/14--)

**Axial rod**

53-16 031 0005/HD

MAR0527HD

**Notes**

Carbon Neutral

Length [mm]

375

Paired article number

53-16 031 0006/HD | MAR0528HD

Required quantity

1

Thread Size 1

M20x1,5

Thread Size 2

M16x1,5

reinforced version

replacement in pairs recommended

**References**

Land Rover QFK500020

**Application info**

Land Rover Discovery III (07/04-09/09)

Land Rover Discovery IV (09/09-12/18)

**Axial rod**

53-16 031 0006/HD

MAR0528HD

**Notes**

Carbon Neutral

Length [mm]

375

Paired article number

53-16 031 0005/HD | MAR0527HD

Required quantity

1

Thread Size 1

M16x1,5

Thread Size 2

M16x1,5

reinforced version

replacement in pairs recommended

**References**

Land Rover QFK500010

**Application info**

Land Rover Discovery III (07/04-09/09)

Land Rover Discovery IV (09/09-12/18)

**Axial rod**

53-16 031 0008

MAR0547

**Notes**

Front Axle Left  
Front Axle Right

Length [mm]

329

Required quantity

2

Thread Size 1

M16x1,5

Thread Size 2

M14x1,5

replacement in pairs recommended

**References**

Land Rover LR033529

**Application info**

Land Rover Range Rover IV (08/12--)

Land Rover Range Rover Sport II (04/13--)

**Axial rod**

53-16 031 0009

MAR0554

**Notes**

Front Axle Left  
Front Axle Right

Length [mm]

335

Required quantity

2

Thread Size 1

M16x1,5

Thread Size 2

M16x1,5

replacement in pairs recommended

**References**

Land Rover LR059264

**Application info**

Land Rover Discovery V (09/16--)

Land Rover Range Rover IV (08/12--)

Land Rover Range Rover Sport II (04/13--)

## Axial rod

57-16 031 0000/HD

MAR0617HD

## Notes

Carbon Neutral  
Front Axle Left  
Front Axle Right

Length [mm] 213  
Required quantity 2  
Thread Size 1 M16X1,5  
Thread Size 2 M18x1,5  
reinforced version  
replacement in pairs recommended



## References

Jeep 68105872AA  
Jeep 68105872AC  
Jeep K68105872AB

Jeep 68105872AB  
Jeep K68105872AA  
Jeep K68105872AC

## Application info

Jeep Grand Cherokee IV (WK) (06/10--)

## Axial rod

616 030 5563

MAR0305

## Notes

Front Axle Left  
with left-hand thread

Length [mm] 434  
Paired article number 616 030 5566 | MAR0306  
Required quantity 1  
Thread Size 2 M16x2  
replacement in pairs recommended



## References

GENERAL MOTORS 90304625  
Opel 03 22 079  
Opel 3 22 079  
Saab 42 42 673  
Vauxhall 03 22 147  
Vauxhall 3 22 147

GENERAL MOTORS 90373521  
Opel 03 22 147  
Opel 3 22 147  
Vauxhall 03 22 079  
Vauxhall 3 22 079

**Application info**

Opel Astra F (09/91-01/05)  
 Opel Vectra A (04/88-12/95)  
 Saab 900 II (07/93-04/99)  
 Vauxhall Calibra Mk I (06/90-07/97)

Opel Calibra (08/89-07/97)  
 Saab 9-3 (YS3D) (02/98-08/03)  
 Vauxhall Astra Mk III (01/91-03/01)  
 Vauxhall Cavalier Mk III (08/88-11/95)

**Axial rod****616 030 5566****MAR0306****Notes**

Front Axle Right  
 with right-hand thread  
 Length [mm] 434  
 Paired article number 616 030 5563 | MAR0305  
 Required quantity 1  
 Thread Size 2 M16x2

replacement in pairs recommended

**References**

GENERAL MOTORS 90304626  
 Opel 03 22 146  
 Saab 42 42 681  
 Vauxhall 3 22 146

GENERAL MOTORS 90373522  
 Opel 3 22 146  
 Vauxhall 03 22 146

**Application info**

Opel Astra F (09/91-01/05)  
 Opel Vectra A (04/88-12/95)  
 Saab 900 II (07/93-04/99)  
 Vauxhall Calibra Mk I (06/90-07/97)  
 Vauxhall Cavalier Mk III (08/88-11/95)

Opel Calibra (08/89-07/97)  
 Saab 9-3 (YS3D) (02/98-08/03)  
 Vauxhall Astra Mk III (01/91-03/01)  
 Vauxhall Carlton Mk III (09/86-03/94)

**Axial rod****616 030 5581****MAR0310****Notes**

Front Axle Left  
 Front Axle Right  
 Length [mm] 344  
 Required quantity 2  
 Thread Size 1 M16x1,5  
 Thread Size 2 M14x1,5

replacement in pairs recommended



**References**

GENERAL MOTORS 90498181

Opel 03 24 186

Opel 16 03 206

Saab 48 36 557

Vauxhall 03 24 186

Vauxhall 16 03 206

GENERAL MOTORS 90540319

Opel 16 03 198

Opel 3 24 186

Saab 52-33-424

Vauxhall 16 03 198

Vauxhall 3 24 186

**Application info**

Opel Vectra B (09/95-07/04)

Vauxhall Vectra Mk I (08/95-07/03)

Saab 9-5 (YS3E) (09/97-12/09)

**Axial rod****616 031 0001****MAR0311****Notes**Front Axle Left  
Front Axle Right

Length [mm]

316

Required quantity

2

Thread Size 1

M14x1,5

Thread Size 2

M12x1,5

replacement in pairs recommended

**References**

GENERAL MOTORS 26087867

Opel 16 03 008

Vauxhall 16 03 008

GENERAL MOTORS 93192421

Opel 16 03 845

**Application info**

Opel Corsa C / Combo / Tigra (09/00--)

Vauxhall Corsa Mk II / Tigra / Combo (08/00-02/12)

Vauxhall Combo Mk II (09/01-02/12)

**Axial rod****616 031 0002****MAR0312****Notes**Front Axle Left  
Front Axle Right

Length [mm]

282

Required quantity

2

Thread Size 1

M18x1,5

Thread Size 2

M14x1,5

replacement in pairs recommended





**References**

GENERAL MOTORS 93172256

Opel 16 03 229

Vauxhall 16 03 229

**Application info**

Opel Vectra C / Signum (04/02-01/09)

Vauxhall Vectra Mk II / Signum (01/00-05/09)

**Axial rod****616 031 0003****MAR0313****Notes**

Front Axle Left  
 Front Axle Right  
 for vehicles without electric power steering

Length [mm]

330

Required quantity

2

Thread Size 1

M14x1,5

Thread Size 2

M14x1,5

replacement in pairs recommended

**References**

GENERAL MOTORS 26102922

GENERAL MOTORS 93192415

Opel 16 03 239

Opel 16 03 428

Vauxhall 16 03 239

Vauxhall 16 03 428

**Application info**

Opel Meriva A (05/03-05/10)

Vauxhall Meriva Mk I A (01/03-06/10)

**Axial rod****616 031 0004****MAR0314****Notes**

Front Axle Left  
 Front Axle Right

Length [mm]

284

Required quantity

2

Thread Size 1

M18x1,5

Thread Size 2

M14x1,5

replacement in pairs recommended



**References**

GENERAL MOTORS 93175520  
 GENERAL MOTORS 93191672  
 Opel 16 03 244  
 Opel 16 03 416  
 Saab 93 18 7434  
 Saab 93 19 1672  
 Vauxhall 16 03 244  
 Vauxhall 16 03 416

GENERAL MOTORS 93187434  
 GENERAL MOTORS 95507450  
 Opel 16 03 384  
 Opel 16 09 050  
 Saab 93 18 7485  
 Saab 95 50 7450  
 Vauxhall 16 03 384  
 Vauxhall 16 09 050

**Application info**

Fiat Croma II (06/05--)  
 Saab 9-3 (YS3F) (09/02-02/15)

Opel Vectra C / Signum (04/02-01/09)  
 Vauxhall Vectra Mk II / Signum (01/00-05/09)

**Axial rod****616 031 0005****MAR0315****Notes**

	Front Axle Left
	Front Axle Right
Length [mm]	315
Required quantity	2
Thread Size 1	M14x1,5
Thread Size 2	M12x1,5
replacement in pairs recommended	

**References**



GENERAL MOTORS 26110431  
 Opel 16 03 018  
 Vauxhall 16 03 018

GENERAL MOTORS 93192418  
 Opel 16 03 843

**Application info**

Opel Corsa C / Combo / Tigra (09/00--)  
 Vauxhall Corsa Mk II / Tigra / Combo (08/00-02/12)

Vauxhall Combo Mk II (09/01-02/12)

Axial rod		616 031 0006	MAR0316
<b>Notes</b>  Front Axle Left Front Axle Right  Length [mm] 175 Required quantity 2 Thread Size 1 M14x1,5 Thread Size 2 M16x1,5 replacement in pairs recommended			
<b>References</b> GENERAL MOTORS 9161561 Nissan 48521-00Q0B Opel 44 18 780 Renault 7701470362 Vauxhall 44 18 780		GENERAL MOTORS 93196241 Nissan 48521-00QAF Opel 45 01 261 Renault 7701478762 Vauxhall 45 01 261	
<b>Application info</b> Nissan Interstar I (X70) (04/02--) Opel Movano A (07/98--) Renault Trafic I (03/80-10/02)		Nissan NV400 (11/11--) Renault Master II (03/98--) Vauxhall Movano Mk I (10/98-12/10)	
Axial rod		616 031 0007	MAR0317
<b>Notes</b>  Front Axle Left Front Axle Right  Length [mm] 314 Required quantity 2 Thread Size 1 M14x1,5 Thread Size 2 M14x1,5 replacement in pairs recommended			
<b>References</b> GENERAL MOTORS 900905 Opel 09 00 905 Vauxhall 09 00 905		GENERAL MOTORS 97184819 Opel 9 00 905 Vauxhall 9 00 905	
<b>Application info</b> Opel Frontera B / Monterey B (07/98-07/04)		Vauxhall Frontera Mk II (10/98-10/04)	

## Axial rod

616 031 0008

MAR0318

## Notes

Front Axle Left  
Front Axle Right

Length [mm] 289  
Required quantity 2  
Thread Size 1 M18x1,5  
Thread Size 2 M14x1,5  
replacement in pairs recommended



## References

GENERAL MOTORS 93178160  
GENERAL MOTORS 93191673  
Opel 16 03 290  
Vauxhall 16 03 252  
Vauxhall 16 03 417

GENERAL MOTORS 93187435  
Opel 16 03 252  
Opel 16 03 417  
Vauxhall 16 03 290

## Application info

Opel Vectra C / Signum (04/02-01/09)

Vauxhall Vectra Mk II / Signum (01/00-05/09)

## Axial rod

616 031 0009

MAR0319

## Notes

Front Axle Left  
Front Axle Right

Length [mm] 245  
Required quantity 2  
Thread Size 1 M14x1,5  
Thread Size 2 M12x1,25  
replacement in pairs recommended



## References

GENERAL MOTORS 9204752  
Subaru 48830-86G00  
Suzuki 48830-86G00

Opel 47 01 745  
Suzuki 48830-83E00  
Vauxhall 47 01 745

## Application info

Opel Agila A (09/00-12/07)  
Suzuki Ignis II (MH) (08/03--)  
Vauxhall Agila Mk I (02/00-03/08)

Subaru Justy III (G3X) (09/03--)  
Suzuki Wagon R+ II (MM) (05/00--)

## Axial rod

616 031 0012

MAR0320

## Notes

Front Axle Left  
Front Axle Right

Length [mm] 278  
Manufacturer Restriction ZF  
Required quantity 2  
Thread Size 1 M16x1,5  
Thread Size 2 M14x1,5  
replacement in pairs recommended



## References

GENERAL MOTORS 93181229  
GENERAL MOTORS 93181662  
GENERAL MOTORS 93189669  
Opel 16 03 264  
Opel 16 03 268  
Opel 16 03 358  
Vauxhall 16 03 264  
Vauxhall 16 03 357  
Vauxhall 16 03 359

GENERAL MOTORS 93181230  
GENERAL MOTORS 93189668  
GENERAL MOTORS 93189670  
Opel 16 03 265  
Opel 16 03 357  
Opel 16 03 359  
Vauxhall 16 03 268  
Vauxhall 16 03 358

## Application info

Opel Astra H / Zafira B (01/04-05/19)  
Vauxhall Astra Mk V (01/04--)

Opel Astra J (12/06--)  
Vauxhall Zafira Mk II (04/05-11/14)

## Axial rod

616 031 0013

MAR0321

## Notes

Front Axle Left  
Front Axle Right

Length [mm] 293  
Required quantity 2  
Thread Size 1 M14x1,5  
Thread Size 2 M14x1,5  
replacement in pairs recommended



## References

Fiat 51861102  
GENERAL MOTORS 93189022  
Opel 16 03 543  
Vauxhall 16 03 543

Fiat 52049738  
GENERAL MOTORS 93196540  
Opel 16 09 456  
Vauxhall 16 09 456

**Application info**

ABARTH Grande Punto (12/07-12/12)

Alfa Romeo Mito (08/08--)

Fiat Punto Evo (07/08--)

Vauxhall Combo Mk III (07/06--)

ABARTH Punto III (03/12--)

Fiat Grande Punto (06/05--)

Opel Corsa D (07/06-08/14)

Vauxhall Corsa Mk III (07/06-08/14)

**Axial rod****616 031 0014****MAR0322****Notes**Front Axle Left  
Front Axle Right

Length [mm]

277.5

Required quantity

2

Thread Size 1

M18x1,5

Thread Size 2

M14x1,5

replacement in pairs recommended

**References**

Chevrolet 26059293

Chevrolet 93179557

Chevrolet 93189451

Chevrolet 93191526

Chevrolet 93196778

GENERAL MOTORS 9118128

GENERAL MOTORS 93179557

GENERAL MOTORS 93189450

GENERAL MOTORS 93191521

GENERAL MOTORS 93191529

GENERAL MOTORS 93196778

Opel 16 03 213

Opel 16 03 256

Opel 16 03 302

Opel 16 03 642

Opel 16 09 000

Vauxhall 16 03 003

Vauxhall 16 03 216

Vauxhall 16 03 287

Vauxhall 16 03 643

Vauxhall 16 09 011

Chevrolet 9118128

Chevrolet 93186330

Chevrolet 93191521

Chevrolet 93196777

GENERAL MOTORS 26059293

GENERAL MOTORS 9196409

GENERAL MOTORS 93186330

GENERAL MOTORS 93189451

GENERAL MOTORS 93191526

GENERAL MOTORS 93196777

Opel 16 03 003

Opel 16 03 216

Opel 16 03 287

Opel 16 03 303

Opel 16 03 643

Opel 16 09 011

Vauxhall 16 03 213

Vauxhall 16 03 256

Vauxhall 16 03 642

Vauxhall 16 09 000

**Application info**

Chevrolet Zafira (F75) (02/99-12/12)  
 Opel Astra H / Zafira B (01/04-05/19)  
 Opel Meriva B (06/10-03/17)  
 Vauxhall Astra Mk IV (01/93-08/06)  
 Vauxhall Insignia Mk I A (07/08-05/17)  
 Vauxhall Zafira Mk I (11/98-08/05)

Opel Astra G / Astra Classic / Zafira A (02/98-12/09)  
 Opel Astra J (12/06--)  
 Vauxhall Astra Mk II (09/84-09/93)  
 Vauxhall Astra Mk V (01/04--)  
 Vauxhall Meriva Mk II B (06/10--)  
 Vauxhall Zafira Mk II (04/05-11/14)

**Axial rod****616 031 0015****MAR0323****Notes**

Front Axle Left  
 Front Axle Right  
 for vehicles with electric power steering

Length [mm] 317  
 Required quantity 2  
 Thread Size 1 M14x1,5  
 Thread Size 2 M14x1,5  
 replacement in pairs recommended

**References**

GENERAL MOTORS 26110429  
 Opel 16 03 016  
 Vauxhall 16 03 016

GENERAL MOTORS 93192416  
 Opel 16 03 429  
 Vauxhall 16 03 429

**Application info**

Opel Meriva A (05/03-05/10)

Vauxhall Meriva Mk I A (01/03-06/10)

**Axial rod****616 031 0016****MAR0324****Notes**

Front Axle Left  
 Front Axle Right

Length [mm] 361  
 Required quantity 2  
 Thread Size 1 M16x1,5  
 Thread Size 2 M14x1,5  
 replacement in pairs recommended



**References**

Chevrolet 95954754

GENERAL MOTORS 94567347

GENERAL MOTORS 96626525

Opel 48 08 603

Vauxhall 48 08 602

Vauxhall 48 17 547

Chevrolet 96626521

GENERAL MOTORS 96626521

Opel 48 08 602

Opel 48 17 547

Vauxhall 48 08 603

**Application info**

Chevrolet Captiva I (06/06--)

Vauxhall Antara (08/06--)

Opel Antara (05/06--)

**Axial rod****616 031 0017****MAR0325****Notes**

Front Axle Left

Front Axle Right

Length [mm]

308

Required quantity

2

Thread Size 1

M18x1,5

Thread Size 2

M16x1,5

replacement in pairs recommended

**References**

Buick 13271996

Opel 66 06 030

GENERAL MOTORS 13271996

Vauxhall 66 06 030

**Application info**

Opel Insignia A (07/08-03/17)

Vauxhall Insignia Mk I A (07/08-05/17)

**Axial rod****616 031 0018****MAR0326****Notes**

Front Axle Left

Front Axle Right

Length [mm]

305

Required quantity

2

Thread Size 1

M18x1,5

Thread Size 2

M12x1,25

replacement in pairs recommended





**References**

GENERAL MOTORS 93194002  
Suzuki 48830-62J00  
Suzuki 48830-63J00-000

Opel 47 09 161  
Suzuki 48830-63J00  
Vauxhall 47 09 161

**Application info**

Opel Agila B (04/08-10/14)  
Suzuki Swift III (02/05--)

Suzuki Splash (01/08--)  
Vauxhall Agila Mk II (01/08-11/14)

**Axial rod****616 031 0019****MAR0327****Notes**

Front Axle Left  
Front Axle Right  
for vehicles with electric power steering

Length [mm] 290  
Required quantity 2  
Thread Size 1 M16x1,5  
Thread Size 2 M16x1,5  
replacement in pairs recommended

**References**

Chevrolet 13286687  
GENERAL MOTORS 13314465  
Opel 16 09 029  
Vauxhall 16 09 029

GENERAL MOTORS 13286687  
Opel 16 09 027  
Vauxhall 16 09 027

**Application info**

Chevrolet Cruze (J300, J305) (07/00--)  
Chevrolet Volt (04/11--)  
Opel Astra J (12/06--)  
Vauxhall Astra Mk V (01/04--)

Chevrolet Cruze (J308) (08/12--)  
Opel Ampera (11/11-03/15)  
Vauxhall Ampera (03/12--)  
Vauxhall Astra Mk VI (12/09-10/15)

**Axial rod****616 031 0022****MAR0330****Notes**

Front Axle Left  
Front Axle Right

Length [mm] 315  
Required quantity 2  
Thread Size 1 M16x1,5  
Thread Size 2 M16x1,5  
replacement in pairs recommended



**References**

GENERAL MOTORS 13332651  
 Opel 16 09 181  
 Vauxhall 13332651

GENERAL MOTORS 13332653  
 Opel 16 09 183  
 Vauxhall 13332653

**Application info**

Opel Insignia A (07/08-03/17)

Vauxhall Insignia Mk I A (07/08-05/17)

**Axial rod****616 031 0023****MAR0331****Notes**

Front Axle Left  
 Front Axle Right  
 for vehicles with electric power steering

Length [mm] 226  
 Required quantity 2  
 Thread Size 1 M16x1,5  
 Thread Size 2 M16x1,5  
 replacement in pairs recommended

**References**

GENERAL MOTORS 13354542  
 Vauxhall 16 09 187

Opel 16 09 187

**Application info**

Opel Astra J (12/06--)  
 Vauxhall Astra Mk VI (12/09-10/15)

Opel Cascada (03/13-04/19)  
 Vauxhall Cascada (02/13--)

**Axial rod****616 031 0024****MAR0332****Notes**

Front Axle Left  
 Front Axle Right

Length [mm] 335  
 Required quantity 2  
 Thread Size 1 M14x1,5  
 Thread Size 2 M14x1,5  
 replacement in pairs recommended

**References**

Chevrolet 95952929  
 GENERAL MOTORS 95952929  
 Opel 16 09 213

GENERAL MOTORS 95915221  
 Opel 16 09 202  
 Vauxhall 16 09 213

**Application info**

Chevrolet Aveo II (03/11--)  
Opel Mokka A (06/12--)

Chevrolet Trax (12/12--)  
Vauxhall Mokka A (06/12--)

**Axial rod****616 031 0028****MAR0393****Notes**

Front Axle Left  
Front Axle Right

Length [mm] 309  
Required quantity 2  
Thread Size 1 M16X1,5  
Thread Size 2 M16X1,5  
replacement in pairs recommended

**References**

Chevrolet 13286688  
GENERAL MOTORS 13286688  
Opel 16 09 184  
Vauxhall 16 09 184

Chevrolet 13398595  
Opel 13286688  
Vauxhall 13 28 6688

**Application info**

Chevrolet Orlando (J309) (12/10--)  
Vauxhall Zafira Mk III (10/11-08/18)

Opel Zafira C (Tourer) (10/11--)

**Axial rod****616 031 0030/HD****MAR0529HD****Notes**

Carbon Neutral  
Front Axle Left  
Front Axle Right

Length [mm] 245  
Required quantity 2  
Thread Size 1 M14x1,5  
Thread Size 2 M12x1,25  
reinforced version  
replacement in pairs recommended

**References**

GENERAL MOTORS 9204752  
Subaru 48830-86G00  
Suzuki 48830-86G00

Opel 47 01 745  
Suzuki 48830-83E00  
Vauxhall 47 01 745

**Application info**

Opel Agila A (09/00-12/07)  
 Suzuki Ignis II (MH) (08/03--)  
 Vauxhall Agila Mk I (02/00-03/08)

Subaru Justy III (G3X) (09/03--)  
 Suzuki Wagon R+ II (MM) (05/00--)

**Axial rod****616 031 0031/HD****MAR0530HD****Notes**

Carbon Neutral  
 Front Axle Left  
 Front Axle Right

Length [mm] 293

Required quantity 2

Thread Size 1 M14x1,5

Thread Size 2 M14x1,5

reinforced version

replacement in pairs recommended

**References**

GENERAL MOTORS 93189022

Opel 16 03 543

Vauxhall 16 03 543

GENERAL MOTORS 93196540

Opel 16 09 456

Vauxhall 16 09 456

**Application info**

ABARTH Grande Punto (12/07-12/12)

Alfa Romeo Mito (08/08--)

Fiat Punto Evo (07/08--)

Vauxhall Combo Mk III (07/06--)

ABARTH Punto III (03/12--)

Fiat Grande Punto (06/05--)

Opel Corsa D (07/06-08/14)

Vauxhall Corsa Mk III (07/06-08/14)

**Axial rod****616 031 0032/HD****MAR0531HD****Notes**

Carbon Neutral  
 Front Axle Left  
 Front Axle Right  
 for vehicles with hydraulic power steering

Length [mm] 350

Required quantity 2

Thread Size 1 M16x1,5

Thread Size 2 M14x1,5

reinforced version

replacement in pairs recommended



**References**

Chevrolet 95932789  
Opel 16 09 205

GENERAL MOTORS 95932789  
Vauxhall 16 09 205

**Application info**

Chevrolet Trax (12/12--)  
Vauxhall Mokka A (06/12--)

Opel Mokka A (06/12--)

**Axial rod****616 031 0033/HD****MAR0532HD****Notes**

Carbon Neutral  
Front Axle Left  
Front Axle Right

Length [mm] 290  
Required quantity 2  
Thread Size 1 M14x1,5  
Thread Size 2 M14X1,5  
reinforced version  
replacement in pairs recommended

**References**

GENERAL MOTORS 39075199  
Opel 16 09 211

GENERAL MOTORS 95514914  
Vauxhall 16 09 211

**Application info**

Opel Adam (10/12-02/19)  
Vauxhall Adam (10/12-04/19)

Opel Corsa E (09/14--)  
Vauxhall Corsa Mk IV (08/14--)

**Axial rod****616 031 0034/HD****MAR0533HD****Notes**

Carbon Neutral  
Front Axle Left  
Front Axle Right

Length [mm] 284  
Required quantity 2  
Thread Size 1 M18x1,5  
Thread Size 2 M14x1,5  
reinforced version  
replacement in pairs recommended



**References**

GENERAL MOTORS 93175520  
 GENERAL MOTORS 93191672  
 Opel 16 03 244  
 Opel 16 03 416  
 Saab 93 18 7434  
 Saab 93 19 1672  
 Vauxhall 16 03 244  
 Vauxhall 16 03 416

GENERAL MOTORS 93187434  
 GENERAL MOTORS 95507450  
 Opel 16 03 384  
 Opel 16 09 050  
 Saab 93 18 7485  
 Saab 95 50 7450  
 Vauxhall 16 03 384  
 Vauxhall 16 09 050

**Application info**

Fiat Croma II (06/05--)  
 Saab 9-3 (YS3F) (09/02-02/15)

Opel Vectra C / Signum (04/02-01/09)  
 Vauxhall Vectra Mk II / Signum (01/00-05/09)

**Axial rod****616 031 0035/HD****MAR0534HD****Notes**

Carbon Neutral  
 Front Axle Left  
 Front Axle Right  
 Length [mm] 289  
 Required quantity 2  
 Thread Size 1 M18x1,5  
 Thread Size 2 M14x1,5

reinforced version  
 replacement in pairs recommended

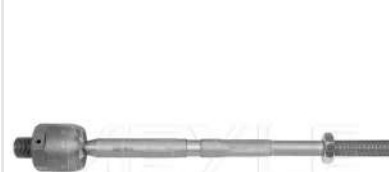
**References**



GENERAL MOTORS 93178160  
 GENERAL MOTORS 93191673  
 Opel 16 03 290  
 Vauxhall 16 03 252  
 Vauxhall 16 03 417

GENERAL MOTORS 93187435  
 Opel 16 03 252  
 Opel 16 03 417  
 Vauxhall 16 03 290

**Application info**

Opel Vectra C / Signum (04/02-01/09)

Vauxhall Vectra Mk II / Signum (01/00-05/09)

Axial rod		616 031 0036/HD	MAR0535HD
<b>Notes</b>  Carbon Neutral Front Axle Left Front Axle Right  Length [mm] 308 Required quantity 2 Thread Size 1 M18x1,5 Thread Size 2 M16x1,5 reinforced version replacement in pairs recommended			
<b>References</b> Buick 13271996 Opel 66 06 030		GENERAL MOTORS 13271996 Vauxhall 66 06 030	
<b>Application info</b> Opel Insignia A (07/08-03/17)		Vauxhall Insignia Mk I A (07/08-05/17)	
Axial rod		616 031 0037/HD	MAR0536HD
<b>Notes</b>  Carbon Neutral Front Axle Left Front Axle Right for vehicles with electro-hydraulic steering  Length [mm] 290 Required quantity 2 Thread Size 1 M16x1,5 Thread Size 2 M16x1,5 reinforced version replacement in pairs recommended			
<b>References</b> Chevrolet 13278358 GENERAL MOTORS 13314168 GENERAL MOTORS 920007 Opel 09 20 007 Opel 9 20 007 Vauxhall 9 20 007		GENERAL MOTORS 13278358 GENERAL MOTORS 920005 Opel 09 20 005 Opel 9 20 005 Vauxhall 9 20 005	
<b>Application info</b> Chevrolet Cruze (J300, J305) (07/00--) Opel Astra J (12/06--) Chevrolet Cruze (J308) (08/12--) Vauxhall Astra Mk VI (12/09-10/15)			

**Axial rod****616 031 0038/HD****MAR0556HD****Notes**

Carbon Neutral  
 Front Axle Left  
 Front Axle Right

Length [mm]

242

Required quantity

2

Thread Size 1

M14x1,5

Thread Size 2

M14X1,5

reinforced version

replacement in pairs recommended

**References**

GENERAL MOTORS 13464344

Opel 13464344

Vauxhall 13 46 4344

**Application info**

Opel Astra K (06/15--)

Vauxhall Astra Mk VII (07/15--)

**Axial rod****616 031 0039/HD****MAR0618HD****Notes**

Carbon Neutral  
 Front Axle Left  
 Front Axle Right

Length [mm]

242

Required quantity

2

Thread Size 1

M16X1,5

Thread Size 2

M14x1,5

reinforced version

replacement in pairs recommended

**References**

GENERAL MOTORS 95371542

Opel 16 09 224





Vauxhall 16 09 224

**Application info**

Opel Karl (01/15-03/19)

Vauxhall Viva (01/15-03/19)



Axial rod		616 031 0041	MAR0588
<b>Notes</b>  Front Axle Left Front Axle Right  Length [mm] 281 Required quantity 2 Thread Size 1 M14x1,5 Thread Size 2 M14x1,5 replacement in pairs recommended		  	
<b>References</b> Citroën 16 310 567 80 Opel 16 310 567 80 Vauxhall 35 56 147		GENERAL MOTORS 3556147 Opel 35 56 147	
<b>Application info</b> Citroën C3 AIRCROSS II (06/17--) Vauxhall Crossland X (03/17--)		Opel Crossland X (03/17--)	
Axial rod		616 031 0044/HD	MAR0614HD
<b>Notes</b>  Carbon Neutral Front Axle Left Front Axle Right  Length [mm] 242 Required quantity 2 Thread Size 1 M18x1,5 Thread Size 2 M16x1,5 reinforced version replacement in pairs recommended		  	
<b>References</b> GENERAL MOTORS 22776531 Vauxhall 16 09 219		Opel 16 09 219	
<b>Application info</b> Opel Insignia A (07/08-03/17)		Vauxhall Insignia Mk I A (07/08-05/17)	

## Axial rod

70-16 031 0000

MAR0654

## Notes

	Front Axle Left
	Front Axle Right
Length [mm]	242
Required quantity	2
Thread Size 1	M16x1,5
Thread Size 2	M14x1,5
replacement in pairs recommended	



## References

TESLA 1044831-00-F	TESLA 1044831-00-H
TESLA 1044831-99-E	TESLA 1044841-00-E

## Application info

TESLA Model 3 (01/17--)	TESLA Model Y (03/19--)
-------------------------	-------------------------

## Axial rod

716 031 0000

MAR0343

## Notes

Length [mm]	380
Paired article number	716 031 0001   MAR0344
Required quantity	1
Thread Size 1	M16x1,5
Thread Size 2	M16x1,5
replacement in pairs recommended	



## References

Ford 1 370 709	Ford 4 059 923
Ford 4 602 028	Ford 6C11-3L519-AA
Ford YC15-3L519-AA	Ford YC15-3L519-AB

## Application info

Ford Transit '00 (01/00-05/06)	Ford Transit '06 (04/06-12/14)
--------------------------------	--------------------------------

**Axial rod**

716 031 0001

MAR0344

**Notes**

Length [mm]	382
Paired article number	716 031 0000   MAR0343
Required quantity	1
Thread Size 1	M20x1,5
Thread Size 2	M16x1,5
replacement in pairs recommended	

**References**

Ford 1 370 710	Ford 4 059 924
Ford 4 577 976	Ford 6C11-3L519-BA
Ford YC15-3L519-BA	Ford YC15-3L519-BB

**Application info**

Ford Transit '00 (01/00-05/06)	Ford Transit '06 (04/06-12/14)
--------------------------------	--------------------------------

**Axial rod**

716 031 0002

MAR0358

**Notes**

	Front Axle Left
	Front Axle Right
Length [mm]	289
Required quantity	2
Thread Size 1	M14x1,5
Thread Size 2	M16x1,5
replacement in pairs recommended	

**References**

Ford 1 714 484	Ford 1 780 104
Ford 2 253 495	Ford AV6C-3L519-AA
Ford AV6C-3L519-BA	Ford KV6C-3280-AB
Volvo 31317779	

**Application info**

Ford C-Max II (04/10--)	Ford Focus III (07/10--)
Ford Kuga II (05/12--)	Ford Tourneo '13 (09/13--)
Ford Transit '13 (02/13--)	Volvo V40 II (03/12--)

**Axial rod**

716 031 0003

MAR0345

**Notes**

Front Axle Left  
Front Axle Right

Length [mm] 300  
Required quantity 2  
Thread Size 1 M14x1,5  
Thread Size 2 1/2"-20 UNF  
replacement in pairs recommended

**References**

Ford 4 048 739 Ford 6 639 188  
Ford 6 790 700 Ford 91FB-3L519-AA  
Ford 92FB-3L519-AA Ford XS5C-3L519-AA

**Application info**

Ford Fiesta II (03/83-12/95) Ford Fiesta III (01/89-01/97)  
Ford KA I (09/96-11/08)

**Axial rod**

716 031 0005

MAR0347

**Notes**

Front Axle Left  
Front Axle Right

Length [mm] 339  
Required quantity 2  
Thread Size 1 M14x1,5  
Thread Size 2 M14x2  
replacement in pairs recommended

**References**

Ford 1 085 520 Ford 3 707 333  
Ford 3 707 533 Ford 98AG-3L519-AA  
Ford XS4C-3280-BA

**Application info**

Ford Focus I (08/98-11/09) Ford Tourneo '02 (06/02-12/13)  
Ford Transit '02 (06/02--)



**Axial rod**

716 031 0009

MAR0350

**Notes**

Front Axle Left  
Front Axle Right

Length [mm] 345  
Required quantity 2  
Thread Size 1 M14x1,5  
Thread Size 2 M16x1,5  
replacement in pairs recommended

**References**

Ford 1S7C-3280-BA

Ford 1S7C-3280-BB

Ford 4 097 484

Ford 4 111 327

Ford (Chanagan) 1S7C-3280-BB

**Application info**

Ford Mondeo III (10/00-09/07)

**Axial rod**

716 031 0010

MAR0351

**Notes**

Front Axle Left  
Front Axle Right

Length [mm] 315  
Required quantity 2  
Thread Size 1 M16x1,5  
Thread Size 2 M18x1,5  
replacement in pairs recommended

**References**

Ford 1 433 271

Ford 1 596 574

Ford 6G91-3280-AA

Ford 6G91-3280-AB

Land Rover LR016869

Volvo 30776250

Volvo 31280658

Volvo 31451035

Volvo (Changan) 31280658

**Application info**

Ford Galaxy II (05/06-06/15)

Ford Mondeo IV (03/07-01/15)

Ford S-Max I (05/06-12/14)



Land Rover Freelander II (10/06-12/15)

Volvo S60 II / V60 (04/10--)

Volvo S80 II (03/06-12/16)

Volvo V70 III (04/07--)

Volvo XC70 II (04/07-12/16)

Axial rod		716 031 0013	MAR0352
<b>Notes</b>  Front Axle Left Front Axle Right  Length [mm] 289 Required quantity 2 Thread Size 1 M14x1,5 Thread Size 2 M14x1,5 replacement in pairs recommended			
<b>References</b> Ford 1 545 457                      Ford 1 894 111 Ford 8V51-3L519-AA              Ford E4B1-3280-AA Mazda D651-32-240			
<b>Application info</b> Ford B-MAX (08/12--) Ford KA III (08/14--) Ford Transit Courier '14 (02/14--) Ford Fiesta VI (06/08--) Ford Tourneo '14 (02/14--) Mazda 2 (DE) (07/07-06/15)			
Axial rod		716 031 0014	MAR0353
<b>Notes</b>  Front Axle Left Front Axle Right for vehicles with hydraulic power steering  Length [mm] 300 Required quantity 2 Thread Size 1 M14x1,5 Thread Size 2 M16x1,5 replacement in pairs recommended			
<b>References</b> Ford 1 754 076                      Ford 1 836 649 Ford 1 899 978                      Ford BV61-3L519-AA Ford BV61-3L519-AB              Ford BV61-3L519-AC			
<b>Application info</b> Ford Focus III (07/10--) 			

## Axial rod

716 031 0016/HD

MAR0537HD

## Notes

Carbon Neutral  
Front Axle Left  
Front Axle Right

Length [mm]

289

Required quantity

2

Thread Size 1

M14x1,5

Thread Size 2

M14x1,5

reinforced version

replacement in pairs recommended



## References

Ford 1 545 457

Ford 1 894 111

Ford 8V51-3L519-AA

Ford E4B1-3280-AA

Mazda D651-32-240

## Application info

Ford B-MAX (08/12--)

Ford Fiesta VI (06/08--)

Ford KA III (08/14--)

Ford Tourneo '14 (02/14--)

Ford Transit Courier '14 (02/14--)

Mazda 2 (DE) (07/07-06/15)

## Axial rod

716 031 0017/HD

MAR0538HD

## Notes

Carbon Neutral  
Front Axle Left  
Front Axle Right

Length [mm]

289

Required quantity

2

Thread Size 1

M14x1,5

Thread Size 2

M16x1,5

reinforced version

replacement in pairs recommended



## References

Ford 1 714 484

Ford 1 780 104

Ford 2 253 495

Ford AV6C-3L519-AA

Ford AV6C-3L519-BA

Ford KV6C-3280-AB

Volvo 31317779



**Application info**

Ford C-Max II (04/10--)  
 Ford Kuga II (05/12--)  
 Ford Transit '13 (02/13--)

Ford Focus III (07/10--)  
 Ford Tourneo '13 (09/13--)  
 Volvo V40 II (03/12--)

**Axial rod****716 031 0018/HD****MAR0539HD****Notes**

Carbon Neutral  
 Front Axle Left  
 Front Axle Right

Length [mm] 292  
 Required quantity 2  
 Thread Size 1 M14x1,5  
 Thread Size 2 M16x1,5  
 reinforced version  
 replacement in pairs recommended

**References**

Ford 1 317 453  
 Ford 4M51-3L519-AA

Ford 1 377 655  
 Ford 4M51-3L519-AB

**Application info**

Ford Focus II (10/03--)

**Axial rod****716 031 0019/HD****MAR0540HD****Notes**

Carbon Neutral  
 Front Axle Left  
 Front Axle Right  
 for vehicles with hydraulic power steering

Length [mm] 300  
 Required quantity 2  
 Thread Size 1 M14x1,5  
 Thread Size 2 M16x1,5  
 reinforced version  
 replacement in pairs recommended

**References**

Ford 1 754 076  
 Ford 1 899 978  
 Ford BV61-3L519-AB

Ford 1 836 649  
 Ford BV61-3L519-AA  
 Ford BV61-3L519-AC

**Application info**

Ford Focus III (07/10--)

**Axial rod**

716 031 0020/HD

MAR0541HD

**Notes**

Carbon Neutral  
Front Axle Left  
Front Axle Right

Length [mm] 382  
Required quantity 2  
Thread Size 1 M16x1,5  
Thread Size 2 M16X1,5  
reinforced version  
replacement in pairs recommended

**References**

Ford 1 763 991

Ford BK21-3L519-AA

**Application info**

Ford Tourneo '12 (04/12--)

Ford Transit '14 (08/13--)

Ford Transit Custom '12 (04/12--)

**Axial rod**

716 031 0021

MAR0580

**Notes**

Front Axle Left  
Front Axle Right

Length [mm] 275  
Required quantity 2  
Thread Size 1 M14x1,5  
Thread Size 2 M14x1,5  
replacement in pairs recommended





**References**

Ford 2 090 582

Ford KTH1BC-3L519-AA

**Application info**

Ford Fiesta VII (05/17--)

Axial rod		716 031 0022	MAR0592
<b>Notes</b>  Front Axle Left Front Axle Right  Length [mm] 300 Required quantity 2 Thread Size 1 M16X1,5 Thread Size 2 M18x1,5 replacement in pairs recommended		 	
<b>References</b> Ford 1 824 228 Ford DG9C-3D032-BA		Ford D38KADG9C3280RW Volvo 31360303	
<b>Application info</b> Ford Galaxy III (01/15--) Ford S-Max II (01/15--)		Ford Mondeo V (09/12--) Volvo S60 II / V60 (04/10--)	
Axial rod		716 031 0027/HD	MAR0611HD
<b>Notes</b>  Carbon Neutral Front Axle Left Front Axle Right  Length [mm] 303 Required quantity 2 Thread Size 1 14x1,5 Thread Size 2 14x1,5 reinforced version replacement in pairs recommended		 	
<b>References</b> Ford 1 831 526		Ford C1BC-3L519-AA	
<b>Application info</b> Ford Fiesta VI (06/08--)			

**Axial rod**

716 031 0028/HD

MAR0569HD

**Notes**

Carbon Neutral  
 Front Axle Left  
 Front Axle Right

Length [mm]

308

Required quantity

2

Thread Size 1

M14x1,5

Thread Size 2

M14X1,5

reinforced version

replacement in pairs recommended

**References**

Ford 1 785 002

Ford 1 933 357

Ford CN15-3280-AA

Ford CN15-3280-BA

**Application info**

Ford Ecosport (09/11--)

**Axial rod**

716 031 0029/HD

MAR0570HD

**Notes**

Carbon Neutral  
 Front Axle Left  
 Front Axle Right

Length [mm]

279

Required quantity

2

Thread Size 1

M14x1,5

Thread Size 2

M14X1,5

reinforced version

replacement in pairs recommended

**References**

Ford 2 180 383

Ford GN15-3280-AA

**Application info**

Ford Ecosport (09/11--)

<b>Axial rod</b>	<b>716 031 0030</b>	<b>MAR0605</b>
------------------	---------------------	----------------

<b>Notes</b>	Front Axle Left		
	Front Axle Right		
	Length [mm]		284
	Required quantity		2
	Thread Size 1		M16X1,5
	Thread Size 2		M16X1,5
	replacement in pairs recommended		

<b>References</b>	Ford 2 194 056	Ford 2 475 900
	Ford JX6C-3D032-AA	Ford JX6C-3L519-AA

<b>Application info</b>	Ford Focus IV (01/18--)
-------------------------	-------------------------

<b>Axial rod</b>	<b>816 031 0001</b>	<b>MAR0474</b>
------------------	---------------------	----------------

<b>Notes</b>	Front Axle Left		
	Front Axle Right		
	Length [mm]		286
	Required quantity		2
	Thread Size 1		M16x1,5
	Thread Size 2		M14x1,5
	replacement in pairs recommended		

<b>References</b>	Saab 52-35-585	Saab 52-39-330
	Saab 93194335	

<b>Application info</b>	Saab 9-5 (YS3E) (09/97-12/09)	Saab 9-5 (YS3G) (01/10-01/12)
-------------------------	-------------------------------	-------------------------------

**Axial rod****816 031 0004****MAR0464****Notes**Front Axle Left  
Front Axle Right

Length [mm]

295

Required quantity

2

Thread Size 1

M14x1,5

Thread Size 2

M14X1,5

replacement in pairs recommended

**References**

Saab 12 787 823

Saab 12 804 238

**Application info**

Saab 9-3 (YS3F) (09/02-02/15)

**Tie rod assembly****716 030 0003/HD****MTA0302HD****Notes**

Front Axle Left

Paired article number

Required quantity

1

Thread Size 1

M12x1,75

Thread Size 2

M14x1,5

reinforced version

replacement in pairs recommended

**References**

Ford 1 545 339

Ford 1 545 456

Ford 1 545 457

Ford 1 871 102

Ford 1 894 111

Ford 2 248 199

Ford 8V51-3C437-AA

Ford 8V51-3L519-AA

Ford 8V51-3L575-AA

Ford 8V51-3L575-AB

Ford E4B1-3280-AA

Ford J7BC-3C437-AA

**Application info**

Ford B-MAX (08/12--)

Ford Fiesta VI (06/08--)

Ford Tourneo '14 (02/14--)

Ford Transit Courier '14 (02/14--)

## Tie rod end

40-16 020 0000/HD

MTE0769HD

## Notes

Carbon Neutral  
 Front Axle Right  
 Length [mm] 215  
 Paired article number 40-16 020 0001/HD | MTE0770HD  
 Required quantity 1  
 Thread Size 1 M12x1,5  
 Thread Size 2 M14x1,5

reinforced version  
 replacement in pairs recommended



## References

Citroën 16 108 178 80  
 DS 16 108 178 80  
 GENERAL MOTORS 93476595  
 Opel 16 759 576 80  
 Peugeot 16 112 422 80  
 Toyota SU001-A8529  
 Toyota SU001-B3186

Citroën 16 112 422 80  
 GENERAL MOTORS 16 759 576 80  
 Opel 16 108 178 80  
 Peugeot 16 108 178 80  
 Peugeot 16 75 957 680  
 Toyota SU001-B3184  
 Vauxhall 16 108 178 80

## Application info

Citroën Berlingo III (06/18--)  
 Citroën C4 Grand Picasso II (01/13--)  
 Citroën C4 SPACETOURER / GRAND SPACETOURER  
 (04/18--)  
 DS DS 9 (09/20--)  
 Opel Combo E (K9) (06/18--)  
 Peugeot 3008 II (05/16--)  
 Peugeot 308 II (09/13--)  
 Peugeot 5008 II (12/16--)  
 Peugeot Rifter (09/18--)  
 Vauxhall Astra Mk VIII (10/21--)  
 Vauxhall Grandland X (75) (06/17--)

Citroën C4 Cactus (09/14--)  
 Citroën C4 II / DS4 (02/09--)  
 Citroën C5 AIRCROSS (11/18--)  
 Opel Astra L (10/21--)  
 Opel Grandland X (75) (06/17--)  
 Peugeot 308 I (09/07--)  
 Peugeot 308 III (07/21--)  
 Peugeot 508 II (09/18--)  
 Toyota Proace City (10/19--)  
 Vauxhall Combo Mk IV (06/18--)

## Tie rod end

40-16 020 0001/HD

MTE0770HD

## Notes

Carbon Neutral  
 Front Axle Left  
 Length [mm] 215  
 Paired article number 40-16 020 0000/HD | MTE0769HD  
 Required quantity 1  
 Thread Size 1 M12x1,5  
 Thread Size 2 M14x1,5

reinforced version  
 replacement in pairs recommended





## References



Citroën 16 108 177 80	Citroën 16 112 421 80
DS 16 108 177 80	GENERAL MOTORS 1675957780
GENERAL MOTORS 93476594	Opel 16 108 177 80
Opel 16 759 577 80	Peugeot 16 108 177 80
Peugeot 16 112 421 80	Peugeot 16 75 957 780
Toyota SU001-A8528	Toyota SU001-B3183
Toyota SU001-B3185	Vauxhall 16 108 177 80

## Application info

Citroën Berlingo III (06/18--)	Citroën C4 Cactus (09/14--)
Citroën C4 Grand Picasso II (01/13--)	Citroën C4 II / DS4 (02/09--)
Citroën C4 SPACETOURER / GRAND SPACETOURER (04/18--)	Citroën C5 AIRCROSS (11/18--)
DS DS 9 (09/20--)	Opel Astra L (10/21--)
Opel Combo E (K9) (06/18--)	Opel Grandland X (75) (06/17--)
Peugeot 3008 II (05/16--)	Peugeot 308 I (09/07--)
Peugeot 308 II (09/13--)	Peugeot 308 III (07/21--)
Peugeot 5008 II (12/16--)	Peugeot 508 II (09/18--)
Peugeot Rifter (09/18--)	Toyota Proace City (10/19--)
Vauxhall Astra Mk VIII (10/21--)	Vauxhall Combo Mk IV (06/18--)
Vauxhall Grandland X (75) (06/17--)	



Tie rod end		40-16 020 0002	MTE0437
<b>Notes</b>			
	Front Axle Left		
Length [mm]	175		
Paired article number	11-16 020 0008   MTE0078		
Required quantity	1		
Thread Size 1	M10x1,25		
Thread Size 2	M14x1,5		
replacement in pairs recommended			
<b>References</b>			
Citroën 3817.55		Peugeot 3817.55	
<b>Application info</b>			
Citroën C2 / C3 I / Pluriel (02/02--)		Peugeot 1007 (04/05--)	
Tie rod end		40-16 020 0005	MTE0867
<b>Notes</b>			
	Front Axle Left		
Length [mm]	192		
Paired article number			
Required quantity	1		
Thread Size 1	10x1,25		
Thread Size 2	14x1,5		
replacement in pairs recommended			
<b>References</b>			
Citroën 16 231 410 80		DS 16 231 410 80	
<b>Application info</b>			
Citroën C3 II (09/09--)		Citroën C3 III (07/16--)	
DS DS 3 (04/15-07/19)			

Tie rod end		40-16 020 0006	MTE0868
<b>Notes</b>  Length [mm] 192 Paired article number Required quantity 1 Thread Size 1 10x1,25 Thread Size 2 14x1,5 replacement in pairs recommended			
<b>References</b> Citroën 16 231 411 80		DS 16 231 411 80	
<b>Application info</b> Citroën C3 II (09/09--) DS DS 3 (04/15-07/19)		Citroën C3 III (07/16--) 	
Tie rod end		40-16 020 5723/HD	MTE0438HD
<b>Notes</b>  Length [mm] 112 Paired article number 40-16 020 5724/HD   MTE0439HD Required quantity 1 Thread Size 1 M10x1,25 Thread Size 2 M14x1,5 reinforced version replacement in pairs recommended			
<b>References</b> CITROËN (DF-PSA) 3817.41 Citroën 94 580 841 80 Citroën 94 710 075 65 Peugeot 3817.30 Peugeot (DF-PSA) 3817.41		Citroën 3817.41 Citroën 94 710 005 65 Peugeot 3817.14 Peugeot 3817.41	

**Application info**

Citroën AX (07/86-12/98)

Citroën Saxo (02/96-04/04)

Citroën Xantia (03/93-04/03)

Peugeot 206 (08/98--)

Peugeot 605 (06/89-09/99)

Citroën C4 I / Coupe / Grand Picasso / Picasso / Stufenheck  
(11/04--)

Citroën XM (05/89-10/00)

Peugeot 106 (08/91-05/05)

Peugeot 307 (08/00-12/12)

**Tie rod end****40-16 020 5724/HD****MTE0439HD****Notes**

Carbon Neutral

Length [mm]

112

Paired article number

40-16 020 5723/HD | MTE0438HD

Required quantity

1

Thread Size 1

M10x1,25

Thread Size 2

M14x1,5

reinforced version

replacement in pairs recommended

**References**

CITROËN (DF-PSA) 3817.42

Citroën 3817.42

Citroën 94 710 006 65

Peugeot 3817.16

Peugeot 3817.42

Citroën 3817.31

Citroën 94 580 842 80

Citroën 94 710 074 65

Peugeot 3817.31

Peugeot (DF-PSA) 3817.42

**Application info**

Citroën AX (07/86-12/98)

Citroën Saxo (02/96-04/04)

Citroën Xantia (03/93-04/03)

Peugeot 206 (08/98--)



Peugeot 605 (06/89-09/99)

Citroën C4 I / Coupe / Grand Picasso / Picasso / Stufenheck  
(11/04--)

Citroën XM (05/89-10/00)



Peugeot 106 (08/91-05/05)

Peugeot 307 (08/00-12/12)

Tie rod end		416 020 0000/HD	MTE0552HD
<b>Notes</b>			
	Carbon Neutral		
	Front Axle Left		
	Front Axle Right		
Length [mm]	216		
Required quantity	2		
Thread Size 1	M12x1,5		
Thread Size 2	M14x1,5		
reinforced version			
replacement in pairs recommended			

<b>References</b>	Porsche 996 347 131 03	Porsche 996 347 131 04
-------------------	------------------------	------------------------

<b>Application info</b>	
Porsche 911 (996) (09/97-09/05)	Porsche 911 (997) (07/04-12/13)
Porsche Boxster (986) (09/96-12/04)	Porsche Boxster (987) (06/04-12/13)
Porsche Cayman (987) (11/05-12/13)	

Tie rod end		416 020 0002	MTE0830
<b>Notes</b>			
	Front Axle Left		
	Front Axle Right		
Length [mm]	216.5		
Required quantity	2		
Thread Size 1	M12x1,5		
Thread Size 2	M14x1,5		
replacement in pairs recommended			

<b>References</b>	Porsche 991 347 131 00
-------------------	------------------------

<b>Application info</b>	
Porsche 911 (991) (12/11--)	Porsche Boxster (981) (04/12--)
Porsche Boxster (982) (04/16--)	Porsche Cayman (981) (03/13--)
Porsche Cayman (982) (04/16--)	

## Tie rod end

416 020 0003/HD

MTE0875HD

## Notes

Carbon Neutral  
Front Axle Left  
Front Axle Right

Length [mm]

220

Required quantity

2

Thread Size 1

M14x1,5

Thread Size 2

M16x1,5

reinforced version

replacement in pairs recommended



## References

Porsche 958 423 811 A

## Application info

Porsche Cayenne III (9Y\_) (05/17--)

## Tie rod end

416 020 0004/HD

MTE0888HD

## Notes

Carbon Neutral  
Front Axle Right

Length [mm]

197

Paired article number

416 020 0005/HD | MTE0889HD

Required quantity

1

Thread Size 1

M12x1,5

Thread Size 2

M16x1,5

reinforced version

replacement in pairs recommended



## References

Porsche 971 423 812 B

## Application info

Porsche Panamera (971) (05/16--)

## Tie rod end

416 020 0005/HD

MTE0889HD

## Notes

Carbon Neutral  
 Front Axle Left  
 Length [mm] 197  
 Paired article number 416 020 0004/HD | MTE0888HD  
 Required quantity 1  
 Thread Size 1 M12x1,5  
 Thread Size 2 M16x1,5  
 reinforced version  
 replacement in pairs recommended



## References

Porsche 971 423 811 B

## Application info

Porsche Panamera (971) (05/16--)

## Tie rod end

416 020 0006/HD

MTE0923HD

## Notes

Carbon Neutral  
 Front Axle Right  
 Length [mm] 200  
 Paired article number 416 020 0007/HD | MTE0924HD  
 Required quantity 1  
 Thread Size 1 M12x1,5  
 Thread Size 2 M14x1,5  
 reinforced version  
 replacement in pairs recommended





## References

Porsche 970 347 132 01

## Application info

Porsche Panamera (970) (03/09-12/17)

Tie rod end		416 020 0007/HD	MTE0924HD
<b>Notes</b>  Carbon Neutral Front Axle Left Length [mm] 200 Paired article number Required quantity 1 Thread Size 1 M12x1,5 Thread Size 2 M14x1,5 reinforced version replacement in pairs recommended			
<b>References</b> Porsche 970 347 131 01			
<b>Application info</b> Porsche Panamera (970) (03/09-12/17)			
Tie rod end		44-16 020 0001	MTE0441
<b>Notes</b>  Front Axle Left Front Axle Right Length [mm] 119 Required quantity 2 Thread Size 1 M12x1,25 Thread Size 2 M14x1,5 replacement in pairs recommended			
<b>References</b> Chrysler 04762861AA Chrysler 4762861AA Chrysler 4762861 Dodge 4762861AA			
<b>Application info</b> Chrysler Neon (05/94-09/00) Chrysler PT Cruiser (06/00-12/10) Chrysler Voyager III/Caravan (01/95-12/01) Dodge Neon II (08/99--) Chrysler Neon II (08/99-12/06) Chrysler Voyager II (08/90-09/95) Dodge Neon I (05/94-08/99)			

## Tie rod end

44-16 020 0002

MTE0442

## Notes

	Front Axle Left
	Front Axle Right
Length [mm]	122.5
Required quantity	2
Thread Size 1	M12x1,25
Thread Size 2	M14x1,5
replacement in pairs recommended	







## References



Chrysler 5066373AA	Chrysler 5066373AB
Chrysler 5183761AB	Chrysler 5183761AC
Chrysler 5183761AD	Chrysler 68014944AA
Chrysler 68033171AA	Dodge 5183761AA
Dodge 5183761AB	Dodge 5183761AC
Dodge 5183761AD	Dodge 68141058AA
Fiat K05183761AA	Fiat K05183761AB
Fiat K05183761AC	Fiat K05183761AD
Fiat K68014944AA	Fiat K68141058AA
Jeep 5183761AA	Jeep 5183761AB
Jeep 5183761AD	Jeep 68141058AA
Lancia K05183761AD	Lancia K68156146AA





## Application info

Chrysler Sebring (JS) (09/06-12/10)	Chrysler Voyager IV/ Town Country (09/99-12/08)
Chrysler Voyager V/Town Country (10/07--)	Dodge Caliber (06/06--)
Dodge Caravan III (02/00-12/07)	Dodge Journey (06/08--)
Fiat Freemont (JC) (08/11--)	Jeep Compass (MK) (08/06--)
Jeep Patriot (MK) (02/07-12/17)	Lancia Flavia (03/12-12/14)
Lancia Voyager (09/11-12/14)	



Tie rod end		516 020 0002	MTE0445
<b>Notes</b>  Front Axle Left Front Axle Right for vehicles with power steering with right-hand thread  Length [mm] 74 Required quantity 2 Thread Size 1 M12x1,25 Thread Size 2 M12x1,25 replacement in pairs recommended		 	
<b>References</b> Mazda 8AB0-32-280 Mazda B455-32-280 Volvo 3480012		Mazda 8AB2-32-280 Volvo 3448334	
<b>Application info</b> Mazda 121 (DB) (11/90-05/97) Mazda 323 (BG) (04/87-09/00) Mazda MX-3 (EC) (05/91-09/98) Volvo 440 K / 460 L / 480 E (04/86-12/96)		Mazda 323 (BA) (09/92-12/03) Mazda Demio (01/96-07/03) Mazda RX-7 (FD) (07/92-08/02)	
Tie rod end		516 020 0008/HD	MTE0450HD
<b>Notes</b>  Carbon Neutral Front Axle Left  Length [mm] 258 Paired article number 516 020 0009/HD   MTE0451HD Required quantity 1 Thread Size 1 M12x1,75 Thread Size 2 M14x1,5 reinforced version replacement in pairs recommended		 	
<b>References</b> Volvo 274191 Volvo 274498 Volvo 3076806		Volvo 274351 Volvo 30760806 Volvo 31201228	
<b>Application info</b> Volvo XC70 I (10/97-10/07)		Volvo XC90 I (06/02-01/15)	

Tie rod end		516 020 0009/HD	MTE0451HD
<p><b>Notes</b></p> <p>Carbon Neutral Front Axle Right</p> <p>Length [mm] 258</p> <p>Paired article number 516 020 0008/HD   MTE0450HD</p> <p>Required quantity 1</p> <p>Thread Size 1 M12x1,75</p> <p>Thread Size 2 M14x1,5</p> <p>reinforced version</p> <p>replacement in pairs recommended</p>			
<p><b>References</b></p> <p>Volvo 274192 Volvo 274352</p> <p>Volvo 274499 Volvo 30760807</p> <p>Volvo 3076807 Volvo 31201229</p>			
<p><b>Application info</b></p> <p>Volvo XC70 I (10/97-10/07) Volvo XC90 I (06/02-01/15)</p>			
Tie rod end		516 020 0010	MTE0933
<p><b>Notes</b></p> <p>Front Axle Right</p> <p>Length [mm] 139</p> <p>Paired article number 516 020 0011   MTE0934</p> <p>Required quantity 1</p> <p>Thread Size 1 M12x1,75</p> <p>Thread Size 2 M18x1,5</p> <p>replacement in pairs recommended</p>			
<p><b>References</b></p> <p>Volvo 31681049 Volvo 32221688</p>			
<p><b>Application info</b></p> <p>Volvo S60 III (224) (02/19--) Volvo V60 II (02/18--)</p>			

Tie rod end		516 020 0011	MTE0934
<b>Notes</b>  Front Axle Left Length [mm] 139 Paired article number 516 020 0010   MTE0933 Required quantity 1 Thread Size 1 M12x1,75 Thread Size 2 M18x1,5 replacement in pairs recommended		 	
<b>References</b> Volvo 31681048 Volvo 32221687			
<b>Application info</b> Volvo S60 III (224) (02/19--) Volvo V60 II (02/18--)			
Tie rod end		516 020 0012/HD	MTE0717HD
<b>Notes</b>  Carbon Neutral Front Axle Right Length [mm] 109.5 Paired article number 516 020 0013/HD   MTE0718HD Required quantity 1 Thread Size 1 M10x1,5 Thread Size 2 M16x1,5 reinforced version replacement in pairs recommended		 	
<b>References</b> Volvo 31317819			
<b>Application info</b> Volvo V40 II (03/12--)			

## Tie rod end

516 020 0013/HD

MTE0718HD

## Notes

Carbon Neutral  
 Front Axle Left  
 Length [mm] 109.5  
 Paired article number 516 020 0012/HD | MTE0717HD  
 Required quantity 1  
 Thread Size 1 M10x1,5  
 Thread Size 2 M16x1,5  
 reinforced version  
 replacement in pairs recommended



## References

Volvo 31317781

## Application info

Volvo V40 II (03/12--)

## Tie rod end

516 020 0018

MTE0452

## Notes

Front Axle Left  
 with right-hand thread  
 Length [mm] 230  
 Paired article number 516 020 0019 | MTE0453  
 Required quantity 1  
 Thread Size 1 M12x1,75  
 Thread Size 2 M14x1,5  
 replacement in pairs recommended



## References

Volvo 274175



Volvo 274496



Volvo 30761719

## Application info

Volvo S60 I / V70 II (11/99-04/10)

Volvo S80 I (05/98-02/08)

Tie rod end		516 020 0018/HD	MTE0452HD
<b>Notes</b>  Carbon Neutral Front Axle Left with right-hand thread  Length [mm] 230 Paired article number 516 020 0019/HD   MTE0453HD Required quantity 1 Thread Size 1 M12x1,75 Thread Size 2 M14x1,5 reinforced version replacement in pairs recommended			
<b>References</b> Volvo 274175 Volvo 274496 Volvo 30761719			
<b>Application info</b> Volvo S60 I / V70 II (11/99-04/10) Volvo S80 I (05/98-02/08)			
Tie rod end		516 020 0019	MTE0453
<b>Notes</b>  Front Axle Right with right-hand thread  Length [mm] 230 Paired article number 516 020 0018   MTE0452 Required quantity 1 Thread Size 1 M12x1,75 Thread Size 2 M14x1,5 replacement in pairs recommended			
<b>References</b> Volvo 274176 Volvo 274497 Volvo 30761718			
<b>Application info</b> Volvo S60 I / V70 II (11/99-04/10) Volvo S80 I (05/98-02/08)			

Tie rod end		516 020 0019/HD	MTE0453HD
<b>Notes</b>  Carbon Neutral Front Axle Right with right-hand thread  Length [mm] 230 Paired article number 516 020 0018/HD   MTE0452HD Required quantity 1 Thread Size 1 M12x1,75 Thread Size 2 M14x1,5 reinforced version replacement in pairs recommended			
<b>References</b> Volvo 274176 Volvo 274497 Volvo 30761718			
<b>Application info</b> Volvo S60 I / V70 II (11/99-04/10) Volvo S80 I (05/98-02/08)			
Tie rod end		516 020 0020	MTE0454
<b>Notes</b>  Front Axle Left Front Axle Right with right-hand thread  Length [mm] 78 Required quantity 2 Thread Size 1 M10x1,25 Thread Size 2 M12x1,25 replacement in pairs recommended			
<b>References</b> Hyundai 56820-02500 Hyundai 56820-28000 Mitsubishi 4422A028 Mitsubishi 4422A063 Mitsubishi MB241982 Mitsubishi MB527169 Mitsubishi MB535996 Mitsubishi MB597605 Mitsubishi MB598023 Mitsubishi MB912076 Mitsubishi MR476457 Mitsubishi MR485672 Mitsubishi MR535996 Mitsubishi MR598023 Mitsubishi MR912076 Proton MB598023 Volvo 30870695 Volvo 30875012 Volvo 510185			

**Application info**

Hyundai Atos (01/97--)

Mitsubishi Carisma (07/95-06/06)

Mitsubishi Colt IV (03/92-04/96)

Mitsubishi Lancer III (11/83-08/92)

Mitsubishi Lancer V (07/91-10/03)

Mitsubishi Lancer VII (03/00-12/13)

Mitsubishi Space Star / Mirage (01/12--)

Volvo S/V 40 (07/95-12/04)

Hyundai Lantra I (10/90-11/95)

Mitsubishi Colt III (10/86-05/92)

Mitsubishi Colt V (09/95-08/04)

Mitsubishi Lancer IV (04/88-12/97)

Mitsubishi Lancer VI (09/95-12/03)

Mitsubishi Space Star (DG\_) (06/98-12/04)

Proton Persona 400 (01/94-02/08)

**Tie rod end****516 020 0029/HD****MTE0801HD****Notes**

Carbon Neutral

Front Axle Left

outer

Length [mm]

169

Paired article number

516 020 0030/HD | MTE0802HD

Required quantity

1

Thread Size 1

M12x1,75

Thread Size 2

M18x1,5

reinforced version

replacement in pairs recommended

**References**

Volvo 31429235

Volvo 31476317

Volvo 31476415

**Application info**

Volvo S90 II / V90 II (03/16--)

Volvo XC60 II (03/17--)

Volvo XC90 II (09/14--)

**Tie rod end****516 020 0030/HD****MTE0802HD****Notes**

Carbon Neutral

Front Axle Right

outer

Length [mm]

169

Paired article number

516 020 0029/HD | MTE0801HD

Required quantity

1

Thread Size 1

M12x1,75

Thread Size 2

M18x1,5

reinforced version

replacement in pairs recommended



**References**

Volvo 31429236

Volvo 31476416

Volvo 31476318

**Application info**

Volvo S90 II / V90 II (03/16--)

Volvo XC90 II (09/14--)

Volvo XC60 II (03/17--)

**Tie rod end**

516 020 0031

MTE0866

**Notes**

Front Axle Left

Length [mm]

155.5

Paired article number

Required quantity

1

Thread Size 1

M12x1,75

Thread Size 2

M18x1,5

replacement in pairs recommended

**References**

Volvo 31476319

Volvo 31658181

**Application info**

Volvo S90 II / V90 II (03/16--)

**Tie rod end**

516 020 0032

MTE0865

**Notes**

Front Axle Right

Length [mm]

155.5

Paired article number

Required quantity

1

Thread Size 1

M12x1,75

Thread Size 2

M18x1,5

replacement in pairs recommended

**References**

Volvo 31658182

**Application info**

Volvo S90 II / V90 II (03/16--)



















Tie rod end		53-16 020 0010	MTE0468
<p><b>Notes</b></p> <p>Front Axle Left with left-hand thread</p> <p>Length [mm] 86</p> <p>Paired article number 53-16 020 0011   MTE0469</p> <p>Required quantity 1</p> <p>Thread Size 1 M12X1,75</p> <p>Thread Size 2 W11/16"-16UNF</p> <p>replacement in pairs recommended</p>			
<p><b>References</b></p> <p>Land Rover NTC1887D</p>		<p>Land Rover RTC5870</p>	
<p><b>Application info</b></p> <p>Land Rover Defender I (05/90-05/16)</p>		<p>Land Rover Discovery I (06/89-12/98)</p>	
Tie rod end		53-16 020 0011	MTE0469
<p><b>Notes</b></p> <p>Front Axle Right with right-hand thread</p> <p>Length [mm] 86</p> <p>Paired article number 53-16 020 0010   MTE0468</p> <p>Required quantity 1</p> <p>Thread Size 1 M12x1,25</p> <p>Thread Size 2 W11/16"-16UNF</p> <p>replacement in pairs recommended</p>			
<p><b>References</b></p> <p>Land Rover NTC1886D</p>		<p>Land Rover RTC5869</p>	
<p><b>Application info</b></p> <p>Land Rover Defender I (05/90-05/16)</p>		<p>Land Rover Discovery I (06/89-12/98)</p>	

Tie rod end		53-16 020 0012	MTE0560
<b>Notes</b>  Front Axle Right Length [mm] 116 Paired article number 53-16 020 0013   MTE0561 Required quantity 1 Thread Size 1 M14x2,0 Thread Size 2 M18x1,5 replacement in pairs recommended			
<b>References</b> Jaguar T4N20184 Land Rover LR026267			
<b>Application info</b> Jaguar E-Pace (X540) (09/17--) Land Rover Range Rover Evoque I (06/11-12/19) Land Rover Discovery Sport (09/14--) 			
Tie rod end		53-16 020 0013	MTE0561
<b>Notes</b>  Front Axle Left Length [mm] 116 Paired article number 53-16 020 0012   MTE0560 Required quantity 1 Thread Size 1 M14x2,0 Thread Size 2 M18x1,5 replacement in pairs recommended			
<b>References</b> Jaguar T4N20185 Land Rover LR027570			
<b>Application info</b> Jaguar E-Pace (X540) (09/17--) Land Rover Range Rover Evoque I (06/11-12/19) Land Rover Discovery Sport (09/14--) 			

Tie rod end		53-16 020 0015	MTE0835
<b>Notes</b>  Front Axle Left Front Axle Right  Length [mm] 115 Required quantity 2 Thread Size 1 M14x2,0 Thread Size 2 M16x1,5 replacement in pairs recommended			
<b>References</b> Land Rover LR059261			
<b>Application info</b> Land Rover Discovery V (09/16--) Land Rover Range Rover Sport II (04/13--) Land Rover Range Rover IV (08/12--)			
Tie rod end		53-16 020 0016	MTE0871
<b>Notes</b>  Front Axle Left Front Axle Right  Length [mm] 210 Required quantity 2 Thread Size 1 M14x2,0 Thread Size 2 M14x1,5 replacement in pairs recommended			
<b>References</b> Jaguar T4A12525 Land Rover LR090883 Jaguar T4A28746 Land Rover LR111480			
<b>Application info</b> Jaguar F-Pace (X761) (09/15--) Land Rover Range Rover Velar (03/17--) Jaguar I-Pace (X590) (02/18--)			



## Tie rod end

53-16 020 0017/HD

MTE0756HD

## Notes

Carbon Neutral  
Front Axle Left  
Front Axle Right

Length [mm]

102.5

Required quantity

2

Thread Size 1

M14x2,0

Thread Size 2

M14x1,5

reinforced version

replacement in pairs recommended



## References

Land Rover LR033534

## Application info

Land Rover Range Rover IV (08/12--)

Land Rover Range Rover Sport II (04/13--)

## Tie rod end

53-16 020 0018/HD

MTE0825HD

## Notes

Carbon Neutral  
Front Axle Left  
Front Axle Right

Length [mm]

89

Required quantity

2

Thread Size 1

M12x1,75

Thread Size 2

M16x1,5

reinforced version

replacement in pairs recommended





## References



Land Rover LR010671

Land Rover QJB500010

## Application info

Land Rover Discovery III (07/04-09/09)

Tie rod end		53-16 020 0019	MTE0959
<b>Notes</b>  Front Axle Left Front Axle Right  Length [mm] 120 Required quantity 2 Thread Size 1 M14x2,0 Thread Size 2 M16x1,5 replacement in pairs recommended			
<b>References</b> Jaguar J9C22780 Land Rover LR135927		Land Rover LR125333	
<b>Application info</b> Jaguar E-Pace (X540) (09/17--) Land Rover Range Rover Evoque II (12/18--)		Land Rover Discovery Sport (09/14--)	
Tie rod end		53-16 020 0020/HD	MTE0998HD
<b>Notes</b>  Front Axle Left Front Axle Right  Length [mm] 135 Required quantity 2 Thread Size 1 M14x2 Thread Size 2 M16x1,5 reinforced version replacement in pairs recommended			
<b>References</b> Land Rover LR129166			
<b>Application info</b> Land Rover Defender II (09/19--)		Land Rover Discovery V (09/16--)	

Tie rod end		57-16 020 0001	MTE0831
<p><b>Notes</b></p> <p>Front Axle Left outer</p> <p>Length [mm] 94</p> <p>Paired article number 57-16 020 0002   MTE0832</p> <p>Required quantity 1</p> <p>Thread Size 1 M12X1,5</p> <p>Thread Size 2 M16X1,5</p> <p>replacement in pairs recommended</p>			
<p><b>References</b></p> <p>Jeep 68224937AA Jeep K68224937AA</p>			
<p><b>Application info</b></p> <p>Jeep Cherokee (KL) (06/13--)</p>			
Tie rod end		57-16 020 0002	MTE0832
<p><b>Notes</b></p> <p>Front Axle Right outer</p> <p>Length [mm] 94</p> <p>Paired article number 57-16 020 0001   MTE0831</p> <p>Required quantity 1</p> <p>Thread Size 1 M12x1,5</p> <p>Thread Size 2 M16x1,5</p> <p>replacement in pairs recommended</p>			
<p><b>References</b></p> <p>Jeep 68224936AA Jeep K68224936AA</p>			
<p><b>Application info</b></p> <p>Jeep Cherokee (KL) (06/13--)</p>			

## Tie rod end

616 020 0001

MTE0474

## Notes

Front Axle Left  
Front Axle Right

Length [mm] 70  
Required quantity 2  
Thread Size 1 M10x1,5  
Thread Size 2 M12x1,5  
replacement in pairs recommended



## References

GENERAL MOTORS 07840452  
GENERAL MOTORS 26087868  
GENERAL MOTORS 93388621  
Opel 16 03 009  
Opel 3 24 050  
Smart 451 338 01 37  
Smart A 451 338 01 37  
Vauxhall 16 03 009  
Vauxhall 3 24 050

GENERAL MOTORS 26011925  
GENERAL MOTORS 93192419  
Opel 03 24 050  
Opel 16 03 645  
Smart 451 338 00 37  
Smart A 451 338 00 37  
Vauxhall 03 24 050  
Vauxhall 16 03 645

## Application info

Opel Corsa A (09/82-09/94)  
Opel Corsa C / Combo / Tigra (09/00--)  
Vauxhall Combo Mk I (07/94-10/01)  
Vauxhall Corsa Mk I Tigra (12/92-12/00)  
Vauxhall Nova (09/82-12/93)

Opel Corsa B / Combo / Tigra (03/93-12/02)  
Smart Fortwo II (01/07--)  
Vauxhall Combo Mk II (09/01-02/12)  
Vauxhall Corsa Mk II / Tigra / Combo (08/00-02/12)

## Tie rod end

616 020 0002

MTE0475

## Notes

Front Axle Left  
Front Axle Right

Length [mm] 68  
Required quantity 2  
Thread Size 1 M10x1,5  
Thread Size 2 M14x1,5  
replacement in pairs recommended



**References**

GENERAL MOTORS 26102923  
 Opel 16 03 240  
 Vauxhall 16 03 240

GENERAL MOTORS 93192417  
 Opel 16 03 430  
 Vauxhall 16 03 430

**Application info**

Opel Meriva A (05/03-05/10)

Vauxhall Meriva Mk I A (01/03-06/10)

**Tie rod end****616 020 0005/HD****MTE0476HD****Notes**

Carbon Neutral  
 Front Axle Left  
 Length [mm] 140  
 Paired article number 616 020 0011/HD | MTE0482HD  
 Required quantity 1  
 Thread Size 1 M12x1,5  
 Thread Size 2 M14x1,5  
 reinforced version  
 replacement in pairs recommended

**References**



GENERAL MOTORS 93179559  
 GENERAL MOTORS 93186333  
 Opel 16 03 258  
 Opel 16 03 289  
 Vauxhall 16 03 258  
 Vauxhall 16 03 289



GENERAL MOTORS 93181232  
 GENERAL MOTORS 93196780  
 Opel 16 03 266  
 Opel 16 09 013  
 Vauxhall 16 03 266  
 Vauxhall 16 09 013

**Application info**

Opel Astra H / Zafira B (01/04-05/19)  
 Opel Meriva B (06/10-03/17)  
 Vauxhall Insignia Mk I A (07/08-05/17)  
 Vauxhall Zafira Mk II (04/05-11/14)

Opel Astra J (12/06--)  
 Vauxhall Astra Mk V (01/04--)  
 Vauxhall Meriva Mk II B (06/10--)

Tie rod end		616 020 0006	MTE0477
<b>Notes</b>  Front Axle Left Length [mm] 220 Paired article number 616 020 0008   MTE0479 Required quantity 1 Thread Size 1 M14x1,5 Thread Size 2 M16x1,5 replacement in pairs recommended			
<b>References</b> GENERAL MOTORS 9161562 Opel 45 01 262 Vauxhall 45 01 262		Nissan 48520-00QAH Renault 7701470363	
<b>Application info</b> Nissan Interstar I (X70) (04/02--) Renault Master II (03/98--)		Opel Movano A (07/98--) Vauxhall Movano Mk I (10/98-12/10)	
Tie rod end		616 020 0007	MTE0478
<b>Notes</b>  Front Axle Left Front Axle Right Length [mm] 75 Required quantity 2 Thread Size 1 M14x1,5 Thread Size 2 M14x1,5 replacement in pairs recommended			
<b>References</b> GENERAL MOTORS 900907 Opel 09 00 907 Vauxhall 09 00 907		GENERAL MOTORS 97184821 Opel 9 00 907 Vauxhall 9 00 907	
<b>Application info</b> Opel Frontera B / Monterey B (07/98-07/04)		Vauxhall Frontera Mk II (10/98-10/04)	

Tie rod end		616 020 0008	MTE0479
<p><b>Notes</b></p> <p>Front Axle Right</p> <p>Length [mm] 223</p> <p>Paired article number 616 020 0006   MTE0477</p> <p>Required quantity 1</p> <p>Thread Size 1 M14x1,5</p> <p>Thread Size 2 M16x1,5</p> <p>replacement in pairs recommended</p>			
<p><b>References</b></p> <p>GENERAL MOTORS 9161563 Nissan 48520-00QAJ</p> <p>Opel 45 01 263 Renault 7701470364</p> <p>Vauxhall 45 01 263</p>			
<p><b>Application info</b></p> <p>Nissan Interstar I (X70) (04/02--) Opel Movano A (07/98--)</p> <p>Renault Master II (03/98--) Vauxhall Movano Mk I (10/98-12/10)</p>			
Tie rod end		616 020 0011/HD	MTE0482HD
<p><b>Notes</b></p> <p>Carbon Neutral</p> <p>Front Axle Right</p> <p>Length [mm] 140</p> <p>Paired article number 616 020 0005/HD   MTE0476HD</p> <p>Required quantity 1</p> <p>Thread Size 1 M12x1,5</p> <p>Thread Size 2 M14x1,5</p> <p>reinforced version</p> <p>replacement in pairs recommended</p>			
<p><b>References</b></p> <p>GENERAL MOTORS 93179558 GENERAL MOTORS 93181233</p> <p>GENERAL MOTORS 93186332 GENERAL MOTORS 93196779</p> <p>Opel 16 03 257 Opel 16 03 267</p> <p>Opel 16 03 288 Opel 16 09 012</p> <p>Vauxhall 16 03 257 Vauxhall 16 03 267</p> <p>Vauxhall 16 03 288 Vauxhall 16 09 012</p>			

**Application info**

Opel Astra H / Zafira B (01/04-05/19)

Opel Meriva B (06/10-03/17)

Vauxhall Insigna Mk I A (07/08-05/17)

Vauxhall Zafira Mk II (04/05-11/14)

Opel Astra J (12/06--)

Vauxhall Astra Mk V (01/04--)

Vauxhall Meriva Mk II B (06/10--)

**Tie rod end****616 020 0012****MTE0483****Notes**Front Axle Left  
Front Axle Right

Length [mm]

74

Required quantity

2

Thread Size 1

M12x1,5

Thread Size 2

M14x1,5

replacement in pairs recommended

**References**

Chevrolet 95932779

GENERAL MOTORS 95932790

Opel 16 09 206

Opel 9 20 010

Vauxhall 48 03 429

Chevrolet 96626667

GENERAL MOTORS 96626667

Opel 48 03 429

Vauxhall 16 09 206

Vauxhall 9 20 010

**Application info**

Chevrolet Captiva I (06/06--)

Opel Antara (05/06--)

Vauxhall Antara (08/06--)

Chevrolet Trax (12/12--)

Opel Mokka A (06/12--)

Vauxhall Mokka A (06/12--)

**Tie rod end****616 020 0015/HD****MTE0484HD****Notes**Carbon Neutral  
Front Axle Left  
Front Axle Right

Length [mm]

115

Required quantity

2

Thread Size 1

M12x1,75

Thread Size 2

M16x1,5

reinforced version

replacement in pairs recommended





**References**

Buick 13272000	Chevrolet 13278359
Chevrolet 13286686	Chevrolet 13396771
GENERAL MOTORS 13272000	GENERAL MOTORS 13278359
GENERAL MOTORS 13286686	GENERAL MOTORS 13372000
GENERAL MOTORS 920008	Opel 09 20 008
Opel 13278359	Opel 16 09 026
Opel 66 06 031	Opel 9 20 008
Saab 13 27 2000	Vauxhall 16 09 026
Vauxhall 66 06 031	Vauxhall 9 20 008

**Application info**

Chevrolet Cruze (J300, J305) (07/00--)	Chevrolet Cruze (J308) (08/12--)
Chevrolet Orlando (J309) (12/10--)	Chevrolet Volt (04/11--)
Opel Ampera (11/11-03/15)	Opel Astra J (12/06--)
Opel Insignia A (07/08-03/17)	Opel Zafira C (Tourer) (10/11--)
Saab 9-5 (YS3G) (01/10-01/12)	Vauxhall Ampera (03/12--)
Vauxhall Astra Mk VI (12/09-10/15)	Vauxhall Insignia Mk I A (07/08-05/17)
Vauxhall Zafira Mk III (10/11-08/18)	

**Tie rod end****616 020 0016****MTE0485****Notes**



	Front Axle Left
Length [mm]	160
Paired article number	616 020 0017   MTE0486
Required quantity	1
Thread Size 1	M12x1,75
Thread Size 2	M16x1,5
replacement in pairs recommended	

**References**

GENERAL MOTORS 13337880	GENERAL MOTORS 13354538
Opel 16 09 137	Opel 16 09 185
Vauxhall 16 09 137	Vauxhall 16 09 185

**Application info**

Opel Astra J (12/06--)	Opel Cascada (03/13-04/19)
Vauxhall Astra Mk VI (12/09-10/15)	Vauxhall Cascada (02/13--)

Tie rod end		616 020 0017	MTE0486
<b>Notes</b>  Front Axle Right Length [mm] 160 Paired article number 616 020 0016   MTE0485 Required quantity 1 Thread Size 1 M12x1,75 Thread Size 2 M16x1,5 replacement in pairs recommended			
<b>References</b> GENERAL MOTORS 13337882 Opel 16 09 164 Vauxhall 16 09 164		GENERAL MOTORS 13354540 Opel 16 09 186 Vauxhall 16 09 186	
<b>Application info</b> Opel Astra J (12/06--) Vauxhall Astra Mk VI (12/09-10/15)		Opel Cascada (03/13-04/19) Vauxhall Cascada (02/13--) 	
Tie rod end		616 020 0019	MTE0487
<b>Notes</b>  Front Axle Left Front Axle Right Length [mm] 89 Required quantity 2 Thread Size 1 M12x1,75 Thread Size 2 M14x1,5 replacement in pairs recommended			
<b>References</b> Chevrolet 9 20 011 Chevrolet 95915222 GENERAL MOTORS 95915222 Opel 9 20 011 Vauxhall 9 20 011		Chevrolet 95914910 GENERAL MOTORS 95914910 Opel 16 09 203 Vauxhall 16 09 203	
<b>Application info</b> Chevrolet Trax (12/12--) Vauxhall Mokka A (06/12--) 		Opel Mokka A (06/12--) 	

## Tie rod end

616 020 0023

MTE0736

## Notes

Front Axle Left  
Front Axle Right

Length [mm] 136  
Required quantity 2  
Thread Size 1 M12x1,5  
Thread Size 2 M14x1,5  
replacement in pairs recommended



## References

Chevrolet 26059294  
Chevrolet 93186537  
GENERAL MOTORS 9118127  
Opel 16 03 214  
Opel 16 03 542  
Vauxhall 16 03 215

Chevrolet 9118127  
GENERAL MOTORS 26059294  
GENERAL MOTORS 93186537  
Opel 16 03 215  
Vauxhall 16 03 214  
Vauxhall 16 03 542

## Application info

Chevrolet Zafira (F75) (02/99-12/12)  
Vauxhall Astra Mk II (09/84-09/93)  
Vauxhall Zafira Mk I (11/98-08/05)

Opel Astra G / Astra Classic / Zafira A (02/98-12/09)  
Vauxhall Astra Mk IV (01/93-08/06)

## Tie rod end

616 020 0024/HD

MTE0780HD

## Notes

Carbon Neutral  
Front Axle Right  
outer

Length [mm] 83  
Paired article number 616 020 0025/HD | MTE0781HD  
Required quantity 1  
Thread Size 1 12x1,75  
Thread Size 2 14x1,5  
reinforced version  
replacement in pairs recommended



## References

GENERAL MOTORS 9 20 014  
Opel 9 20 014  
Vauxhall 9 20 014

GENERAL MOTORS 95371539  
Opel 95371539  
Vauxhall 95 37 1539

**Application info**

Opel Karl (01/15-03/19)

Vauxhall Viva (01/15-03/19)

**Tie rod end****616 020 0025/HD****MTE0781HD****Notes**Carbon Neutral  
Front Axle Left  
outer

Length [mm]

83

Paired article number

616 020 0024/HD | MTE0780HD

Required quantity

1

Thread Size 1

12x1,75

Thread Size 2

14x1,5

reinforced version

replacement in pairs recommended

**References**

GENERAL MOTORS 9 20 013

GENERAL MOTORS 95371538

Opel 9 20 013

Opel 95371538

Vauxhall 9 20 013

Vauxhall 95 37 1538

**Application info**

Opel Karl (01/15-03/19)

Vauxhall Viva (01/15-03/19)

**Tie rod end****616 020 0026/HD****MTE0777HD****Notes**Carbon Neutral  
Front Axle Right  
outer

Length [mm]

142

Paired article number

616 020 0027/HD | MTE0778HD

Required quantity

1

Thread Size 1

12x1,75

Thread Size 2

14x1,5

reinforced version

replacement in pairs recommended

**References**

GENERAL MOTORS 39008083



Opel 39008083





Vauxhall 39 00 8083

**Application info**

Opel Astra K (06/15--)

Vauxhall Astra Mk VII (07/15--)

Tie rod end		616 020 0027/HD	MTE0778HD
<b>Notes</b>  Carbon Neutral Front Axle Left outer Length [mm] 142 Paired article number 616 020 0026/HD   MTE0777HD Required quantity 1 Thread Size 1 12x1,75 Thread Size 2 14x1,5 reinforced version replacement in pairs recommended			
<b>References</b> GENERAL MOTORS 39008084 Opel 39008084 Vauxhall 39 00 8084			
<b>Application info</b> Opel Astra K (06/15--) Vauxhall Astra Mk VII (07/15--)			
Tie rod end		616 020 0028/HD	MTE0763HD
<b>Notes</b>  Carbon Neutral Front Axle Left Front Axle Right Length [mm] 74 Required quantity 2 Thread Size 1 M12x1,5 Thread Size 2 M14x1,5 reinforced version replacement in pairs recommended			
<b>References</b> Chevrolet 93746130 Chevrolet 95940332 GENERAL MOTORS 93746130 GENERAL MOTORS 95940332 Opel 48 19 273 Opel 48 19 620 Vauxhall 48 19 273 Vauxhall 48 19 620			
<b>Application info</b> Chevrolet Captiva I (06/06--) Opel Antara (05/06--) Vauxhall Antara (08/06--)			

Tie rod end		616 020 0029/HD	MTE0869HD
<b>Notes</b>  Carbon Neutral Front Axle Left  Length [mm] 186 Paired article number 616 020 0030/HD   MTE0870HD Required quantity 1 Thread Size 1 12x1,75 Thread Size 2 14x1,5 reinforced version replacement in pairs recommended		 	
<b>References</b> GENERAL MOTORS 23449522 Opel 23449522 Vauxhall 23 44 9522			
<b>Application info</b> Opel Insignia B (03/17--) Vauxhall Insignia Mk II B (03/17--)			
Tie rod end		616 020 0030/HD	MTE0870HD
<b>Notes</b>  Carbon Neutral Front Axle Right  Length [mm] 186 Paired article number 616 020 0029/HD   MTE0869HD Required quantity 1 Thread Size 1 12x1,75 Thread Size 2 14x1,5 reinforced version replacement in pairs recommended		 	
<b>References</b> GENERAL MOTORS 23449523 Opel 23449523 Vauxhall 23 44 9523			
<b>Application info</b> Opel Insignia B (03/17--) Vauxhall Insignia Mk II B (03/17--)			

## Tie rod end

616 020 0031

MTE0890

## Notes

Front Axle Left  
Front Axle Right

Length [mm] 155  
Required quantity 2  
Thread Size 1 10x1,25  
Thread Size 2 14x1,5  
replacement in pairs recommended



## References

Citroën 16 310 569 80  
Opel 35 56 146

GENERAL MOTORS 3556146  
Vauxhall 35 56 146

## Application info

Citroën C3 AIRCROSS II (06/17--)  
Vauxhall Crossland X (03/17--)

Opel Crossland X (03/17--)

## Tie rod end

616 020 5562

MTE0494

## Notes

Front Axle Left  
with right-hand thread

Length [mm] 66  
Paired article number 616 020 5565 | MTE0495  
Required quantity 1  
Thread Size 1 M12x1,5  
Thread Size 2 M16x2,0  
replacement in pairs recommended



## References

GENERAL MOTORS 90350447  
Opel 03 24 053  
Opel 3 24 053  
Saab 42 42 749  
Vauxhall 03 24 055  
Vauxhall 3 24 055

GENERAL MOTORS 90369704  
Opel 03 24 055  
Opel 3 24 055  
Vauxhall 03 24 053  
Vauxhall 3 24 053

**Application info**

Opel Astra F (09/91-01/05)  
 Opel Vectra A (04/88-12/95)  
 Saab 900 II (07/93-04/99)  
 Vauxhall Calibra Mk I (06/90-07/97)

Opel Calibra (08/89-07/97)  
 Saab 9-3 (YS3D) (02/98-08/03)  
 Vauxhall Astra Mk III (01/91-03/01)  
 Vauxhall Cavalier Mk III (08/88-11/95)

**Tie rod end****616 020 5565****MTE0495****Notes**

Front Axle Right  
 with left-hand thread

Length [mm] 66

Paired article number 616 020 5562 | MTE0494

Required quantity 1

Thread Size 1 M12x1,5

Thread Size 2 M16x2,0

replacement in pairs recommended

**References**

GENERAL MOTORS 90350446  
 GENERAL MOTORS 90369705  
 Opel 03 24 056  
 Opel 3 24 056  
 Vauxhall 03 24 054  
 Vauxhall 3 24 054

GENERAL MOTORS 90350448  
 Opel 03 24 054  
 Opel 3 24 054  
 Saab 42 42 756  
 Vauxhall 03 24 056  
 Vauxhall 3 24 056

**Application info**

Opel Astra F (09/91-01/05)  
 Opel Vectra A (04/88-12/95)  
 Saab 900 II (07/93-04/99)  
 Vauxhall Calibra Mk I (06/90-07/97)

Opel Calibra (08/89-07/97)  
 Saab 9-3 (YS3D) (02/98-08/03)  
 Vauxhall Astra Mk III (01/91-03/01)  
 Vauxhall Cavalier Mk III (08/88-11/95)

**Tie rod end****616 020 5570****MTE0496****Notes**

Front Axle Left  
 Front Axle Right

Length [mm] 78

Required quantity 2

Thread Size 1 M10x1,5

Thread Size 2 M12x1,5

replacement in pairs recommended





**References**

GENERAL MOTORS 26065265

Opel 3 24 066

Vauxhall 3 24 066

Opel 03 24 066

Vauxhall 03 24 066

**Application info**

Opel Corsa B / Combo / Tigra (03/93-12/02)

Vauxhall Corsa Mk I Tigra (12/92-12/00)

Vauxhall Combo Mk I (07/94-10/01)

**Tie rod end****616 020 5588****MTE0498****Notes**

Front Axle Right

outer

with left-hand thread

233

Length [mm]

Paired article number

616 020 5589 | MTE0499

Required quantity

1

Thread Size 1

M12x1,5

Thread Size 2

M14x1,5

replacement in pairs recommended

**References**

GENERAL MOTORS 90473812

GENERAL MOTORS 90510654

Opel 03 22 180

Opel 03 24 155

Opel 3 24 060

Vauxhall 03 22 180

Vauxhall 03 24 155

Vauxhall 3 24 060

GENERAL MOTORS 9051054

GENERAL MOTORS 93169283

Opel 03 24 060

Opel 3 22 180

Opel 3 24 155

Vauxhall 03 24 060

Vauxhall 3 22 180

Vauxhall 3 24 155

**Application info**

Opel Omega B (03/94-12/05)

Vauxhall Omega Mk II (12/93-07/03)

## Tie rod end

616 020 5589

MTE0499

## Notes

Front Axle Left  
outer  
with right-hand thread

Length [mm]

233

Paired article number

616 020 5588 | MTE0498

Required quantity

1

Thread Size 1

M12x1,5

Thread Size 2

M14x1,5

replacement in pairs recommended



## References

GENERAL MOTORS 90473811

Opel 03 22 179

Opel 3 22 004

Opel 3 24 059

Vauxhall 03 24 059

Vauxhall 3 24 059

GENERAL MOTORS 90510653

Opel 03 24 059

Opel 3 22 179

Vauxhall 03 22 179

Vauxhall 3 22 179

## Application info

Opel Omega B (03/94-12/05)

Vauxhall Omega Mk II (12/93-07/03)

## Tie rod end

616 020 6002/HD

MTE0500HD

## Notes

Carbon Neutral  
Front Axle Left  
Front Axle Right

Length [mm]

136

Required quantity

2

Thread Size 1

M12x1,5

Thread Size 2

M14x1,5

reinforced version

replacement in pairs recommended



## References

Chevrolet 26059294

Chevrolet 93186537

GENERAL MOTORS 9118127

Opel 16 03 214

Opel 16 03 542

Vauxhall 16 03 215

Chevrolet 9118127

GENERAL MOTORS 26059294

GENERAL MOTORS 93186537

Opel 16 03 215

Vauxhall 16 03 214

Vauxhall 16 03 542

**Application info**

Chevrolet Zafira (F75) (02/99-12/12)  
 Vauxhall Astra Mk II (09/84-09/93)  
 Vauxhall Zafira Mk I (11/98-08/05)

Opel Astra G / Astra Classic / Zafira A (02/98-12/09)  
 Vauxhall Astra Mk IV (01/93-08/06)

**Tie rod end****70-16 020 0002/HD****MTE0976HD****Notes**

Carbon Neutral  
 Front Axle Left  
 Front Axle Right

Length [mm]

150

Required quantity

2

Thread Size 1

M14x1,5

Thread Size 2

M14x1,5

reinforced version

replacement in pairs recommended

**References**

TESLA 1044831-00-E  
 TESLA 1044841-00-E

TESLA 1044831-00-H

**Application info**

TESLA Model 3 (01/17--)

TESLA Model Y (03/19--)

**Tie rod end****70-16 020 0004/HD****MTE0995HD****Notes**

Front Axle Left  
 Front Axle Right

Length [mm]

193.5

Required quantity

2

Thread Size 1

M14x2,0

Thread Size 2

M14x1,5

reinforced version

replacement in pairs recommended



**References**



TESLA 1027841-00-B

**Application info**

TESLA Model S (09/12--)

TESLA Model X (09/13--)

Tie rod end		716 020 0004	MTE0501
<b>Notes</b>  Length [mm] 94 Paired article number 716 020 0016   MTE0511 Required quantity 1 Thread Size 1 M10x1,5 Thread Size 2 M14x1,5 replacement in pairs recommended			
<b>References</b> Ford 1 202 549 Mazda DD32-32 290		Ford 2S6J-3290-AC Mazda DE90-32-290	
<b>Application info</b> Ford Fiesta V / Fusion (11/01-12/14)		Mazda 2 (DY) (02/03-06/07)	
Tie rod end		716 020 0006	MTE0502
<b>Notes</b>  Length [mm] 68 Required quantity 2 Thread Size 1 M10x1 Thread Size 2 1/2"-20 UNF replacement in pairs recommended			
<b>References</b> Ford 1 032 567 Ford 1 034 417 Ford 6 969 518 Ford 94FB-3289-A2A Ford 97KB-3289-BA		Ford 1 032 689 Ford 6 969 517 Ford 94FB-3289-A1A Ford 94FX-3270-AA Ford 97KX-3270-AA	
<b>Application info</b> Ford Fiesta III (01/89-01/97)		Ford KA I (09/96-11/08)	

Tie rod end		716 020 0007	MTE0503
<b>Notes</b>  Front Axle Left with right-hand thread  Length [mm] 74 Paired article number 716 020 0008   MTE0504 Required quantity 1 Thread Size 1 M10x1,5 Thread Size 2 M14x2,0 replacement in pairs recommended			
<b>References</b> Ford 1 074 306 Ford 1 107 015 Ford 98AG-3290-AA Ford 98AX-3270-BA			
<b>Application info</b> Ford Focus I (08/98-11/09)			
Tie rod end		716 020 0008	MTE0504
<b>Notes</b>  Front Axle Right 74 Paired article number 716 020 0007   MTE0503 Required quantity 1 Thread Size 1 M10x1,5 Thread Size 2 M14x2,0 replacement in pairs recommended			
<b>References</b> Ford 1 074 305 Ford 1 107 013 Ford 98AG-3289-AA Ford 98AX-3270-AA			
<b>Application info</b> Ford Focus I (08/98-11/09)			

## Tie rod end

716 020 0014

MTE0509

## Notes

Front Axle Left  
Front Axle Right

Length [mm] 92  
Required quantity 2  
Thread Size 1 M10x1,5  
Thread Size 2 M16x1,5  
replacement in pairs recommended



## References

Ford 1 138 313	Ford 1 138 314
Ford 1S7C-3290-AB	Ford 1S7C-3290-BB
Ford 1S7J-3290-AB	Ford 1S7J-3290-BB
Ford 4 118 933	Ford 4 118 934
Ford (Chanagan) 1S7C-3290-AB	Ford (Chanagan) 1S7J-3290-AB
Jaguar 1X433289AB	Jaguar C2S12013
Jaguar C2S47357	

## Application info

Ford Mondeo III (10/00-09/07)      Jaguar X-Type (03/01-12/09)

## Tie rod end

716 020 0015

MTE0510

## Notes

Front Axle Left  
Front Axle Right

Length [mm] 90  
Required quantity 2  
Thread Size 1 M14x2,0  
Thread Size 2 M16x1,5  
replacement in pairs recommended



## References

Ford 1 138 275	Ford 1 370 741
Ford 1 490 759	Ford 1 736 669
Ford 1 743 642	Ford 1 763 989
Ford 4 047 091	Ford 6C11-3289-AA
Ford 6C11-3289-AB	Ford 6C11-3289-AC
Ford 6C1J-3289-AA	Ford BK21-3289-AA
Ford YC15-3289-AA	Ford YC1J-3289-AA

**Application info**

Ford Tourneo '12 (04/12--)  
 Ford Transit '06 (04/06-12/14)  
 Ford Transit Custom '12 (04/12--)

Ford Transit '00 (01/00-05/06)  
 Ford Transit '14 (08/13--)

**Tie rod end**

716 020 0016

MTE0511

**Notes**

Front Axle Right  
 Length [mm] 94  
 Paired article number 716 020 0004 | MTE0501  
 Required quantity 1  
 Thread Size 1 M10x1,5  
 Thread Size 2 M14x1,5  
 replacement in pairs recommended



**References**

Ford 1 202 548  
 Mazda DD32-32 280

Ford 2S6J-3289-AC  
 Mazda DE90-32-280

**Application info**

Ford Fiesta V / Fusion (11/01-12/14)

Mazda 2 (DY) (02/03-06/07)

**Tie rod end**

716 020 0017/HD

MTE0512HD

**Notes**

Carbon Neutral  
 Front Axle Right  
 Length [mm] 100  
 Paired article number 716 020 0018/HD | MTE0513HD  
 Required quantity 1  
 Thread Size 1 M10x1,5  
 Thread Size 2 M16x1,5  
 reinforced version  
 replacement in pairs recommended



**References**

Ford 1 251 925	Ford 1 306 177
Ford 1 315 074	Ford 1 317 446
Ford 1 328 877	Ford 1 388 549
Ford 1 541 652	Ford 1 730 933
Ford 1 894 033	Ford 3M51-3289-AC
Ford 3M51-3290-AA	Ford 3M51-3290-AB
Ford 3M51-3C367-AA	Ford 3M51-3C367-AB
Ford 4M51-3289-AB	Ford 4M51-3289-AC
Ford 4M51-3289-AD	Ford EV61-3289-AA
Volvo 274500	Volvo 30723104
Volvo 31201412	

**Application info**

Ford C-Max I (02/07-09/10)	Ford Focus II (10/03--)
Ford Focus III (07/10--)	Volvo C30 (09/06-12/13)
Volvo C70 II (03/06-12/13)	Volvo S40 II / V50 (12/03-12/12)

**Tie rod end****716 020 0018/HD****MTE0513HD****Notes**

Carbon Neutral  
 Front Axle Left  
 Length [mm] 100  
 Paired article number 716 020 0017/HD | MTE0512HD  
 Required quantity 1  
 Thread Size 1 M10x1,5  
 Thread Size 2 M16x1,5

reinforced version  
 replacement in pairs recommended

**References**

Ford 1 251 924	Ford 1 306 176
Ford 1 315 083	Ford 1 317 447
Ford 1 328 881	Ford 1 404 785
Ford 1 541 811	Ford 1 730 934
Ford 1 894 034	Ford 3M3C 437A A
Ford 3M51-3289-AA	Ford 3M51-3289-AB
Ford 3M51-3290-AC	Ford 3M51-3C437-AA
Ford 3M51-3C437-AB	Ford 4M51-3290-AB
Ford 4M51-3290-AC	Ford 4M51-3290-AD
Ford EV61-3290-AA	Volvo 274501
Volvo 30723103	Volvo 31201413



**Application info**

Ford C-Max I (02/07-09/10)  
 Ford Focus III (07/10--)  
 Volvo C70 II (03/06-12/13)

Ford Focus II (10/03--)  
 Volvo C30 (09/06-12/13)  
 Volvo S40 II / V50 (12/03-12/12)

**Tie rod end****716 020 0019****MTE0514****Notes**

Front Axle Left  
 Front Axle Right

Length [mm] 74  
 Required quantity 2  
 Thread Size 1 M10x1,25  
 Thread Size 2 M14x2  
 replacement in pairs recommended

**References**

Ford 2T14-3289-AA

Ford 4 381 840

**Application info**

Ford Tourneo '02 (06/02-12/13)

Ford Transit '02 (06/02--)

**Tie rod end****716 020 0020****MTE0515****Notes**

Front Axle Left

Length [mm] 113  
 Paired article number 716 020 0021 | MTE0516  
 Required quantity 1  
 Thread Size 1 M14x2,0  
 Thread Size 2 M18x1,5  
 replacement in pairs recommended

**References**

Ford 1 433 274

Ford 6G91-3290-AA

Land Rover LR002610

Volvo 30776249

Volvo 31280000

Volvo 31302344

Volvo (Changan) 31302344

**Application info**

Ford Galaxy II (05/06-06/15)  
 Ford S-Max I (05/06-12/14)  
 Volvo S60 II / V60 (04/10--)  
 Volvo V70 III (04/07--)  
 Volvo XC70 II (04/07-12/16)

Ford Mondeo IV (03/07-01/15)  
 Land Rover Freelander II (10/06-12/15)  
 Volvo S80 II (03/06-12/16)  
 Volvo XC60 I (05/08-12/17)

**Tie rod end****716 020 0021****MTE0516****Notes**

Front Axle Right

Length [mm]

113

Paired article number

716 020 0020 | MTE0515

Required quantity

1

Thread Size 1

M14x2,0

Thread Size 2

M18x1,5

replacement in pairs recommended

**References**

Ford 1 433 273  
 Land Rover LR002609  
 Volvo 31280001  
 Volvo (Changan) 31302345

Ford 6G91-3289-AA  
 Volvo 30776248  
 Volvo 31302345

**Application info**

Ford Galaxy II (05/06-06/15)  
 Ford S-Max I (05/06-12/14)  
 Volvo S60 II / V60 (04/10--)  
 Volvo V70 III (04/07--)  
 Volvo XC70 II (04/07-12/16)

Ford Mondeo IV (03/07-01/15)  
 Land Rover Freelander II (10/06-12/15)  
 Volvo S80 II (03/06-12/16)  
 Volvo XC60 I (05/08-12/17)

**Tie rod end** **716 020 0022/HD** **MTE0517HD**

**Notes**

Carbon Neutral  
 Front Axle Left  
 Length [mm] 94  
 Paired article number 716 020 0023 | MTE0518  
 Paired article number 716 020 0023/HD | MTE0518HD  
 Required quantity 1  
 Thread Size 1 M12x1,75  
 Thread Size 2 M14x1,5  
 reinforced version  
 replacement in pairs recommended



**References**

Ford 1 545 339 Ford 2 248 199  
 Ford 8V51-3C437-AA Ford J7BC-3C437-AA

**Application info**

Ford B-MAX (08/12--) Ford Ecosport (09/11--)  
 Ford Fiesta VI (06/08--) Ford KA III (08/14--)  
 Ford Tourneo '14 (02/14--) Ford Transit Courier '14 (02/14--)

**Tie rod end** **716 020 0022** **MTE0517**

**Notes**

Front Axle Left  
 Length [mm] 94  
 Paired article number 716 020 0023 | MTE0518  
 Required quantity 1  
 Thread Size 1 M12x1,75  
 Thread Size 2 M14x1,5  
 replacement in pairs recommended







**References**



Ford 1 545 339 Ford 2 248 199  
 Ford 8V51-3C437-AA Ford J7BC-3C437-AA

**Application info**

Ford B-MAX (08/12--) Ford Ecosport (09/11--)  
 Ford Fiesta VI (06/08--) Ford KA III (08/14--)  
 Ford Tourneo '14 (02/14--) Ford Transit Courier '14 (02/14--)

Tie rod end		716 020 0023	MTE0518
<b>Notes</b>  Front Axle Right Length [mm] 94 Paired article number 716 020 0022   MTE0517 Paired article number 716 020 0022/HD   MTE0517HD Required quantity 1 Thread Size 1 M12x1,75 Thread Size 2 M14x1,5 replacement in pairs recommended			
<b>References</b> Ford 1 545 338 Ford 2 248 197 Ford 8V51-3C367-AA Ford J7BC-3C367-AA			
<b>Application info</b> Ford B-MAX (08/12--) Ford Ecosport (09/11--) Ford Fiesta VI (06/08--) Ford KA III (08/14--) Ford Tourneo '14 (02/14--) Ford Transit Courier '14 (02/14--)			
Tie rod end		716 020 0023/HD	MTE0518HD
<b>Notes</b>  Carbon Neutral Front Axle Right Length [mm] 94 Paired article number 716 020 0022/HD   MTE0517HD Required quantity 1 Thread Size 1 M12x1,75 Thread Size 2 M14x1,5 reinforced version replacement in pairs recommended			
<b>References</b> Ford 1 545 338 Ford 2 248 197 Ford 8V51-3C367-AA Ford J7BC-3C367-AA			
<b>Application info</b> Ford B-MAX (08/12--) Ford Ecosport (09/11--) Ford Fiesta VI (06/08--) Ford KA III (08/14--) Ford Tourneo '14 (02/14--) Ford Transit Courier '14 (02/14--)			

Tie rod end		716 020 0024	MTE0519
<b>Notes</b>  Front Axle Left Length [mm] 108 Paired article number 716 020 0025   MTE0520 Required quantity 1 Thread Size 1 M10x1,5 Thread Size 2 M16x1,5 replacement in pairs recommended			
<b>References</b> Ford 1 501 855 Ford 1 541 488 Ford 8V41-3290-AA Ford 8V41-3C437-AA			
<b>Application info</b> Ford Kuga I (02/08-11/12)			
Tie rod end		716 020 0025	MTE0520
<b>Notes</b>  Front Axle Right Length [mm] 108 Paired article number 716 020 0024   MTE0519 Required quantity 1 Thread Size 1 M10x1,5 Thread Size 2 M16x1,5 replacement in pairs recommended			
<b>References</b> Ford 1 501 853 Ford 1 541 485 Ford 8V41-3289-AA Ford 8V41-3C367-AA			
<b>Application info</b> Ford Kuga I (02/08-11/12)			

Tie rod end		716 020 0026	MTE0521
<b>Notes</b>  Front Axle Left Length [mm] 110 Paired article number 716 020 0027   MTE0522 Required quantity 1 Thread Size 1 M10x1,5 Thread Size 2 M16x1,5 replacement in pairs recommended			
<b>References</b> Ford 1 714 700 Ford 1 748 239 Ford 1 780 103 Ford 1 826 505 Ford AC6C-3C437-AA Ford AV6C-3C437-AA Ford BV6C-3C437-AA Ford BV6C-3C437-BA Ford BV6C-3C437-BB			
<b>Application info</b> Ford C-Max II (04/10--) Ford Focus III (07/10--) Ford Kuga II (05/12--) Ford Tourneo '13 (09/13--) Ford Transit '13 (02/13--)			
Tie rod end		716 020 0027	MTE0522
<b>Notes</b>  Front Axle Right Length [mm] 110 Paired article number 716 020 0026   MTE0521 Required quantity 1 Thread Size 1 M10x1,5 Thread Size 2 M16x1,5 replacement in pairs recommended			
<b>References</b> Ford 1 714 576 Ford 1 748 237 Ford 1 780 102 Ford 1 826 501 Ford AV6C-3C367-AA Ford BV6C-3C367-AA Ford BV6C-3C367-BA Ford BV6C-3C367-BB			

**Application info**

Ford C-Max II (04/10--)  
 Ford Kuga II (05/12--)  
 Ford Transit '13 (02/13--)

Ford Focus III (07/10--)  
 Ford Tourneo '13 (09/13--)

**Tie rod end**

716 020 0032/HD

MTE0854HD

**Notes**

Carbon Neutral  
 Front Axle Right  
 outer  
 Length [mm] 116  
 Paired article number 716 020 0033/HD | MTE0855HD  
 Required quantity 1  
 Thread Size 1 M14x2  
 Thread Size 2 M18x1,5  
 reinforced version  
 replacement in pairs recommended



**References**

Ford 1 802 974  
 Ford DG9C-3289-CA

Ford 5 333 720  
 Ford E1GC-3290-AA

**Application info**

Ford Galaxy III (01/15--)  
 Ford S-Max II (01/15--)

Ford Mondeo V (09/12--)

**Tie rod end**

716 020 0033/HD

MTE0855HD

**Notes**

Carbon Neutral  
 Front Axle Left  
 outer  
 Length [mm] 116  
 Paired article number 716 020 0032/HD | MTE0854HD  
 Required quantity 1  
 Thread Size 1 M14x2  
 Thread Size 2 M18x1,5  
 reinforced version  
 replacement in pairs recommended



**References**

Ford 1 802 977  
 Ford DG9C-3290-CA

Ford 5 333 724  
 Ford E1GC-3289-AA

**Application info**

Ford Galaxy III (01/15--)  
 Ford S-Max II (01/15--)

Ford Mondeo V (09/12--)

**Tie rod end**

716 020 0043/HD

MTE0918HD

**Notes**

Carbon Neutral  
 Front Axle Left  
 Length [mm] 119  
 Paired article number 716 020 0044/HD | MTE0920HD  
 Required quantity 1  
 Thread Size 1 12x1,75  
 Thread Size 2 14x1,5  
 reinforced version  
 replacement in pairs recommended



**References**

Ford 2 095 043

Ford KTH1BC3C437AA

**Application info**

Ford Ecosport (09/11--)

Ford Fiesta VII (05/17--)

**Tie rod end**

716 020 0044/HD

MTE0920HD

**Notes**

Carbon Neutral  
 Front Axle Right  
 Length [mm] 119  
 Paired article number 716 020 0043/HD | MTE0918HD  
 Required quantity 1  
 Thread Size 1 12x1,75  
 Thread Size 2 14x1,5  
 reinforced version  
 replacement in pairs recommended



**References**

Ford 2 090 579

Ford KTH1BC3C367AA

**Application info**

Ford Ecosport (09/11--)

Ford Fiesta VII (05/17--)



## Tie rod end

716 020 0045/HD

MTE0921HD

## Notes

Carbon Neutral

Front Axle Left

Length [mm]

116

Paired article number

716 020 0046/HD | MTE0922HD

Required quantity

1

Thread Size 1

M16x1,5

Thread Size 2

M10x1,5

reinforced version

replacement in pairs recommended



## References

Ford 2 194 040

Ford JX6C-3C437-AA

## Application info

Ford Focus IV (01/18--)

## Tie rod end

716 020 0046/HD

MTE0922HD

## Notes

Carbon Neutral

Front Axle Right

Length [mm]

116

Paired article number

716 020 0045/HD | MTE0921HD

Required quantity

1

Thread Size 1

M16x1,5

Thread Size 2

M10x1,5

reinforced version

replacement in pairs recommended





## References

Ford 2 194 042

Ford JX6C-3C367-AA

## Application info

Ford Focus IV (01/18--)

Tie rod end		716 020 0047	MTE0960
<b>Notes</b>  Front Axle Right outer Length [mm] 108 Paired article number 716 020 0048   MTE0961 Required quantity 1 Thread Size 1 M10x1,5 Thread Size 2 M16x1,5 replacement in pairs recommended			
<b>References</b> Ford 2 252 867		Ford KV6C-3C367-AA	
<b>Application info</b> Ford Tourneo '13 (09/13--))		Ford Transit '13 (02/13--))	
Tie rod end		716 020 0048	MTE0961
<b>Notes</b>  Front Axle Left outer Length [mm] 108 Paired article number 716 020 0047   MTE0960 Required quantity 1 Thread Size 1 M10x1,5 Thread Size 2 M16x1,5 replacement in pairs recommended			
<b>References</b> Ford 2 252 870		Ford KV6C-3C437-AA	
<b>Application info</b> Ford Tourneo '13 (09/13--))		Ford Transit '13 (02/13--))	

## Tie rod end

716 020 0049/HD

MTE0968HD

## Notes

Carbon Neutral  
Front Axle Left  
Front Axle Right

Length [mm] 90  
Required quantity 2  
Thread Size 1 M14X2,0  
Thread Size 2 M16X1,5  
reinforced version  
replacement in pairs recommended



## References

Ford 2 227 099  
Ford 2 550 678  
Ford KK26-3289-AA

Ford 2 360 730  
Ford KK21-3289-AA  
Ford KK26-3289-AB

## Application info

Ford Tourneo '12 (04/12--)  
Ford Transit Custom '12 (04/12--)

Ford Transit '14 (08/13--)

## Tie rod end

716 020 0050/HD

MTE0982HD

## Notes

Carbon Neutral  
Front Axle Right

Length [mm] 122  
Paired article number 716 020 0051/HD | MTE0983HD  
Required quantity 1  
Thread Size 1 M10x1,5  
Thread Size 2 M16x1,5  
reinforced version  
replacement in pairs recommended



## References

Ford 2 500 065  
Ford LX6C-3289-AB

Ford 2 513 826  
Ford LX6C-3C367-AA

## Application info

Ford Kuga III (07/19--)

## Tie rod end

716 020 0051/HD

MTE0983HD

## Notes

Carbon Neutral  
 Front Axle Left  
 Length [mm] 122  
 Paired article number 716 020 0050/HD | MTE0982HD  
 Required quantity 1  
 Thread Size 1 M10x1,5  
 Thread Size 2 M16x1,5  
 reinforced version  
 replacement in pairs recommended



## References

Ford 2 500 067  
 Ford LX6C-3290-AB

Ford 2 514 510  
 Ford LX6C-3C437-AA

## Application info

Ford Kuga III (07/19--)

## Tie rod end

716 020 0054/HD

MTE0996HD

## Notes

Front Axle Right  
 Length [mm] 122  
 Paired article number 716 020 0055/HD | MTE0997HD  
 Required quantity 1  
 Thread Size 1 M16x1,5  
 Thread Size 2 M14X2  
 reinforced version  
 replacement in pairs recommended





## References

Ford 2 486 867  
 Ford USA LJ9C3C367AA

Ford LJ9C-3C367-AA

## Application info

Ford USA Mustang Mach-E (CGW) (07/20--)

Tie rod end		716 020 0055/HD	MTE0997HD
<b>Notes</b>  Front Axle Left Length [mm] 122 Paired article number 716 020 0054/HD   MTE0996HD Required quantity 1 Thread Size 1 M16x1,5 Thread Size 2 M14X2 reinforced version replacement in pairs recommended			
<b>References</b> Ford 2 486 869 Ford LJ9C-3C437-AA Ford USA LJ9C3C437AA			
<b>Application info</b> Ford USA Mustang Mach-E (CGW) (07/20-- )			
Tie rod end		716 020 0331	MTE0523
<b>Notes</b>  Front Axle Left Front Axle Right Length [mm] 67 Required quantity 2 Thread Size 1 M10x1,25 Thread Size 2 1/2"-20 UNF replacement in pairs recommended			
<b>References</b> Ford 5 021 410 Ford 6 081 391 Ford 6 128 814 Ford 81AB-3289-AA Ford 84AB-3289-AA Ford 880X-3270-AA			
<b>Application info</b> Ford Escort III, IV / Orion I, II (09/80-10/94) Ford Fiesta I (05/76-11/86) Ford Fiesta II (03/83-12/95) Ford Fiesta III (01/89-01/97)			

**Tie rod end**

716 020 4100

MTE0527

**Notes**

Front Axle Right  
 Length [mm] 90  
 Paired article number 716 020 4101 | MTE0528  
 Required quantity 1  
 Thread Size 1 M16x1,5  
 Thread Size 2 M20x1,5  
 replacement in pairs recommended



**References**

Ford 5 021 446	Ford 6 163 543
Ford 6 792 900	Ford 880X-3270-SA
Ford 88VB-3285-AA	Ford 88VB-3285-AB
Ford 9 792 900	Mercedes-Benz 000 463 37 29
Mercedes-Benz 001 330 48 35	Mercedes-Benz 460 330 04 35
Mercedes-Benz 460 330 12 35	Mercedes-Benz 460 330 13 35
Mercedes-Benz 631 338 05 10	Mercedes-Benz A 000 463 37 29
Mercedes-Benz A 001 330 48 35	Mercedes-Benz A 460 330 04 35
Mercedes-Benz A 460 330 12 35	Mercedes-Benz A 460 330 13 35
Mercedes-Benz A 631 338 05 10	

**Application info**

Ford Transit '85 (09/85-12/00) Mercedes-Benz BM 631 (02/88-04/96)

**Tie rod end**

716 020 4101

MTE0528

**Notes**

Front Axle Left  
 with left-hand thread  
 Length [mm] 90  
 Paired article number 716 020 4100 | MTE0527  
 Required quantity 1  
 Thread Size 1 M16x1,5  
 Thread Size 2 M20x1,5  
 replacement in pairs recommended



**References**

Ford 5 021 447	Ford 6 163 544
Ford 6 792 901	Ford 880X-3270-TA
Ford 88VB-3286-AB	Ford 88VB-3286-AD
Mercedes-Benz 631 330 04 35	Mercedes-Benz A 631 330 04 35

**Application info**

Ford Transit '85 (09/85-12/00)

Mercedes-Benz BM 631 (02/88-04/96)

**Tie rod end**

716 020 4107

MTE0531

**Notes**

Front Axle Left  
Front Axle Right

Length [mm] 100  
Required quantity 2  
Thread Size 1 M16x1,5  
Thread Size 2 M16x1,5  
replacement in pairs recommended



**References**

Ford 1 039 103	Ford 1 047 145
Ford 6 517 364	Ford 6 687 191
Ford 92VB-3289-AA	Ford 92VX-3270-AA
Ford 97VB-3289-AA	Ford 97VX-3270-AA

**Application info**

Ford Transit '91 (01/91-09/94)

Ford Transit '94 (06/94-07/00)

**Tie rod end**

816 020 0001

MTE0536

**Notes**

Front Axle Right  
with right-hand thread

Length [mm] 136  
Paired article number 816 020 0020 | MTE0537  
Required quantity 1  
Thread Size 1 M12x1,5  
Thread Size 2 M14x1,5  
replacement in pairs recommended



**References**

Fiat 77363712	GENERAL MOTORS 93172255
Opel 16 03 228	Saab 12 78 7822
Saab 12 80 1424	Saab 12-76-5897
Saab 52 35 668	Saab 52 39 322
Saab 93 17 2255	Saab 93 19 4522
Saab 93-19-4329	Vauxhall 16 03 228

**Application info**

Fiat Cromo II (06/05--)

Saab 9-3 (YS3F) (09/02-02/15)

Saab 9-5 (YS3G) (01/10-01/12)

Opel Vectra C / Signum (04/02-01/09)

Saab 9-5 (YS3E) (09/97-12/09)

Vauxhall Vectra Mk II / Signum (01/00-05/09)

**Tie rod end****816 020 0020****MTE0537****Notes**Front Axle Left  
with right-hand thread

Length [mm]

136

Paired article number

816 020 0001 | MTE0536

Required quantity

1

Thread Size 1

M12x1,5

Thread Size 2

M14x1,5

replacement in pairs recommended

**References**

Fiat 77363713

Opel 16 03 227

Saab 12 80 1423

Saab 52 39 314

Saab 93 19 4521

Vauxhall 16 03 227

GENERAL MOTORS 93172254

Saab 12 78 7821

Saab 52 35 650

Saab 93 17 2254

Saab 93-19-4328

**Application info**

Fiat Cromo II (06/05--)

Saab 9-3 (YS3F) (09/02-02/15)

Saab 9-5 (YS3G) (01/10-01/12)

Opel Vectra C / Signum (04/02-01/09)

Saab 9-5 (YS3E) (09/97-12/09)

Vauxhall Vectra Mk II / Signum (01/00-05/09)

**Tie rod end****816 020 4904****MTE0539****Notes**Front Axle Left  
Front Axle Right  
for vehicles with power steering  
with right-hand thread

Length [mm]

125

Required quantity

2

Thread Size 1

M12x1,5

Thread Size 2

M14x1,5

replacement in pairs recommended





**DRIVER'S BEST FRIEND**

**MEYLE**

**References**

Saab 89 57 839

Saab 89 93 453

**Application info**

Saab 9000 (09/84-12/98)

## Suspension

## Axle support bushing

53-14 710 0001

MAB0216

## Notes

Lower  
Rear Axle Left  
Rear Axle Right

Height [mm] 65  
Inner Diameter [mm] 16  
Outer Diameter [mm] 54  
Required quantity 2  
replacement in pairs recommended



## References

Land Rover LR032644  
Land Rover RBK000041  
Land Rover RBK500012  
Land Rover RBK500220

Land Rover RBK000040  
Land Rover RBK000042  
Land Rover RBK500014

## Application info

Land Rover Discovery III (07/04-09/09)  
Land Rover Range Rover III (03/02-12/12)

Land Rover Discovery IV (09/09-12/18)  
Land Rover Range Rover Sport I (02/05-03/13)

## Axle support bushing

614 710 0004/HD

MAB0206HD

## Notes

Carbon Neutral  
Rear Axle Left  
Rear Axle Right

Height [mm] 90  
Inner Diameter [mm] 12  
Outer Diameter [mm] 68  
Replace in pairs only  
Required quantity 2  
reinforced version



## References

Chevrolet 13313230  
Opel 13313230  
Vauxhall 13313230

Chevrolet 4 02 041  
Opel 4 02 041  
Vauxhall 4 02 041

## Application info

Chevrolet Cruze (J300, J305) (07/00--)  
Vauxhall Astra Mk VI (12/09-10/15)

Opel Astra J (12/06--)

## Axle support bushing

70-14 710 0001

MAB0228

## Notes

Front  
Rear Axle Left  
Rear Axle Right  
Rubber-Metal Mount  
Upper  
for control arm  
for semi-trailing arm

Height [mm] 48  
Inner Diameter [mm] 12  
Outer Diameter [mm] 44  
Required quantity 1  
replacement in pairs recommended



## References

TESLA 1044411-00-F  
TESLA 1044416-00-F  
TESLA 1044427-00-C

TESLA 1044411-00-G  
TESLA 1044416-00-G  
TESLA 1188427-00-B

## Application info

TESLA Model 3 (01/17--)

TESLA Model Y (03/19--)

## Axle support bushing

714 710 0006

MAB0166

## Notes

Rear Axle Left  
Rear Axle Right

Height [mm] 78  
Inner Diameter [mm] 12  
Outer Diameter [mm] 70  
Required quantity 2  
replacement in pairs recommended



## References

Ford 1 535 296  
Ford 8V51-5K653-AA

Ford 1 805 815  
Ford 8V51-5K653-BA

## Application info

Ford Fiesta VI (06/08--)

**Ball joint****40-16 010 0002****MBJ0248****Notes**

Front Axle Left  
 Front Axle Right  
 Lower  
 with accessories

Cone Size [mm] 16  
 Required quantity 2  
 replacement in pairs recommended

**References**

Citroën 3640.39  
 Citroën 3640.43  
 Citroën 96 103 696  
 Peugeot 3640.42  
 Peugeot 96087507

Citroën 3640.42  
 Citroën 96 025 445  
 Peugeot 3640.38  
 Peugeot 3640.43

**Application info**

Citroën Berlingo I (07/96-12/11)  
 Citroën ZX (03/91-07/99)

Citroën Xsara (04/97-03/10)  
 Peugeot Partner I (05/96--)

**Ball joint****40-16 010 0004/HD****MBJ0249HD****Notes**

Carbon Neutral  
 Front Axle Left  
 Front Axle Right  
 Lower  
 with accessories

Required quantity 2  
 Thread Size M16x1,5  
 reinforced version  
 replacement in pairs recommended

**References**

Citroën 3640.55  
 Peugeot 3640.55

Fiat 1331640080

**Application info**

Citroën Jumper I (02/94-08/02)  
 Fiat Ducato (230) (03/94-05/05)  
 Peugeot Boxer I (03/94-08/05)

Citroën Jumper II (02/02--)  
 Fiat Ducato (244) (04/02--)  
 Peugeot Boxer II (12/01--)

**Ball joint** **416 010 0001** **MBJ0486**

**Notes**

Lower  
Rear Axle Left  
Rear Axle Right

Required quantity  
replacement in pairs recommended

2



**References**

Porsche 298 501 341  
Porsche 9J1 501 341

Porsche 970 331 244 00

**Application info**

Porsche Panamera (970) (03/09-12/17)

Porsche Panamera (971) (05/16--)

**Ball joint** **42-16 010 0010** **MBJ0252**

**Notes**

Front Axle Left  
Front Axle Right  
Lower

Length [mm]  
Required quantity  
Thread Size  
replacement in pairs recommended

51  
2  
M18x1,5



**References**

GENERAL MOTORS 94459465  
Isuzu 8944521021  
Isuzu 8944594652  
Isuzu 8980058750  
Isuzu 98005874  
Opel 03 52 828  
Vauxhall 03 52 828

Isuzu 8944521020  
Isuzu 8944594651  
Isuzu 8980058740  
Isuzu 94459465  
Isuzu 98005875  
Opel 3 52 828  
Vauxhall 3 52 828

**Application info**

Isuzu D-Max I (05/02-12/12)

Isuzu Trooper III (05/98-08/04)

Opel Frontera A / Monterey A (08/91-10/98)

Vauxhall Brava Pickup (12/88-12/02)

Vauxhall Frontera Mk II (10/98-10/04)

Vauxhall Monterey Mk II (07/98-08/99)

Isuzu Trooper II (Bighorn) (08/91-07/98)

Opel Campo (08/87-06/02)

Opel Frontera B / Monterey B (07/98-07/04)

Vauxhall Frontera Mk I (09/91-10/98)

Vauxhall Monterey Mk I (09/91-07/98)

**Ball joint**

44-16 010 0001

MBJ0253

**Notes**

Front Axle Left

Front Axle Right

Lower

Height [mm]

63

Required quantity

2

replacement in pairs recommended



**References**

Chrysler 04443405

Chrysler 04656010AE

Chrysler 4449553

Chrysler 4656010AE

Chrysler 04656010

Chrysler 4443405

Chrysler 4656010

Chrysler 4694747

**Application info**

Chrysler Neon (05/94-09/00)

Chrysler Voyager II (08/90-09/95)

Chrysler PT Cruiser (06/00-12/10)

Chrysler Voyager III/Caravan (01/95-12/01)

**Ball joint**

44-16 010 0004

MBJ0338

**Notes**

Front Axle Left

Front Axle Right

Outer Diameter [mm]

38

Required quantity

2

Thread Size

M12x1,25

replacement in pairs recommended



**References**

Chrysler 4766542AA

Chrysler 4766543AA

Chrysler 4766542AD

Chrysler 4766543AD

**Application info**

Chrysler Voyager IV/ Town Country (09/99-12/08)

**Ball joint****516 010 0002****MBJ0255****Notes**

Front Axle Left  
 Front Axle Right  
 Lower  
 with accessories

Cone Size [mm]

12.7

Required quantity

2

Thread Size

M12x1,75

replacement in pairs recommended

**References**

Volvo 274185

Volvo 274524

Volvo 274548

Volvo 8634438

Volvo 91736132

Volvo 274193

Volvo 274544

Volvo 274593

Volvo 9173613

Volvo 9492639

**Application info**

Volvo S60 I / V70 II (11/99-04/10)

Volvo XC70 I (10/97-10/07)

Volvo S80 I (05/98-02/08)

**Ball joint****516 010 0003/HD****MBJ0256HD****Notes**

Carbon Neutral  
 Front Axle Left  
 Front Axle Right  
 Lower  
 with accessories

Required quantity

2

Thread Size

M14x2,0

reinforced version

replacement in pairs recommended



**References**

Volvo 274377

Volvo 274573

Volvo 274523

Volvo 31201485

**Application info**

Volvo S60 I / V70 II (11/99-04/10)

Volvo XC90 I (06/02-01/15)

Volvo XC70 I (10/97-10/07)

**Ball joint**

516 010 0005

MBJ0257

**Notes**

Front Axle Left

Front Axle Right

with accessories

2

Required quantity

replacement in pairs recommended

**References**

Volvo 31277525

Volvo 31317665

Volvo 31277526

Volvo 31317666

**Application info**

Volvo S60 II / V60 (04/10--)

Volvo XC70 II (04/07-12/16)

Volvo XC60 I (05/08-12/17)

**Ball joint**

516 010 0006

MBJ0342

**Notes**

Front Axle Left

Front Axle Right

Lower

with retaining ring

Height [mm]

49

Outer Diameter [mm]

40

Required quantity

2

Thread Size

M12x1,25

replacement in pairs recommended





**References**

- |                     |                     |
|---------------------|---------------------|
| Mitsubishi AW311699 | Mitsubishi MN133617 |
| Mitsubishi MN133618 | Mitsubishi MR179479 |
| Mitsubishi MR179480 | Volvo 30821650      |
| Volvo 30821651      | Volvo 30863988      |
| Volvo 30863989      | Volvo 30887025      |
| Volvo 30887033      | Volvo 3088746       |
| Volvo 3088747       | Volvo 30887653      |
| Volvo 30887654      | Volvo 3088896       |
| Volvo 30888962      | Volvo 30889962      |
| Volvo 30889963      |                     |

**Application info**

- |                                  |                            |
|----------------------------------|----------------------------|
| Mitsubishi Carisma (07/95-06/06) | Volvo S/V 40 (07/95-12/04) |
| Volvo S40 II / V50 (12/03-12/12) |                            |

**Ball joint**

516 010 0007

MBJ0440

**Notes**

Front Axle Left  
 Lower  
 outer  
 with attachment material  
 Paired article number 516 010 0008 | MBJ0441  
 Required quantity 1

replacement in pairs recommended



**References**

- Volvo 31340232

**Application info**

- Volvo V40 II (03/12--)

**Ball joint**

516 010 0008

MBJ0441

**Notes**

Front Axle Right  
 Lower  
 outer  
 with attachment material  
 Paired article number 516 010 0007 | MBJ0440  
 Required quantity 1  
 replacement in pairs recommended

**References**

Volvo 31340231

**Application info**

Volvo V40 II (03/12--)

**Ball joint**

516 010 3284

MBJ0259

**Notes**

Front Axle Left  
 Front Axle Right  
 Lower  
 with accessories  
 Length [mm] 37.5  
 Required quantity 2  
 Thread Size M12x1,75  
 replacement in pairs recommended

**References**

Volvo 1270477

Volvo 1273819

Volvo 1359590

Volvo 270477

Volvo 2704773

**Application info**

Volvo 740 / 760 / 780 (08/81-12/92)

Volvo 940 / 960 (08/90-10/95)

Volvo 940 / 960 / S/V 90 (09/90-12/98)



**Ball joint**

516 010 5554

MBJ0262

**Notes**

Front Axle Left  
 Front Axle Right  
 Lower  
 with accessories

Cone Size [mm]

19

Length [mm]

38

Required quantity

2

replacement in pairs recommended

**References**

Volvo 271591

Volvo 3546524

**Application info**

Volvo 850 (06/91-10/97)

**Ball joint**

53-16 010 0000

MBJ0264

**Notes**

Front Axle Left  
 Front Axle Right  
 Upper

Height [mm]

95

Outer Diameter [mm]

42

Required quantity

2

Thread Size

M12x1,75

replacement in pairs recommended

**References**

Land Rover RBJ500221

Land Rover RBJ500222

Land Rover RBJ500231

Land Rover RBJ500232

Land Rover RBK500030

**Application info**

Land Rover Discovery III (07/04-09/09)

**Ball joint**

53-16 010 0001

MBJ0265

**Notes**

Front Axle Left  
Front Axle Right

Lower

Outer Diameter [mm]

45

Required quantity

2

Thread Size

M12x2,0

replacement in pairs recommended

**References**

Land Rover RBK500040

Land Rover RBK500180

Land Rover RBK500230

Land Rover RBK500240

Land Rover RBK500280

Land Rover RBK500300

**Application info**

Land Rover Discovery III (07/04-09/09)

Land Rover Discovery IV (09/09-12/18)

Land Rover Range Rover Sport I (02/05-03/13)

**Ball joint**

53-16 010 0003

MBJ0463

**Notes**

Front Axle Left  
Front Axle Right

Upper

Required quantity

2

Thread Size

M14x1,5

replacement in pairs recommended





**References**

Land Rover FTC3570

**Application info**

Land Rover Discovery II (10/98-08/04)

Land Rover Range Rover II (07/94-03/02)

Ball joint		53-16 010 0004	MBJ0266
<b>Notes</b>  Front Axle Left Front Axle Right Upper Height [mm] 103 Outer Diameter [mm] 42 Required quantity 2 Thread Size M12x1,75 replacement in pairs recommended		 	
<b>References</b> Land Rover RBK500161		Land Rover RBK500170	
<b>Application info</b> Land Rover Discovery III (07/04-09/09) Land Rover Range Rover Sport I (02/05-03/13)		Land Rover Discovery IV (09/09-12/18)	
Ball joint		53-16 010 0005	MBJ0267
<b>Notes</b>  Front Axle Left Front Axle Right Lower Required quantity 2 Thread Size M16x1,5 replacement in pairs recommended		 	
<b>References</b> Land Rover FTC3571			
<b>Application info</b> Land Rover Discovery II (10/98-08/04)		Land Rover Range Rover II (07/94-03/02)	

**Ball joint**

53-16 010 0011/HD

MBJ0448HD

**Notes**

Carbon Neutral  
Front Axle Left  
Front Axle Right  
Upper

with accessories

2

53-16 050 0027/HD

53-16 050 0028/HD

Required quantity

only in connection with

only in connection with

reinforced version

replacement in pairs recommended



**References**

Land Rover LR034211  
Land Rover LR034213  
Land Rover LR034215  
Land Rover LR044841  
Land Rover LR044843  
Land Rover LR044845  
Land Rover LR044845  
Land Rover LR108765  
Land Rover LR113259  
Land Rover LR113261  
Land Rover LR113263  
Land Rover LR113265  
Land Rover LR113267  
Land Rover LR113270  
Land Rover LR125697  
Land Rover LR125701  
Land Rover LR125711  
Land Rover LR125713  
Land Rover LR139239  
Land Rover LR148192

Land Rover LR034212  
Land Rover LR034214  
Land Rover LR034216  
Land Rover LR044842  
Land Rover LR044844  
Land Rover LR044846  
Land Rover LR108766  
Land Rover LR113260  
Land Rover LR113262  
Land Rover LR113264  
Land Rover LR113266  
Land Rover LR113268  
Land Rover LR113271  
Land Rover LR125698  
Land Rover LR125702  
Land Rover LR125712  
Land Rover LR125714  
Land Rover LR139240  
Land Rover LR148193

**Application info**

Land Rover Discovery V (09/16--)

Land Rover Range Rover Sport II (04/13--)

Land Rover Range Rover IV (08/12--)

**Ball joint**

53-16 010 0014

MBJ0507

**Notes**

Front Axle Left  
Front Axle Right  
for control arm

Required quantity  
replacement in pairs recommended

2



**References**

- |                        |                        |
|------------------------|------------------------|
| Jaguar J9C13931        | Jaguar J9C13932        |
| Jaguar J9C19214        | Jaguar J9C19215        |
| Jaguar J9C2115         | Jaguar J9C2117         |
| Jaguar J9C33A052AB     | Jaguar J9C33A052AC     |
| Jaguar J9C33A052AD     | Jaguar J9C33A052AE     |
| Jaguar J9C33A053AC     | Jaguar J9C33A053AD     |
| Jaguar J9C33A053AE     | Land Rover FK723A052AD |
| Land Rover FK723A052AE | Land Rover FK723A052AF |
| Land Rover FK723A052AJ | Land Rover FK723A052AK |
| Land Rover FK723A053AD | Land Rover FK723A053AE |
| Land Rover FK723A053AF | Land Rover FK723A053AH |
| Land Rover FK723A053AJ | Land Rover FK723A053AK |
| Land Rover J9C33A052AB | Land Rover J9C33A052AC |
| Land Rover J9C33A052AD | Land Rover J9C33A052AE |
| Land Rover J9C33A053AB | Land Rover J9C33A053AC |
| Land Rover J9C33A053AD | Land Rover J9C33A053AE |
| Land Rover LR060046    | Land Rover LR060047    |
| Land Rover LR086107    | Land Rover LR086108    |
| Land Rover LR096362    | Land Rover LR096363    |
| Land Rover LR101811    | Land Rover LR101812    |
| Land Rover LR104884    | Land Rover LR104885    |
| Land Rover LR110277    | Land Rover LR110278    |
| Land Rover LR110312    | Land Rover LR110313    |
| Land Rover LR115121    | Land Rover LR115123    |
| Land Rover LR117140    | Land Rover LR117141    |
| Land Rover LR126118    | Land Rover LR126119    |

**Application info**

- |   |                                      |
|---|--------------------------------------|
| Jaguar E-Pace (X540) (09/17--)                | Land Rover Discovery Sport (09/14--) |
| Land Rover Range Rover Evoque I (06/11-12/19) |                                      |



**Ball joint** **57-16 010 0002** **MBJ0454**

**Notes**

Front Axle Left  
 Front Axle Right  
 Lower

Required quantity 2  
 replacement in pairs recommended



**References**

Dodge 5135651AC  
 Dodge 5135651AE  
 Jeep 5135651AD  
 Jeep 52089980AD  
 Jeep 52089980AG  
 Jeep 52089981AD  
 Jeep 52089981AG

Dodge 5135651AD  
 Jeep 5135651AC  
 Jeep 5135651AE  
 Jeep 52089980AF  
 Jeep 52089980AI  
 Jeep 52089981AF  
 Jeep 52089981AI

**Application info**

Dodge Nitro (09/06-12/12)  
 Jeep Grand Cherokee (WH) (10/04-10/11)

Jeep Commander (XK) (09/05-12/10)

**Ball joint** **616 010 0001** **MBJ0268**

**Notes**

Front Axle Left  
 Front Axle Right  
 Lower  
 with accessories

Length [mm] 26  
 Required quantity 2  
 replacement in pairs recommended



**References**

GENERAL MOTORS 9196394  
 Opel 3 52 803  
 Vauxhall 3 52 803

Opel 03 52 803  
 Vauxhall 03 52 803

**Application info**

Opel Corsa C / Combo / Tigra (09/00--)

Vauxhall Combo Mk II (09/01-02/12)

Vauxhall Corsa Mk II / Tigra / Combo (08/00-02/12)

**Ball joint**

616 010 0003

MBJ0269

**Notes**

Front Axle Right

Lower

with accessories

Paired article number

616 010 0004 | MBJ0270

Required quantity

1

replacement in pairs recommended



**References**

GENERAL MOTORS 93174599

GENERAL MOTORS 93190906

Opel 03 52 086

Opel 3 52 086

Opel 53 52 026

Vauxhall 3 52 086

Vauxhall 53 52 026

**Application info**

Opel Meriva A (05/03-05/10)

Vauxhall Meriva Mk I A (01/03-06/10)

**Ball joint**

616 010 0004

MBJ0270

**Notes**

Front Axle Left

Lower

with accessories

Paired article number

616 010 0003 | MBJ0269

Required quantity

1

replacement in pairs recommended



**References**

GENERAL MOTORS 93174598

GENERAL MOTORS 93190905

Opel 03 52 085

Opel 3 52 085

Opel 53 52 025

Vauxhall 3 52 085

Vauxhall 53 52 025

**Application info**

Opel Meriva A (05/03-05/10)

Vauxhall Meriva Mk I A (01/03-06/10)

**Ball joint****616 010 0005/HD****MBJ0271HD****Notes**

Carbon Neutral  
 Front Axle Left  
 Front Axle Right  
 Upper

Outer Diameter [mm]

45

Required quantity

2

Thread Size

M14x1,5

reinforced version

replacement in pairs recommended

**References**

GENERAL MOTORS 9160554

Nissan 40160-00QAB

Opel 45 00 254

Renault 7700312851

Vauxhall 45 00 254

**Application info**

Nissan Interstar I (X70) (04/02--)

Opel Movano A (07/98--)

Renault Master II (03/98--)

Vauxhall Movano Mk I (10/98-12/10)

**Ball joint****616 010 0006****MBJ0272****Notes**

Front Axle Left  
 Front Axle Right  
 Lower  
 with accessories

Length [mm]

39

Required quantity

2

replacement in pairs recommended



**References**

Alfa Romeo 50511650  
 Alfa Romeo 51783056  
 Alfa Romeo 51892273  
 Alfa Romeo 51895367  
 Alfa Romeo 55703629  
 Citroën 3520.W3  
 Citroën 3521.S6  
 Fiat 51783057  
 Fiat 51839040  
 Fiat 51874462  
 Fiat 51892273  
 Fiat 51895367  
 GENERAL MOTORS 93190907  
 Opel 03 52 087  
 Opel 3 52 087  
 Peugeot 3520.W3  
 Peugeot 3521.S6  
 Vauxhall 03 52 087  
 Vauxhall 3 52 087

Alfa Romeo 50521486  
 Alfa Romeo 51892272  
 Alfa Romeo 51895366  
 Alfa Romeo 55703627  
 Citroën 3520 Y4  
 Citroën 3521 V5  
 Fiat 51783056  
 Fiat 51839039  
 Fiat 51874461  
 Fiat 51892272  
 Fiat 51895366  
 GENERAL MOTORS 93188808  
 Opel 03 52 067  
 Opel 3 52 067  
 Peugeot 3520 Y4  
 Peugeot 3521 V5  
 Vauxhall 03 52 067  
 Vauxhall 3 52 067

**Application info**

ABARTH Grande Punto (12/07-12/12)  
 Alfa Romeo Mito (08/08--)  
 Fiat Grande Punto (06/05--)  
 Fiat Punto Evo (07/08--)  
 Fiat Qubo (02/08--)  
 Opel Corsa D (07/06-08/14)  
 Peugeot Bipper (02/08--)  
 Vauxhall Combo Mk III (07/06--)  
 Vauxhall Corsa Mk IV (08/14--)

ABARTH Punto III (03/12--)  
 Citroën Nemo (02/08--)  
 Fiat Linea (10/06--)  
 Fiat Punto III (01/12--)  
 Opel Adam (10/12-02/19)  
 Opel Corsa E (09/14--)  
 Vauxhall Adam (10/12-04/19)  
 Vauxhall Corsa Mk III (07/06-08/14)

**Ball joint****616 010 0007****MBJ0273****Notes**

Front Axle Left  
 Front Axle Right  
 Upper  
 with accessories

Required quantity 2  
 Thread Size M14x1,5  
 replacement in pairs recommended



**References**

GENERAL MOTORS 94374424  
 Isuzu 8980058260  
 Opel 03 10 823  
 Vauxhall 03 10 823

Isuzu 8943744240  
 Isuzu 98005826  
 Opel 3 10 823  
 Vauxhall 3 10 823

**Application info**

Isuzu Trooper II (Bighorn) (08/91-07/98)  
 Opel Frontera A / Monterey A (08/91-10/98)  
 Vauxhall Frontera Mk I (09/91-10/98)  
 Vauxhall Monterey Mk I (09/91-07/98)

Isuzu Trooper III (05/98-08/04)  
 Opel Frontera B / Monterey B (07/98-07/04)  
 Vauxhall Frontera Mk II (10/98-10/04)  
 Vauxhall Monterey Mk II (07/98-08/99)

**Ball joint**

616 010 0008

MBJ0274

**Notes**

Front Axle Left  
 Front Axle Right  
 with accessories

Required quantity 2  
 Thread Size M12x1,5  
 replacement in pairs recommended



**References**

Chevrolet 25995128  
 Chevrolet 96626236  
 Chevrolet 96819161  
 Chevrolet 96852964  
 GENERAL MOTORS 20946158  
 GENERAL MOTORS 25995129  
 GENERAL MOTORS 96626236  
 GENERAL MOTORS 96819162  
 Opel 48 02 540  
 Opel 48 06 300  
 Opel 48 10 831  
 Opel 48 17 777  
 Vauxhall 48 02 540  
 Vauxhall 48 06 300  
 Vauxhall 48 10 831  
 Vauxhall 48 17 778

Chevrolet 96626235  
 Chevrolet 96810754  
 Chevrolet 96819162  
 GENERAL MOTORS 20946157  
 GENERAL MOTORS 25995128  
 GENERAL MOTORS 96626235  
 GENERAL MOTORS 96819161  
 Opel 47 17 777  
 Opel 48 02 541  
 Opel 48 06 301  
 Opel 48 12 870  
 Opel 48 17 778  
 Vauxhall 48 02 541  
 Vauxhall 48 06 301  
 Vauxhall 48 12 870

**Application info**

Chevrolet Captiva I (06/06--)  
 Vauxhall Antara (08/06--)

Opel Antara (05/06--)

**Ball joint**

616 010 0009

MBJ0275

**Notes**

Required quantity  
 replacement in pairs recommended

Front Axle Left  
 Front Axle Right  
 with accessories  
 2



**References**

Chevrolet 95017034  
 Chevrolet 95916024  
 GENERAL MOTORS 95916024  
 Opel 3 52 532

Chevrolet 95907943  
 Chevrolet 95952907  
 Opel 03 52 532  
 Vauxhall 3 52 532

**Application info**

Chevrolet Aveo II (03/11--)  
 Opel Mokka A (06/12--)

Chevrolet Trax (12/12--)  
 Vauxhall Mokka A (06/12--)

**Ball joint**

616 010 0013

MBJ0462

**Notes**

Required quantity  
 replacement in pairs recommended

Front Axle Left  
 Front Axle Right  
 Upper  
 2



**References**

GENERAL MOTORS 13258056  
 Vauxhall 3 24 000

Opel 3 24 000

**Application info**

Opel Astra J (12/06--)  
 Opel Insignia A (07/08-03/17)  
 Vauxhall Cascada (02/13--)

Opel Cascada (03/13-04/19)  
 Vauxhall Astra Mk VI (12/09-10/15)  
 Vauxhall Insignia Mk I A (07/08-05/17)

**Ball joint**

616 010 0015

MBJ0465

**Notes**

Front Axle Left  
 Front Axle Right  
 outer

Required quantity 2  
 Thread Size M14x1,5  
 replacement in pairs recommended



**References**

Citroën 98 034 340 80  
 Opel 36 37 430  
 Vauxhall 3637430

GENERAL MOTORS 3637430  
 Peugeot 98 03 434 080

**Application info**

Citroën C4 Grand Picasso II (01/13--)  
 Citroën C4 SPACETOURER / GRAND SPACETOURER  
 (04/18--)

Opel Grandland X (75) (06/17--)  
 Peugeot 5008 II (12/16--)  
 Vauxhall Grandland X (75) (06/17--)

Citroën C4 II / DS4 (02/09--)  
 Citroën C5 AIRCROSS (11/18--)

Peugeot 3008 II (05/16--)  
 Peugeot 508 II (09/18--)

**Ball joint**

616 010 0016/HD

MBJ0476HD

**Notes**

Carbon Neutral  
 Front Axle Left  
 Front Axle Right  
 for control arm

Required quantity 2  
 Thread Size M12x1,75  
 reinforced version  
 replacement in pairs recommended



**References**

GENERAL MOTORS 39021472  
 GENERAL MOTORS 39089344  
 Opel 39021472  
 Opel 39089344  
 Vauxhall 39 08 9345  
 Vauxhall 39021473

GENERAL MOTORS 39021473  
 GENERAL MOTORS 39089345  
 Opel 39021473  
 Opel 39089345  
 Vauxhall 39021472  
 Vauxhall 39089344

**Application info**

Opel Astra K (06/15--)

Vauxhall Astra Mk VII (07/15--)

**Ball joint**

616 010 0017

MBJ0472

**Notes**

Front Axle Left  
 Front Axle Right  
 Lower  
 outer  
 2

Required quantity  
 replacement in pairs recommended



**References**

Fiat 6000618835  
 Nissan 54500-00Q2B  
 Renault 545006069R

GENERAL MOTORS 93868599  
 Opel 44 22 269  
 Vauxhall 44 22 269

**Application info**

Fiat Talento (06/16--)  
 Nissan Primastar II (X82) (11/21--)  
 Renault Trafic III (05/14--)

Nissan NV300 (09/16--)  
 Opel Vivaro B (06/14--)  
 Vauxhall Vivaro B (05/14--)

**Ball joint**

616 010 5382

MBJ0278

**Notes**

Front Axle Left  
 Front Axle Right  
 with accessories  
 34  
 2  
 M12x1,5

Length [mm]  
 Required quantity  
 Thread Size  
 replacement in pairs recommended





**References**

GENERAL MOTORS 90295479  
 GENERAL MOTORS 90444858  
 Opel 16 03 163  
 Opel 16 03 190  
 Vauxhall 16 03 163

GENERAL MOTORS 90297863  
 Opel 16 03 121  
 Opel 16 03 167  
 Vauxhall 16 03 121  
 Vauxhall 16 03 167

**Application info**

Opel Ascona C (09/81-10/88)  
 Opel Calibra (08/89-07/97)  
 Vauxhall Astra Mk III (01/91-03/01)  
 Vauxhall Cavalier Mk III (08/88-11/95)

Opel Astra F (09/91-01/05)  
 Opel Vectra A (04/88-12/95)  
 Vauxhall Calibra Mk I (06/90-07/97)

**Ball joint****616 010 5583****MBJ0282****Notes**

Front Axle Left  
 Front Axle Right  
 Lower  
 with accessories  
 77  
 2

Length [mm]

Required quantity

replacement in pairs recommended

**References**



Chevrolet 90487561  
 Chevrolet 90542995  
 GENERAL MOTORS 90512982  
 Opel 3 52 800  
 Opel 3 52 830  
 Saab 52 31 683  
 Vauxhall 3 52 800  
 Vauxhall 3 52 830



Chevrolet 90512982  
 GENERAL MOTORS 90487561  
 GENERAL MOTORS 90542995  
 Opel 3 52 829  
 Saab 48 35 740  
 Saab 93-18-5278  
 Vauxhall 3 52 829

**Application info**

Chevrolet Zafira (F75) (02/99-12/12)  
 Opel Astra H / Zafira B (01/04-05/19)  
 Opel Meriva B (06/10-03/17)  
 Opel Vectra B (09/95-07/04)  
 Vauxhall Astra Mk IV (01/93-08/06)  
 Vauxhall Insignia Mk I A (07/08-05/17)  
 Vauxhall Omega Mk II (12/93-07/03)  
 Vauxhall Zafira Mk I (11/98-08/05)

Opel Astra G / Astra Classic / Zafira A (02/98-12/09)  
 Opel Astra J (12/06--)  
 Opel Omega B (03/94-12/05)  
 Saab 9-5 (YS3E) (09/97-12/09)  
 Vauxhall Astra Mk V (01/04--)  
 Vauxhall Meriva Mk II B (06/10--)  
 Vauxhall Vectra Mk I (08/95-07/03)  
 Vauxhall Zafira Mk II (04/05-11/14)

Ball joint		616 010 6005	MBJ0283
<b>Notes</b>  Front Axle Left Front Axle Right Lower with accessories  Length [mm] 64 Required quantity 2 replacement in pairs recommended			
<b>References</b> GENERAL MOTORS 90542574 Opel 17 73 902 Vauxhall 17 73 902		Opel 16 03 202 Vauxhall 16 03 202	
<b>Application info</b> Opel Corsa B / Combo / Tigra (03/93-12/02) Vauxhall Corsa Mk I Tigra (12/92-12/00)		Vauxhall Combo Mk I (07/94-10/01)	
Ball joint		716 010 0001	MBJ0284
<b>Notes</b>  Front Axle Left Front Axle Right Lower with accessories  Length [mm] 37 Required quantity 2 replacement in pairs recommended			
<b>References</b> Ford 1 047 853 Ford 6 732 631		Ford 1 522 781 Ford 89FB-3395-AB	
<b>Application info</b> Ford Escort V, VI, VII / Orion III (01/90-10/02)		Ford Fiesta III (01/89-01/97)	

Ball joint		716 010 0004	MBJ0285
<p><b>Notes</b></p> <p>Front Axle Left Front Axle Right Lower with accessories</p> <p>Length [mm] 56 Required quantity 2 Thread Size M18x1,5 replacement in pairs recommended</p>			
<p><b>References</b></p> <p>Ford 5 021 430 Ford 6 154 162 Ford 86VB-3395A-2B Ford 880X-3K209-GA</p>			
<p><b>Application info</b></p> <p>Ford Transit '77 (01/77-10/86) Ford Transit '85 (09/85-12/00)</p>			
Ball joint		716 010 0005	MBJ0286
<p><b>Notes</b></p> <p>Front Axle Left Front Axle Right Lower with accessories</p> <p>Length [mm] 55 Required quantity 2 Thread Size M20x1,5 replacement in pairs recommended</p>			
<p><b>References</b></p> <p>Ford 1 055 194 Ford 5 025 676 Ford 6 650 261 Ford 6 924 365 Ford 92VB-3395-A2C Ford 92VB-3395-A2D Ford 92VX-3K209-AA Ford 97VX-3K209-AA</p>			
<p><b>Application info</b></p> <p>Ford Transit '91 (01/91-09/94) Ford Transit '94 (06/94-07/00)</p>			

**Ball joint****716 010 0006****MBJ0287****Notes**

Front Axle Left  
 Front Axle Right  
 Lower  
 with accessories

Length [mm]

37

Required quantity

2

replacement in pairs recommended

**References**

Ford 1 030 025

Ford 1 047 797

Ford 1 679 398

Ford 94FB-3395A-2B

Ford 94FB-3B376-AA

Ford 94FB-3B376-AB

Ford 94FB-3B378-AA

Ford ME96FB3395AA

Mazda 1E00-34-550

**Application info**

Ford Fiesta III (01/89-01/97)

Ford Fiesta IV / Puma (08/95--)

Ford KA I (09/96-11/08)

Mazda 121 (JASM, JBSM) (01/96-04/03)

**Ball joint****716 010 0009****MBJ0288****Notes**

Front Axle Left  
 Front Axle Right  
 Lower  
 with accessories

Length [mm]

38

Required quantity

2

replacement in pairs recommended

**References**

Ford 1 138 160

Ford 1 148 931

Ford 1 207 973

Ford 1 679 401

Ford 98AG-3395-AE

Ford ME98AG3395AA

**Application info**

Ford Focus I (08/98-11/09)

**Ball joint****716 010 0012/HD****MBJ0289HD****Notes**

Carbon Neutral  
 Front Axle Left  
 Front Axle Right  
 Lower  
 with accessories

Height [mm] 93  
 Outer Diameter [mm] 44.4  
 Required quantity 2  
 Thread Size M16x1,5  
 reinforced version  
 replacement in pairs recommended

**References**

Ford 1 417 352	Ford 1 451 914
Ford 1 743 281	Ford 1 763 713
Ford 1 817 752	Ford 2 115 116
Ford 2 207 758	Ford 2 207 780
Ford 2 315 613	Ford 4 041 454
Ford 4 120 734	Ford 4 173 761
Ford 4 381 927	Ford 4 386 870
Ford 4 616 978	Ford 4 630 551
Ford KK21-3395-AA	Ford KK21-3395-AB
Ford KT2T14-3468-AA	Ford KT6C11-3K209-BA
Ford KTBK21-3K209-AA	Ford KTBK21-3K209-AB
Ford KTBK21-3K209-AC	Ford KTKK21-3K209-AA
Ford KTYC15-3468-AA	Ford KTYC15-3468-AC
Ford KTYC15-3468-AD	Ford KTYC15-3468-AE
Ford KTYC15-3468-AF	Ford YC1A-3395-BA
Ford YC1A-3395-CA	Ford YC1A-3395-CB

**Application info**

Ford Tourneo '02 (06/02-12/13)	Ford Tourneo '12 (04/12--)
Ford Transit '02 (06/02--)	Ford Transit '06 (04/06-12/14)
Ford Transit '14 (08/13--)	Ford Transit Custom '12 (04/12--)

**Ball joint**

716 010 0013

MBJ0290

**Notes**

Front Axle Left  
 Front Axle Right  
 Lower  
 with accessories

Required quantity  
 replacement in pairs recommended

2



**References**

- |                   |                     |
|-------------------|---------------------|
| Ford 1 146 130    | Ford 1 146 131      |
| Ford 1 207 447    | Ford 1 207 448      |
| Ford 1 211 757    | Ford 1 212 807      |
| Ford 1 212 808    | Ford 1 214 911      |
| Ford 1 214 912    | Ford 1 436 095      |
| Ford 1 436 097    | Ford 1 436 169      |
| Ford 1 436 170    | Ford 1 679 382      |
| Ford 1 706 970    | Ford 1 706 971      |
| Ford 2N11-3042-AE | Ford 2N11-3042-AH   |
| Ford 2N11-3051-AE | Ford 2N11-3051-AG   |
| Ford 2N11-3051-AH | Ford 2S61-3042-AD   |
| Ford 2S61-3042-AH | Ford 2S61-3042-AJ   |
| Ford 2S61-3042-AK | Ford 2S61-3042-DA   |
| Ford 2S61-3051-AD | Ford 2S61-3051-AH   |
| Ford 2S61-3051-AJ | Ford 2S61-3051-AK   |
| Ford 2S61-3051-DA | Ford ME2S6J-3395-AA |
| Mazda DD32-34-300 | Mazda DD32-34-350   |

**Application info**

Ford Fiesta V / Fusion (11/01-12/14)

Mazda 2 (DY) (02/03-06/07)

**Ball joint**

716 010 0014

MBJ0291

**Notes**

Front Axle Left  
 Front Axle Right  
 Lower  
 with accessories

Cone Size [mm]

18

Length [mm]

83

Required quantity

2

Thread Size

M14x1,5

replacement in pairs recommended

**References**The references of this product can be found at [www.meyle.com](http://www.meyle.com)**Application info**

Ford Focus II (10/03--)

Volvo C70 II (03/06-12/13)

Volvo C30 (09/06-12/13)

Volvo S40 II / V50 (12/03-12/12)

**Ball joint**

716 010 0017

MBJ0293

**Notes**

Front Axle Left  
 Front Axle Right  
 Lower  
 with accessories

Cone Size [mm]

21

Required quantity

2

Thread Size

M14x1,5

replacement in pairs recommended

**References**

Ford 1 470 387

Ford 3M51-3K209-BA

Volvo 31201181

Ford 1 679 388

Volvo 31201180

**Application info**

Ford C-Max I (02/07-09/10)

Volvo C30 (09/06-12/13)

Volvo S40 II / V50 (12/03-12/12)

Ford Focus II (10/03--)

Volvo C70 II (03/06-12/13)

**Ball joint****716 010 0018****MBJ0294****Notes**

Front Axle Left  
 Front Axle Right  
 with accessories

Required quantity

2

Thread Size

M14x1,5

replacement in pairs recommended

**References**

Ford 1 377 846

Ford 1 385 593

Ford 1 403 408

Ford 1 419 814

Ford 1 426 875

Ford 1 435 745

Ford 1 458 773

Ford 1 460 693

Ford 1 466 186

Ford 1 466 188

Ford 1 469 024

Ford 1 507 181

Ford 1 507 182

Ford 6G9N-3A052-DA

Ford 6G9N-3A052-DB

Ford 6G9N-3A052-DC

Ford 6G9N-3A052-DD

Ford 6G9N-3A052-DE

Ford 6G9N-3A052-DF

Ford 6G9N-3A052-DG

Ford 6G9N-3A052-DH

Ford 6G9N-3A053-DG

Ford 6G9N-3A053-DH

Ford 7G9N-3A052-BA

Ford 7G9N-3A052-BB

Ford 7G9N-3A053-BA

Ford 7G9N-3A053-BB

Ford (Chanagan) 7G9N-3A052-BA

Ford (Chanagan) 7G9N-3A052-BB

Ford (Chanagan) 7G9N-3A053-BA

Ford (Chanagan) 7G9N-3A053-BB

Volvo 31200563

Volvo 31200775

Volvo 31200776

Volvo 31212781

Volvo 31212782

Volvo 31277343

Volvo 31277344

Volvo 31317661

Volvo 31317662

**Application info**

Ford Galaxy II (05/06-06/15)

Ford Mondeo IV (03/07-01/15)

Ford S-Max I (05/06-12/14)

Volvo S60 II / V60 (04/10--)

Volvo S80 II (03/06-12/16)

Volvo V70 III (04/07--)



**Ball joint**

716 010 0019

MBJ0295

**Notes**

Front Axle Left  
 Front Axle Right  
 Lower  
 2

Required quantity  
 replacement in pairs recommended



**References**

- |                       |                       |
|-----------------------|-----------------------|
| Ford 1 518 904        | Ford 1 520 778        |
| Ford 1 521 773        | Ford 1 532 421        |
| Ford 1 532 433        | Ford 1 540 724        |
| Ford 1 540 725        | Ford 1 700 809        |
| Ford 1 700 810        | Ford 1 708 222        |
| Ford 1 708 226        | Ford 1 712 696        |
| Ford 1 712 697        | Ford 1 737 305        |
| Ford 1 737 309        | Ford 8V51-3042-BH     |
| Ford USA 8V51-3042-BD | Ford USA 8V51-3042-BE |
| Ford USA 8V51-3042-BF | Ford USA 8V51-3042-BG |
| Ford USA 8V51-3051-BD | Ford USA 8V51-3051-BE |
| Ford USA 8V51-3051-BF | Ford USA 8V51-3051-BG |
| Mazda D651-34-300B    | Mazda D651-34-300C    |
| Mazda D651-34-300D    | Mazda D651-34-350     |
| Mazda D651-34-350A    | Mazda D651-34-350B    |
| Mazda D651-34-350C    | Mazda D651-34-350D    |
| Mazda D651-34-350E    |                       |

**Application info**

- |                          |                            |
|--------------------------|----------------------------|
| Ford Fiesta VI (06/08--) | Mazda 2 (DE) (07/07-06/15) |
|--------------------------|----------------------------|

**Ball joint** **716 010 0020** **MBJ0296**

**Notes**

Paired article number: 716 010 0021 | MBJ0297  
 Required quantity: 1  
 replacement in pairs recommended

Front Axle Left  
 with accessories



**References**

- |                     |                     |
|---------------------|---------------------|
| Ford 1 502 087      | Ford 1 723 324      |
| Ford 1 781 660      | Ford 1 793 237      |
| Ford 8V41-3A424-AB  | Ford 8V41-3A424-AC  |
| Ford CV61-3A424-AAB | Ford CV61-3A424-AAC |

**Application info**

Ford Kuga I (02/08-11/12) Ford Kuga II (05/12--)

**Ball joint** **716 010 0021** **MBJ0297**

**Notes**

Paired article number: 716 010 0020 | MBJ0296  
 Required quantity: 1  
 replacement in pairs recommended

Front Axle Right  
 with accessories



**References**

- |                     |                     |
|---------------------|---------------------|
| Ford 1 502 086      | Ford 1 723 323      |
| Ford 1 781 658      | Ford 1 793 236      |
| Ford 8V41-3A423-AB  | Ford 8V41-3A423-AC  |
| Ford CV61-3A423-AAB | Ford CV61-3A423-AAC |

**Application info**

Ford Kuga I (02/08-11/12) Ford Kuga II (05/12--)

**Ball joint** **716 010 0022** **MBJ0308**

**Notes**

Front Axle Right  
with accessories  
Paired article number 716 010 0023 | MBJ0309  
Required quantity 1  
replacement in pairs recommended



**References**

- |                     |                     |
|---------------------|---------------------|
| Ford 1 702 970      | Ford 1 709 457      |
| Ford 1 742 265      | Ford 1 742 266      |
| Ford 1 857 345      | Ford 1 865 168      |
| Ford 1 865 173      | Ford 1 866 068      |
| Ford 2 172 992      | Ford 2 173 539      |
| Ford AV61-3A423-LB  | Ford AV61-3A423-LC  |
| Ford BV61-3A423-AAB | Ford BV61-3A423-AAC |
| Ford BV61-3A423-AAD | Ford BV61-3A423-BAB |
| Ford BV61-3A423-BAC | Ford BV613-A424B-AB |
| Ford F1F1-3A423-AAA | Ford F1F1-3A423-AAB |

**Application info**

Ford C-Max II (04/10--)

Ford Focus III (07/10--)

**Ball joint** **716 010 0023** **MBJ0309**

**Notes**

Front Axle Left  
with accessories  
Paired article number 716 010 0022 | MBJ0308  
Required quantity 1  
replacement in pairs recommended



**References**

Ford 1 702 983	Ford 1 709 466
Ford 1 742 266	Ford 1 857 346
Ford 1 865 175	Ford 1 865 176
Ford 1 866 073	Ford 2 173 541
Ford 2 176 249	Ford AV61-3A424-LB
Ford AV61-3A424-LC	Ford BV61-3A424-AAB
Ford BV61-3A424-AAC	Ford BV61-3A424-AAD
Ford BV61-3A424-BAB	Ford BV61-3A424-BAC
Ford F1F1-3A424-AAA	Ford F1F1-3A424-AAB

**Application info**

Ford C-Max II (04/10--)	Ford Focus III (07/10--)
-------------------------	--------------------------

**Ball joint**

716 010 0026

MBJ0445

**Notes**

Front Axle Right  
 Lower  
 outer  
 Paired article number  
 716 010 0027 | MBJ0446  
 Required quantity  
 1  
 replacement in pairs recommended



**References**

Ford 1 773 516	Ford 1 805 952
Ford 1 866 070	Ford BV61-3A423-LAA
Ford BV61-3A423-LAB	Ford F1F13-A423B-AA

**Application info**

Ford Focus III (07/10--)
--------------------------

**Ball joint**

716 010 0027

MBJ0446

**Notes**

Front Axle Left  
Lower  
outer  
Paired article number 716 010 0026 | MBJ0445  
Required quantity 1  
replacement in pairs recommended



**References**

Ford 1 773 518 Ford 1 805 953  
Ford 1 866 072 Ford BV61-3A424-LAA  
Ford BV61-3A424-LAB Ford F1F1-3A424-BAA

**Application info**

Ford Focus III (07/10--)

**Ball joint**

716 010 0029

MBJ0477

**Notes**

Front Axle Left  
Front Axle Right  
Required quantity 2  
replacement in pairs recommended



**References**

Ford 2 084 192 Ford 2 084 194  
Ford 2 112 614 Ford 2 112 616  
Ford 2 201 370 Ford 2 201 372  
Ford H1BC-3042-AD Ford H1BC-3042-AE  
Ford H1BC-3051-AD Ford H1BC-3051-AE

**Application info**

Ford Fiesta VII (05/17--)

**Ball joint**

716 010 0032

MBJ0481

**Notes**

Front Axle Left  
Front Axle Right  
Lower

Required quantity  
replacement in pairs recommended

2



**References**

Ford 2 216 265  
Ford JX61-3A423-CEB

Ford 2 216 267  
Ford JX61-3A424-CEB

**Application info**

Ford Focus IV (01/18--)

**Ball joint**

716 010 0034/HD

MBJ0496HD

**Notes**

Carbon Neutral  
Front Axle Right  
Paired article number  
Required quantity  
only in connection with  
reinforced version  
replacement in pairs recommended

716 010 0035/HD | MBJ0497HD

1

716 050 0074/HD



**References**

Ford 1 927 131  
Ford 2 180 767  
Ford 5 303 328  
Ford FG9C3-A052A-NA  
Ford FG9C3-A052A-NC  
Ford FG9C3-A053A-NB

Ford 1 927 132  
Ford 2 180 769  
Ford 5 303 329  
Ford FG9C3-A052A-NB  
Ford FG9C3-A053A-NA  
Ford FG9C3-A053A-NC

**Application info**

Ford Mondeo V (09/12--)

**Ball joint**

716 010 0035/HD

MBJ0497HD

**Notes**

Carbon Neutral  
 Front Axle Left  
 Paired article number 716 010 0034/HD | MBJ0496HD  
 Required quantity 1  
 only in connection with 716 050 0073/HD  
 reinforced version  
 replacement in pairs recommended



**References**

- |                     |                     |
|---------------------|---------------------|
| Ford 1 927 131      | Ford 1 927 132      |
| Ford 2 180 767      | Ford 2 180 769      |
| Ford 5 303 328      | Ford 5 303 329      |
| Ford FG9C3-A052A-NA | Ford FG9C3-A052A-NB |
| Ford FG9C3-A052A-NC | Ford FG9C3-A053A-NA |
| Ford FG9C3-A053A-NB | Ford FG9C3-A053A-NC |

**Application info**

Ford Mondeo V (09/12--)

**Ball joint**

716 010 0036/HD

MBJ0508HD

**Notes**

Carbon Neutral  
 Front Axle Right  
 Lower  
 outer  
 Paired article number 716 010 0037/HD | MBJ0509HD  
 Required quantity 1  
 replacement in pairs recommended



**References**

- |                |                     |
|----------------|---------------------|
| Ford 1 877 652 | Ford E1GC-3A052-AEB |
|----------------|---------------------|

**Application info**

Ford Galaxy III (01/15--)	Ford S-Max II (01/15--)
---------------------------	-------------------------

**Ball joint** 716 010 0037/HD MBJ0509HD

**Notes**

Carbon Neutral  
 Front Axle Left  
 Lower  
 outer  
 Paired article number 716 010 0036/HD | MBJ0508HD  
 Required quantity 1  
 replacement in pairs recommended



**References**

Ford 1 877 653 Ford E1GC-3A053-AEB

**Application info**

Ford Galaxy III (01/15--)  
Ford S-Max II (01/15--)

**Ball joint** 716 010 4115 MBJ0298

**Notes**

Front Axle Left  
 Front Axle Right  
 Lower  
 with accessories  
 Cone Size [mm] 18  
 Length [mm] 25  
 Required quantity 2  
 replacement in pairs recommended





**References**

- |                   |                         |
|-------------------|-------------------------|
| Ford 1 023 026    | Ford 1 030 277          |
| Ford 1 030 278    | Ford 1 043 158          |
| Ford 1 043 159    | Ford 1 102 948          |
| Ford 1 102 949    | Ford 1 130 576          |
| Ford 1 130 577    | Ford 1 141 293          |
| Ford 1 141 294    | Ford 1 141 296          |
| Ford 1 679 390    | Ford 1M2J-A20164-ABYBD5 |
| Ford 6 790 117    | Ford 6 870 550          |
| Ford 6 870 551    | Ford 6 954 470          |
| Ford 6 954 471    | Ford 93BB-3042-BA       |
| Ford 93BB-3042-BB | Ford 93BB-3042-BC       |
| Ford 93BB-3051-BB | Ford 93BB-3051-BC       |
| Ford 93BB-3395-AC | Ford 95BG-3042-AA       |
| Ford 97BG-3042-AA | Ford 97BG-3042-BC       |
| Ford 97BG-3042-CA | Ford 97BG-3051-AA       |
| Ford 97BG-3051-BC | Ford 97BG-3051-CA       |
| Ford 99BB-3395-AC | Ford ME93BB-3395-AA     |
| Ford YS71-3042-AA | Ford YS71-3042-AB       |
| Ford YS71-3051-AA | Ford YS71-3051-AB       |

**Application info**

Ford Mondeo I, II (01/93-09/00)

**Ball joint**

816 010 0002

MBJ0299

**Notes**

Front Axle Left  
 Front Axle Right  
 Lower  
 with accessories

Cone Size [mm] 20  
 Required quantity 2  
 replacement in pairs recommended



**References**

Saab 52 37 516

**Application info**

Saab 9-5 (YS3E) (09/97-12/09)

Saab 9-5 (YS3G) (01/10-01/12)

**Ball joint****816 010 4903****MBJ0301****Notes**

Front Axle Left  
 Front Axle Right  
 Lower  
 with accessories

Cone Size [mm]

20

Length [mm]

13

Required quantity

2

Thread Size

M14x1,5

replacement in pairs recommended

**References**

Saab 89 57 045

Saab 89 72 135

Saab 89 94 212

**Application info**

Saab 9000 (09/84-12/98)

**Bracket, control arm****614 035 0037****MBC0005****Notes**

Front Axle Left  
 Front Axle Right  
 Lower  
 Rear  
 with accessories  
 with rubber mount

Inner Diameter [mm]

19

Required quantity

2

**References**

Fiat 51748652

Fiat 51748653

GENERAL MOTORS 9191175

GENERAL MOTORS 93171448

Opel 03 52 319

Opel 3 52 319

Saab 12 78 6412

Vauxhall 9191175

Vauxhall 93171448

**Application info**

Fiat Croma II (06/05--)

Opel Vectra C / Signum (04/02-01/09)

Saab 9-3 (YS3F) (09/02-02/15)

Vauxhall Vectra Mk II / Signum (01/00-05/09)

## Control arm

40-16 050 0002/HD

MCA0640HD

## Notes

Carbon Neutral  
Control Arm  
Front Axle Left  
Lower  
Sheet Steel  
with ball joint  
with rubber mount



Paired article number 40-16 050 0004/HD | MCA0641HD  
Replace in pairs only  
Required quantity 1  
reinforced version

## References

Citroën 16 144 183 80

Citroën 3520.A1

Citroën 3520.A6

Citroën 3520.F6

Citroën 3520.F8

Citroën 3520.H8

Citroën 95 658 882

Citroën 95 668 510

Peugeot 16 14 418 380

Peugeot 3520.H5

Citroën 16 144 476 80

Citroën 3520.A2

Citroën 3520.F5

Citroën 3520.F7

Citroën 3520.H5

Citroën 3520.K7

Citroën 95 658 884

Citroën 95 668 512

Peugeot 16 14 447 680

Peugeot 3520.K7

## Application info

Citroën Berlingo I (07/96-12/11)

Citroën ZX (03/91-07/99)

Peugeot Partner II (04/08--)

Citroën Xsara (04/97-03/10)

Peugeot Partner I (05/96--)

## Control arm

40-16 050 0004/HD

MCA0641HD

## Notes

Carbon Neutral  
Control Arm  
Front Axle Right  
Lower  
Sheet Steel  
with ball joint  
with rubber mount

Paired article number 40-16 050 0002/HD | MCA0640HD  
Replace in pairs only  
Required quantity 1  
reinforced version



## References





Citroën 16 144 184 80  
Citroën 3520.E8  
Citroën 3521.72  
Citroën 3521.A6  
Citroën 3521.A8  
Citroën 3521.G7  
Citroën 95 658 885  
Peugeot 16 14 418 480  
Peugeot 3521.E5

Citroën 16 144 477 80  
Citroën 3521.71  
Citroën 3521.A5  
Citroën 3521.A7  
Citroën 3521.E5  
Citroën 95 658 883  
Citroën 95 668 511  
Peugeot 16 14 447 780  
Peugeot 3521.G7

## Application info

Citroën Berlingo I (07/96-12/11)  
Citroën ZX (03/91-07/99)  
Peugeot Partner II (04/08--)

Citroën Xsara (04/97-03/10)  
Peugeot Partner I (05/96--)

Control arm		416 050 0025/HD	MCA1514HD
<b>Notes</b>  Aluminium Carbon Neutral Control Arm Front Front Axle Left Front Axle Right Lower  Hole Spacing 1/Hole Spacing 2 Length [mm] Replace in pairs only Required quantity reinforced version		  	
	210 mm/ 142,1 mm 352.1 2		
<b>References</b> Porsche 991 341 043 01 Porsche 991 341 043 02 Porsche 991 341 043 03 Porsche 991 341 043 04 Porsche 991 341 043 05 Porsche 991 341 043 06			
<b>Application info</b> Porsche 911 (991) (12/11--) Porsche Boxster (982) (04/16--) Porsche Cayman (982) (04/16--) Porsche Boxster (981) (04/12--) Porsche Cayman (981) (03/13--)			
Control arm		416 050 0026	MCA1446
<b>Notes</b>  Aluminium Control Arm Front Rear Rear Axle Left Rear Axle Right Upper  Required quantity replacement in pairs recommended		  	
		2	
<b>References</b> Porsche 970 331 043 00			
<b>Application info</b> Porsche Panamera (970) (03/09-12/17)			

**Control arm**

416 050 0027

MCA1447

**Notes**

Aluminium  
Centre  
Control Arm  
Rear Axle Left  
Rear Axle Right  
Upper

Required quantity  
replacement in pairs recommended

2



**References**

Porsche 970 331 047 00

**Application info**

Porsche Panamera (970) (03/09-12/17)

**Control arm**

44-16 050 0000

MCA0645

**Notes**

Control Arm  
Front Axle Left  
Lower  
Sheet Steel  
with ball joint  
with rubber mount

Paired article number  
Required quantity  
replacement in pairs recommended

44-16 050 0001 | MCA0646

1



**References**

Chrysler 04656731AH  
Chrysler 4656731AD  
Chrysler 4656731AL  
Chrysler 5272237  
Chrysler 5272237AC  
Chrysler 5272237AH  
Chrysler 5272237AK  
Chrysler 5272237AM  
Dodge 5272237AF  
Dodge 5272237AJ  
Dodge 5272237AL

Chrysler 04656731AN  
Chrysler 4656731AH  
Chrysler 4656731AN  
Chrysler 5272237AB  
Chrysler 5272237AF  
Chrysler 5272237AJ  
Chrysler 5272237AL  
Dodge 5272237AB  
Dodge 5272237AH  
Dodge 5272237AK  
Dodge 5272237AM

**Application info**

Chrysler Neon II (08/99-12/06)  
 Dodge Neon II (08/99--)

Chrysler PT Cruiser (06/00-12/10)

**Control arm**

44-16 050 0001

MCA0646

**Notes**

Control Arm  
 Front Axle Right  
 Lower  
 Sheet Steel  
 with ball joint  
 with rubber mount

Paired article number  
 Required quantity  
 replacement in pairs recommended

44-16 050 0000 | MCA0645  
 1



**References**

Chrysler 04656730AH  
 Chrysler 4656730AD  
 Chrysler 4656730AL  
 Chrysler 5272236  
 Chrysler 5272236AC  
 Chrysler 5272236AH  
 Chrysler 5272236AK  
 Chrysler 5272236AM  
 Dodge 5272236AF  
 Dodge 5272236AJ  
 Dodge 5272236AL

Chrysler 04656730AN  
 Chrysler 4656730AH  
 Chrysler 4656730AN  
 Chrysler 5272236AB  
 Chrysler 5272236AF  
 Chrysler 5272236AJ  
 Chrysler 5272236AL  
 Dodge 5272236AC  
 Dodge 5272236AH  
 Dodge 5272236AK  
 Dodge 5272236AM

**Application info**

Chrysler Neon II (08/99-12/06)  
 Dodge Neon II (08/99--)

Chrysler PT Cruiser (06/00-12/10)

**Control arm** 44-16 050 0008 MCA1124

**Notes**

Cast Steel  
 Control Arm  
 Front Axle Right  
 with ball joint  
 with rubber mount  
 Paired article number 44-16 050 0009 | MCA1125  
 Required quantity 1  
 replacement in pairs recommended



**References**

Chrysler 4766542AA Chrysler 4766542AD

**Application info**

Chrysler Voyager IV/ Town Country (09/99-12/08)

**Control arm** 44-16 050 0009 MCA1125

**Notes**

Cast Steel  
 Control Arm  
 Front Axle Left  
 with ball joint  
 with rubber mount  
 Paired article number 44-16 050 0008 | MCA1124  
 Required quantity 1  
 replacement in pairs recommended





**References**



Chrysler 4766543AA Chrysler 4766543AD

**Application info**

Chrysler Voyager IV/ Town Country (09/99-12/08)



Control arm		516 050 0000	MCA0652
<p><b>Notes</b></p> <p>Control Arm Front Axle Right Lower Sheet Steel with ball joint with rubber mount</p> <p>Paired article number Required quantity Thread Size replacement in pairs recommended</p>	<p>516 050 0009   MCA0659</p> <p>1</p> <p>M12x1,25</p>		
<p><b>References</b></p> <p>Volvo 30863989</p> <p>Volvo 30887654</p>			
<p><b>Application info</b></p> <p>Volvo S/V 40 (07/95-12/04)</p> <p>Volvo S40 II / V50 (12/03-12/12)</p>			
Control arm		516 050 0001	MCA0653
<p><b>Notes</b></p> <p>Control Arm Front Axle Left Lower Sheet Steel with ball joint with rubber mount</p> <p>Paired article number Required quantity Thread Size replacement in pairs recommended</p>	<p>516 050 0002   MCA0654</p> <p>1</p> <p>M12x1,25</p>		
<p><b>References</b></p> <p>Mitsubishi MN133617</p> <p>Mitsubishi MR179479</p> <p>Volvo 30821650</p> <p>Volvo 30863988</p> <p>Volvo 30887025</p> <p>Volvo 3088746</p> <p>Volvo 3088896</p> <p>Volvo 30888962</p>			
<p><b>Application info</b></p> <p>Mitsubishi Carisma (07/95-06/06)</p> <p>Volvo S/V 40 (07/95-12/04)</p>			

Control arm		516 050 0002	MCA0654
<p><b>Notes</b></p> <p>Control Arm Front Axle Right Lower Sheet Steel with ball joint with rubber mount</p> <p>Paired article number 516 050 0001   MCA0653 Required quantity 1 Thread Size M12x1,25 replacement in pairs recommended</p>			
<p><b>References</b></p> <p>Mitsubishi MN133618 Mitsubishi MR179480 Volvo 30821651 Volvo 30863989 Volvo 30887033 Volvo 3088747 Volvo 30889963</p>			
<p><b>Application info</b></p> <p>Mitsubishi Carisma (07/95-06/06) Volvo S/V 40 (07/95-12/04)</p>			
Control arm		516 050 0007/HD	MCA0657HD
<p><b>Notes</b></p> <p>Aluminium Carbon Neutral Control Arm Front Axle Left Lower with rubber mount</p> <p>Paired article number 516 050 0008/HD   MCA0658HD Replace in pairs only Required quantity 1 reinforced version</p>			
<p><b>References</b></p> <p>Volvo 30635227 Volvo 8623955 Volvo 8649541 Volvo 94616372 Volvo 9492105</p>			
<p><b>Application info</b></p> <p>Volvo S80 I (05/98-02/08)</p>			



<b>Control arm</b>	<b>516 050 0017/HD</b>	<b>MCA0665HD</b>
--------------------	------------------------	------------------

**Notes**

Aluminium  
 Carbon Neutral  
 Control Arm  
 Front Axle Left  
 Lower  
 with rubber mount

Paired article number  
 Replace in pairs only  
 Required quantity  
 reinforced version

1



**References**

Volvo 30635229	Volvo 30714752
Volvo 36012457	Volvo 36051002
Volvo 8623957	Volvo 8649543

**Application info**

Volvo S60 I / V70 II (11/99-04/10)

<b>Control arm</b>	<b>516 050 0018/HD</b>	<b>MCA0666HD</b>
--------------------	------------------------	------------------

**Notes**

Aluminium  
 Carbon Neutral  
 Control Arm  
 Front Axle Right  
 Lower  
 with rubber mount

Paired article number  
 Replace in pairs only  
 Required quantity  
 reinforced version

1



**References**

Volvo 30635230	Volvo 30714753
Volvo 36012458	Volvo 36051003
Volvo 8623958	Volvo 8649544

**Application info**

Volvo S60 I / V70 II (11/99-04/10)

**Control arm** 516 050 0019 MCA0667

**Notes**

Control Arm  
 Front Axle Left  
 Lower  
 Steel  
 with accessories  
 with rubber mount

Paired article number  
 Required quantity  
 replacement in pairs recommended

516 050 0020 | MCA0668  
 1



**References**

Volvo 8628499

**Application info**

Volvo C/S/V 70 (12/95-10/05)

**Control arm** 516 050 0020 MCA0668

**Notes**

Control Arm  
 Front Axle Right  
 Lower  
 Steel  
 with accessories  
 with rubber mount

Paired article number  
 Required quantity  
 replacement in pairs recommended

516 050 0019 | MCA0667  
 1



**References**

Volvo 8628500

**Application info**

Volvo C/S/V 70 (12/95-10/05)

<b>Control arm</b>	<b>516 050 0026/HD</b>	<b>MCA0671HD</b>
--------------------	------------------------	------------------

**Notes**

Carbon Neutral  
Control Arm  
Front Axle Right  
Lower  
Steel  
with rubber mount

Paired article number 516 050 0027/HD | MCA0672HD  
Replace in pairs only  
Required quantity 1  
reinforced version



**References**

Volvo 30639781	Volvo 30645846
Volvo 30681615	Volvo 31201005
Volvo 31304046	Volvo 36050810

**Application info**

Volvo XC90 I (06/02-01/15)

<b>Control arm</b>	<b>516 050 0027/HD</b>	<b>MCA0672HD</b>
--------------------	------------------------	------------------

**Notes**

Carbon Neutral  
Control Arm  
Front Axle Left  
Lower  
Steel  
with rubber mount

Paired article number 516 050 0026/HD | MCA0671HD  
Replace in pairs only  
Required quantity 1  
reinforced version





**References**

Volvo 30639780	Volvo 30645845
Volvo 31201004	Volvo 31304045
Volvo 36050809	

**Application info**

Volvo XC90 I (06/02-01/15)



Control arm		516 050 0030/HD	MCA0673HD
<p><b>Notes</b></p> <p>Carbon Neutral Cast Steel Control Arm Front Axle Left with rubber mount</p> <p>Paired article number Replace in pairs only Required quantity reinforced version</p>			
<p><b>References</b></p> <p>Volvo 30760586</p>			
<p><b>Application info</b></p> <p>Volvo S60 I / V70 II (11/99-04/10)</p>			
Control arm		516 050 0031/HD	MCA0674HD
<p><b>Notes</b></p> <p>Carbon Neutral Cast Steel Control Arm Front Axle Right with rubber mount</p> <p>Paired article number Replace in pairs only Required quantity reinforced version</p>			
<p><b>References</b></p> <p>Volvo 30760587</p>			
<p><b>Application info</b></p> <p>Volvo S60 I / V70 II (11/99-04/10)</p>			



Control arm		516 050 0032	MCA1084
<p><b>Notes</b></p> <p>Aluminium Control Arm Front Axle Right Lower with rubber mount</p> <p>Paired article number Required quantity replacement in pairs recommended</p>			
<p><b>References</b></p> <p>Volvo 30635230 Volvo 8623958</p>		<p>Volvo 30714753 Volvo 8649544</p>	
<p><b>Application info</b></p> <p>Volvo S60 I / V70 II (11/99-04/10)</p>			
Control arm		516 050 0033	MCA1085
<p><b>Notes</b></p> <p>Aluminium Control Arm Front Axle Left Lower with rubber mount</p> <p>Paired article number Required quantity replacement in pairs recommended</p>			
<p><b>References</b></p> <p>Volvo 30635229 Volvo 8623957</p>		<p>Volvo 30714752 Volvo 8649543</p>	
<p><b>Application info</b></p> <p>Volvo S60 I / V70 II (11/99-04/10)</p>			

## Control arm

516 050 0036/HD

MCA1586HD

## Notes

Carbon Neutral  
Control Arm  
Front Axle Right  
Lower  
Sheet Steel  
outer

Length [mm] 363.5  
Paired article number 516 050 0037/HD | MCA1587HD  
Replace in pairs only  
Required quantity 1  
Width [mm] 304  
reinforced version



## References

Volvo 30683249  
Volvo 31277346

Volvo 31202229  
Volvo 31317664

## Application info

Volvo S60 II / V60 (04/10--)

Volvo XC70 II (04/07-12/16)

## Control arm

516 050 0037/HD

MCA1587HD

## Notes

Carbon Neutral  
Control Arm  
Front Axle Left  
Lower  
Sheet Steel  
outer

Length [mm] 363.5  
Paired article number 516 050 0036/HD | MCA1586HD  
Replace in pairs only  
Required quantity 1  
Width [mm] 304  
reinforced version



## References



Volvo 30683248  
Volvo 31277345

Volvo 31202228  
Volvo 31317663

## Application info

Volvo S60 II / V60 (04/10--)

Volvo XC70 II (04/07-12/16)

Control arm		516 050 0038/HD	MCA1582HD
<p><b>Notes</b></p> <p>Carbon Neutral Control Arm Front Axle Right Lower Sheet Steel</p> <p>Paired article number Replace in pairs only Required quantity reinforced version</p>	<p>516 050 0039/HD   MCA1583HD</p> <p>1</p>		
<p><b>References</b></p> <p>Volvo 31277621 <span style="float: right;">Volvo 31340231</span></p>			
<p><b>Application info</b></p> <p>Volvo V40 II (03/12--)</p>			
Control arm		516 050 0039/HD	MCA1583HD
<p><b>Notes</b></p> <p>Carbon Neutral Control Arm Front Axle Left Lower Sheet Steel</p> <p>Paired article number Replace in pairs only Required quantity reinforced version</p>	<p>516 050 0038/HD   MCA1582HD</p> <p>1</p>		
<p><b>References</b></p> <p>Volvo 31277620 <span style="float: right;">Volvo 31340232</span></p>			
<p><b>Application info</b></p> <p>Volvo V40 II (03/12--)</p>			

**Control arm**

516 050 0040

MCA1210

**Notes**

Rear Axle Left  
Rear Axle Right  
Semi-Trailing Arm  
Sheet Steel

Required quantity  
replacement in pairs recommended

2

**References**

Ford 1 719 007

Ford 1 787 961

Ford 1 894 048

Ford BV61-5K652-CD

Ford BV61-5K652-CF

Ford BV61-5K652-CH

Volvo 31387063

Ford 1 744 422

Ford 1 882 882

Ford 1 949 978

Ford BV61-5K652-CE

Ford BV61-5K652-CG

Ford F1F1-5K652-CA

**Application info**

Ford C-Max II (04/10--)

Volvo V40 II (03/12--)

Ford Focus III (07/10--)

**Control arm**

516 050 0054/HD

MCA1596HD

**Notes**

Aluminium  
Carbon Neutral  
Control Arm  
Front Axle Right  
Upper

Bore Diameter [mm]

10

Length [mm]

187

Paired article number

516 050 0055/HD | MCA1597HD

Replace in pairs only

Required quantity

1

Width [mm]

188

reinforced version

**References**

Volvo 31476302

Volvo 32395247

**Application info**

Volvo S60 III (224) (02/19--)

Volvo V60 II (02/18--)

**Control arm**

516 050 0055/HD

MCA1597HD

**Notes**

Aluminium  
Carbon Neutral  
Control Arm  
Front Axle Left  
Upper

Bore Diameter [mm] 10  
Length [mm] 187  
Paired article number 516 050 0054/HD | MCA1596HD  
Replace in pairs only  
Required quantity 1  
Width [mm] 188  
reinforced version



**References**

Volvo 31476301

Volvo 32395246

**Application info**

Volvo S60 III (224) (02/19--)

Volvo V60 II (02/18--)

**Control arm**

516 050 0100/HD

MCA1671HD

**Notes**

Control Arm  
Front Axle Right  
Lower  
Steel

Paired article number 516 050 0101/HD | MCA1672HD  
Replace in pairs only  
Required quantity 1  
reinforced version



**References**

Volvo 271629

Volvo 271902

Volvo 8628492

Volvo 8628496

Volvo 9492288

Volvo 9492531



Volvo 9492672



Volvo 9492915

**Application info**

Volvo 850 (06/91-10/97)

Volvo C/S/V 70 (12/95-10/05)

Control arm		516 050 0101/HD	MCA1672HD
<p><b>Notes</b></p> <p>Control Arm Front Axle Left Lower Steel</p> <p>Paired article number Replace in pairs only Required quantity reinforced version</p>			
<p><b>References</b></p> <p>Volvo 271628 Volvo 8628491 Volvo 9492287 Volvo 9492671</p>		<p>Volvo 271901 Volvo 8628495 Volvo 9492530 Volvo 9492914</p>	
<p><b>Application info</b></p> <p>Volvo 850 (06/91-10/97)</p>		<p>Volvo C/S/V 70 (12/95-10/05)</p>	
Control arm		516 050 7003	MCA0675
<p><b>Notes</b></p> <p>Control Arm Front Axle Left Lower Steel with accessories</p> <p>Length [mm] Paired article number Required quantity replacement in pairs recommended</p>			
<p><b>References</b></p> <p>Volvo 2722734 Volvo 8628493 Volvo 9492673</p>		<p>Volvo 272336 Volvo 8628497 Volvo 9492916</p>	
<p><b>Application info</b></p> <p>Volvo 850 (06/91-10/97)</p>		<p>Volvo C/S/V 70 (12/95-10/05)</p>	

Control arm		516 050 7004	MCA0676
<b>Notes</b>  Control Arm Front Axle Right Lower Steel with accessories  Length [mm] 284 Paired article number 516 050 7003   MCA0675 Required quantity 1 replacement in pairs recommended			
<b>References</b> Volvo 2722742 Volvo 272337 Volvo 8628494 Volvo 8628498 Volvo 9492674 Volvo 9492917			
<b>Application info</b> Volvo 850 (06/91-10/97) Volvo C/S/V 70 (12/95-10/05)			
Control arm		53-16 050 0005/HD	MCA1284HD
<b>Notes</b>  Carbon Neutral Control Arm Front Axle Left Sheet Steel  Paired article number 53-16 050 0006/HD   MCA1285HD Replace in pairs only Required quantity 1 reinforced version			
<b>References</b> Land Rover LR002625 Land Rover LR007206			
<b>Application info</b> Land Rover Freelander II (10/06-12/15)			

<b>Control arm</b>	<b>53-16 050 0006/HD</b>	<b>MCA1285HD</b>
--------------------	--------------------------	------------------

<p><b>Notes</b></p> <p>Carbon Neutral Control Arm Front Axle Right Sheet Steel</p> <p>Paired article number Replace in pairs only Required quantity reinforced version</p>	 <p>A black metal control arm for the front right axle, featuring a ball joint at the top and a rubber mount at the bottom. A yellow 'MEYLE HD' badge is visible in the top right corner of the image area.</p>
--	--

<b>References</b>	
Land Rover LR002624	Land Rover LR007205

<b>Application info</b>
Land Rover Freelander II (10/06-12/15)

<b>Control arm</b>	<b>53-16 050 0009/HD</b>	<b>MCA1018HD</b>
--------------------	--------------------------	------------------

<p><b>Notes</b></p> <p>Carbon Neutral Control Arm Front Axle Left Lower Sheet Steel with ball joint with rubber mount</p> <p>Paired article number Replace in pairs only Required quantity reinforced version</p>	 <p>A black metal control arm for the front left axle, featuring a ball joint at the top and a rubber mount at the bottom. A yellow 'MEYLE HD' badge is visible in the top right corner of the image area.</p>
---	---



**References**

- |                      |                      |
|----------------------|----------------------|
| Land Rover LR014138  | Land Rover LR014674  |
| Land Rover LR025613  | Land Rover LR025618  |
| Land Rover LR028249  | Land Rover LR028252  |
| Land Rover LR029302  | Land Rover LR029306  |
| Land Rover LR051584  | Land Rover LR071929  |
| Land Rover LR073369  | Land Rover LR075995  |
| Land Rover RBJ500193 | Land Rover RBJ500456 |
| Land Rover RBJ501250 | Land Rover RBJ501290 |
| Land Rover RBJ501350 | Land Rover RBJ501390 |
| Land Rover RBJ501470 | Land Rover RBJ501510 |
| Land Rover RBJ501550 | Land Rover RBJ501610 |

**Application info**

- |  |                                       |
|--|---------------------------------------|
| Land Rover Discovery III (07/04-09/09)       | Land Rover Discovery IV (09/09-12/18) |
| Land Rover Range Rover Sport I (02/05-03/13) |                                       |

**Control arm**

53-16 050 0010/HD

MCA1019HD

**Notes**

Carbon Neutral  
Control Arm  
Front Axle Right  
Lower  
Sheet Steel  
with ball joint  
with rubber mount

Paired article number 53-16 050 0009/HD | MCA1018HD  
Replace in pairs only  
Required quantity 1  
reinforced version



**References**

- |                      |                      |
|----------------------|----------------------|
| Land Rover LR014136  | Land Rover LR014673  |
| Land Rover LR025610  | Land Rover LR025617  |
| Land Rover LR028245  | Land Rover LR028248  |
| Land Rover LR029301  | Land Rover LR029304  |
| Land Rover LR051583  | Land Rover LR071166  |
| Land Rover LR073367  | Land Rover LR075993  |
| Land Rover RBJ500183 | Land Rover RBJ500446 |
| Land Rover RBJ501240 | Land Rover RBJ501280 |
| Land Rover RBJ501340 | Land Rover RBJ501380 |
| Land Rover RBJ501500 | Land Rover RBJ501540 |
| Land Rover RBJ501600 |                      |

**Application info**

Land Rover Discovery III (07/04-09/09)  
 Land Rover Range Rover Sport I (02/05-03/13)

Land Rover Discovery IV (09/09-12/18)

**Control arm**

53-16 050 0020/HD

MCA1257HD

**Notes**

Aluminium  
 Carbon Neutral  
 Control Arm  
 Front Axle Right  
 Lower

Paired article number 53-16 050 0021/HD | MCA1258HD  
 Replace in pairs only  
 Required quantity 1  
 reinforced version



**References**

Land Rover LR024472  
 Land Rover LR073521

Land Rover LR045803  
 Land Rover LR078656

**Application info**

Land Rover Discovery Sport (09/14--)

Land Rover Range Rover Evoque I (06/11-12/19)

**Control arm**

53-16 050 0021/HD

MCA1258HD

**Notes**

Aluminium  
 Carbon Neutral  
 Control Arm  
 Front Axle Left  
 Lower

Paired article number 53-16 050 0020/HD | MCA1257HD  
 Replace in pairs only  
 Required quantity 1  
 reinforced version



**References**

Land Rover LR024473  
 Land Rover LR073522

Land Rover LR045802  
 Land Rover LR078657

**Application info**

Land Rover Discovery Sport (09/14--)

Land Rover Range Rover Evoque I (06/11-12/19)

Control arm		53-16 050 0027/HD	MCA1191HD
<b>Notes</b>	<p>Aluminium Carbon Neutral Control Arm Front Axle Left Upper can be adjusted three times</p>		
Paired article number	53-16 050 0028/HD   MCA1192HD		
Replace in pairs only			
Required quantity reinforced version	1		

References	
Land Rover LR034214	Land Rover LR034215
Land Rover LR034216	Land Rover LR044844
Land Rover LR044845	Land Rover LR044846
Land Rover LR108766	Land Rover LR113265
Land Rover LR113266	Land Rover LR113267
Land Rover LR113268	Land Rover LR113270
Land Rover LR113271	Land Rover LR125711
Land Rover LR125712	Land Rover LR125713
Land Rover LR125714	Land Rover LR139240
Land Rover LR148193	

Application info	
Land Rover Discovery V (09/16--)	Land Rover Range Rover IV (08/12--)
Land Rover Range Rover Sport II (04/13--)	

Control arm		53-16 050 0028/HD	MCA1192HD
<b>Notes</b>	<p>Aluminium Carbon Neutral Control Arm Front Axle Right Upper can be adjusted three times</p>		
Paired article number	53-16 050 0027/HD   MCA1191HD		
Replace in pairs only			
Required quantity reinforced version	1		

**References**

- |                     |                     |
|---------------------|---------------------|
| Land Rover LR034211 | Land Rover LR034212 |
| Land Rover LR034213 | Land Rover LR044841 |
| Land Rover LR044842 | Land Rover LR044843 |
| Land Rover LR108765 | Land Rover LR113259 |
| Land Rover LR113260 | Land Rover LR113261 |
| Land Rover LR113262 | Land Rover LR113263 |
| Land Rover LR113264 | Land Rover LR125697 |
| Land Rover LR125698 | Land Rover LR125701 |
| Land Rover LR125702 | Land Rover LR139239 |
| Land Rover LR148192 |                     |

**Application info**

- |   |                                     |
|---|-------------------------------------|
| Land Rover Discovery V (09/16--)          | Land Rover Range Rover IV (08/12--) |
| Land Rover Range Rover Sport II (04/13--) |                                     |

**Control arm**

53-16 050 0049

MCA1389

**Notes**

- |                                  |                          |
|----------------------------------|--------------------------|
|                                  | Control Arm              |
|                                  | Lower                    |
|                                  | Rear Axle Left           |
|                                  | Sheet Steel              |
| Paired article number            | 53-16 050 0050   MCA1390 |
| Required quantity                | 1                        |
| replacement in pairs recommended |                          |







**References**

- |                     |                     |
|---------------------|---------------------|
| Jaguar J9C18609     | Jaguar J9C4821      |
| Land Rover LR068167 | Land Rover LR097278 |
| Land Rover LR125868 |                     |

**Application info**

- |                                |                                      |
|--------------------------------|--------------------------------------|
| Jaguar E-Pace (X540) (09/17--) | Land Rover Discovery Sport (09/14--) |
|--------------------------------|--------------------------------------|

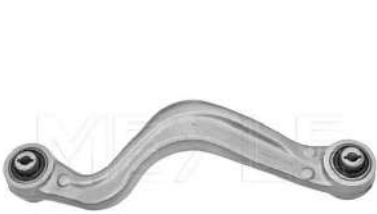
Control arm		53-16 050 0050	MCA1390
<p><b>Notes</b></p> <p>Control Arm Lower Rear Axle Right Sheet Steel</p> <p>Paired article number Required quantity replacement in pairs recommended</p>			
<p><b>References</b></p> <p>Jaguar J9C18608 Land Rover LR068166 Land Rover LR125871</p>		<p>Jaguar J9C4820 Land Rover LR097279</p>	
<p><b>Application info</b></p> <p>Jaguar E-Pace (X540) (09/17--)</p>		<p>Land Rover Discovery Sport (09/14--)</p>	
Control arm		53-16 050 0053	MCA1532
<p><b>Notes</b></p> <p>Aluminium Control Arm Rear Axle Left Rear Axle Right Upper</p> <p>Bore Diameter [mm] Length [mm] Required quantity replacement in pairs recommended</p>			
<p><b>References</b></p> <p>Land Rover CPLA5500BA Land Rover LR139241</p>		<p>Land Rover LR037690</p>	
<p><b>Application info</b></p> <p>Land Rover Discovery V (09/16--) Land Rover Range Rover Sport II (04/13--)</p>		<p>Land Rover Range Rover IV (08/12--)</p>	

Control arm		53-16 050 0055	MCA1448
<b>Notes</b>  Aluminium Control Arm Rear Rear Axle Left Upper  Bore Diameter [mm] 12.3 Length [mm] 363 Paired article number 53-16 050 0056   MCA1449 Required quantity 1 replacement in pairs recommended			
<b>References</b> Jaguar J9C1717 Land Rover LR060768 Land Rover LR073526 Land Rover LR078520			
<b>Application info</b> Jaguar E-Pace (X540) (09/17--) Land Rover Discovery Sport (09/14--) Land Rover Range Rover Evoque II (12/18--)			
Control arm		53-16 050 0056	MCA1449
<b>Notes</b>  Aluminium Control Arm Rear Rear Axle Right Upper  Bore Diameter [mm] 12.3 Length [mm] 363 Paired article number 53-16 050 0055   MCA1448 Required quantity 1 replacement in pairs recommended			
<b>References</b> Jaguar J9C1348 Land Rover LR060763 Land Rover LR073525 Land Rover LR078519 Land Rover LR117513			
<b>Application info</b> Jaguar E-Pace (X540) (09/17--) Land Rover Discovery Sport (09/14--) Land Rover Range Rover Evoque II (12/18--)			

## Control arm

53-16 050 0057/HD

MCA1590HD

## Notes

Carbon Neutral

Control Arm

Front Axle Left

Lower

Sheet Steel

Length [mm]

362

Paired article number

53-16 050 0058/HD | MCA1591HD

Replace in pairs only

Required quantity

1

Width [mm]

230.8

reinforced version



## References

Jaguar J9C13932

Jaguar J9C2117

Jaguar J9C33A053AD

Land Rover FK723A053AD

Land Rover FK723A053AF

Land Rover FK723A053AJ

Land Rover J9C33A053AB

Land Rover J9C33A053AD

Land Rover LR060047

Land Rover LR096362

Land Rover LR104885

Land Rover LR110313

Land Rover LR117141

Jaguar J9C19215

Jaguar J9C33A053AC

Jaguar J9C33A053AE

Land Rover FK723A053AE

Land Rover FK723A053AH

Land Rover FK723A053AK

Land Rover J9C33A053AC

Land Rover J9C33A053AE

Land Rover LR086108

Land Rover LR101812

Land Rover LR110278

Land Rover LR115123

Land Rover LR126119

## Application info

Jaguar E-Pace (X540) (09/17--)

Land Rover Range Rover Evoque I (06/11-12/19)

Land Rover Discovery Sport (09/14--)

## Control arm

53-16 050 0058/HD

MCA1591HD

## Notes

Carbon Neutral  
Control Arm  
Front Axle Right  
Lower  
Sheet Steel

Length [mm] 362  
Paired article number 53-16 050 0057/HD | MCA1590HD  
Replace in pairs only  
Required quantity 1  
Width [mm] 230.8  
reinforced version





## References



Jaguar J9C13931	Jaguar J9C19214
Jaguar J9C2115	Jaguar J9C33A052AB
Jaguar J9C33A052AC	Jaguar J9C33A052AD
Jaguar J9C33A052AE	Land Rover FK723A052AD
Land Rover FK723A052AE	Land Rover FK723A052AF
Land Rover FK723A052AJ	Land Rover FK723A052AK
Land Rover J9C33A052AB	Land Rover J9C33A052AC
Land Rover J9C33A052AD	Land Rover J9C33A052AE
Land Rover LR060046	Land Rover LR086107
Land Rover LR096363	Land Rover LR101811
Land Rover LR104884	Land Rover LR110277
Land Rover LR110312	Land Rover LR115121
Land Rover LR117140	Land Rover LR126118

## Application info

Jaguar E-Pace (X540) (09/17--)	Land Rover Discovery Sport (09/14--)
Land Rover Range Rover Evoque I (06/11-12/19)	



Control arm		57-16 050 0000	MCA1126
<b>Notes</b>  Paired article number Required quantity replacement in pairs recommended		Control Arm Front Axle Left Grey Cast Iron Lower  57-16 050 0001   MCA1127 1	
			
<b>References</b> Jeep 52089981AD Jeep 52089981AF Jeep 52089981AG Jeep 52089981AI			
<b>Application info</b> Jeep Commander (XK) (09/05-12/10) Jeep Grand Cherokee (WH) (10/04-10/11)			
Control arm		57-16 050 0001	MCA1127
<b>Notes</b>  Paired article number Required quantity replacement in pairs recommended		Control Arm Front Axle Right Grey Cast Iron Lower  57-16 050 0000   MCA1126 1	
			
<b>References</b> Jeep 52089980AD Jeep 52089980AF Jeep 52089980AG Jeep 52089980AI			
<b>Application info</b> Jeep Commander (XK) (09/05-12/10) Jeep Grand Cherokee (WH) (10/04-10/11)			

Control arm		57-16 050 0004	MCA1519
<p><b>Notes</b></p> <p>Control Arm Lower Rear Axle Left Rear Axle Right Steel Pipe outer</p> <p>Required quantity replacement in pairs recommended</p>			
<p><b>References</b></p> <p>Jeep 52060021AD                      Jeep 52060021AE                      Jeep 52060021AF                      Jeep K52060021AD                      Jeep K52060021AE                      Jeep K52060021AF</p>			
<p><b>Application info</b></p> <p>Jeep Wrangler (JK) (06/06--)</p>			
Control arm		57-16 050 0006	MSR0154
<p><b>Notes</b></p> <p>Front Rear Axle Left Rear Axle Right Semi-Trailing Arm Steel for left-hand drive vehicles</p> <p>Length [mm] Required quantity replacement in pairs recommended</p>			
<p><b>References</b></p> <p>Fiat 51945317                              Fiat 52004330                      Fiat 52025627                              Jeep 51945317                      Jeep 6830 9200 AA                        Jeep K6830 9200 AA</p>			
<p><b>Application info</b></p> <p>Fiat 500X (09/14--)</p> <p>Jeep Renegade (BU, B1) (07/14--)</p> <p>Jeep Compass (MP) (01/16--)</p>			

<b>Control arm</b>	<b>616 050 0001</b>	<b>MCA0680</b>
--------------------	---------------------	----------------

**Notes**

Aluminium  
Control Arm  
Front Axle Left  
Lower  
with rubber mount  
Paired article number 616 050 0002 | MCA0681  
Required quantity 1  
replacement in pairs recommended



**References**

Fiat 51748653	GENERAL MOTORS 13225798
GENERAL MOTORS 24413015	Opel 03 52 051
Opel 03 52 081	Opel 3 52 051
Opel 3 52 081	Saab 12 78 0952
Saab 12 78 3757	Saab 12 79 6013
Saab 12 79 9199	Vauxhall 03 52 051
Vauxhall 3 52 051	Vauxhall 3 52 081

**Application info**

Fiat Croma II (06/05--)	Opel Vectra C / Signum (04/02-01/09)
Saab 9-3 (YS3F) (09/02-02/15)	Vauxhall Vectra Mk II / Signum (01/00-05/09)

<b>Control arm</b>	<b>616 050 0002</b>	<b>MCA0681</b>
--------------------	---------------------	----------------

**Notes**

Aluminium  
Control Arm  
Front Axle Right  
Lower  
with rubber mount  
Paired article number 616 050 0001 | MCA0680  
Required quantity 1  
replacement in pairs recommended



**References**

Fiat 51748652  
 GENERAL MOTORS 24413016  
 Opel 03 52 082  
 Opel 3 52 082  
 Saab 12 78 3758  
 Saab 12 79 9200  
 Vauxhall 3 52 052

GENERAL MOTORS 13225799  
 Opel 03 52 052  
 Opel 3 52 052  
 Saab 12 78 0953  
 Saab 12 79 6014  
 Vauxhall 03 52 052  
 Vauxhall 3 52 082

**Application info**

Fiat Croma II (06/05--)  
 Saab 9-3 (YS3F) (09/02-02/15)

Opel Vectra C / Signum (04/02-01/09)  
 Vauxhall Vectra Mk II / Signum (01/00-05/09)

**Control arm**

616 050 0009/HD

MCA0686HD

**Notes**

Carbon Neutral  
 Control Arm  
 Front Axle Left  
 Sheet Steel  
 with ball joint  
 with rubber mount

Paired article number 616 050 0010/HD | MCA0687HD  
 Replace in pairs only  
 Required quantity 1  
 reinforced version



**References**

GENERAL MOTORS 90473224  
 GENERAL MOTORS 90495103  
 GENERAL MOTORS 90495161  
 Opel 03 52 193  
 Opel 3 52 077  
 Opel 53 52 001  
 Vauxhall 03 52 077  
 Vauxhall 3 52 077  
 Vauxhall 53 52 001

GENERAL MOTORS 90473226  
 GENERAL MOTORS 90495159  
 Opel 03 52 077  
 Opel 3 52 075  
 Opel 3 52 193  
 Opel 53 52 015  
 Vauxhall 03 52 193  
 Vauxhall 3 52 193  
 Vauxhall 53 52 015

**Application info**

Opel Astra F (09/91-01/05)  
 Opel Vectra A (04/88-12/95)  
 Vauxhall Calibra Mk I (06/90-07/97)

Opel Calibra (08/89-07/97)  
 Vauxhall Astra Mk III (01/91-03/01)  
 Vauxhall Cavalier Mk III (08/88-11/95)

**Control arm**

616 050 0010/HD

MCA0687HD

**Notes**

Carbon Neutral  
Control Arm  
Front Axle Right  
Sheet Steel  
with ball joint  
with rubber mount

Paired article number 616 050 0009/HD | MCA0686HD  
Replace in pairs only  
Required quantity 1  
reinforced version



**References**

GENERAL MOTORS 90373262  
GENERAL MOTORS 90473227  
GENERAL MOTORS 90495160  
Opel 03 52 076  
Opel 3 52 074  
Opel 3 52 166  
Opel 53 52 000  
Vauxhall 03 52 076  
Vauxhall 3 52 076  
Vauxhall 53 52 000

GENERAL MOTORS 90473225  
GENERAL MOTORS 90495104  
GENERAL MOTORS 90495162  
Opel 03 52 192  
Opel 3 52 076  
Opel 3 52 192  
Opel 53 52 018  
Vauxhall 03 52 192  
Vauxhall 3 52 192  
Vauxhall 53 52 018

**Application info**

Opel Astra F (09/91-01/05)  
Opel Vectra A (04/88-12/95)  
Vauxhall Calibra Mk I (06/90-07/97)

Opel Calibra (08/89-07/97)  
Vauxhall Astra Mk III (01/91-03/01)  
Vauxhall Cavalier Mk III (08/88-11/95)

**Control arm**

616 050 0011

MCA0688

**Notes**

Control Arm  
Front Axle Right  
Lower  
Sheet Steel  
with ball joint  
with rubber mount

Paired article number 616 050 0012 | MCA0689  
Required quantity 1  
replacement in pairs recommended



**References**

GENERAL MOTORS 13140038  
 GENERAL MOTORS 24428978  
 Opel 03 52 042  
 Opel 03 52 063  
 Opel 3 52 042  
 Opel 3 52 063  
 Vauxhall 03 52 042  
 Vauxhall 03 52 063  
 Vauxhall 3 52 042  
 Vauxhall 3 52 063

GENERAL MOTORS 13140040  
 GENERAL MOTORS 24449455  
 Opel 03 52 046  
 Opel 03 52 065  
 Opel 3 52 046  
 Opel 3 52 065  
 Vauxhall 03 52 046  
 Vauxhall 03 52 065  
 Vauxhall 3 52 046  
 Vauxhall 3 52 065

**Application info**

Opel Corsa C / Combo / Tigra (09/00--)

Vauxhall Combo Mk II (09/01-02/12)

Vauxhall Corsa Mk II / Tigra / Combo (08/00-02/12)

**Control arm**

616 050 0012

MCA0689

**Notes**

Control Arm  
 Front Axle Left  
 Lower  
 Sheet Steel  
 with ball joint  
 with rubber mount

Paired article number 616 050 0011 | MCA0688  
 Required quantity 1  
 replacement in pairs recommended



**References**

GENERAL MOTORS 13140037  
 GENERAL MOTORS 24428977  
 Opel 03 52 041  
 Opel 03 52 061  
 Opel 3 52 041  
 Opel 3 52 061  
 Vauxhall 03 52 041  
 Vauxhall 03 52 061  
 Vauxhall 3 52 041  
 Vauxhall 3 52 061

GENERAL MOTORS 13140039  
 GENERAL MOTORS 24449453  
 Opel 03 52 045  
 Opel 03 52 064  
 Opel 3 52 045  
 Opel 3 52 064  
 Vauxhall 03 52 045  
 Vauxhall 03 52 064  
 Vauxhall 3 52 045  
 Vauxhall 3 52 064

**Application info**

Opel Corsa C / Combo / Tigra (09/00--)

Vauxhall Combo Mk II (09/01-02/12)

Vauxhall Corsa Mk II / Tigra / Combo (08/00-02/12)

<b>Control arm</b>	<b>616 050 0015</b>	<b>MCA0690</b>
--------------------	---------------------	----------------

<p><b>Notes</b></p> <p style="margin-left: 20px;">Aluminium Control Arm Front Axle Left with rubber mount</p> <p>Paired article number: 616 050 0016   MCA0691</p> <p>Required quantity: 1</p> <p>replacement in pairs recommended</p>	 <p>A photograph of a grey aluminium control arm for the front left axle. It features a ball joint at the top and a rubber bush at the bottom. A blue circular 'MEYLE ORIGINAL' logo is visible in the top right corner of the image area.</p>
--	---

<b>References</b>	
<p>GENERAL MOTORS 13273604</p> <p>GENERAL MOTORS 13318884</p> <p>GENERAL MOTORS 13360017</p> <p>GENERAL MOTORS 23354434</p> <p>Opel 3 52 050</p> <p>Opel 3 52 520</p> <p>Opel 3 52 869</p> <p>Saab 13 318 886</p> <p>Vauxhall 13 28 0210</p> <p>Vauxhall 13 31 8886</p> <p>Vauxhall 22 79 2990</p> <p>Vauxhall 23 36 1708</p>	<p>GENERAL MOTORS 13280210</p> <p>GENERAL MOTORS 13318886</p> <p>GENERAL MOTORS 22792990</p> <p>GENERAL MOTORS 23361708</p> <p>Opel 3 52 073</p> <p>Opel 3 52 560</p> <p>Opel 3 52 871</p> <p>Vauxhall 13 27 3604</p> <p>Vauxhall 13 31 8884</p> <p>Vauxhall 13 36 0017</p> <p>Vauxhall 23 35 4434</p>

<b>Application info</b>	
<p>Opel Insignia A (07/08-03/17)</p> <p>Vauxhall Insigna Mk I A (07/08-05/17)</p>	<p>Saab 9-5 (YS3G) (01/10-01/12)</p>

<b>Control arm</b>	<b>616 050 0016</b>	<b>MCA0691</b>
--------------------	---------------------	----------------

<p><b>Notes</b></p> <p style="margin-left: 20px;">Aluminium Control Arm Front Axle Right with rubber mount</p> <p>Paired article number: 616 050 0015   MCA0690</p> <p>Required quantity: 1</p> <p>replacement in pairs recommended</p>	 <p>A photograph of a grey aluminium control arm for the front right axle. It features a ball joint at the top and a rubber bush at the bottom. A blue circular 'MEYLE ORIGINAL' logo is visible in the top right corner of the image area.</p>
---	--

**References**

GENERAL MOTORS 13273605  
 GENERAL MOTORS 13318885  
 GENERAL MOTORS 13360020  
 GENERAL MOTORS 23354435  
 Opel 3 52 071  
 Opel 3 52 521  
 Opel 3 52 870  
 Saab 13 318 887  
 Vauxhall 13 28 0211  
 Vauxhall 13 31 8887  
 Vauxhall 22 79 2991  
 Vauxhall 23 36 1709

GENERAL MOTORS 13280211  
 GENERAL MOTORS 13318887  
 GENERAL MOTORS 22792991  
 GENERAL MOTORS 23361709  
 Opel 3 52 080  
 Opel 3 52 561  
 Opel 3 52 872  
 Vauxhall 13 27 3605  
 Vauxhall 13 31 8885  
 Vauxhall 13 36 0020  
 Vauxhall 23 35 4435

**Application info**

Opel Insignia A (07/08-03/17)  
 Vauxhall Insigna Mk I A (07/08-05/17)

Saab 9-5 (YS3G) (01/10-01/12)

**Control arm**

616 050 0017

MCA0692

**Notes**

Control Arm  
 Front Axle Left  
 Lower  
 Sheet Steel  
 with ball joint  
 with rubber mount

Paired article number  
 Required quantity  
 replacement in pairs recommended

616 050 0018 | MCA0693  
 1



**References**

GENERAL MOTORS 90445669  
 GENERAL MOTORS 90576788  
 Opel 3 52 197  
 Vauxhall 3 52 029  
 Vauxhall 53 52 007

GENERAL MOTORS 90497307  
 Opel 3 52 029  
 Opel 53 52 007  
 Vauxhall 3 52 197

**Application info**

Opel Omega B (03/94-12/05)

Vauxhall Omega Mk II (12/93-07/03)



**Control arm** **616 050 0018** **MCA0693**

**Notes**

Control Arm  
 Front Axle Right  
 Lower  
 Sheet Steel  
 with ball joint  
 with rubber mount

Paired article number  
 Required quantity  
 replacement in pairs recommended

616 050 0017 | MCA0692  
 1



**References**

GENERAL MOTORS 90445670  
 GENERAL MOTORS 90576789  
 Opel 3 52 196  
 Vauxhall 3 52 028  
 Vauxhall 53 52 008

GENERAL MOTORS 90497308  
 Opel 3 52 028  
 Opel 53 52 008  
 Vauxhall 3 52 196

**Application info**

Opel Omega B (03/94-12/05)

Vauxhall Omega Mk II (12/93-07/03)

**Control arm** **616 050 0019/HD** **MCA0694HD**

**Notes**

Carbon Neutral  
 Control Arm  
 Front Axle Left  
 Lower  
 Sheet Steel  
 with ball joint  
 with rubber mount

Paired article number  
 Replace in pairs only  
 Required quantity  
 reinforced version

616 050 0020/HD | MCA0695HD  
 1



**References**

Chevrolet 24428208  
 Chevrolet 90498735  
 GENERAL MOTORS 24454477  
 Opel 03 52 037  
 Opel 53 52 016  
 Vauxhall 03 52 037  
 Vauxhall 53 52 016

Chevrolet 24454477  
 GENERAL MOTORS 24428208  
 GENERAL MOTORS 90498735  
 Opel 3 52 037  
 Opel 53 52 029  
 Vauxhall 3 52 037  
 Vauxhall 53 52 029

**Application info**

Chevrolet Zafira (F75) (02/99-12/12)  
 Opel Astra H / Zafira B (01/04-05/19)  
 Opel Meriva B (06/10-03/17)  
 Vauxhall Astra Mk V (01/04--)  
 Vauxhall Meriva Mk II B (06/10--)  
 Vauxhall Zafira Mk II (04/05-11/14)

Opel Astra G / Astra Classic / Zafira A (02/98-12/09)  
 Opel Astra J (12/06--)  
 Vauxhall Astra Mk IV (01/93-08/06)  
 Vauxhall Insigna Mk I A (07/08-05/17)  
 Vauxhall Zafira Mk I (11/98-08/05)

**Control arm****616 050 0019****MCA0694****Notes**

Control Arm  
 Front Axle Left  
 Lower  
 Sheet Steel  
 with ball joint  
 with rubber mount  
 Paired article number 616 050 0020 | MCA0695  
 Required quantity 1

Paired article number 616 050 0020 | MCA0695  
 Required quantity 1  
 replacement in pairs recommended

**References**

Chevrolet 24428208  
 Chevrolet 90498735  
 GENERAL MOTORS 24454477  
 Opel 03 52 037  
 Opel 53 52 016  
 Vauxhall 03 52 037  
 Vauxhall 53 52 016

Chevrolet 24454477  
 GENERAL MOTORS 24428208  
 GENERAL MOTORS 90498735  
 Opel 3 52 037  
 Opel 53 52 029  
 Vauxhall 3 52 037  
 Vauxhall 53 52 029

**Application info**

Chevrolet Zafira (F75) (02/99-12/12)  
 Opel Astra H / Zafira B (01/04-05/19)  
 Opel Meriva B (06/10-03/17)  
 Vauxhall Astra Mk V (01/04--)  
 Vauxhall Meriva Mk II B (06/10--)  
 Vauxhall Zafira Mk II (04/05-11/14)

Opel Astra G / Astra Classic / Zafira A (02/98-12/09)  
 Opel Astra J (12/06--)  
 Vauxhall Astra Mk IV (01/93-08/06)  
 Vauxhall Insigna Mk I A (07/08-05/17)  
 Vauxhall Zafira Mk I (11/98-08/05)

**Control arm**

616 050 0020

MCA0695

**Notes**

Control Arm  
 Front Axle Right  
 Lower  
 Sheet Steel  
 with ball joint  
 with rubber mount

Paired article number 616 050 0019 | MCA0694  
 Required quantity 1  
 replacement in pairs recommended



**References**

Chevrolet 24428209  
 Chevrolet 90498736  
 GENERAL MOTORS 24454478  
 Opel 03 52 038  
 Opel 53 52 017  
 Vauxhall 03 52 038  
 Vauxhall 53 52 017

Chevrolet 24454478  
 GENERAL MOTORS 24428209  
 GENERAL MOTORS 90498736  
 Opel 3 52 038  
 Opel 53 52 030  
 Vauxhall 3 52 038  
 Vauxhall 53 52 030

**Application info**

Chevrolet Zafira (F75) (02/99-12/12)  
 Opel Astra H / Zafira B (01/04-05/19)  
 Opel Meriva B (06/10-03/17)  
 Vauxhall Astra Mk V (01/04--)  
 Vauxhall Meriva Mk II B (06/10--)  
 Vauxhall Zafira Mk II (04/05-11/14)

Opel Astra G / Astra Classic / Zafira A (02/98-12/09)  
 Opel Astra J (12/06--)  
 Vauxhall Astra Mk IV (01/93-08/06)  
 Vauxhall Insigna Mk I A (07/08-05/17)  
 Vauxhall Zafira Mk I (11/98-08/05)

**Control arm**

616 050 0020/HD

MCA0695HD

**Notes**

Carbon Neutral  
Control Arm  
Front Axle Right  
Lower  
Sheet Steel  
with ball joint  
with rubber mount

Paired article number 616 050 0019/HD | MCA0694HD  
Replace in pairs only  
Required quantity 1  
reinforced version



**References**

- Chevrolet 24428209
- Chevrolet 90498736
- GENERAL MOTORS 24454478
- Opel 03 52 038
- Opel 53 52 017
- Vauxhall 03 52 038
- Vauxhall 53 52 017
- Chevrolet 24454478
- GENERAL MOTORS 24428209
- GENERAL MOTORS 90498736
- Opel 3 52 038
- Opel 53 52 030
- Vauxhall 3 52 038
- Vauxhall 53 52 030

**Application info**

- Chevrolet Zafira (F75) (02/99-12/12)
- Opel Astra H / Zafira B (01/04-05/19)
- Opel Meriva B (06/10-03/17)
- Vauxhall Astra Mk V (01/04--)
- Vauxhall Meriva Mk II B (06/10--)
- Vauxhall Zafira Mk II (04/05-11/14)
- Opel Astra G / Astra Classic / Zafira A (02/98-12/09)
- Opel Astra J (12/06--)
- Vauxhall Astra Mk IV (01/93-08/06)
- Vauxhall Insignia Mk I A (07/08-05/17)
- Vauxhall Zafira Mk I (11/98-08/05)

**Control arm**

616 050 0021

MCA0696

**Notes**

Control Arm  
Front Axle Left  
Lower  
Sheet Steel  
with ball joint  
with rubber mount

Paired article number 616 050 0022 | MCA0697  
Required quantity 1  
replacement in pairs recommended



**References**

GENERAL MOTORS 13279533  
 Opel 03 52 088  
 Opel 53 52 027  
 Vauxhall 53 52 027

GENERAL MOTORS 93388568  
 Opel 3 52 088  
 Vauxhall 3 52 088

**Application info**

Opel Meriva A (05/03-05/10)

Vauxhall Meriva Mk I A (01/03-06/10)

**Control arm**

616 050 0022

MCA0697

**Notes**

Control Arm  
 Front Axle Right  
 Lower  
 Sheet Steel  
 with ball joint  
 with rubber mount  
 Paired article number 616 050 0021 | MCA0696  
 Required quantity 1

Paired article number  
 Required quantity  
 replacement in pairs recommended



**References**

GENERAL MOTORS 13279534  
 Opel 03 52 090  
 Opel 53 52 028  
 Vauxhall 53 52 028

GENERAL MOTORS 93388569  
 Opel 3 52 090  
 Vauxhall 3 52 090

**Application info**

Opel Meriva A (05/03-05/10)

Vauxhall Meriva Mk I A (01/03-06/10)

**Control arm**

616 050 0025

MCA0698

**Notes**

Control Arm  
 Front Axle Left  
 Front Axle Right  
 Lower  
 Steel  
 with rubber mount

Required quantity  
 replacement in pairs recommended



**References**

GENERAL MOTORS 9208987

Opel 47 05 172

Suzuki 45200-75F00

Suzuki 45200-75F21

Vauxhall 47 08 233

GENERAL MOTORS 9217259

Opel 47 08 233

Suzuki 45200-75F20

Vauxhall 47 05 172

**Application info**

Opel Agila A (09/00-12/07)

Suzuki Wagon R+ II (MM) (05/00--)

Suzuki Wagon R+ I (EM) (10/97-10/00)

Vauxhall Agila Mk I (02/00-03/08)

**Control arm****616 050 0026****MCA0699****Notes**

Control Arm  
 Front Axle Left  
 Front Axle Right  
 Lower  
 Steel  
 with rubber mount

Length [mm]

290

Required quantity

2

replacement in pairs recommended

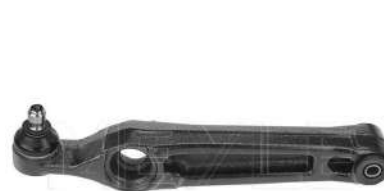
**References**

GENERAL MOTORS 9210270

GENERAL MOTORS 9214826

Opel 47 06 665

Subaru 4520085E00

Suzuki 45200-84E00

Vauxhall 47 05 742

Vauxhall 47 07 280

GENERAL MOTORS 9212530

Opel 47 05 742

Opel 47 07 280

Suzuki 45200-83E00

Suzuki 45200-85E00

Vauxhall 47 06 665

**Application info**

Opel Agila A (09/00-12/07)

Suzuki Ignis II (MH) (08/03--)

Vauxhall Agila Mk I (02/00-03/08)

Subaru Justy III (G3X) (09/03--)

Suzuki Wagon R+ II (MM) (05/00--)

## Control arm

616 050 0028

MCA0700

## Notes

Control Arm  
Front Axle Right  
Lower  
Sheet Steel  
with ball joint  
with rubber mount

Paired article number

616 050 0029 | MCA0701

Required quantity

1

replacement in pairs recommended



## References

Alfa Romeo 51783056

Alfa Romeo 51892273

Alfa Romeo 51895366

Alfa Romeo 55703627

Citroën 3521.S6

Citroën 3521.V5

Fiat 51783056

Fiat 51839039

Fiat 51874461

Fiat 51892273

Fiat 51895366

Fiat 55703627

GENERAL MOTORS 13426553

GENERAL MOTORS 55703231

Opel 3 52 543

Opel 53 52 038

Peugeot 16 109 421 80

Peugeot 16 180 674 80

Peugeot 3521.S6

Peugeot 3521.V5

Vauxhall 53 52 038

## Application info

ABARTH Grande Punto (12/07-12/12)

ABARTH Punto III (03/12--)

Alfa Romeo Mito (08/08--)

Citroën Nemo (02/08--)

Fiat Fiorino Nuovo (225) (01/07--)

Fiat Grande Punto (06/05--)

Fiat Linea (10/06--)

Fiat Punto Evo (07/08--)

Fiat Punto III (01/12--)

Fiat Qubo (02/08--)

Opel Adam (10/12-02/19)

Opel Corsa D (07/06-08/14)

Opel Corsa E (09/14--)

Peugeot Bipper (02/08--)

Vauxhall Adam (10/12-04/19)

Vauxhall Combo Mk III (07/06--)

Vauxhall Corsa Mk III (07/06-08/14)

Vauxhall Corsa Mk IV (08/14--)

## Control arm

616 050 0029

MCA0701

## Notes

Control Arm  
Front Axle Left  
Lower  
Sheet Steel  
with ball joint  
with rubber mount

Paired article number

616 050 0028 | MCA0700

Required quantity

1

replacement in pairs recommended



## References

Alfa Romeo 51892272

Alfa Romeo 55703629

Citroën 3520Y4

Fiat 51839040

Fiat 51892272

Fiat 55703629

GENERAL MOTORS 55703230

Opel 53 52 039

Peugeot 16 180 675 80

Peugeot 3520.W3

Alfa Romeo 51895367

Citroën 3520.W3

Fiat 51783057

Fiat 51874462

Fiat 51895367

GENERAL MOTORS 13426552

Opel 3 52 542

Peugeot 16 109 420 80

Peugeot 3520 Y4

Vauxhall 53 52 039

## Application info

ABARTH Grande Punto (12/07-12/12)

Alfa Romeo Mito (08/08--)

Fiat Fiorino Nuovo (225) (01/07--)

Fiat Linea (10/06--)

Fiat Punto III (01/12--)

Opel Adam (10/12-02/19)

Opel Corsa E (09/14--)

Vauxhall Adam (10/12-04/19)

Vauxhall Corsa Mk III (07/06-08/14)

ABARTH Punto III (03/12--)

Citroën Nemo (02/08--)

Fiat Grande Punto (06/05--)

Fiat Punto Evo (07/08--)

Fiat Qubo (02/08--)



Opel Corsa D (07/06-08/14)

Peugeot Bipper (02/08--)

Vauxhall Combo Mk III (07/06--)

Vauxhall Corsa Mk IV (08/14--)



Control arm		616 050 0031	MCA0703																		
<p><b>Notes</b></p> <p>Control Arm Front Axle Right Sheet Steel with ball joint with rubber mount</p> <p>Paired article number 616 050 0032   MCA0704 Required quantity 1 Thread Size M12x1,5 replacement in pairs recommended</p>																					
<p><b>References</b></p> <table border="0"> <tr> <td>Chevrolet 20946157</td> <td>Chevrolet 25995129</td> </tr> <tr> <td>Chevrolet 95248456</td> <td>Chevrolet 96626236</td> </tr> <tr> <td>Chevrolet 96810754</td> <td>Chevrolet 96819162</td> </tr> <tr> <td>GENERAL MOTORS 20946157</td> <td>GENERAL MOTORS 25995129</td> </tr> <tr> <td>GENERAL MOTORS 96626236</td> <td>GENERAL MOTORS 96819162</td> </tr> <tr> <td>Opel 48 02 540</td> <td>Opel 48 06 301</td> </tr> <tr> <td>Opel 48 12 870</td> <td>Opel 48 17 778</td> </tr> <tr> <td>Vauxhall 48 02 540</td> <td>Vauxhall 48 06 301</td> </tr> <tr> <td>Vauxhall 48 12 870</td> <td>Vauxhall 48 17 778</td> </tr> </table>				Chevrolet 20946157	Chevrolet 25995129	Chevrolet 95248456	Chevrolet 96626236	Chevrolet 96810754	Chevrolet 96819162	GENERAL MOTORS 20946157	GENERAL MOTORS 25995129	GENERAL MOTORS 96626236	GENERAL MOTORS 96819162	Opel 48 02 540	Opel 48 06 301	Opel 48 12 870	Opel 48 17 778	Vauxhall 48 02 540	Vauxhall 48 06 301	Vauxhall 48 12 870	Vauxhall 48 17 778
Chevrolet 20946157	Chevrolet 25995129																				
Chevrolet 95248456	Chevrolet 96626236																				
Chevrolet 96810754	Chevrolet 96819162																				
GENERAL MOTORS 20946157	GENERAL MOTORS 25995129																				
GENERAL MOTORS 96626236	GENERAL MOTORS 96819162																				
Opel 48 02 540	Opel 48 06 301																				
Opel 48 12 870	Opel 48 17 778																				
Vauxhall 48 02 540	Vauxhall 48 06 301																				
Vauxhall 48 12 870	Vauxhall 48 17 778																				
<p><b>Application info</b></p> <table border="0"> <tr> <td>Chevrolet Captiva I (06/06--)</td> <td>Opel Antara (05/06--)</td> </tr> <tr> <td>Vauxhall Antara (08/06--)</td> <td></td> </tr> </table>				Chevrolet Captiva I (06/06--)	Opel Antara (05/06--)	Vauxhall Antara (08/06--)															
Chevrolet Captiva I (06/06--)	Opel Antara (05/06--)																				
Vauxhall Antara (08/06--)																					
Control arm		616 050 0032	MCA0704																		
<p><b>Notes</b></p> <p>Control Arm Front Axle Left Sheet Steel with ball joint with rubber mount</p> <p>Paired article number 616 050 0031   MCA0703 Required quantity 1 Thread Size M12x1,75 replacement in pairs recommended</p>																					

**References**

- |                         |                         |
|-------------------------|-------------------------|
| Chevrolet 20946158      | Chevrolet 95248455      |
| Chevrolet 96626235      | Chevrolet 96810753      |
| Chevrolet 96819161      | GENERAL MOTORS 20946158 |
| GENERAL MOTORS 25995128 | GENERAL MOTORS 96626235 |
| GENERAL MOTORS 96819161 | Opel 47 17 777          |
| Opel 48 02 541          | Opel 48 06 300          |
| Opel 48 10 831          | Opel 48 17 777          |
| Vauxhall 47 17 777      | Vauxhall 48 02 541      |
| Vauxhall 48 06 300      | Vauxhall 48 10 831      |

**Application info**

- |                               |                       |
|-------------------------------|-----------------------|
| Chevrolet Captiva I (06/06--) | Opel Antara (05/06--) |
| Vauxhall Antara (08/06--)     |                       |

**Control arm**

616 050 0033

MCA0705

**Notes**

Aluminium  
Control Arm  
Front Axle Right  
with accessories  
with rubber mount  
Paired article number  
616 050 0034 | MCA0706  
Required quantity  
1  
replacement in pairs recommended





**References**

- |                         |                         |
|-------------------------|-------------------------|
| Chevrolet 13272606      | Chevrolet 13313750      |
| GENERAL MOTORS 13321339 | GENERAL MOTORS 13334023 |
| GENERAL MOTORS 13401130 | GENERAL MOTORS 13401132 |
| GENERAL MOTORS 13463245 | Opel 03 52 115          |
| Opel 03 52 493          | Opel 3 52 115           |
| Opel 3 52 493           | Opel 3 52 531           |
| Opel 3 52 548           | Vauxhall 3 52 115       |
| Vauxhall 3 52 493       |                         |

**Application info**

- |  |                                  |
|--|----------------------------------|
| Chevrolet Cruze (J300, J305) (07/00--) | Chevrolet Cruze (J308) (08/12--) |
| Chevrolet Volt (04/11--)               | Opel Ampera (11/11-03/15)        |
| Opel Astra J (12/06--)                 | Vauxhall Ampera (03/12--)        |
| Vauxhall Astra Mk VI (12/09-10/15)     |                                  |

Control arm		616 050 0034	MCA0706
<p><b>Notes</b></p> <p>Aluminium Control Arm Front Axle Left with accessories with rubber mount</p> <p>Paired article number Required quantity replacement in pairs recommended</p>			
<p><b>References</b></p> <p>Chevrolet 13272605 Chevrolet 13401131 GENERAL MOTORS 13334022 GENERAL MOTORS 13463244 Opel 03 52 492 Opel 3 52 492 Opel 3 52 547 Vauxhall 3 52 492</p>		<p>Chevrolet 13313749 GENERAL MOTORS 13321338 GENERAL MOTORS 13401129 Opel 03 52 110 Opel 3 52 110 Opel 3 52 530 Vauxhall 3 52 110</p>	
<p><b>Application info</b></p> <p>Chevrolet Cruze (J300, J305) (07/00--) Chevrolet Volt (04/11--) Opel Astra J (12/06--) Vauxhall Astra Mk VI (12/09-10/15)</p>		<p>Chevrolet Cruze (J308) (08/12--) Opel Ampera (11/11-03/15) Vauxhall Ampera (03/12--)</p>	
Control arm		616 050 0037	MCA1345
<p><b>Notes</b></p> <p>Control Arm Front Axle Right Sheet Steel with ball joint with rubber mount</p> <p>Paired article number Required quantity replacement in pairs recommended</p>			

**References**

- |                         |                         |
|-------------------------|-------------------------|
| Chevrolet 94540669      | Chevrolet 94540670      |
| Chevrolet 95025704      | Chevrolet 95025705      |
| GENERAL MOTORS 94540669 | GENERAL MOTORS 94540670 |
| GENERAL MOTORS 95025704 | GENERAL MOTORS 95025705 |
| Opel 3 52 522           | Opel 3 52 523           |
| Opel 3 52 552           | Opel 3 52 553           |
| Opel 94540670           | Opel 95025704           |
| Vauxhall 3 52 523       | Vauxhall 3 52 552       |
| Vauxhall 94540669       | Vauxhall 94540670       |

**Application info**

- |                            |                        |
|----------------------------|------------------------|
| Chevrolet Trax (12/12--)   | Opel Mokka A (06/12--) |
| Vauxhall Mokka A (06/12--) |                        |

**Control arm**

**616 050 0038 MCA1346**

**Notes**

Control Arm  
 Front Axle Left  
 Sheet Steel  
 with ball joint  
 with rubber mount  
 Paired article number 616 050 0037 | MCA1345  
 Required quantity 1  
 replacement in pairs recommended





**References**

- |                         |                         |
|-------------------------|-------------------------|
| Chevrolet 94540668      | Chevrolet 95025706      |
| GENERAL MOTORS 94540668 | GENERAL MOTORS 95025706 |
| Opel 3 52 524           | Opel 3 52 551           |
| Opel 94540668           | Opel 95025706           |
| Vauxhall 3 52 524       | Vauxhall 94540668       |

**Application info**

- |                            |                        |
|----------------------------|------------------------|
| Chevrolet Trax (12/12--)   | Opel Mokka A (06/12--) |
| Vauxhall Mokka A (06/12--) |                        |

Control arm		616 050 0040	MCA1243
<p><b>Notes</b></p> <p>Rear Axle Right Semi-Trailing Arm Steel Upper</p> <p>Paired article number 616 050 0041   MCA1244 Required quantity 1 replacement in pairs recommended</p>			
<p><b>References</b></p> <p>Chevrolet 13318345 Opel 13219163 Opel 13318345 Opel 4 23 043 Opel 4 23 071 Saab 13 31 8345 Vauxhall 13219163 Vauxhall 13318345</p>			
<p><b>Application info</b></p> <p>Opel Insignia A (07/08-03/17) Saab 9-5 (YS3G) (01/10-01/12) Vauxhall Insigna Mk I A (07/08-05/17)</p>			
Control arm		616 050 0041	MCA1244
<p><b>Notes</b></p> <p>Rear Axle Left Semi-Trailing Arm Steel Upper outer</p> <p>Paired article number 616 050 0040   MCA1243 Required quantity 1 replacement in pairs recommended</p>			
<p><b>References</b></p> <p>Chevrolet 13318344 Opel 13219162 Opel 13318344 Opel 4 23 042 Opel 4 23 073 Saab 13 31 8344 Vauxhall 13219162 Vauxhall 13318344</p>			
<p><b>Application info</b></p> <p>Opel Insignia A (07/08-03/17) Saab 9-5 (YS3G) (01/10-01/12) Vauxhall Insigna Mk I A (07/08-05/17)</p>			

**Control arm** **616 050 0045** **MCA1328**

**Notes**

Control Arm  
 Front Axle Left  
 Lower  
 Sheet Steel  
 Paired article number 616 050 0046 | MCA1329  
 Required quantity 1  
 replacement in pairs recommended



**References**

Fiat 6000618836	GENERAL MOTORS 93868600
GENERAL MOTORS 95530921	Nissan 54501-00Q1M
Opel 44 22 270	Opel 95530921
Renault 545016850R	Renault 545019956R
Vauxhall 44 22 270	Vauxhall 95 53 0921

**Application info**

Fiat Talento (06/16--)	Nissan NV300 (09/16--)
Nissan Primastar II (X82) (11/21--)	Opel Vivaro B (06/14--)
Renault Trafic III (05/14--)	Vauxhall Vivaro B (05/14--)

**Control arm** **616 050 0046** **MCA1329**

**Notes**

Control Arm  
 Front Axle Right  
 Lower  
 Sheet Steel  
 Paired article number 616 050 0045 | MCA1328  
 Required quantity 1  
 replacement in pairs recommended



**References**

Fiat 6000618835	GENERAL MOTORS 93868599
GENERAL MOTORS 95530938	Nissan 54500-00Q2B
Opel 44 22 269	Opel 95530938
Renault 545002914R	Renault 545006069R
Vauxhall 44 22 269	Vauxhall 95 53 0938

**Application info**

Fiat Talento (06/16--)  
 Nissan Primastar II (X82) (11/21--)  
 Renault Trafic III (05/14--)

Nissan NV300 (09/16--)  
 Opel Vivaro B (06/14--)  
 Vauxhall Vivaro B (05/14--)

**Control arm**

616 050 0049/HD

MCA1353HD

**Notes**

Carbon Neutral  
 Control Arm  
 Front Axle Left  
 Lower  
 Sheet Steel

Paired article number 616 050 0050/HD | MCA1354HD  
 Replace in pairs only  
 Required quantity 1  
 reinforced version



**References**

GENERAL MOTORS 39010110  
 GENERAL MOTORS 39089344  
 Opel 39021472  
 Vauxhall 39010110  
 Vauxhall 39089344

GENERAL MOTORS 39021472  
 Opel 39010110  
 Opel 39089344  
 Vauxhall 39021472

**Application info**

Opel Astra K (06/15--)

Vauxhall Astra Mk VII (07/15--)

**Control arm**

616 050 0050/HD

MCA1354HD

**Notes**

Carbon Neutral  
 Control Arm  
 Front Axle Right  
 Lower  
 Sheet Steel

Paired article number 616 050 0049/HD | MCA1353HD  
 Replace in pairs only  
 Required quantity 1  
 reinforced version



**References**

GENERAL MOTORS 39001026  
 GENERAL MOTORS 39089345  
 Opel 39021473  
 Vauxhall 39 08 9345  
 Vauxhall 39021473

GENERAL MOTORS 39021473  
 Opel 39001026  
 Opel 39089345  
 Vauxhall 39001026

**Application info**

Opel Astra K (06/15--)

Vauxhall Astra Mk VII (07/15--)

**Control arm****616 050 0070/HD****MCA1118HD****Notes**

Aluminium  
 Carbon Neutral  
 Control Arm  
 Front Axle Right  
 Lower  
 outer  
 with rubber mount  
 Paired article number  
 616 050 0071/HD | MCA1119HD

Replace in pairs only  
 Required quantity  
 reinforced version

1

**References**

GENERAL MOTORS 13371817  
 Opel 3 52 510  
 Vauxhall 13371817



GENERAL MOTORS 13461921  
 Opel 3 52 550  
 Vauxhall 13461921



**Application info**

Opel Zafira C (Tourer) (10/11--)

Vauxhall Zafira Mk III (10/11-08/18)



Control arm	616 050 0071/HD	MCA1119HD
<p><b>Notes</b></p> <p>Aluminium Carbon Neutral Control Arm Front Axle Left Lower outer with rubber mount</p> <p>Paired article number Replace in pairs only Required quantity reinforced version</p>		<p>616 050 0070/HD   MCA1118HD</p> <p>1</p>
<p><b>References</b></p> <p>GENERAL MOTORS 13371816    GENERAL MOTORS 13461920            Opel 3 52 509    Opel 3 52 549            Vauxhall 13371816    Vauxhall 13461920</p>		
<p><b>Application info</b></p> <p>Opel Zafira C (Tourer) (10/11--)</p> <p style="text-align: right;">Vauxhall Zafira Mk III (10/11-08/18)</p>		
Control arm	616 050 0072	MCA1294
<p><b>Notes</b></p> <p>Control Arm Front Axle Right Lower Sheet Steel</p> <p>Paired article number Required quantity replacement in pairs recommended</p>		<p>616 050 0073   MCA1295</p> <p>1</p>
<p><b>References</b></p> <p>GENERAL MOTORS 84198833    Opel 84198833            Vauxhall 84 19 8833</p>		
<p><b>Application info</b></p> <p>Opel Insignia B (03/17--)</p> <p style="text-align: right;">Vauxhall Insignia Mk II B (03/17--)</p>		

Control arm		616 050 0073	MCA1295
<b>Notes</b>  Control Arm Front Axle Left Lower Sheet Steel  Paired article number 616 050 0072   MCA1294 Required quantity 1 replacement in pairs recommended			
<b>References</b> GENERAL MOTORS 84198832 Opel 84198832 Vauxhall 84 19 8832			
<b>Application info</b> Opel Insignia B (03/17--) Vauxhall Insignia Mk II B (03/17--)			
Control arm		616 050 0076	MCA1522
<b>Notes</b>  Control Arm Front Axle Right Lower Steel for left-hand drive vehicles for right-hand drive vehicles outer without ball joint  Bore Diameter [mm] 14.1 Length [mm] 320.4 Paired article number 616 050 0077   MCA1523 Required quantity 1 Width [mm] 276.4 replacement in pairs recommended			
<b>References</b> Citroën 98 168 654 80 Citroën 98 463 290 80 Fiat 9831088580 Opel 36 46 247 Opel 98 168 654 80 Opel 98 463 290 80 Peugeot 98 168 654 80 Peugeot 98 463 290 80 Vauxhall 36 46 247 Vauxhall 98 168 654 80 Vauxhall 98 463 290 80			

**Application info**

Citroën Berlingo III (06/18--)

Citroën C4 II / DS4 (02/09--)

Citroën C5 AIRCROSS (11/18--)

Opel Combo E (K9) (06/18--)

Peugeot 3008 II (05/16--)

Peugeot Rifter (09/18--)

Vauxhall Combo Mk IV (06/18--)

Citroën C4 Grand Picasso II (01/13--)

Citroën C4 SPACETOURER / GRAND SPACETOURER  
(04/18--)

Fiat Doblo (510\_, 511\_) (06/22--)

Opel Grandland X (75) (06/17--)

Peugeot 5008 II (12/16--)

Toyota Proace City (10/19--)

Vauxhall Grandland X (75) (06/17--)

**Control arm****616 050 0076/S****MCA1530****Notes**

Control Arm  
 Front Axle Right  
 Lower  
 Steel  
 for left-hand drive vehicles  
 for right-hand drive vehicles  
 outer  
 with ball joint

Bore Diameter [mm]

14.1

Length [mm]

380.1

Paired article number

616 050 0077/S | MCA1531

Required quantity

1

Thread Size

M14x1,5

Width [mm]

276.4

replacement in pairs recommended

**References**

Citroën 98 034 340 80

Citroën 98 463 290 80

GENERAL MOTORS 9816865480

Opel 36 46 247

Peugeot 98 03 434 080

Peugeot 98 463 290 80

Vauxhall 36 46 247

Citroën 98 168 654 80

GENERAL MOTORS 3637430

Opel 36 37 430

Opel 98 168 654 80

Peugeot 98 16 865 480

Vauxhall 36 37 430

Vauxhall 98 168 654 80

**Application info**

Citroën Berlingo III (06/18--)  
Citroën C4 II / DS4 (02/09--)

Citroën C5 AIRCROSS (11/18--)  
Opel Grandland X (75) (06/17--)  
Peugeot 5008 II (12/16--)  
Vauxhall Grandland X (75) (06/17--)

Citroën C4 Grand Picasso II (01/13--)  
Citroën C4 SPACETOURER / GRAND SPACETOURER  
(04/18--)  
Opel Combo E (K9) (06/18--)  
Peugeot 3008 II (05/16--)  
Vauxhall Combo Mk IV (06/18--)

**Control arm****616 050 0077****MCA1523****Notes**

Control Arm  
Front Axle Left  
Lower  
Steel  
for left-hand drive vehicles  
for right-hand drive vehicles  
outer  
without ball joint

Bore Diameter [mm] 14.1  
Length [mm] 320.4  
Paired article number 616 050 0076 | MCA1522  
Required quantity 1  
Width [mm] 276.4  
replacement in pairs recommended

**References**

Citroën 98 168 655 80  
Fiat 9846329580  
Opel 98 168 655 80  
Peugeot 98 16 865 580  
Vauxhall 36 46 272  
Vauxhall 98 463 295 80

Citroën 98 463 295 80  
Opel 36 46 272  
Opel 98 463 295 80  
Peugeot 98 463 295 80  
Vauxhall 98 168 655 80

**Application info**

Citroën Berlingo III (06/18--)  
Citroën C4 II / DS4 (02/09--)

Citroën C5 AIRCROSS (11/18--)  
Opel Combo E (K9) (06/18--)  
Peugeot 3008 II (05/16--)  
Peugeot Rifter (09/18--)  
Vauxhall Combo Mk IV (06/18--)

Citroën C4 Grand Picasso II (01/13--)  
Citroën C4 SPACETOURER / GRAND SPACETOURER  
(04/18--)  
Fiat Doblo (510\_, 511\_) (06/22--)  
Opel Grandland X (75) (06/17--)  
Peugeot 5008 II (12/16--)  
Toyota Proace City (10/19--)  
Vauxhall Grandland X (75) (06/17--)

## Control arm

616 050 0077/S

MCA1531

## Notes

Control Arm  
 Front Axle Left  
 Lower  
 Steel  
 for left-hand drive vehicles  
 for right-hand drive vehicles  
 outer  
 with ball joint

Length [mm]

380.1

Paired article number

616 050 0076/S | MCA1530

Required quantity

1

Thread Size

M14x1,5

Width [mm]

276.4

replacement in pairs recommended



## References

Citroën 98 034 340 80

Citroën 98 463 295 80

GENERAL MOTORS 9816865580

Opel 36 46 272

Peugeot 98 03 434 080

Peugeot 98 463 295 80

Vauxhall 36 46 272

Citroën 98 168 655 80

GENERAL MOTORS 3637430

Opel 36 37 430

Opel 98 168 655 80

Peugeot 98 16 865 580

Vauxhall 36 37 430

Vauxhall 98 168 655 80

## Application info

Citroën Berlingo III (06/18--)

Citroën C4 II / DS4 (02/09--)

Citroën C5 AIRCROSS (11/18--)

Opel Grandland X (75) (06/17--)

Peugeot 5008 II (12/16--)

Vauxhall Grandland X (75) (06/17--)



Citroën C4 Grand Picasso II (01/13--)



Citroën C4 SPACETOURER / GRAND SPACETOURER  
(04/18--)

Opel Combo E (K9) (06/18--)

Peugeot 3008 II (05/16--)

Vauxhall Combo Mk IV (06/18--)

Control arm		616 050 0210	MCA0707
<p><b>Notes</b></p> <p>Control Arm Front Axle Left Lower Sheet Steel with ball joint with rubber mount</p> <p>Paired article number Required quantity replacement in pairs recommended</p>	<p>616 050 0211   MCA0708</p> <p>1</p>		
<p><b>References</b></p> <p>GENERAL MOTORS 90496039 Opel 53 52 005 Vauxhall 53 52 005</p>			
<p><b>Application info</b></p> <p>Opel Vectra B (09/95-07/04) Vauxhall Vectra Mk I (08/95-07/03)</p>			
Control arm		616 050 0211	MCA0708
<p><b>Notes</b></p> <p>Control Arm Front Axle Right Lower Sheet Steel for vehicles without xenon light with ball joint with rubber mount</p> <p>Paired article number Required quantity replacement in pairs recommended</p>	<p>616 050 0210   MCA0707</p> <p>1</p>		
<p><b>References</b></p> <p>GENERAL MOTORS 90496040 GENERAL MOTORS 9228477 Opel 03 52 030 Opel 3 52 030 Opel 53 52 004 Vauxhall 03 52 030 Vauxhall 3 52 030 Vauxhall 53 52 004</p>			
<p><b>Application info</b></p> <p>Opel Vectra B (09/95-07/04) Vauxhall Vectra Mk I (08/95-07/03)</p>			

Control arm		70-16 035 0002	MCA1588
<b>Notes</b>  Front Rear Axle Left Rear Axle Right Semi-Trailing Arm Steel Pipe Upper  Bore Diameter [mm] 12.2 Length [mm] 274.8 Required quantity 2 replacement in pairs recommended			
<b>References</b> TESLA 1044421-00-G TESLA 1044427-00-C			
<b>Application info</b> TESLA Model 3 (01/17--)			
Control arm		70-16 035 0003	MCA1639
<b>Notes</b>  Front Lower Rear Axle Left Rear Axle Right Semi-Trailing Arm Steel Pipe for left-hand drive vehicles for right-hand drive vehicles  Required quantity 2 replacement in pairs recommended			
<b>References</b> TESLA 1044441-00-E TESLA 1044441-00-F TESLA 1044444-00-A TESLA 1044444-00-B TESLA 1288441-99-A			
<b>Application info</b> TESLA Model 3 (01/17--) TESLA Model Y (03/19--)			

DRIVER'S BEST FRIEND

MEYLE

**Control arm**

70-16 050 0005

MCA1661

**Notes**

Aluminium  
Control Arm  
Front  
Front Axle Left  
Front Axle Right  
Lower

Paired article number 70-16 050 0007  
Required quantity 2  
replacement in pairs recommended



**References**

TESLA 1044341-00-C TESLA 1044341-00-D  
TESLA 1044341-99-D TESLA 1188341-00-C  
TESLA 1288341-00-B

**Application info**

TESLA Model 3 (01/17--) TESLA Model Y (03/19--)

**Control arm**

70-16 050 0009/HD

MCA1559HD

**Notes**

Aluminium  
Carbon Neutral  
Control Arm  
Front Axle Left  
Upper  
Paired article number 70-16 050 0010/HD | MCA1560HD

Replace in pairs only  
Required quantity 1  
reinforced version





**References**

TESLA 1044321-00-F TESLA 1044321-00-G  
TESLA 1044321-00-H TESLA 1044321-00-J  
TESLA 1288321-00-A

**Application info**

TESLA Model 3 (01/17--) TESLA Model Y (03/19--)



Control arm		70-16 050 0010/HD	MCA1560HD
<b>Notes</b>  Paired article number Replace in pairs only Required quantity reinforced version		Aluminium Carbon Neutral Control Arm Front Axle Right Upper 70-16 050 0009/HD   MCA1559HD 1	
<b>References</b> TESLA 1044326-00-F TESLA 1044326-00-H TESLA 1288326-00-A TESLA 1044326-00-G TESLA 1044326-00-J			
<b>Application info</b> TESLA Model 3 (01/17--) TESLA Model Y (03/19--)			
Control arm		70-16 050 0012	MCA1598
<b>Notes</b>  Bore Diameter [mm] Length [mm] Required quantity replacement in pairs recommended		Centre Control Arm Rear Axle Left Rear Axle Right Steel Upper 14.2 254.7 2	
<b>References</b> TESLA 1044423-00-G TESLA 1188423-00-A TESLA 1044423-00-H			
<b>Application info</b> TESLA Model 3 (01/17--) TESLA Model Y (03/19--)			

**Control arm** 716 050 0007 MCA0713

**Notes**

Control Arm  
 Front Axle Right  
 Lower  
 Sheet Steel  
 with ball joint  
 with rubber mount

Length [mm] 332  
 Paired article number 716 050 0008 | MCA0714  
 Required quantity 1  
 replacement in pairs recommended



**References**

- |                   |                   |
|-------------------|-------------------|
| Ford 1 073 214    | Ford 1 090 730    |
| Ford 1 138 160    | Ford 1 207 973    |
| Ford 1 212 809    | Ford 1 344 966    |
| Ford 2M51-3042-BA | Ford 2M51-3042-BC |
| Ford 2M51-3042-BD | Ford 2M51-3042-BE |
| Ford 98AG-3042-AJ | Ford 98AG-3042-AK |

**Application info**

Ford Focus I (08/98-11/09)

**Control arm** 716 050 0008 MCA0714

**Notes**

Control Arm  
 Front Axle Left  
 Lower  
 Sheet Steel  
 with ball joint  
 with rubber mount

Length [mm] 332  
 Paired article number 716 050 0007 | MCA0713  
 Required quantity 1  
 replacement in pairs recommended



**References**

Ford 1 073 215	Ford 1 090 738
Ford 1 138 161	Ford 1 207 974
Ford 1 212 810	Ford 1 344 968
Ford 2M51-3051-BA	Ford 2M51-3051-BC
Ford 2M51-3051-BD	Ford 2M51-3051-BE
Ford 98AG-3051-AJ	Ford 98AG-3051-AK

**Application info**

Ford Focus I (08/98-11/09)

**Control arm**

716 050 0009

MCA0715

**Notes**

Control Arm  
 Front Axle Right  
 Lower  
 Sheet Steel  
 with ball joint  
 with rubber mount  
 Cone Size [mm] 18  
 Length [mm] 296.6  
 Paired article number 716 050 0010 | MCA0716  
 Required quantity 1  
 replacement in pairs recommended





**References**

Ford 1 023 026	Ford 1 030 277
Ford 1 043 159	Ford 1 102 948
Ford 1 141 293	Ford 1 710 790
Ford 6 790 117	Ford 6 870 550
Ford 6 954 470	Ford 93BB-3042-BA
Ford 93BB-3042-BB	Ford 93BB-3042-BC
Ford 95BG-3042-AA	Ford 97BG-3042-AA
Ford 97BG-3042-CA	Ford ME93BB-3042-AA
Ford YS71-3042-AA	Ford YS71-3042-AB

**Application info**

Ford Mondeo I, II (01/93-09/00)

Control arm		716 050 0010	MCA0716														
<p><b>Notes</b></p> <p>Control Arm Front Axle Left Lower Sheet Steel with ball joint with rubber mount</p> <p>Cone Size [mm] 18 Length [mm] 296.6 Paired article number 716 050 0009   MCA0715 Required quantity 1 replacement in pairs recommended</p>																	
<p><b>References</b></p> <table border="0"> <tr> <td>Ford 1 030 278</td> <td>Ford 1 043 158</td> </tr> <tr> <td>Ford 1 102 949</td> <td>Ford 1 141 294</td> </tr> <tr> <td>Ford 1 710 794</td> <td>Ford 6 870 551</td> </tr> <tr> <td>Ford 6 954 471</td> <td>Ford 93BB-3051-BB</td> </tr> <tr> <td>Ford 93BB-3051-BC</td> <td>Ford 97BG3051AA</td> </tr> <tr> <td>Ford 97BG3051CA</td> <td>Ford ME93BB-3051-AA</td> </tr> <tr> <td>Ford YS71-3051-AA</td> <td>Ford YS71-3051-AB</td> </tr> </table>				Ford 1 030 278	Ford 1 043 158	Ford 1 102 949	Ford 1 141 294	Ford 1 710 794	Ford 6 870 551	Ford 6 954 471	Ford 93BB-3051-BB	Ford 93BB-3051-BC	Ford 97BG3051AA	Ford 97BG3051CA	Ford ME93BB-3051-AA	Ford YS71-3051-AA	Ford YS71-3051-AB
Ford 1 030 278	Ford 1 043 158																
Ford 1 102 949	Ford 1 141 294																
Ford 1 710 794	Ford 6 870 551																
Ford 6 954 471	Ford 93BB-3051-BB																
Ford 93BB-3051-BC	Ford 97BG3051AA																
Ford 97BG3051CA	Ford ME93BB-3051-AA																
Ford YS71-3051-AA	Ford YS71-3051-AB																
<p><b>Application info</b></p> <p>Ford Mondeo I, II (01/93-09/00)</p>																	
Control arm		716 050 0015	MCA1002														
<p><b>Notes</b></p> <p>Control Arm Front Axle Left Sheet Steel with ball joint with rubber mount</p> <p>Paired article number 716 050 0016   MCA1003 Required quantity 1 replacement in pairs recommended</p>																	

**References**

- |                     |                     |
|---------------------|---------------------|
| Ford 1 702 983      | Ford 1 709 466      |
| Ford 1 742 266      | Ford 1 857 346      |
| Ford 1 865 175      | Ford 1 865 176      |
| Ford 1 866 073      | Ford 2 173 541      |
| Ford 2 176 249      | Ford AV61-3A424-LB  |
| Ford AV61-3A424-LC  | Ford BV61-3A424-AAB |
| Ford BV61-3A424-AAC | Ford BV61-3A424-AAD |
| Ford BV61-3A424-BAB | Ford BV61-3A424-BAC |
| Ford F1F1-3A424-AAA | Ford F1F1-3A424-AAB |

**Application info**

- |                         |                          |
|-------------------------|--------------------------|
| Ford C-Max II (04/10--) | Ford Focus III (07/10--) |
|-------------------------|--------------------------|

**Control arm**

716 050 0015/HD

MCA1002HD

**Notes**

Carbon Neutral  
Control Arm  
Front Axle Left  
Sheet Steel  
with ball joint  
with rubber mount

Paired article number  
Replace in pairs only  
Required quantity  
reinforced version

716 050 0016/HD | MCA1003HD

1



**References**

- |                     |                     |
|---------------------|---------------------|
| Ford 1 702 983      | Ford 1 709 466      |
| Ford 1 742 266      | Ford 1 857 346      |
| Ford 1 865 175      | Ford 1 865 176      |
| Ford 1 866 073      | Ford 2 173 541      |
| Ford 2 176 249      | Ford AV61-3A424-LB  |
| Ford AV61-3A424-LC  | Ford BV61-3A424-AAB |
| Ford BV61-3A424-AAC | Ford BV61-3A424-AAD |
| Ford BV61-3A424-BAB | Ford BV61-3A424-BAC |
| Ford F1F1-3A424-AAA | Ford F1F1-3A424-AAB |

**Application info**

- |                         |                          |
|-------------------------|--------------------------|
| Ford C-Max II (04/10--) | Ford Focus III (07/10--) |
|-------------------------|--------------------------|

**Control arm**

716 050 0015/S

MCA1101

**Notes**

Control Arm  
Front Axle Left  
Sheet Steel  
with ball joint  
with fastening material  
with rubber mount

Paired article number 716 050 0016/S | MCA1102  
Required quantity 1  
replacement in pairs recommended



**References**

- |                     |                     |
|---------------------|---------------------|
| Ford 1 702 983      | Ford 1 709 466      |
| Ford 1 742 266      | Ford 1 857 346      |
| Ford 1 865 175      | Ford 1 865 176      |
| Ford 1 866 073      | Ford 2 173 541      |
| Ford 2 176 249      | Ford AV61-3A424-LB  |
| Ford AV61-3A424-LC  | Ford BV61-3A424-AAB |
| Ford BV61-3A424-AAC | Ford BV61-3A424-AAD |
| Ford BV61-3A424-BAB | Ford BV61-3A424-BAC |
| Ford F1F1-3A424-AAA | Ford F1F1-3A424-AAB |

**Application info**

Ford C-Max II (04/10--)

Ford Focus III (07/10--)

**Control arm**

716 050 0016

MCA1003

**Notes**

Control Arm  
Front Axle Right  
Sheet Steel  
with ball joint  
with rubber mount

Paired article number 716 050 0015 | MCA1002  
Required quantity 1  
replacement in pairs recommended



**References**

Ford 1 702 970	Ford 1 709 457
Ford 1 742 265	Ford 1 857 345
Ford 1 865 168	Ford 1 865 173
Ford 1 866 068	Ford 2 172 992
Ford 2 173 539	Ford AV61-3A423-LB
Ford AV61-3A423-LC	Ford BV61-3A423-AAB
Ford BV61-3A423-AAC	Ford BV61-3A423-AAD
Ford BV61-3A423-BAB	Ford BV61-3A423-BAC
Ford F1F1-3A423-AAA	Ford F1F1-3A423-AAB

**Application info**

Ford C-Max II (04/10--)	Ford Focus III (07/10--)
-------------------------	--------------------------

**Control arm**

716 050 0016/HD MCA1003HD

**Notes**

Carbon Neutral  
Control Arm  
Front Axle Right  
Sheet Steel  
with ball joint  
with rubber mount

Paired article number  
Replace in pairs only  
Required quantity  
reinforced version

716 050 0015/HD | MCA1002HD

1





**References**

Ford 1 702 970	Ford 1 709 457
Ford 1 742 265	Ford 1 857 345
Ford 1 865 168	Ford 1 865 173
Ford 1 866 068	Ford 2 172 992
Ford 2 173 539	Ford AV61-3A423-LB
Ford AV61-3A423-LC	Ford BV61-3A423-AAB
Ford BV61-3A423-AAC	Ford BV61-3A423-AAD
Ford BV61-3A423-BAB	Ford BV61-3A423-BAC
Ford F1F1-3A423-AAA	Ford F1F1-3A423-AAB

**Application info**

Ford C-Max II (04/10--)	Ford Focus III (07/10--)
-------------------------	--------------------------

Control arm		716 050 0016/S	MCA1102
<p><b>Notes</b></p> <p>Control Arm Front Axle Right Sheet Steel with ball joint with fastening material with rubber mount</p> <p>Paired article number Required quantity replacement in pairs recommended</p>			
<p><b>References</b></p> <p>Ford 1 702 970 Ford 1 742 265 Ford 1 865 168 Ford 1 866 068 Ford 2 173 539 Ford AV61-3A423-LC Ford BV61-3A423-AAC Ford BV61-3A423-BAB Ford F1F1-3A423-AAA</p>		<p>Ford 1 709 457 Ford 1 857 345 Ford 1 865 173 Ford 2 172 992 Ford AV61-3A423-LB Ford BV61-3A423-AAB Ford BV61-3A423-AAD Ford BV61-3A423-BAC Ford F1F1-3A423-AAB</p>	
<p><b>Application info</b></p> <p>Ford C-Max II (04/10--)</p>		<p>Ford Focus III (07/10--)</p>	
Control arm		716 050 0019	MCA0719
<p><b>Notes</b></p> <p>Front Lower Rear Axle Left Rear Axle Right Semi-Trailing Arm Sheet Steel with rubber mount</p> <p>Length [mm] Required quantity replacement in pairs recommended</p>			



**References**

Ford 1 377 449	Ford 1 381 443
Ford 1 387 628	Ford 1 426 770
Ford 6G91-5K743-XAA	Ford 6G91-5K743-XAB
Ford 6G91-5K743-XAC	Ford 6G91-5K743-XAD
Volvo 30736864	Volvo 30760069
Volvo 31262127	Volvo 31262930
Volvo 31262931	

**Application info**

Ford Galaxy II (05/06-06/15)	Ford Mondeo IV (03/07-01/15)
Ford S-Max I (05/06-12/14)	Volvo S60 II / V60 (04/10--)
Volvo S80 II (03/06-12/16)	Volvo V70 III (04/07--)
Volvo XC70 II (04/07-12/16)	

**Control arm**

716 050 0021

MCA0720

**Notes**

Control Arm  
Front Axle Right  
Lower  
Sheet Steel  
with rubber mount  
716 050 0022 | MCA0721  
1

Paired article number  
Required quantity  
replacement in pairs recommended

**References**

Ford 1 438 315	Ford 1 438 316
Ford 1 495 666	Ford 1 553 246
Ford 1 735 889	Ford 4 042 022
Ford 4 372 130	Ford 4 540 774
Ford 6C11-3A052-EA	Ford 6C11-3A052-EB
Ford 6C11-3A052-FA	Ford 6C11-3A052-FB
Ford 6C11-3A052-FC	Ford YC15-3A052-AH
Ford YC15-3A052-AL	Ford YC15-3A052-AM

**Application info**

Ford Transit '00 (01/00-05/06)	Ford Transit '06 (04/06-12/14)
--------------------------------	--------------------------------

**Control arm**

716 050 0022

MCA0721

**Notes**

Control Arm  
 Front Axle Left  
 Lower  
 Sheet Steel  
 with rubber mount  
 Paired article number 716 050 0021 | MCA0720  
 Required quantity 1  
 replacement in pairs recommended



**References**

- |                    |                    |
|--------------------|--------------------|
| Ford 1 438 318     | Ford 1 438 350     |
| Ford 1 495 667     | Ford 1 553 251     |
| Ford 1 735 890     | Ford 4 042 023     |
| Ford 4 140 394     | Ford 4 164 521     |
| Ford 4 372 131     | Ford 4 540 775     |
| Ford 6C11-3A053-EA | Ford 6C11-3A053-EB |
| Ford 6C11-3A053-FA | Ford 6C11-3A053-FB |
| Ford 6C11-3A053-FC | Ford YC15-3A053-AH |
| Ford YC15-3A053-AJ | Ford YC15-3A053-AK |
| Ford YC15-3A053-AL | Ford YC15-3A053-AM |

**Application info**

Ford Transit '00 (01/00-05/06) Ford Transit '06 (04/06-12/14)

**Control arm**

716 050 0027

MCA0722

**Notes**

Control Arm  
 Front Axle Right  
 Lower  
 Sheet Steel  
 with ball joint  
 with rubber mount  
 Paired article number 716 050 0028 | MCA0723  
 Required quantity 1  
 replacement in pairs recommended



**References**

- |                   |                   |
|-------------------|-------------------|
| Ford 1 146 130    | Ford 1 207 447    |
| Ford 1 212 807    | Ford 1 214 911    |
| Ford 1 436 097    | Ford 1 436 169    |
| Ford 1 706 970    | Ford 2N11-3042-AE |
| Ford 2N11-3042-AH | Ford 2S61-3042-AD |
| Ford 2S61-3042-AH | Ford 2S61-3042-AJ |
| Ford 2S61-3042-AK | Ford 2S61-3042-DA |
| Mazda DD32-34-300 |                   |

**Application info**

- |                                      |                            |
|--------------------------------------|----------------------------|
| Ford Fiesta V / Fusion (11/01-12/14) | Mazda 2 (DY) (02/03-06/07) |
|--------------------------------------|----------------------------|

**Control arm**

**716 050 0028 MCA0723**

**Notes**

Control Arm  
 Front Axle Left  
 Lower  
 Sheet Steel  
 with ball joint  
 with rubber mount

Paired article number 716 050 0027 | MCA0722  
 Required quantity 1  
 replacement in pairs recommended



**References**

- |                   |                   |
|-------------------|-------------------|
| Ford 1 146 131    | Ford 1 207 448    |
| Ford 1 211 757    | Ford 1 212 808    |
| Ford 1 214 912    | Ford 1 436 095    |
| Ford 1 436 170    | Ford 1 706 971    |
| Ford 2N11-3051-AE | Ford 2N11-3051-AG |
| Ford 2N11-3051-AH | Ford 2S61-3051-AD |
| Ford 2S61-3051-AH | Ford 2S61-3051-AJ |
| Ford 2S61-3051-AK | Ford 2S61-3051-DA |
| Mazda DD32-34-350 |                   |

**Application info**

- |                                      |                            |
|--------------------------------------|----------------------------|
| Ford Fiesta V / Fusion (11/01-12/14) | Mazda 2 (DY) (02/03-06/07) |
|--------------------------------------|----------------------------|

**Control arm** **716 050 0029** **MCA0724**

**Notes**

Control Arm  
 Front Axle Right  
 Lower  
 Sheet Steel  
 with rubber mount  
 Paired article number 716 050 0030 | MCA0725  
 Required quantity 1  
 replacement in pairs recommended



**References**

- |                   |                   |
|-------------------|-------------------|
| Ford 1 332 454    | Ford 1 355 048    |
| Ford 2 320 446    | Ford 2T14-3042-BF |
| Ford 2T14-3042-BH | Ford 2T14-3042-BJ |
| Ford 4 366 973    | Ford 4 539 871    |
| Ford 4T16-3042-AA | Ford 4T16-3042-AB |

**Application info**

Ford Tourneo '02 (06/02-12/13) Ford Transit '02 (06/02--)

**Control arm** **716 050 0030** **MCA0725**

**Notes**

Control Arm  
 Front Axle Left  
 Lower  
 Sheet Steel  
 with rubber mount  
 Paired article number 716 050 0029 | MCA0724  
 Required quantity 1  
 replacement in pairs recommended



**References**

- |                   |                   |
|-------------------|-------------------|
| Ford 1 332 455    | Ford 1 355 050    |
| Ford 2 320 448    | Ford 2T14-3051-BF |
| Ford 2T14-3051-BH | Ford 4 366 974    |
| Ford 4T16-3051-AA | Ford 4T16-3051-AB |

**Application info**

Ford Tourneo '02 (06/02-12/13) Ford Transit '02 (06/02--)

## Control arm

716 050 0031/HD

MCA0726HD

## Notes

Carbon Neutral  
Control Arm  
Front Axle Left  
Sheet Steel  
with ball joint  
with rubber mount

Cone Size [mm]

21

Paired article number

716 050 0032/HD | MCA0727HD

Replace in pairs only

Required quantity

1

Thread Size

M14x1,5

reinforced version



## References

Ford 1 420 858

Ford 1 425 976

Ford 1 488 111

Ford 1 488 115

Ford 1 570 285

Ford 1 570 312

Ford 4M51-3A424-AD

Ford 4M51-3A424-AE

Ford 4M51-3A424-AF

Ford 6M5Y-3A424-AA

Ford 6M5Y-3A424-AB

Ford 6M5Y-3A424-AC

Ford (Chanagan) 4M51-3A424-AD

Ford (Chanagan) 4M51-3A424-AE

Ford (Chanagan) 4M51-3A424-AF

Volvo 30760280

Volvo 31201181

Volvo 31262039

Volvo 31277463

Volvo 31290278

## Application info

Ford C-Max I (02/07-09/10)

Ford Focus II (10/03--)

Volvo C30 (09/06-12/13)

Volvo C70 II (03/06-12/13)

Volvo S40 II / V50 (12/03-12/12)

## Control arm

716 050 0032/HD

MCA0727HD

## Notes

Carbon Neutral  
Control Arm  
Front Axle Right  
Sheet Steel  
with ball joint  
with rubber mount

Cone Size [mm]

21

Paired article number

716 050 0031/HD | MCA0726HD

Replace in pairs only

Required quantity

1

Thread Size

M14x1,5

reinforced version



## References

Ford 1 420 795

Ford 1 425 974

Ford 1 488 110

Ford 1 488 114

Ford 1 570 284

Ford 1 570 287

Ford 4M51-3A423-AD

Ford 4M51-3A423-AE

Ford 4M51-3A423-AF

Ford 6M5Y-3A423-AA

Ford 6M5Y-3A423-AB

Ford 6M5Y-3A423-AC

Ford (Chanagan) 4M51-3A423-AD

Ford (Chanagan) 4M51-3A423-AE

Ford (Chanagan) 4M51-3A423-AF

Volvo 30760279

Volvo 31201180

Volvo 31262037

Volvo 31277462

Volvo 31290279

## Application info

Ford C-Max I (02/07-09/10)

Ford Focus II (10/03--)

Volvo C30 (09/06-12/13)

Volvo C70 II (03/06-12/13)

Volvo S40 II / V50 (12/03-12/12)

## Control arm

716 050 0033

MCA0728

## Notes

Control Arm  
Front Axle Left  
Lower  
Sheet Steel  
with ball joint  
with rubber mount

Paired article number

716 050 0034 | MCA0729

Required quantity

1

replacement in pairs recommended



**References**

- |                               |                               |
|-------------------------------|-------------------------------|
| Ford 1 377 848                | Ford 1 385 594                |
| Ford 1 403 410                | Ford 1 419 815                |
| Ford 1 426 876                | Ford 1 435 747                |
| Ford 1 460 693                | Ford 1 466 188                |
| Ford 1 469 026                | Ford 1 507 182                |
| Ford 6G9N-3A053-DG            | Ford 6G9N-3A053-DH            |
| Ford 7G9N-3A053-BA            | Ford 7G9N-3A053-BB            |
| Ford (Chanagan) 7G9N-3A053-BA | Ford (Chanagan) 7G9N-3A053-BB |
| Volvo 31200563                | Volvo 31212782                |
| Volvo 31277343                | Volvo 31317661                |

**Application info**

- |                              |                              |
|------------------------------|------------------------------|
| Ford Galaxy II (05/06-06/15) | Ford Mondeo IV (03/07-01/15) |
| Ford S-Max I (05/06-12/14)   | Volvo S60 II / V60 (04/10--) |
| Volvo S80 II (03/06-12/16)   | Volvo V70 III (04/07--)      |

**Control arm**

716 050 0033/HD

MCA0728HD

**Notes**

Carbon Neutral  
Control Arm  
Front Axle Left  
Lower  
Sheet Steel  
with ball joint  
with rubber mount

- Article number of recommended accessory 514 654 0002  
Paired article number 716 050 0034/HD | MCA0729HD  
Replace in pairs only  
Required quantity 1  
reinforced version



**References**

Ford 1 377 848	Ford 1 385 594
Ford 1 403 410	Ford 1 419 815
Ford 1 426 876	Ford 1 435 747
Ford 1 460 693	Ford 1 466 188
Ford 1 469 026	Ford 1 507 182
Ford 6G9N-3A053-DA	Ford 6G9N-3A053-DB
Ford 6G9N-3A053-DC	Ford 6G9N-3A053-DD
Ford 6G9N-3A053-DE	Ford 6G9N-3A053-DF
Ford 6G9N-3A053-DG	Ford 6G9N-3A053-DH
Ford 7G9N-3A053-BA	Ford 7G9N-3A053-BB
Ford (Chanagan) 7G9N-3A053-BA	Ford (Chanagan) 7G9N-3A053-BB
Volvo 31200776	Volvo 31212782
Volvo 31277343	Volvo 31317661

**Application info**

Ford Galaxy II (05/06-06/15)	Ford Mondeo IV (03/07-01/15)
Ford S-Max I (05/06-12/14)	Volvo S60 II / V60 (04/10--)
Volvo S80 II (03/06-12/16)	Volvo V70 III (04/07--)

**Control arm****716 050 0034****MCA0729****Notes**

Control Arm  
 Front Axle Right  
 Lower  
 Sheet Steel  
 with ball joint  
 with rubber mount

Paired article number 716 050 0033 | MCA0728  
 Required quantity 1  
 replacement in pairs recommended

**References**

Ford 1 377 846	Ford 1 385 593
Ford 1 403 408	Ford 1 419 814
Ford 1 426 875	Ford 1 435 745
Ford 1 458 773	Ford 1 466 186
Ford 1 469 024	Ford 1 507 181
Ford 6G9N-3A052-DG	Ford 6G9N-3A052-DH
Ford 7G9N-3A052-BA	Ford 7G9N-3A052-BB
Ford (Chanagan) 7G9N-3A052-BA	Ford (Chanagan) 7G9N-3A052-BB
Volvo 31200775	Volvo 31212781
Volvo 31277344	Volvo 31317662



**Application info**

Ford Galaxy II (05/06-06/15)  
 Ford S-Max I (05/06-12/14)  
 Volvo S80 II (03/06-12/16)

Ford Mondeo IV (03/07-01/15)  
 Volvo S60 II / V60 (04/10--)  
 Volvo V70 III (04/07--)

**Control arm**

716 050 0034/HD

MCA0729HD

**Notes**

Carbon Neutral  
 Control Arm  
 Front Axle Right  
 Lower  
 Sheet Steel  
 with ball joint  
 with rubber mount



Article number of recommended accessories 514 654 0002  
 Paired article number 716 050 0033/HD | MCA0728HD  
 Replace in pairs only  
 Required quantity 1  
 reinforced version

**References**

- |                               |                               |
|-------------------------------|-------------------------------|
| Ford 1 377 846                | Ford 1 385 593                |
| Ford 1 403 408                | Ford 1 419 814                |
| Ford 1 426 875                | Ford 1 435 745                |
| Ford 1 458 773                | Ford 1 466 186                |
| Ford 1 469 024                | Ford 1 507 181                |
| Ford 6G9N-3A052-DA            | Ford 6G9N-3A052-DB            |
| Ford 6G9N-3A052-DC            | Ford 6G9N-3A052-DD            |
| Ford 6G9N-3A052-DE            | Ford 6G9N-3A052-DF            |
| Ford 6G9N-3A052-DG            | Ford 6G9N-3A052-DH            |
| Ford 7G9N-3A052-BA            | Ford 7G9N-3A052-BB            |
| Ford (Chanagan) 7G9N-3A052-BA | Ford (Chanagan) 7G9N-3A052-BB |
| Volvo 31200775                | Volvo 31212781                |
| Volvo 31277344                | Volvo 31317662                |

**Application info**

Ford Galaxy II (05/06-06/15)  
 Ford S-Max I (05/06-12/14)  
 Volvo S80 II (03/06-12/16)

Ford Mondeo IV (03/07-01/15)  
 Volvo S60 II / V60 (04/10--)  
 Volvo V70 III (04/07--)

## Control arm

716 050 0035/HD

MCA0730HD

## Notes

Carbon Neutral  
Control Arm  
Front Axle Right  
Lower  
Sheet Steel  
with ball joint  
with rubber mount

Paired article number 716 050 0036/HD | MCA0731HD  
Replace in pairs only  
Required quantity 1  
Thread Size M14x1,5  
reinforced version



## References

Ford 1 234 371	Ford 1 254 310
Ford 1 305 341	Ford 1 309 148
Ford 1 309 644	Ford 1 328 380
Ford 1 328 670	Ford 1 332 074
Ford 1 348 191	Ford 1 355 149
Ford 1 362 650	Ford 1 477 858
Ford 1 477 864	Ford 1 570 677
Ford 1 570 750	Ford 3M51-3A423-AB
Ford 3M51-3A423-AC	Ford 3M51-3A423-AD
Ford 3M51-3A423-AE	Ford 3M51-3A423-AF
Ford 3M51-3A423-AG	Ford 3M51-3A423-AH
Ford 3M51-3A423-AJ	Ford 4M51-3A423-AA
Ford 4M51-3A423-AB	Ford 4M51-3A423-AC
Ford 4M51-3A423-BA	Ford 4M51-3A423-BB
Ford 6M5Y-3A423-BA	Ford 6M5Y-3A423-BB
Ford (Chanagan) 4M51-3A423-AC	Volvo 30647736
Volvo 30647877	Volvo 30666840
Volvo 30678439	Volvo 30683339
Volvo 30714127	Volvo 30714423
Volvo 30730830	Volvo 30736955
Volvo 30748230	Volvo 31212980
Volvo 31277465	

## Application info

Ford Focus II (10/03--)	Volvo C30 (09/06-12/13)
Volvo C70 II (03/06-12/13)	Volvo S40 II / V50 (12/03-12/12)

## Control arm

716 050 0036/HD

MCA0731HD

## Notes

Carbon Neutral  
Control Arm  
Front Axle Left  
Lower  
Sheet Steel  
with ball joint  
with rubber mount



Cone Size [mm]

18

Paired article number

716 050 0035/HD | MCA0730HD

Replace in pairs only

Required quantity

1

Thread Size

M14x1,5

reinforced version

## References

Ford 1 234 375

Ford 1 254 311

Ford 1 305 342

Ford 1 309 149

Ford 1 309 645

Ford 1 328 381

Ford 1 328 671

Ford 1 332 075

Ford 1 348 192

Ford 1 355 151

Ford 1 362 651

Ford 1 477 860

Ford 1 477 865

Ford 1 570 312

Ford 1 570 678

Ford 1 570 748

Ford 3M51-3A424-AB

Ford 3M51-3A424-AD

Ford 3M51-3A424-AE

Ford 3M51-3A424-AF

Ford 3M51-3A424-AG

Ford 3M51-3A424-AH

Ford 3M51-3A424-AJ

Ford 3M51-3a424-ac

Ford 4M51-3A424-AA

Ford 4M51-3A424-AB

Ford 4M51-3A424-AC

Ford 4M51-3A424-BA

Ford 4M51-3A424-BB

Ford 6M5Y-3A424-AC

Ford 6M5Y-3A424-BA

Ford 6M5Y-3A424-BB

Ford (Chanagan) 4M51-3A424-AC

Volvo 30647737

Volvo 30647876

Volvo 30678438

Volvo 30683340

Volvo 30714126

Volvo 30714422

Volvo 30730829

Volvo 30748231

Volvo 31212979

Volvo 31277464

## Application info

Ford Focus II (10/03--)

Volvo C30 (09/06-12/13)

Volvo C70 II (03/06-12/13)

Volvo S40 II / V50 (12/03-12/12)

## Control arm

716 050 0041

MCA0732

## Notes

Control Arm  
 Lower  
 Rear Axle Left  
 Rear Axle Right  
 Sheet Steel  
 for left-hand drive vehicles  
 for right-hand drive vehicles  
 with accessories  
 with rubber mount

Bore Diameter [mm]

12

Length [mm]

491

Required quantity

2

replacement in pairs recommended



## References

Ford 1 306 767

Ford 1 321 004

Ford 1 333 283

Ford 1 349 910

Ford 1 352 302

Ford 1 357 317

Ford 1 909 108

Ford 3M51-5K652-GB

Ford 3M51-5K652-GD

Ford 4M51-5K652-AA

Ford 4M51-5K652-AB

Ford 4M51-5K652-AC

Ford 4M51-5K652-AD

Ford 4M51-5K652-AF

## Application info

Ford C-Max I (02/07-09/10)

Ford Focus I (08/98-11/09)

Ford Focus II (10/03--)

## Control arm

716 050 0043

MCA0733

## Notes

Control Arm  
 Front Axle Left  
 Sheet Steel  
 with ball joint  
 with rubber mount

Paired article number

716 050 0044 | MCA0734

Required quantity

1

replacement in pairs recommended



**References**

- |                   |                   |
|-------------------|-------------------|
| Ford 1 521 773    | Ford 1 532 433    |
| Ford 1 540 725    | Ford 1 700 810    |
| Ford 1 708 226    | Ford 1 712 697    |
| Ford 1 737 305    | Ford 8V51-3051-BB |
| Ford 8V51-3051-BC | Ford 8V51-3051-BD |
| Ford 8V51-3051-BE | Ford 8V51-3051-BF |
| Ford 8V51-3051-BG | Ford 8V51-3051-BH |

**Application info**

Ford Fiesta VI (06/08--)

**Control arm**

716 050 0044

MCA0734

**Notes**

Control Arm  
 Front Axle Right  
 Sheet Steel  
 with ball joint  
 with rubber mount

Paired article number  
 Required quantity  
 replacement in pairs recommended

716 050 0043 | MCA0733  
 1







**References**



- |                   |                   |
|-------------------|-------------------|
| Ford 1 518 904    | Ford 1 520 778    |
| Ford 1 532 421    | Ford 1 540 724    |
| Ford 1 700 809    | Ford 1 708 222    |
| Ford 1 712 696    | Ford 1 737 309    |
| Ford 8V51-3042-BA | Ford 8V51-3042-BB |
| Ford 8V51-3042-BC | Ford 8V51-3042-BD |
| Ford 8V51-3042-BE | Ford 8V51-3042-BF |
| Ford 8V51-3042-BG | Ford 8V51-3042-BH |

**Application info**

Ford Fiesta VI (06/08--)

Control arm		716 050 0046	MCA0735
<b>Notes</b>  Aluminium Control Arm Front Axle Left with ball joint with rubber mount  Paired article number Required quantity Thread Size replacement in pairs recommended			
<b>References</b> Volvo 31262475 Volvo 31429321		Volvo 31340128	
<b>Application info</b> Volvo S60 II / V60 (04/10--) Volvo V70 III (04/07--)		Volvo S80 II (03/06-12/16)	
Control arm		716 050 0046/HD	MCA0735HD
<b>Notes</b>  Aluminium Carbon Neutral Control Arm Front Axle Left with ball joint with rubber mount  Paired article number Replace in pairs only Required quantity Thread Size reinforced version			
<b>References</b> Volvo 31262475 Volvo 31429321		Volvo 31340128	
<b>Application info</b> Volvo S60 II / V60 (04/10--) Volvo V70 III (04/07--)		Volvo S80 II (03/06-12/16)	

Control arm		716 050 0047	MCA0736
<b>Notes</b>  Aluminium Control Arm Front Axle Right with ball joint with rubber mount  Paired article number Required quantity Thread Size replacement in pairs recommended			
<b>References</b> Volvo 31262473 Volvo 31429320		Volvo 31340127	
<b>Application info</b> Volvo S60 II / V60 (04/10--) Volvo V70 III (04/07--)		Volvo S80 II (03/06-12/16)	
Control arm		716 050 0047/HD	MCA0736HD
<b>Notes</b>  Aluminium Carbon Neutral Control Arm Front Axle Right with ball joint with rubber mount  Paired article number Replace in pairs only Required quantity Thread Size reinforced version			
<b>References</b> Volvo 31262473 Volvo 31429320		Volvo 31340127	
<b>Application info</b> Volvo S60 II / V60 (04/10--) Volvo V70 III (04/07--)		Volvo S80 II (03/06-12/16)	

Control arm		716 050 0048	MCA1357								
<p><b>Notes</b></p> <p>Control Arm Front Axle Right Lower Sheet Steel outer</p> <p>Paired article number 716 050 0049   MCA1358 Required quantity 1 replacement in pairs recommended</p>		 									
<p><b>References</b></p> <table border="0"> <tr> <td>Ford 2 084 192</td> <td>Ford 2 112 616</td> </tr> <tr> <td>Ford 2 201 370</td> <td>Ford 2 337 423</td> </tr> <tr> <td>Ford H1BC-3042-AA</td> <td>Ford H1BC-3042-AD</td> </tr> <tr> <td>Ford H1BC-3042-AE</td> <td>Ford H1BC-3042-AF</td> </tr> </table>				Ford 2 084 192	Ford 2 112 616	Ford 2 201 370	Ford 2 337 423	Ford H1BC-3042-AA	Ford H1BC-3042-AD	Ford H1BC-3042-AE	Ford H1BC-3042-AF
Ford 2 084 192	Ford 2 112 616										
Ford 2 201 370	Ford 2 337 423										
Ford H1BC-3042-AA	Ford H1BC-3042-AD										
Ford H1BC-3042-AE	Ford H1BC-3042-AF										
<p><b>Application info</b></p> <p>Ford Fiesta VII (05/17--)</p>											
Control arm		716 050 0049	MCA1358								
<p><b>Notes</b></p> <p>Control Arm Front Axle Left Lower Sheet Steel outer</p> <p>Paired article number 716 050 0048   MCA1357 Required quantity 1 replacement in pairs recommended</p>		 									
<p><b>References</b></p> <table border="0"> <tr> <td>Ford 2 084 194</td> <td>Ford 2 112 614</td> </tr> <tr> <td>Ford 2 201 372</td> <td>Ford 2 337 412</td> </tr> <tr> <td>Ford H1BC-3051-AA</td> <td>Ford H1BC-3051-AD</td> </tr> <tr> <td>Ford H1BC-3051-AE</td> <td>Ford H1BC-3051-AF</td> </tr> </table>				Ford 2 084 194	Ford 2 112 614	Ford 2 201 372	Ford 2 337 412	Ford H1BC-3051-AA	Ford H1BC-3051-AD	Ford H1BC-3051-AE	Ford H1BC-3051-AF
Ford 2 084 194	Ford 2 112 614										
Ford 2 201 372	Ford 2 337 412										
Ford H1BC-3051-AA	Ford H1BC-3051-AD										
Ford H1BC-3051-AE	Ford H1BC-3051-AF										
<p><b>Application info</b></p> <p>Ford Fiesta VII (05/17--)</p>											



<b>Control arm</b>	<b>716 050 0051</b>	<b>MCA0738</b>
--------------------	---------------------	----------------

**Notes**

Rear Axle Left  
 Rear Axle Right  
 Semi-Trailing Arm  
 Sheet Steel  
 with rubber mount

Required quantity  
 replacement in pairs recommended

2



**References**

Ford 1 122 566  
 Ford 1S71-5K652-BC  
 Jaguar C2S 24713

Ford 1 214 290  
 Ford 1S71-5K652-CA

**Application info**

Ford Mondeo III (10/00-09/07)

Jaguar X-Type (03/01-12/09)

<b>Control arm</b>	<b>716 050 0052/HD</b>	<b>MCA0739HD</b>
--------------------	------------------------	------------------

**Notes**

Carbon Neutral  
 Control Arm  
 Front Axle Left  
 Sheet Steel  
 with ball joint  
 with rubber mount

Paired article number  
 Replace in pairs only  
 Required quantity  
 reinforced version

716 050 0053/HD | MCA0740HD

1



**References**

Ford 1 502 087  
 Ford 8V41-3A424-AB

Ford 1 723 324  
 Ford 8V41-3A424-AC

**Application info**

Ford Kuga I (02/08-11/12)

**Control arm**

716 050 0053/HD

MCA0740HD

**Notes**

Carbon Neutral  
Control Arm  
Front Axle Right  
Sheet Steel  
with ball joint  
with rubber mount

Paired article number 716 050 0052/HD | MCA0739HD  
Replace in pairs only  
Required quantity 1  
reinforced version



**References**

Ford 1 502 086 Ford 1 723 323  
Ford 8V41-3A423-AB Ford 8V41-3A423-AC

**Application info**

Ford Kuga I (02/08-11/12)

**Control arm**

716 050 0057/HD

MCA1184HD

**Notes**

Carbon Neutral  
Control Arm  
Front Axle Left  
Lower  
Sheet Steel  
without ball joint

Paired article number 716 050 0058/HD | MCA1185HD  
Replace in pairs only  
Required quantity 1  
reinforced version



**References**

Ford 1 763 702 Ford 1 764 290  
Ford 1 791 958 Ford 1 831 355  
Ford 1 877 334 Ford 2 313 932  
Ford 2 598 805 Ford BK21-3A053-AB  
Ford BK21-3A053-AC Ford BK21-3A053-AD  
Ford BK21-3A053-AE Ford BK21-3A053-AF  
Ford BK21-3A053-AG Ford BK21-3A053-AH

**Application info**

Ford Tourneo '12 (04/12--)

Ford Transit '14 (08/13--)

Ford Transit Custom '12 (04/12--)

**Control arm**

716 050 0058/HD

MCA1185HD

**Notes**

Carbon Neutral  
Control Arm  
Front Axle Right  
Lower  
Sheet Steel  
without ball joint

Paired article number

716 050 0057/HD | MCA1184HD

Replace in pairs only

Required quantity

1

reinforced version



**References**

Ford 1 763 701

Ford 1 764 289

Ford 1 782 112

Ford 1 831 354

Ford 1 877 332

Ford 2 313 930

Ford 2 598 804

Ford BK21-3A052-AB

Ford BK21-3A052-AC

Ford BK21-3A052-AD

Ford BK21-3A052-AE

Ford BK21-3A052-AF

Ford BK21-3A052-AG

Ford BK21-3A052-AH

**Application info**

Ford Tourneo '12 (04/12--)

Ford Transit '14 (08/13--)

Ford Transit Custom '12 (04/12--)

**Control arm**

716 050 0063

MCA1253

**Notes**

Lower  
Rear  
Rear Axle Left  
Rear Axle Right  
Semi-Trailing Arm  
Sheet Steel  
outer

Required quantity

2

replacement in pairs recommended



**References**

Ford 1 719 027	Ford 1 743 421
Ford 1 785 675	Ford 1 882 884
Ford 1 931 562	Ford BV61-5K652-FB
Ford BV61-5K652-FC	Ford BV61-5K652-FD
Ford BV61-5K652-FE	Ford BV61-5K652-FF

**Application info**

Ford Focus III (07/10--)

**Control arm**

716 050 0064

MCA1286

**Notes**

Lower  
Rear  
Rear Axle Left  
Rear Axle Right  
Semi-Trailing Arm  
Sheet Steel

Required quantity  
replacement in pairs recommended

2



**References**

Ford 1 719 019	Ford 1 743 420
Ford 1 785 674	Ford 1 882 883
Ford 1 948 762	Ford BV61-5K652-ED
Ford BV61-5K652-EE	Ford BV61-5K652-EF
Ford BV61-5K652-EG	Ford BV61-5K652-EH

**Application info**

Ford Focus III (07/10--)

**Control arm**

716 050 0065

MCA1254

**Notes**

Lower  
Rear Axle Left  
Rear Axle Right  
Semi-Trailing Arm  
Sheet Steel

Required quantity  
replacement in pairs recommended

2



**References**

Ford 1 686 705	Ford 1 694 569
Ford 1 719 006	Ford 1 744 421
Ford 1 785 667	Ford 1 882 880
Ford 1 894 049	Ford BV61-5K652-AB
Ford BV61-5K652-AC	Ford BV61-5K652-AD
Ford BV61-5K652-AE	Ford BV61-5K652-AF
Ford BV61-5K652-AG	Ford BV61-5K652-AH
Volvo 31317264	Volvo 31387062

**Application info**

Ford C-Max II (04/10--)	Ford Focus III (07/10--)
Volvo V40 II (03/12--)	

**Control arm**

716 050 0066/HD

MCA1204HD

**Notes**

Carbon Neutral  
 Lower  
 Rear Axle Right  
 Sheet Steel  
 Trailing Arm  
 outer  
 Paired article number 716 050 0067/HD | MCA1205HD

Replace in pairs only  
 Required quantity 1  
 reinforced version









**References**

Ford 1 773 552	Ford BV61-5K898-AB
----------------	--------------------

**Application info**

Ford Focus III (07/10--)

Control arm		716 050 0067/HD	MCA1205HD
<p><b>Notes</b></p> <p>Carbon Neutral Lower Rear Axle Left Sheet Steel Trailing Arm outer</p> <p>Paired article number Replace in pairs only Required quantity reinforced version</p>		 	
<p>716 050 0066/HD   MCA1204HD</p> <p>1</p>			
<p><b>References</b></p> <p>Ford 1 773 553 Ford BV61-5K976-AB</p>			
<p><b>Application info</b></p> <p>Ford Focus III (07/10--)</p>			
Control arm		716 050 0068/HD	MCA1296HD
<p><b>Notes</b></p> <p>Carbon Neutral Control Arm Front Axle Right Lower Sheet Steel outer</p> <p>Paired article number Paired article number Replace in pairs only Required quantity reinforced version</p>		 	
<p>716 050 0069</p> <p>716 050 0069/HD   MCA1297HD</p> <p>1</p>			
<p><b>References</b></p> <p>Ford 1 781 658 Ford 1 793 236 Ford CV61-3A423-AAB Ford CV61-3A423-AAC</p>			
<p><b>Application info</b></p> <p>Ford Kuga II (05/12--)</p>			

Control arm		716 050 0069/HD	MCA1297HD
<p><b>Notes</b></p> <p>Carbon Neutral Control Arm Front Axle Left Lower Sheet Steel outer</p> <p>Paired article number Replace in pairs only Required quantity reinforced version</p>		 <p>MEYLE Carbon Neutral Control Arm Front Axle Left Lower Sheet Steel outer</p>	
<p>716 050 0068/HD   MCA1296HD</p> <p>1</p>			
<p><b>References</b></p> <p>Ford 1 781 660 Ford 1 793 237 Ford CV61-3A424-AAB Ford CV61-3A424-AAC</p>			
<p><b>Application info</b></p> <p>Ford Kuga II (05/12--)</p>			
Control arm		716 050 0070/HD	MCA1303HD
<p><b>Notes</b></p> <p>Carbon Neutral Control Arm Front Axle Right Lower Sheet Steel outer</p> <p>Paired article number Replace in pairs only Required quantity reinforced version</p>		 <p>MEYLE Carbon Neutral Control Arm Front Axle Right Lower Sheet Steel outer</p>	
<p>716 050 0071/HD   MCA1304HD</p> <p>1</p>			
<p><b>References</b></p> <p>Ford 1 773 516 Ford 1 805 952 Ford 1 866 070 Ford BV61-3A423-LAA Ford BV61-3A423-LAB Ford F1F13-A423B-AA</p>			
<p><b>Application info</b></p> <p>Ford Focus III (07/10--)</p>			

**Control arm**

716 050 0071/HD

MCA1304HD

**Notes**

Carbon Neutral  
Control Arm  
Front Axle Left  
Lower  
Sheet Steel  
outer



Paired article number 716 050 0070/HD | MCA1303HD  
Replace in pairs only  
Required quantity 1  
reinforced version

**References**

Ford 1 773 518 Ford 1 805 953  
Ford 1 866 072 Ford BV61-3A424-LAA  
Ford BV61-3A424-LAB Ford F1F1-3A424-BAA

**Application info**

Ford Focus III (07/10--)

**Control arm**

716 050 0073/HD

MCA1368HD

**Notes**

Aluminium  
Carbon Neutral  
Control Arm  
Front Axle Left



Paired article number 716 050 0074/HD | MCA1369HD  
Replace in pairs only  
Required quantity 1  
reinforced version

**References**

Ford 1 927 132 Ford 2 180 769  
Ford 5 232 481 Ford 5 303 329  
Ford DG9C-3A053-ANE Ford FG9C-3A053-ANA  
Ford FG9C-3A053-ANB Ford FG9C-3A053-ANC

**Application info**

Ford Mondeo V (09/12--)



**Control arm** **716 050 0074/HD** **MCA1369HD**

**Notes**

Aluminium  
Carbon Neutral  
Control Arm  
Front Axle Right  
Paired article number  
716 050 0073/HD | MCA1368HD

Replace in pairs only  
Required quantity  
reinforced version

1



**References**

Ford 1 927 131	Ford 2 180 767
Ford 5 232 480	Ford 5 303 328
Ford DG9C-3A052-ANE	Ford FG9C-30A052-ANC
Ford FG9C-3A052-ANA	Ford FG9C-3A052-ANB

**Application info**

Ford Mondeo V (09/12--)

**Control arm** **716 050 0077** **MCA1344**

**Notes**

Front  
Lower  
Rear Axle Left  
Rear Axle Right  
Semi-Trailing Arm  
Sheet Steel

Required quantity  
replacement in pairs recommended

2



**References**

Ford 1 123 275	Ford 1 201 057
Ford 1 220 005	Ford 1 230 619
Ford 1S71-5K743-BA	Ford 1S71-5K743-CA
Ford 2S71-5K743-AA	Ford 2S71-5K743-BA
Ford 6 748 372	Ford 6 829 064
Ford 6 875 579	Ford 7 043 630
Ford 93BB-5K743-CA	Ford 93BB-5K743-CB
Ford 93BB-5K743-CD	

**Application info**

Ford Mondeo I, II (01/93-09/00)

Ford Mondeo III (10/00-09/07)

**Control arm**

716 050 0078/HD

MCA1625HD

**Notes**

Aluminium  
Carbon Neutral  
Control Arm  
Front Axle Right  
Lower

Paired article number 716 050 0079/HD | MCA1626HD  
Replace in pairs only  
Required quantity 1  
reinforced version



**References**

Ford 1 877 652

Ford E1GC-3A052-AEB

**Application info**

Ford Galaxy III (01/15--)

Ford S-Max II (01/15--)

**Control arm**

716 050 0079/HD

MCA1626HD

**Notes**

Aluminium  
Carbon Neutral  
Control Arm  
Front Axle Left  
Lower

Paired article number 716 050 0078/HD | MCA1625HD  
Replace in pairs only  
Required quantity 1  
reinforced version



**References**

Ford 1 877 653

Ford E1GC-3A053-AEB

**Application info**

Ford Galaxy III (01/15--)

Ford S-Max II (01/15--)

**Control arm**

716 050 0082

MCA1537

**Notes**

Control Arm  
Rear Axle Left  
Rear Axle Right  
Sheet Steel  
Upper

Required quantity  
replacement in pairs recommended

**References**

Ford 2 216 285

Ford JX61-5500-AEA

**Application info**

Ford Focus IV (01/18--)

**Control arm**

716 050 0083

MCA1568

**Notes**

Control Arm  
Rear Axle Left  
Rear Axle Right  
Sheet Steel

Required quantity  
replacement in pairs recommended

**References**

Ford 2 200 527

Ford 2 428 955



Ford JX61-5K743-AEA

Ford JX61-5K743-AEB

**Application info**

Ford Focus IV (01/18--)

Ford Kuga III (07/19--)

Control arm		716 050 4150	MCA0754																		
<p><b>Notes</b></p> <p>Control Arm Front Axle Right Lower Sheet Steel with ball joint with rubber mount</p> <p>Length [mm] 246 Paired article number 716 050 4159   MCA0755 Required quantity 1 replacement in pairs recommended</p>																					
<p><b>References</b></p> <table border="0"> <tr> <td>Ford 1 015 260</td> <td>Ford 1 020 219</td> </tr> <tr> <td>Ford 1 021 219</td> <td>Ford 1 071 694</td> </tr> <tr> <td>Ford 1 330 238</td> <td>Ford 1 710 792</td> </tr> <tr> <td>Ford 4S61-3042-CA</td> <td>Ford 96FB-3042-AH</td> </tr> <tr> <td>Ford 96FB-3042-BE</td> <td>Ford 96FB-3042-BF</td> </tr> <tr> <td>Ford 98FB-3042-CD</td> <td>Ford ME96FB-3042-CA</td> </tr> <tr> <td>Mazda 1E01-34 300B</td> <td>Mazda 1E01-34 300C</td> </tr> <tr> <td>Mazda 1E01-34 300D</td> <td>Mazda 1E01-34 300G</td> </tr> <tr> <td>Mazda 1E01-34-300A</td> <td>Mazda 1E01-34-300E</td> </tr> </table>				Ford 1 015 260	Ford 1 020 219	Ford 1 021 219	Ford 1 071 694	Ford 1 330 238	Ford 1 710 792	Ford 4S61-3042-CA	Ford 96FB-3042-AH	Ford 96FB-3042-BE	Ford 96FB-3042-BF	Ford 98FB-3042-CD	Ford ME96FB-3042-CA	Mazda 1E01-34 300B	Mazda 1E01-34 300C	Mazda 1E01-34 300D	Mazda 1E01-34 300G	Mazda 1E01-34-300A	Mazda 1E01-34-300E
Ford 1 015 260	Ford 1 020 219																				
Ford 1 021 219	Ford 1 071 694																				
Ford 1 330 238	Ford 1 710 792																				
Ford 4S61-3042-CA	Ford 96FB-3042-AH																				
Ford 96FB-3042-BE	Ford 96FB-3042-BF																				
Ford 98FB-3042-CD	Ford ME96FB-3042-CA																				
Mazda 1E01-34 300B	Mazda 1E01-34 300C																				
Mazda 1E01-34 300D	Mazda 1E01-34 300G																				
Mazda 1E01-34-300A	Mazda 1E01-34-300E																				
<p><b>Application info</b></p> <table border="0"> <tr> <td>Ford Fiesta IV / Puma (08/95--)</td> <td>Mazda 121 (JASM, JBSM) (01/96-04/03)</td> </tr> </table>				Ford Fiesta IV / Puma (08/95--)	Mazda 121 (JASM, JBSM) (01/96-04/03)																
Ford Fiesta IV / Puma (08/95--)	Mazda 121 (JASM, JBSM) (01/96-04/03)																				
Control arm		716 050 4159	MCA0755																		
<p><b>Notes</b></p> <p>Control Arm Front Axle Left Lower Sheet Steel with ball joint with rubber mount</p> <p>Length [mm] 246 Paired article number 716 050 4150   MCA0754 Required quantity 1 replacement in pairs recommended</p>																					

**References**

- |                    |                     |
|--------------------|---------------------|
| Ford 1 009 596     | Ford 1 015 264      |
| Ford 1 020 221     | Ford 1 021 220      |
| Ford 1 072 279     | Ford 1 330 239      |
| Ford 1 710 796     | Ford 4S61-3051-CA   |
| Ford 98FB-3051-CD  | Ford ME96F-B3051-CA |
| Mazda 1E01-34 350G | Mazda 1E01-34 540A  |
| Mazda 1E01-34 540B | Mazda 1E01-34 540C  |
| Mazda 1E01-34 540D | Mazda 1E01-34 540E  |
| Mazda 1E01-34-350A | Mazda 1E01-34-350B  |
| Mazda 1E01-34-350D | Mazda 1E01-34-350E  |

**Application info**

- |                                 |                                      |
|---------------------------------|--------------------------------------|
| Ford Fiesta IV / Puma (08/95--) | Mazda 121 (JASM, JBSM) (01/96-04/03) |
|---------------------------------|--------------------------------------|

**Control arm**

716 050 4162

MCA1453

**Notes**

Control Arm  
 Front Axle Right  
 Sheet Steel  
 Paired article number 716 050 4163 | MCA1454  
 Required quantity 1  
 replacement in pairs recommended



**References**

- |                     |                     |
|---------------------|---------------------|
| Ford 2 194 097      | Ford 2 203 137      |
| Ford JX61-3A423-AEA | Ford JX61-3A423-AEB |

**Application info**

- Ford Focus IV (01/18--)

<b>Control arm</b>	<b>716 050 4163</b>	<b>MCA1454</b>
--------------------	---------------------	----------------

**Notes**

Control Arm  
 Front Axle Left  
 Sheet Steel

Paired article number 716 050 4162 | MCA1453  
 Required quantity 1  
 replacement in pairs recommended



**References**

Ford 2 194 099	Ford 2 203 138
Ford JX61-3A424-AEA	Ford JX61-3A424-AEB

**Application info**

Ford Focus IV (01/18--)

<b>Control arm</b>	<b>716 050 4164/HD</b>	<b>MCA1450HD</b>
--------------------	------------------------	------------------

**Notes**

Carbon Neutral  
 Control Arm  
 Front Axle Right  
 Lower  
 Sheet Steel

Paired article number 716 050 4165/HD | MCA1451HD  
 Replace in pairs only  
 Required quantity 1  
 reinforced version



**References**

Ford 2 216 265	Ford JX61-3A423-CEB
----------------	---------------------

**Application info**

Ford Focus IV (01/18--)

**Control arm**

716 050 4165/HD

MCA1451HD

**Notes**

Carbon Neutral  
Control Arm  
Front Axle Left  
Lower  
Sheet Steel  
Paired article number 716 050 4164/HD | MCA1450HD  
Replace in pairs only  
Required quantity 1



**References**

Ford 2 216 267

Ford JX61-3A424-CEB

**Application info**

Ford Focus IV (01/18--)

**Control arm**

816 050 9005/HD

MCA0760HD

**Notes**

Aluminium  
Carbon Neutral  
Control Arm  
Front  
Front Axle Left  
Lower  
with rubber mount  
Length [mm] 354  
Paired article number 816 050 9006/HD | MCA0761HD  
Replace in pairs only  
Required quantity 1  
reinforced version

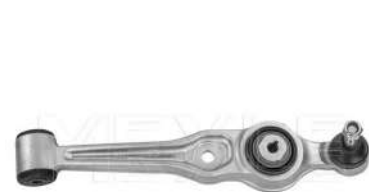

**References**

Saab 45 43 450

**Application info**

Saab 9-3 (YS3D) (02/98-08/03)

Saab 900 II (07/93-04/99)

**Control arm**

816 050 9006/HD

MCA0761HD

**Notes**

Aluminium  
Carbon Neutral  
Control Arm  
Front  
Front Axle Right  
Lower  
with rubber mount



Length [mm]

354

Paired article number

816 050 9005/HD | MCA0760HD

Replace in pairs only

Required quantity  
reinforced version

1

**References**

Saab 45 43 468

**Application info**

Saab 9-3 (YS3D) (02/98-08/03)

Saab 900 II (07/93-04/99)

**Control arm set**

70-16 050 0039/HD

MCK0058HD

**Notes**

Aluminium  
Carbon Neutral  
Front Axle Left  
Front Axle Right  
Upper



Required quantity  
reinforced version

1

**References**

TESLA 1044321-00-F  
TESLA 1044321-00-H  
TESLA 1044326-00-F  
TESLA 1044326-00-H  
TESLA 1288321-00-A

TESLA 1044321-00-G  
TESLA 1044321-00-J  
TESLA 1044326-00-G  
TESLA 1044326-00-J  
TESLA 1288326-00-A

**Application info**

TESLA Model 3 (01/17--)

TESLA Model Y (03/19--)



**Control arm set**

716 050 0039/S

MCK0027

**Notes**

Control Arm  
Rear Axle Left  
Rear Axle Right  
Sheet Steel

Full Set

Required quantity

1



**References**

Ford 1 061 659

Ford 1 064 128

Ford 1 136 072

Ford 1 253 737

Ford 1 317 609

Ford 1 329 730

Ford 1 349 910

Ford 1 357 317

Ford 1 517 403

Ford 1 755 222

Ford 1M51-5500-AA

Ford 1M51-5500-AC

Ford 3M51-5500-BA

Ford 3M51-5K652-GD

Ford 4M51-5K652-AA

Ford 4M51-5K652-AC

Ford 4M51-5K652-AF

Ford 8V41-5K743-AA

Ford 98AG-5K743-AF

Ford AV61-5500-AC

Ford 1 061 668

Ford 1 105 524

Ford 1 223 897

Ford 1 306 767

Ford 1 321 004

Ford 1 333 283

Ford 1 352 302

Ford 1 500 111

Ford 1 683 463

Ford 1 909 108

Ford 1M51-5500-AB

Ford 3M51-5500-AC

Ford 3M51-5K652-GB

Ford 3N61-5K743-BB

Ford 4M51-5K652-AB

Ford 4M51-5K652-AD

Ford 8M51-5500-AB

Ford 98AG-5500-AG

Ford AV61-5500-AB

Ford YS41-5K743-AB

**Application info**

Ford Focus I (08/98-11/09)

Ford Focus II (10/03--)

**Control arm set**

716 050 0042/S

MCK0029

**Notes**

Control Arm  
Rear Axle Left  
Rear Axle Right  
Sheet Steel  
with attachment material

Full Set  
Required quantity

1



**References**

- |                    |                    |
|--------------------|--------------------|
| Ford 1 061 660     | Ford 1 061 668     |
| Ford 1 100 983     | Ford 1 105 524     |
| Ford 1 136 073     | Ford 1 306 767     |
| Ford 1 321 004     | Ford 1 333 283     |
| Ford 1 349 213     | Ford 1 349 910     |
| Ford 1 352 302     | Ford 1 357 317     |
| Ford 1 357 319     | Ford 1 388 327     |
| Ford 1 448 127     | Ford 1 500 111     |
| Ford 1 502 440     | Ford 1 909 108     |
| Ford 1M51-5500-BA  | Ford 3M51-5K652-GB |
| Ford 3M51-5K652-GD | Ford 3N61-5K743-BB |
| Ford 4M51-5K652-AA | Ford 4M51-5K652-AB |
| Ford 4M51-5K652-AC | Ford 4M51-5K652-AD |
| Ford 4M51-5K652-AF | Ford 4M51-5K652-BC |
| Ford 4M51-5K652-BD | Ford 6M51-5500-BA  |
| Ford 8V41-5500-AA  | Ford 8V41-5K743-AA |
| Ford 98AG-5500-BF  | Ford 98AG-5K743-AF |
| Ford YS41-5K743-AA | Ford YS41-5K743-AB |

**Application info**

- |                            |                         |
|----------------------------|-------------------------|
| Ford Focus I (08/98-11/09) | Ford Focus II (10/03--) |
|----------------------------|-------------------------|

**Mount, control arm**

414 710 0001

MCB0547

**Notes**

Rear Axle Left  
 Rear Axle Right  
 Rubber/Metal  
 inner  
 outer  
 without holder

Height [mm] 24  
 Inner Diameter [mm] 12.1  
 Outer Diameter [mm] 40  
 Required quantity 4  
 replacement in pairs recommended



**References**

Porsche 970 331 043 00

Porsche 970 331 047 00

**Application info**

Porsche Panamera (970) (03/09-12/17)

**Mount, control arm**

44-14 610 0000

MCB0269

**Notes**

Front Axle Left  
 Front Axle Right  
 Rear  
 without holder

Height [mm] 62  
 Inner Diameter [mm] 16  
 Outer Diameter [mm] 54  
 Required quantity 2  
 replacement in pairs recommended



**References**

Chrysler 04656012AC

Chrysler 4656012AF

**Application info**

Chrysler PT Cruiser (06/00-12/10)

**Mount, control arm** **44-14 610 0001** **MCB0270**

**Notes**

Front  
 Front Axle Left  
 Front Axle Right  
 without holder

Height [mm] 69  
 Inner Diameter [mm] 14  
 Outer Diameter [mm] 34  
 Required quantity 2  
 replacement in pairs recommended



**References**

Chrysler 04656730AH Chrysler 04656731AH

**Application info**

Chrysler PT Cruiser (06/00-12/10)

**Mount, control arm** **44-14 610 0002** **MCB0425**

**Notes**

Front  
 Front Axle Left  
 Front Axle Right  
 Lower  
 without holder

Height [mm] 68  
 Inner Diameter [mm] 14  
 Outer Diameter [mm] 52  
 Required quantity 2  
 replacement in pairs recommended



**References**

Chrysler 4684120

**Application info**

Chrysler Voyager IV/ Town Country (09/99-12/08)

**Mount, control arm**

44-14 610 0004

MCM0162

**Notes**

Front Axle Left  
 Front Axle Right  
 Hydro Mount  
 Lower  
 Rear  
 without holder

Height [mm] 61  
 Inner Diameter [mm] 16  
 Required quantity 2  
 replacement in pairs recommended

**References**

Chrysler 4743094AA

Chrysler 4743095AA

**Application info**

Chrysler Voyager IV/ Town Country (09/99-12/08)

**Mount, control arm**

44-16 010 6313

MCM0152

**Notes**

Rear Axle Left  
 Rear Axle Right  
 outer  
 without holder

Height [mm] 48  
 Inner Diameter [mm] 14  
 Outer Diameter [mm] 40  
 Required quantity 2  
 replacement in pairs recommended

**References**

Chrysler 04782598AC

Chrysler 04782598AF

Chrysler 04782598AG

Lancia K04782598AE

Lancia K04782598AF

Lancia K04782598AG

**Application info**

Chrysler 300 C (09/04--)

Lancia Thema II (09/11-10/14)

**Mount, control arm**

514 308 0001

MCB0277

**Notes**

Front  
Front Axle Left  
Front Axle Right  
Lower  
without holder

Height [mm] 60  
Inner Diameter [mm] 12  
Outer Diameter [mm] 36  
Required quantity 2  
replacement in pairs recommended



**References**

Mitsubishi MR130982 Proton MR130982  
Volvo 30818467 Volvo 30887024

**Application info**

Mitsubishi Carisma (07/95-06/06) Mitsubishi Colt IV (03/92-04/96)  
Mitsubishi Lancer V (07/91-10/03) Proton Persona 400 (01/94-02/08)  
Volvo S/V 40 (07/95-12/04) Volvo S40 II / V50 (12/03-12/12)

**Mount, control arm**

514 610 0001/HD

MCB0279HD

**Notes**

Carbon Neutral  
Front Axle Left  
Front Axle Right  
Lower  
Rear  
without holder

Height [mm] 50  
Inner Diameter [mm] 14  
Outer Diameter [mm] 53  
Replace in pairs only  
Required quantity 2  
reinforced version



**References**

Volvo 30645847 Volvo 31201003  
Volvo 31304040 Volvo 8672224

**Application info**

Volvo XC90 I (06/02-01/15)

**Mount, control arm**

514 610 0002/HD

MCB0280HD

**Notes**

Carbon Neutral  
 Front  
 Front Axle Left  
 Front Axle Right  
 Lower  
 without holder

Height [mm]

60

Outer Diameter [mm]

59

Replace in pairs only

Required quantity

2

reinforced version

**References**

Volvo 30639368

Volvo 31277881

**Application info**

Volvo XC90 I (06/02-01/15)

**Mount, control arm**

514 610 0003

MCB0281

**Notes**

Centre  
 Front Axle Left  
 Front Axle Right  
 without holder

Height [mm]

65

Inner Diameter [mm]

14

Outer Diameter [mm]

40

Required quantity

2

replacement in pairs recommended

**References**The references of this product can be found at [www.meyle.com](http://www.meyle.com)**Application info**

Ford C-Max I (02/07-09/10)

Ford Kuga I (02/08-11/12)

Mazda 5 (CR) (02/05-12/10)

Volvo C30 (09/06-12/13)

Volvo S40 II / V50 (12/03-12/12)

Ford Focus II (10/03--)

Mazda 3 (BK) (09/99-12/09)

Mazda 5 (CW) (06/10--)

Volvo C70 II (03/06-12/13)

## Mount, control arm

514 610 0005/HD

MCB0283HD

## Notes

Carbon Neutral  
 Front Axle Left  
 Front Axle Right  
 Lower  
 Rear  
 without holder

Height [mm]

50

Inner Diameter [mm]

14

Outer Diameter [mm]

53

Replace in pairs only

Required quantity

2

reinforced version



## References

Volvo 30760590

Volvo 8630604

Volvo 9461626

## Application info

Volvo S60 I / V70 II (11/99-04/10)

Volvo S80 I (05/98-02/08)

## Mount, control arm

514 610 0006/HD

MCB0284HD

## Notes

Carbon Neutral  
 Front  
 Front Axle Left  
 Front Axle Right  
 Lower  
 without holder

Height [mm]

55

Outer Diameter [mm]

48

Replace in pairs only

Required quantity

2

reinforced version



## References

Volvo 9443882

Volvo 9465971

## Application info

Volvo S60 I / V70 II (11/99-04/10)

Volvo S80 I (05/98-02/08)

Volvo XC70 I (10/97-10/07)



**Mount, control arm**

514 610 0010

MCB0285

**Notes**

Front Axle Left  
 Front Axle Right  
 Lower  
 Rear  
 without holder

Height [mm] 50  
 Inner Diameter [mm] 14  
 Outer Diameter [mm] 53  
 Required quantity 2  
 replacement in pairs recommended



**References**

Volvo 8630605

**Application info**

Volvo XC70 I (10/97-10/07)

**Mount, control arm**

514 610 0016

MCM0204

**Notes**

Front Axle Left  
 Front Axle Right  
 Rubber-Metal Mount  
 Upper  
 inner  
 without holder

Height [mm] 28  
 Inner Diameter [mm] 10  
 Outer Diameter [mm] 40  
 Required quantity 2  
 replacement in pairs recommended



**References**

POLESTAR 31360836  
 POLESTAR 32395244  
 Volvo 31360632  
 Volvo 31360836  
 Volvo 31476301  
 Volvo 32395244

POLESTAR 31360837  
 Volvo 31360630  
 Volvo 31360633  
 Volvo 31360837  
 Volvo 31476302

**Application info**

POLESTAR POLESTAR 1 (03/18--)

Volvo S90 II / V90 II (03/16--)

Volvo XC60 II (03/17--)

Volvo S60 III (224) (02/19--)

Volvo V60 II (02/18--)

Volvo XC90 II (09/14--)

**Mount, control arm**

514 710 0014

MCM0100

**Notes**

Front  
 Lower  
 Rear Axle Left  
 with holder  
 Outer Diameter [mm] 90  
 Paired article number 514 710 0015 | MCM0101  
 Required quantity 1

replacement in pairs recommended



**References**

Ford 1 377 409	Ford 1 377 410
Ford 1 381 438	Ford 1 381 439
Ford 1 385 597	Ford 1 385 598
Ford 1 425 851	Ford 1 425 852
Ford 1 428 820	Ford 1 428 822
Ford 1 460 464	Ford 1 460 468
Ford 1 462 032	Ford 1 462 033
Ford 1 466 174	Ford 1 466 175
Ford 1 468 194	Ford 1 468 195
Ford 1 477 809	Ford 1 477 810
Ford 1 493 626	Ford 1 493 627
Ford 1 496 728	Ford 1 504 892
Ford 1 510 965	Ford 1 566 837
Ford 1 566 838	Ford 1 566 839
Ford 1 566 841	Ford 1 839 442
Ford 1 839 444	Ford 1 865 033
Ford 2 040 702	Ford 6G91-5A969-FAG
Ford 6G91-5A969-FCJ	Ford 6G91-5A969-FEB
Ford 6G91-5A969-FNJ	Ford 6G91-5K896-AA
Ford 6G915-A969F-CA	Ford 6G915-A969F-CB
Ford 6G915-A969F-CC	Ford 6G915-A969F-CD
Ford 6G915-A969F-CE	Ford 6G915-A969F-CF
Ford 6G915-A969F-CG	Ford 6G915-A969F-CH
Ford 6G915-A969F-NA	Ford 6G915-A969F-NB
Ford 6G915-A969F-NC	Ford 6G915-A969F-ND
Ford 6G915-A969F-NE	Ford 6G915-A969F-NF
Ford 6G915-A969F-NG	Ford 6G915-A969F-NH
Volvo 31387280	Volvo 31406337
Volvo 31476221	

**Application info**

Ford Galaxy II (05/06-06/15)	Ford Mondeo IV (03/07-01/15)
Ford S-Max I (05/06-12/14)	Volvo S60 II / V60 (04/10--)
Volvo S80 II (03/06-12/16)	Volvo V70 III (04/07--)
Volvo XC60 I (05/08-12/17)	Volvo XC70 II (04/07-12/16)

## Mount, control arm

514 710 0014/HD

MCM0100HD

## Notes

Carbon Neutral

Front

Lower

Rear Axle Left

with holder

90

514 710 0015/HD | MCM0101HD

Outer Diameter [mm]

Paired article number

Replace in pairs only

Required quantity

1

reinforced version



## References

Ford 1 377 409

Ford 1 381 438

Ford 1 385 597

Ford 1 425 851

Ford 1 428 820

Ford 1 460 464

Ford 1 462 032

Ford 1 466 174

Ford 1 468 194

Ford 1 477 809

Ford 1 493 626

Ford 1 496 728

Ford 1 510 965

Ford 1 566 838

Ford 1 566 841

Ford 1 839 444

Ford 2 040 702

Ford 6G91-5A969-FCJ

Ford 6G91-5A969-FNJ

Ford 6G915-A969F-CA

Ford 6G915-A969F-CC

Ford 6G915-A969F-CE

Ford 6G915-A969F-CG

Ford 6G915-A969F-NA

Ford 6G915-A969F-NC

Ford 6G915-A969F-NE

Ford 6G915-A969F-NG

Volvo 31387280

Volvo 31476221

Ford 1 377 410

Ford 1 381 439

Ford 1 385 598

Ford 1 425 852

Ford 1 428 822

Ford 1 460 468

Ford 1 462 033

Ford 1 466 175

Ford 1 468 195

Ford 1 477 810

Ford 1 493 627

Ford 1 504 892

Ford 1 566 837

Ford 1 566 839

Ford 1 839 442

Ford 1 865 033

Ford 6G91-5A969-FAG

Ford 6G91-5A969-FEB

Ford 6G91-5K896-AA

Ford 6G915-A969F-CB

Ford 6G915-A969F-CD

Ford 6G915-A969F-CF

Ford 6G915-A969F-CH

Ford 6G915-A969F-NB

Ford 6G915-A969F-ND

Ford 6G915-A969F-NF

Ford 6G915-A969F-NH

Volvo 31406337

**Application info**

Ford Galaxy II (05/06-06/15)  
 Ford S-Max I (05/06-12/14)  
 Volvo S80 II (03/06-12/16)  
 Volvo XC60 I (05/08-12/17)

Ford Mondeo IV (03/07-01/15)  
 Volvo S60 II / V60 (04/10--)  
 Volvo V70 III (04/07--)  
 Volvo XC70 II (04/07-12/16)

**Mount, control arm**

514 710 0015

MCM0101

**Notes**

Front  
 Lower  
 Rear Axle Right  
 with holder

Outer Diameter [mm] 90  
 Paired article number  
 Required quantity 1  
 replacement in pairs recommended



**References**

Ford 1 377 406	Ford 1 377 407
Ford 1 381 436	Ford 1 381 437
Ford 1 385 595	Ford 1 385 596
Ford 1 425 848	Ford 1 425 850
Ford 1 428 815	Ford 1 428 818
Ford 1 460 439	Ford 1 460 450
Ford 1 462 030	Ford 1 462 031
Ford 1 466 171	Ford 1 466 172
Ford 1 468 192	Ford 1 468 193
Ford 1 477 806	Ford 1 477 807
Ford 1 493 624	Ford 1 493 625
Ford 1 496 725	Ford 1 508 128
Ford 1 510 964	Ford 1 566 810
Ford 1 566 829	Ford 1 566 835
Ford 1 566 836	Ford 1 839 438
Ford 1 839 440	Ford 1 865 034
Ford 2 040 703	Ford 6G91-5A968-FAC
Ford 6G91-5A968-FAD	Ford 6G91-5A968-FAE
Ford 6G91-5A968-FAF	Ford 6G91-5A968-FAG
Ford 6G91-5A968-FBC	Ford 6G91-5A968-FBE
Ford 6G91-5A968-FBF	Ford 6G91-5A968-FCJ
Ford 6G91-5A968-FCK	Ford 6G91-5A968-FEA
Ford 6G91-5A968-FEB	Ford 6G91-5A968-FNJ
Ford 6G91-5A968-FNK	Ford 6G91-5A968-FUP
Ford 6G91-5K896-BA	Ford 6G91-5K896-BB
Ford 6G915-A968F-CA	Ford 6G915-A968F-CB
Ford 6G915-A968F-CC	Ford 6G915-A968F-CD
Ford 6G915-A968F-CE	Ford 6G915-A968F-CF
Ford 6G915-A968F-CG	Ford 6G915-A968F-CH
Ford 6G915-A968F-NA	Ford 6G915-A968F-NB
Ford 6G915-A968F-NC	Ford 6G915-A968F-ND
Ford 6G915-A968F-NE	Ford 6G915-A968F-NF
Ford 6G915-A968F-NG	Ford 6G915-A968F-NH
Volvo 31387281	Volvo 31406350
Volvo 31476222	

**Application info**

Ford Galaxy II (05/06-06/15)	Ford Mondeo IV (03/07-01/15)
Ford S-Max I (05/06-12/14)	Volvo S60 II / V60 (04/10--)
Volvo S80 II (03/06-12/16)	Volvo V70 III (04/07--)
Volvo XC60 I (05/08-12/17)	Volvo XC70 II (04/07-12/16)

Mount, control arm

514 710 0015/HD

MCM0101HD

Notes

Carbon Neutral  
Front  
Lower  
Rear Axle Right

Outer Diameter [mm]  
Paired article number  
Replace in pairs only  
Required quantity  
reinforced version

90  
  
  
1





**References**

Ford 1 377 406	Ford 1 377 407
Ford 1 381 436	Ford 1 381 437
Ford 1 385 595	Ford 1 385 596
Ford 1 425 848	Ford 1 425 850
Ford 1 428 815	Ford 1 428 818
Ford 1 460 439	Ford 1 460 450
Ford 1 462 030	Ford 1 462 031
Ford 1 466 171	Ford 1 466 172
Ford 1 468 192	Ford 1 468 193
Ford 1 477 806	Ford 1 477 807
Ford 1 493 624	Ford 1 493 625
Ford 1 496 725	Ford 1 508 128
Ford 1 510 964	Ford 1 566 810
Ford 1 566 829	Ford 1 566 835
Ford 1 566 836	Ford 1 839 438
Ford 1 839 440	Ford 1 865 034
Ford 2 040 703	Ford 6G91-5A968-FAC
Ford 6G91-5A968-FAD	Ford 6G91-5A968-FAE
Ford 6G91-5A968-FAF	Ford 6G91-5A968-FAG
Ford 6G91-5A968-FBC	Ford 6G91-5A968-FBE
Ford 6G91-5A968-FBF	Ford 6G91-5A968-FCJ
Ford 6G91-5A968-FCK	Ford 6G91-5A968-FEA
Ford 6G91-5A968-FEB	Ford 6G91-5A968-FNJ
Ford 6G91-5A968-FNK	Ford 6G91-5A968-FUP
Ford 6G91-5K896-BA	Ford 6G91-5K896-BB
Ford 6G915-A968F-CA	Ford 6G915-A968F-CB
Ford 6G915-A968F-CC	Ford 6G915-A968F-CD
Ford 6G915-A968F-CE	Ford 6G915-A968F-CF
Ford 6G915-A968F-CG	Ford 6G915-A968F-CH
Ford 6G915-A968F-NA	Ford 6G915-A968F-NB
Ford 6G915-A968F-NC	Ford 6G915-A968F-ND
Ford 6G915-A968F-NE	Ford 6G915-A968F-NF
Ford 6G915-A968F-NG	Ford 6G915-A968F-NH
Volvo 31387281	Volvo 31406350
Volvo 31476222	

**Application info**

Ford Galaxy II (05/06-06/15)	Ford Mondeo IV (03/07-01/15)
Ford S-Max I (05/06-12/14)	Volvo S60 II / V60 (04/10--)
Volvo S80 II (03/06-12/16)	Volvo V70 III (04/07--)
Volvo XC60 I (05/08-12/17)	Volvo XC70 II (04/07-12/16)



Mount, control arm		514 710 0016/HD	MCM0153HD
<p><b>Notes</b></p> <p>Carbon Neutral Rear Axle Left with holder</p> <p>Outer Diameter [mm] 90 Paired article number 514 710 0015/HD   MCM0101HD Replace in pairs only Required quantity 1 reinforced version</p>			
<p><b>References</b></p> <p>Volvo 31378282 Volvo 31387282 Volvo 31406349 Volvo 31476223</p>			
<p><b>Application info</b></p> <p>Volvo S60 I / V70 II (11/99-04/10) Volvo S80 II (03/06-12/16) Volvo V70 III (04/07--) Volvo XC60 I (05/08-12/17) Volvo XC70 II (04/07-12/16)</p>			
Mount, control arm		514 710 0016	MCM0153
<p><b>Notes</b></p> <p>Rear Axle Left with holder</p> <p>Outer Diameter [mm] 90 Paired article number 514 710 0015   MCM0101 Required quantity 1 replacement in pairs recommended</p>			
<p><b>References</b></p> <p>Volvo 31378282 Volvo 31387282 Volvo 31406349 Volvo 31476223</p>			
<p><b>Application info</b></p> <p>Volvo S60 I / V70 II (11/99-04/10) Volvo S80 II (03/06-12/16) Volvo V70 III (04/07--) Volvo XC60 I (05/08-12/17) Volvo XC70 II (04/07-12/16)</p>			

**Mount, control arm** **53-14 610 0002** **MCB0546**

**Notes**

Front  
 Front Axle Left  
 Front Axle Right  
 without holder

Height [mm] 65  
 Inner Diameter [mm] 14  
 Outer Diameter [mm] 45  
 Required quantity 2  
 replacement in pairs recommended



**References**

Land Rover RBX101160

Land Rover RBX101790

**Application info**

Land Rover Freelander I (02/98-10/06)

**Mount, control arm** **53-14 610 0003/HD** **MCM0173HD**

**Notes**

Carbon Neutral  
 Front Axle Left  
 Front Axle Right  
 Rear  
 for control arm  
 with holder

Inner Diameter [mm] 22  
 Replace in pairs only  
 Required quantity 2  
 reinforced version



**References**

Jaguar J9C13931	Jaguar J9C13932
Jaguar J9C19214	Jaguar J9C19215
Jaguar J9C2115	Jaguar J9C2117
Jaguar J9C33A053AC	Jaguar J9C33A053AD
Jaguar J9C33A053AE	Land Rover FK723A053AD
Land Rover FK723A053AE	Land Rover FK723A053AF
Land Rover FK723A053AH	Land Rover FK723A053AJ
Land Rover FK723A053AK	Land Rover J9C33A053AB
Land Rover J9C33A053AC	Land Rover J9C33A053AD
Land Rover J9C33A053AE	Land Rover LR024472
Land Rover LR024473	Land Rover LR045802
Land Rover LR045803	Land Rover LR060046
Land Rover LR060047	Land Rover LR073521
Land Rover LR073522	Land Rover LR078656
Land Rover LR078657	Land Rover LR086107
Land Rover LR086108	Land Rover LR096362
Land Rover LR096363	Land Rover LR101811
Land Rover LR101812	Land Rover LR104885
Land Rover LR110277	Land Rover LR110278
Land Rover LR110313	Land Rover LR115123
Land Rover LR117140	Land Rover LR117141
Land Rover LR126118	Land Rover LR126119

**Application info**

Jaguar E-Pace (X540) (09/17--)	Land Rover Discovery Sport (09/14--)
Land Rover Range Rover Evoque I (06/11-12/19)	

**Mount, control arm**

53-14 610 0012/HD

MCM0174HD

**Notes**

Carbon Neutral  
 Front Axle Right  
 Lower  
 Rear  
 with holder  
 Inner Diameter [mm] 22  
 Paired article number 53-14 610 0013/HD | MCM0175HD  
 Replace in pairs only  
 Required quantity 1  
 reinforced version



**References**

Land Rover LR002624	Land Rover LR007205
---------------------	---------------------

**Application info**

Land Rover Freelander II (10/06-12/15)

**Mount, control arm**

53-14 610 0013/HD

MCM0175HD

**Notes**

Carbon Neutral  
Front Axle Left  
Lower  
Rear  
with holder

Inner Diameter [mm]  
Paired article number  
Replace in pairs only  
Required quantity  
reinforced version

22  
53-14 610 0012/HD | MCM0174HD  
1



**References**

Land Rover LR002625

Land Rover LR007206

**Application info**

Land Rover Freelander II (10/06-12/15)

**Mount, control arm**

53-14 610 0030

MCB0559

**Notes**

Front  
Front Axle Left  
Front Axle Right  
Lower  
without holder

Height [mm]  
Inner Diameter [mm]  
Outer Diameter [mm]  
Required quantity  
replacement in pairs recommended

64  
14  
60  
2



**References**

- |                        |                        |
|------------------------|------------------------|
| Jaguar J9C13931        | Jaguar J9C13932        |
| Jaguar J9C19214        | Jaguar J9C19215        |
| Jaguar J9C2115         | Jaguar J9C2117         |
| Jaguar J9C33A053AC     | Jaguar J9C33A053AD     |
| Jaguar J9C33A053AE     | Land Rover FK723A053AD |
| Land Rover FK723A053AE | Land Rover FK723A053AF |
| Land Rover FK723A053AH | Land Rover FK723A053AJ |
| Land Rover FK723A053AK | Land Rover J9C33A053AB |
| Land Rover J9C33A053AC | Land Rover J9C33A053AD |
| Land Rover J9C33A053AE | Land Rover LR024472    |
| Land Rover LR024473    | Land Rover LR045802    |
| Land Rover LR045803    | Land Rover LR060046    |
| Land Rover LR060047    | Land Rover LR073521    |
| Land Rover LR073522    | Land Rover LR078656    |
| Land Rover LR078657    | Land Rover LR086107    |
| Land Rover LR086108    | Land Rover LR096362    |
| Land Rover LR096363    | Land Rover LR101811    |
| Land Rover LR101812    | Land Rover LR104885    |
| Land Rover LR110277    | Land Rover LR110278    |
| Land Rover LR110313    | Land Rover LR115123    |
| Land Rover LR117140    | Land Rover LR117141    |
| Land Rover LR126118    | Land Rover LR126119    |

**Application info**

- |   |                                      |
|---|--------------------------------------|
| Jaguar E-Pace (X540) (09/17--)                | Land Rover Discovery Sport (09/14--) |
| Land Rover Range Rover Evoque I (06/11-12/19) |                                      |

**Mount, control arm**

53-14 710 0000

MCM0124

**Notes**

- Rear Axle Left
- Rear Axle Right
- Upper
- without holder

- |                                  |    |
|----------------------------------|----|
| Height [mm]                      | 62 |
| Inner Diameter [mm]              | 13 |
| Outer Diameter [mm]              | 47 |
| Required quantity                | 2  |
| replacement in pairs recommended |    |



**References**

- |                      |                      |
|----------------------|----------------------|
| Land Rover RHF500031 | Land Rover RHF500100 |
|----------------------|----------------------|

**Application info**

Land Rover Discovery III (07/04-09/09)  
 Land Rover Range Rover Sport I (02/05-03/13)

Land Rover Discovery IV (09/09-12/18)

**Mount, control arm**

53-14 710 0027

MCB0569

**Notes**

Rear Axle Left  
 Rear Axle Right  
 Rubber/Metal  
 inner  
 outer  
 without holder

Height [mm] 62  
 Inner Diameter [mm] 14.2  
 Outer Diameter [mm] 47  
 Required quantity 4  
 replacement in pairs recommended



**References**

Land Rover CPLA5500BA  
 Land Rover LR139241

Land Rover LR037690

**Application info**

Land Rover Discovery V (09/16--)  
 Land Rover Range Rover Sport II (04/13--)

Land Rover Range Rover IV (08/12--)

**Mount, control arm**

53-14 710 0028

MCB0548

**Notes**

Rear  
 Rear Axle Left  
 Rear Axle Right  
 inner  
 outer  
 without holder

Height [mm] 62  
 Inner Diameter [mm] 12  
 Outer Diameter [mm] 45  
 Required quantity 4  
 replacement in pairs recommended



**References**

Jaguar J9C1348	Jaguar J9C1717
Jaguar T2H17173	Jaguar T2H17175
Jaguar T4N3670	Jaguar T4N3671
Land Rover LR060763	Land Rover LR060768
Land Rover LR073525	Land Rover LR073526
Land Rover LR078519	Land Rover LR078520
Land Rover LR117513	

**Application info**

Jaguar E-Pace (X540) (09/17--)	Jaguar XE (X760) (03/15--)
Jaguar XF II (X260) (05/15--)	Land Rover Discovery Sport (09/14--)
Land Rover Range Rover Evoque II (12/18--)	

**Mount, control arm**

53-14 710 0031

MCB0574

**Notes**

Lower  
Rear Axle Left  
Rear Axle Right  
Rubber/Metal  
inner  
without holder

Height [mm] 90  
Inner Diameter [mm] 14.1  
Outer Diameter [mm] 50.6  
Required quantity 2  
replacement in pairs recommended



**References**

Jaguar J9C18608	Jaguar J9C18609
Jaguar J9C4820	Jaguar J9C4821
Land Rover LR068166	Land Rover LR068167
Land Rover LR097278	Land Rover LR097279
Land Rover LR125868	Land Rover LR125871

**Application info**

Jaguar E-Pace (X540) (09/17--)	Land Rover Discovery Sport (09/14--)
--------------------------------	--------------------------------------

## Mount, control arm

53-16 610 0004/HD

MCB0570HD

## Notes

Carbon Neutral  
 Front Axle Left  
 Front Axle Right  
 Rubber/Metal  
 Upper  
 without holder

Height [mm] 53  
 Inner Diameter [mm] 10  
 Outer Diameter [mm] 46  
 Quantity per axle 4  
 Replace in pairs only  
 Required quantity 2



## References

Jaguar T2H3192  
 Jaguar T4N7752  
 Land Rover T4A41755

Jaguar T2H3193  
 Land Rover T4A41754

## Application info

Jaguar F-Pace (X761) (09/15--)  
 Jaguar XF II (X260) (05/15--)

Jaguar XE (X760) (03/15--)  
 Land Rover Range Rover Velar (03/17--)

## Mount, control arm

57-14 610 0002

MCB0437

## Notes

Front  
 Front Axle Left  
 Front Axle Right  
 inner  
 without holder

Height [mm] 80  
 Inner Diameter [mm] 16.5  
 Outer Diameter [mm] 55.1  
 Required quantity 2  
 replacement in pairs recommended



## References

Jeep 52089980AD  
 Jeep 52089980AG  
 Jeep 52089981AD  
 Jeep 52089981AG

Jeep 52089980AF  
 Jeep 52089980AI  
 Jeep 52089981AF  
 Jeep 52089981AI



**Application info**

Jeep Commander (XK) (09/05-12/10)

Jeep Grand Cherokee (WH) (10/04-10/11)

**Mount, control arm**

57-14 610 0003

MCB0438

**Notes**

Centre  
Front Axle Left  
Front Axle Right  
outer  
without holder

Height [mm] 70  
Inner Diameter [mm] 16  
Outer Diameter [mm] 49.5  
Required quantity 4  
replacement in pairs recommended



**References**

Jeep 52089980AD  
Jeep 52089980AG  
Jeep 52089981AD  
Jeep 52089981AG

Jeep 52089980AF  
Jeep 52089980AI  
Jeep 52089981AF  
Jeep 52089981AI

**Application info**

Jeep Commander (XK) (09/05-12/10)

Jeep Grand Cherokee (WH) (10/04-10/11)

**Mount, control arm**

57-14 610 0004

MCB0568

**Notes**

Front  
Rear  
Rear Axle Left  
Rear Axle Right  
without holder

Height [mm] 66.5  
Inner Diameter [mm] 14.4  
Outer Diameter [mm] 52  
Required quantity 4  
replacement in pairs recommended



**References**

Jeep 52060021AD  
Jeep 52060021AF  
Jeep K52060021AE

Jeep 52060021AE  
Jeep K52060021AD  
Jeep K52060021AF

**Application info**

Jeep Wrangler (JK) (06/06--)

**Mount, control arm**

614 035 0018

MCB0300

**Notes**

Front  
 Front Axle Left  
 Front Axle Right  
 Lower  
 without holder

Height [mm] 60  
 Inner Diameter [mm] 12  
 Outer Diameter [mm] 36  
 Required quantity 2  
 replacement in pairs recommended

**References**

Chevrolet 90498738

Fiat 51748653

Opel 03 52 364

Saab 45 66 899

Vauxhall 3 52 364

Fiat 51748652

GENERAL MOTORS 90498738

Opel 3 52 364

Vauxhall 03 52 364

**Application info**

Chevrolet Zafira (F75) (02/99-12/12)

Opel Astra G / Astra Classic / Zafira A (02/98-12/09)

Opel Astra J (12/06--)

Opel Vectra B (09/95-07/04)

Saab 9-3 (YS3F) (09/02-02/15)

Saab 9-5 (YS3G) (01/10-01/12)

Vauxhall Astra Mk V (01/04--)

Vauxhall Meriva Mk II B (06/10--)

Vauxhall Vectra Mk II / Signum (01/00-05/09)

Vauxhall Zafira Mk II (04/05-11/14)

Fiat Croma II (06/05--)

Opel Astra H / Zafira B (01/04-05/19)

Opel Meriva B (06/10-03/17)

Opel Vectra C / Signum (04/02-01/09)

Saab 9-5 (YS3E) (09/97-12/09)

Vauxhall Astra Mk IV (01/93-08/06)

Vauxhall Insigna Mk I A (07/08-05/17)

Vauxhall Vectra Mk I (08/95-07/03)

Vauxhall Zafira Mk I (11/98-08/05)

**Mount, control arm** **614 035 0027** **MCB0301**

**Notes**

Front Axle Left  
 Front Axle Right  
 Lower  
 Rear  
 without holder

Height [mm] 46  
 Inner Diameter [mm] 12  
 Outer Diameter [mm] 60  
 Required quantity 2  
 replacement in pairs recommended



**References**

GENERAL MOTORS 13138151  
 Opel 03 52 310  
 Opel 3 52 310  
 Vauxhall 03 52 310  
 Vauxhall 3 52 310

GENERAL MOTORS 24430103  
 Opel 03 52 320  
 Opel 3 52 320  
 Vauxhall 03 52 320  
 Vauxhall 3 52 320

**Application info**

Opel Corsa C / Combo / Tigra (09/00--)  
 Vauxhall Combo Mk II (09/01-02/12)  
 Vauxhall Meriva Mk I A (01/03-06/10)

Opel Meriva A (05/03-05/10)  
 Vauxhall Corsa Mk II / Tigra / Combo (08/00-02/12)

**Mount, control arm** **614 035 0033** **MCB0302**

**Notes**

Front  
 Front Axle Left  
 Front Axle Right  
 Lower  
 with accessories  
 with holder

Height [mm] 70  
 Inner Diameter [mm] 12  
 Outer Diameter [mm] 59  
 Required quantity 2  
 replacement in pairs recommended



**References**

GENERAL MOTORS 9199576  
 GENERAL MOTORS 93188302  
 Opel 03 52 309  
 Opel 03 52 377  
 Opel 3 52 309  
 Opel 3 52 377  
 Vauxhall 03 52 309  
 Vauxhall 03 52 377  
 Vauxhall 3 52 309  
 Vauxhall 3 52 377

GENERAL MOTORS 9199961  
 GENERAL MOTORS 93188303  
 Opel 03 52 366  
 Opel 03 52 378  
 Opel 3 52 366  
 Opel 3 52 378  
 Vauxhall 03 52 366  
 Vauxhall 03 52 378  
 Vauxhall 3 52 366  
 Vauxhall 3 52 378

**Application info**

Opel Corsa C / Combo / Tigra (09/00--)  
 Vauxhall Combo Mk II (09/01-02/12)  
 Vauxhall Meriva Mk I A (01/03-06/10)

Opel Meriva A (05/03-05/10)  
 Vauxhall Corsa Mk II / Tigra / Combo (08/00-02/12)

**Mount, control arm****614 610 0001/HD****MCB0306HD****Notes**

Carbon Neutral  
 Front Axle Left  
 Front Axle Right  
 Lower  
 Rear  
 without holder

Height [mm] 60  
 Inner Diameter [mm] 12  
 Outer Diameter [mm] 46  
 Replace in pairs only  
 Required quantity 2  
 reinforced version

**References**

Chevrolet 24439582  
 Opel 03 52 324  
 Vauxhall 03 52 324

GENERAL MOTORS 24439582  
 Opel 3 52 324  
 Vauxhall 3 52 324

**Application info**

Chevrolet Zafira (F75) (02/99-12/12)  
 Opel Astra H / Zafira B (01/04-05/19)  
 Opel Meriva B (06/10-03/17)  
 Vauxhall Astra Mk V (01/04--)  
 Vauxhall Meriva Mk II B (06/10--)  
 Vauxhall Zafira Mk II (04/05-11/14)

Opel Astra G / Astra Classic / Zafira A (02/98-12/09)  
 Opel Astra J (12/06--)  
 Vauxhall Astra Mk IV (01/93-08/06)  
 Vauxhall Insignia Mk I A (07/08-05/17)  
 Vauxhall Zafira Mk I (11/98-08/05)

**Mount, control arm**

614 610 0005

MCB0307

**Notes**

Front  
Front Axle Left  
Front Axle Right  
Lower  
without holder

Height [mm] 79  
Inner Diameter [mm] 28  
Outer Diameter [mm] 55  
Required quantity 2  
replacement in pairs recommended



**References**

GENERAL MOTORS 9160394  
Opel 45 00 094  
Renault 7700302439

Nissan 54570-00QAA  
Renault 7700302122  
Vauxhall 45 00 094

**Application info**

Nissan Interstar I (X70) (04/02--)  
Renault Master II (03/98--)

Opel Movano A (07/98--)  
Vauxhall Movano Mk I (10/98-12/10)

**Mount, control arm**

614 610 0006

MCB0308

**Notes**

Front Axle Left  
Front Axle Right  
Lower  
Rear  
without holder

Height [mm] 79  
Inner Diameter [mm] 28  
Outer Diameter [mm] 55  
Required quantity 2  
replacement in pairs recommended



**References**

GENERAL MOTORS 9160395  
Opel 45 00 095  
Renault 7700302440

Nissan 54423-00QAA  
Renault 7700302123  
Vauxhall 45 00 095

**Application info**

Nissan Interstar I (X70) (04/02--)  
Renault Master II (03/98--)

Opel Movano A (07/98--)  
Vauxhall Movano Mk I (10/98-12/10)

**Mount, control arm** **614 610 0014** **MCB0313**

**Notes**

Front  
 Front Axle Left  
 Front Axle Right  
 without holder

Height [mm] 60  
 Inner Diameter [mm] 14  
 Outer Diameter [mm] 38  
 Required quantity 2  
 replacement in pairs recommended



**References**

- |                         |                         |
|-------------------------|-------------------------|
| Chevrolet 96819161      | Chevrolet 96819162      |
| GENERAL MOTORS 20946157 | GENERAL MOTORS 20946158 |
| GENERAL MOTORS 25995128 | GENERAL MOTORS 25995129 |
| GENERAL MOTORS 96626235 | GENERAL MOTORS 96626236 |
| GENERAL MOTORS 96819161 | GENERAL MOTORS 96819162 |
| Opel 47 17 777          | Opel 48 02 540          |
| Opel 48 02 541          | Opel 48 06 300          |
| Opel 48 06 301          | Opel 48 10 831          |
| Opel 48 10 870          | Opel 48 12 870          |
| Opel 48 17 777          | Opel 48 17 778          |
| Vauxhall 48 02 540      | Vauxhall 48 02 541      |
| Vauxhall 48 06 300      | Vauxhall 48 06 301      |
| Vauxhall 48 10 831      | Vauxhall 48 10 870      |
| Vauxhall 48 17 778      |                         |

**Application info**

Chevrolet Captiva I (06/06--)  
 Vauxhall Antara (08/06--)  
 Opel Antara (05/06--)

**Mount, control arm** **614 610 0015** **MCM0106**

**Notes**

Front Axle Left  
 Front Axle Right  
 Rear  
 with holder

Height [mm] 55  
 Inner Diameter [mm] 19  
 Required quantity 2  
 replacement in pairs recommended



**References**

Chevrolet 96809676	GENERAL MOTORS 20946159
GENERAL MOTORS 25995127	GENERAL MOTORS 96809676
Opel 48 02 543	Opel 48 17 776
Opel 48 17 869	Opel 48 20 932
Vauxhall 48 02 543	Vauxhall 48 17 776
Vauxhall 48 17 869	

**Application info**

Chevrolet Captiva I (06/06--)	Opel Antara (05/06--)
Vauxhall Antara (08/06--)	

**Mount, control arm****614 610 0016****MCB0529****Notes**

Front Axle Left  
 Front Axle Right  
 Rear  
 without holder

Height [mm]	70
Inner Diameter [mm]	12
Outer Diameter [mm]	64
Required quantity	2
replacement in pairs recommended	

**References**

Chevrolet 94540668	Chevrolet 94540669
Chevrolet 94540670	GENERAL MOTORS 94540668
GENERAL MOTORS 94540669	GENERAL MOTORS 94540670
GENERAL MOTORS 95025704	GENERAL MOTORS 95025705
GENERAL MOTORS 95025706	Opel 3 52 522
Opel 3 52 523	Opel 3 52 524
Opel 3 52 551	Opel 3 52 552
Opel 3 52 553	Vauxhall 3 52 522
Vauxhall 3 52 523	Vauxhall 3 52 524
Vauxhall 3 52 552	Vauxhall 94 54 0668
Vauxhall 94 54 0669	Vauxhall 94 54 0670

**Application info**

Chevrolet Trax (12/12--)	Opel Mokka A (06/12--)
Vauxhall Mokka A (06/12--)	

**Mount, control arm**

614 610 0017

MCB0530

**Notes**

Front  
Front Axle Left  
Front Axle Right  
without holder

Height [mm] 69  
Inner Diameter [mm] 12  
Outer Diameter [mm] 37.4  
Required quantity 2  
replacement in pairs recommended



**References**

- |                         |                         |
|-------------------------|-------------------------|
| Chevrolet 94540668      | Chevrolet 94540669      |
| Chevrolet 94540670      | GENERAL MOTORS 94540668 |
| GENERAL MOTORS 94540669 | GENERAL MOTORS 94540670 |
| GENERAL MOTORS 95025704 | GENERAL MOTORS 95025705 |
| GENERAL MOTORS 95025706 | Opel 3 52 522           |
| Opel 3 52 523           | Opel 3 52 524           |
| Opel 3 52 551           | Opel 3 52 552           |
| Opel 3 52 553           | Vauxhall 3 52 522       |
| Vauxhall 3 52 523       | Vauxhall 3 52 524       |
| Vauxhall 3 52 552       | Vauxhall 94 54 0668     |
| Vauxhall 94 54 0669     | Vauxhall 94 54 0670     |

**Application info**

- |                            |                        |
|----------------------------|------------------------|
| Chevrolet Trax (12/12--)   | Opel Mokka A (06/12--) |
| Vauxhall Mokka A (06/12--) |                        |

**Mount, control arm**

614 610 0020

MCM0155

**Notes**

Front Axle Left  
Front Axle Right  
Hydro Mount  
with fastening material  
with holder

Height [mm] 64  
Inner Diameter [mm] 23  
Required quantity 2  
replacement in pairs recommended





**References**

GENERAL MOTORS 13334021  
 GENERAL MOTORS 20835938  
 Opel 03 52 494  
 Opel 3 52 491  
 Opel 3 52 508  
 Vauxhall 3 52 491  
 Vauxhall 3 52 508

GENERAL MOTORS 13371815  
 Opel 03 52 491  
 Opel 13230774  
 Opel 3 52 494  
 Vauxhall 13 23 0774  
 Vauxhall 3 52 494

**Application info**

Chevrolet Cruze (J300, J305) (07/00--)  
 Chevrolet Volt (04/11--)  
 Opel Astra J (12/06--)  
 Opel Zafira C (Tourer) (10/11--)  
 Vauxhall Astra Mk V (01/04--)  
 Vauxhall Cascada (02/13--)

Chevrolet Cruze (J308) (08/12--)  
 Opel Ampera (11/11-03/15)  
 Opel Cascada (03/13-04/19)  
 Vauxhall Ampera (03/12--)  
 Vauxhall Astra Mk VI (12/09-10/15)  
 Vauxhall Zafira Mk III (10/11-08/18)

**Mount, control arm****614 610 0022****MCM0186****Notes**

Front Axle Left  
 Front Axle Right  
 Lower  
 Rear  
 with holder  
 Height [mm] 60  
 Inner Diameter [mm] 22  
 Paired article number 614 610 0023  
 Required quantity 2  
 replacement in pairs recommended

**References**

GENERAL MOTORS 84198832  
 Opel 84198832  
 Vauxhall 84 19 8832

GENERAL MOTORS 84198833  
 Opel 84198833  
 Vauxhall 84 19 8833

**Application info**

Opel Insignia B (03/17--)

Vauxhall Insignia Mk II B (03/17--)

**Mount, control arm**

614 610 0026

MCM0187

**Notes**

Front Axle Left  
Front Axle Right  
Rear  
with holder

Height [mm] 56.5  
Inner Diameter [mm] 20  
Required quantity 2  
replacement in pairs recommended



**References**

GENERAL MOTORS 39001027  
Vauxhall 39 00 1027

Opel 39001027

**Application info**

Opel Astra K (06/15--)

Vauxhall Astra Mk VII (07/15--)

**Mount, control arm**

70-14 610 0006/HD

MCB0575HD

**Notes**

Carbon Neutral  
Front Axle Left  
Front Axle Right  
Rubber/Metal  
Upper  
for control arm  
inner  
without holder

Height [mm] 50  
Inner Diameter [mm] 56  
Outer Diameter [mm] 45  
Quantity per axle 4  
Replace in pairs only  
Required quantity 2  
reinforced version



**References**

TESLA 1044321-00-F  
TESLA 1044321-00-H  
TESLA 1044326-00-F  
TESLA 1044326-00-H

TESLA 1044321-00-G  
TESLA 1044321-00-J  
TESLA 1044326-00-G  
TESLA 1044326-00-J

**Application info**

TESLA Model 3 (01/17--)

TESLA Model Y (03/19--)

**Mount, control arm**

70-14 710 0020

MAB0229

**Notes**

Molecular Bearing  
Rear Axle Left  
Rear Axle Right  
Rubber/Metal

Height [mm]

64

Inner Diameter [mm]

14

Outer Diameter [mm]

47

Required quantity

2

replacement in pairs recommended

**References**

TESLA 1021418-00-C

TESLA 1027426-00-A

TESLA 1027426-00-C

TESLA 1043964-00-C

TESLA 1044411-00-F

TESLA 1044411-00-G

TESLA 1044416-00-F

TESLA 1044416-00-G

TESLA 6606840-00-B

**Application info**

TESLA Model 3 (01/17--)

TESLA Model S (09/12--)

TESLA Model X (09/13--)

TESLA Model Y (03/19--)

**Mount, control arm**

70-14 710 0021

MCM0213

**Notes**

Centre  
Rear Axle Left  
Rear Axle Right  
Upper  
for control arm  
without holder

Height [mm]

48

Inner Diameter [mm]

14.2

Outer Diameter [mm]

46.8

Required quantity

2

replacement in pairs recommended

**References**

TESLA 1188423-00-A

**Application info**

TESLA Model 3 (01/17--)

TESLA Model Y (03/19--)

**Mount, control arm**

714 006 0002

MCM0108

**Notes**

Front Axle Left  
 Front Axle Right  
 Lower  
 Rear  
 with holder

Height [mm] 65  
 Inner Diameter [mm] 22  
 Required quantity 2  
 replacement in pairs recommended



**References**

Ford 1 067 918  
 Ford 98AZ-3069-AA

Ford 98AG-3A262-AG

**Application info**

Ford Focus I (08/98-11/09)

**Mount, control arm**

714 010 0001

MCB0315

**Notes**

Front  
 Front Axle Left  
 Front Axle Right  
 Lower  
 without holder

Height [mm] 45.5  
 Inner Diameter [mm] 12  
 Outer Diameter [mm] 54  
 Required quantity 2  
 replacement in pairs recommended



**References**

Ford 1 102 950

Ford 6 870 549

**Application info**

Ford Mondeo I, II (01/93-09/00)

**Mount, control arm**

714 101 0001

MCB0317

**Notes**

Front  
Front Axle Left  
Front Axle Right  
Lower  
without holder

Height [mm] 62  
Inner Diameter [mm] 12  
Outer Diameter [mm] 37  
Required quantity 2  
replacement in pairs recommended



**References**

Ford 1 010 037 Ford 1 055 191  
Ford 96FB-3063-AB Ford 98FB-3063-AA  
Mazda 1E00-34-153A

**Application info**

Ford Fiesta IV / Puma (08/95--)  
Mazda 121 (JASM, JBSM) (01/96-04/03)

**Mount, control arm**

714 101 0002

MCB0318

**Notes**

Front Axle Left  
Front Axle Right  
Lower  
Rear  
without holder

Height [mm] 50  
Inner Diameter [mm] 12  
Outer Diameter [mm] 66  
Required quantity 2  
replacement in pairs recommended



**References**

Ford 1 004 011 Ford 1 014 654  
Ford 1 063 372 Ford 1 836 215  
Ford 96FB-3A262-AD Ford 98FB-3A262-AA  
Mazda 1E00-34 153 Mazda 1E01-34-153A

**Application info**

Ford Fiesta IV / Puma (08/95--)  
Mazda 121 (JASM, JBSM) (01/96-04/03)

## Mount, control arm

714 103 0001/HD

MCB0320HD

## Notes

Carbon Neutral  
 Front Axle Left  
 Front Axle Right  
 Lower  
 Rear  
 without holder

Height [mm] 46  
 Inner Diameter [mm] 12  
 Outer Diameter [mm] 54  
 Replace in pairs only  
 Required quantity 2  
 reinforced version



## References

Ford 1 035 929  
 Ford 91AB-3063-AA

Ford 89FB-3A262-AC  
 Ford 91AB-3A262-AA

## Application info

Ford Escort V, VI, VII / Orion III (01/90-10/02)  
 Ford KA I (09/96-11/08)

Ford Fiesta III (01/89-01/97)

## Mount, control arm

714 502 0001

MCB0323

## Notes

Front Axle Left  
 Front Axle Right  
 Lower  
 outer  
 without holder

Height [mm] 20  
 Inner Diameter [mm] 16.2  
 Outer Diameter [mm] 46  
 Required quantity 2  
 replacement in pairs recommended



**References**

Ford 1 637 183	Ford 5 021 458
Ford 5 021 459	Ford 5 021 464
Ford 5 021 465	Ford 5 021 661
Ford 50214-58EBJ-20	Ford 6 107 025
Ford 6 154 287	Ford 6 154 288
Ford 6 154 290	Ford 6 194 368
Ford 6 194 370	Ford 81AB-5K897-BA
Ford 85GB-3079-AB	Ford 85GB-3A052-AD
Ford 85GB-3A052-AE	Ford 85GB-3A053-AD
Ford 85GB-3A053-AE	Ford 86AB-3078A-2A
Ford 880X-3B376-CA	Ford 880X-3B376-FA
Ford 880X-3B377-CA	Ford 880X-3B377-FA
Ford 880X-5K897-AA	

**Application info**

Ford Escort III, IV / Orion I, II (09/80-10/94)

**Mount, control arm**

714 610 0002

MCB0325

**Notes**

Front Axle Left  
 Front Axle Right  
 Lower  
 Rear  
 without holder

Height [mm]	72
Inner Diameter [mm]	16
Outer Diameter [mm]	66
Required quantity	2
replacement in pairs recommended	



**References**

Ford 1 495 717	Ford 4 042 024
Ford 4 372 132	Ford 4 540 787
Ford 6C16-3A262-AA	Ford YC15-3A262-AD
Ford YC15-3A262-AE	Ford YC15-3A262-AF

**Application info**

Ford Transit '00 (01/00-05/06)	Ford Transit '06 (04/06-12/14)
--------------------------------	--------------------------------

**Mount, control arm** **714 610 0003** **MCB0326**

**Notes**

Front  
 Front Axle Left  
 Front Axle Right  
 Lower  
 without holder

Height [mm] 67  
 Inner Diameter [mm] 14  
 Outer Diameter [mm] 37  
 Required quantity 2  
 replacement in pairs recommended



**References**

Ford 1 495 713 Ford 4 041 450  
 Ford 4 131 788 Ford 6C16-3069-AA  
 Ford YC15-3069-AF Ford YC15-3069-AG

**Application info**

Ford Transit '00 (01/00-05/06) Ford Transit '06 (04/06-12/14)

**Mount, control arm** **714 610 0004** **MCB0327**

**Notes**

Front  
 Front Axle Left  
 Front Axle Right  
 Lower  
 without holder

Height [mm] 55  
 Inner Diameter [mm] 12  
 Outer Diameter [mm] 41  
 Required quantity 2  
 replacement in pairs recommended





**References**

Ford 1 146 130	Ford 1 146 131
Ford 1 207 447	Ford 1 207 448
Ford 1 211 757	Ford 1 212 807
Ford 1 212 808	Ford 1 214 911
Ford 1 214 912	Ford 1 436 095
Ford 1 436 097	Ford 1 436 169
Ford 1 436 170	Ford 1 706 970
Ford 1 706 971	Ford 2N11-3042-AE
Ford 2N11-3042-AH	Ford 2N11-3051-AE
Ford 2N11-3051-AG	Ford 2N11-3051-AH
Ford 2S61-3042-AD	Ford 2S61-3042-AH
Ford 2S61-3042-AJ	Ford 2S61-3042-AK
Ford 2S61-3042-DA	Ford 2S61-3051-AD
Ford 2S61-3051-AH	Ford 2S61-3051-AJ
Ford 2S61-3051-AK	Ford 2S61-3051-DA
Mazda DD32-34-300	Mazda DD32-34-350

**Application info**

Ford Fiesta V / Fusion (11/01-12/14)	Mazda 2 (DY) (02/03-06/07)
--------------------------------------	----------------------------

**Mount, control arm**

714 610 0005

MCM0109

**Notes**

Front Axle Left  
 Front Axle Right  
 Rear  
 with holder  
 2

Required quantity  
 replacement in pairs recommended



**References**

Ford 1 146 130	Ford 1 146 131
Ford 1 207 447	Ford 1 207 448
Ford 1 211 757	Ford 1 212 807
Ford 1 212 808	Ford 1 214 911
Ford 1 214 912	Ford 1 436 095
Ford 1 436 097	Ford 1 436 169
Ford 1 436 170	Ford 1 706 970
Ford 1 706 971	Ford 2N11-3042-AE
Ford 2N11-3042-AH	Ford 2N11-3051-AE
Ford 2N11-3051-AG	Ford 2N11-3051-AH
Ford 2S61-3042-AD	Ford 2S61-3042-AH
Ford 2S61-3042-AJ	Ford 2S61-3042-AK
Ford 2S61-3042-DA	Ford 2S61-3051-AD
Ford 2S61-3051-AH	Ford 2S61-3051-AJ
Ford 2S61-3051-AK	Ford 2S61-3051-DA
Mazda DD32-34-300	Mazda DD32-34-350

**Application info**

Ford Fiesta V / Fusion (11/01-12/14)	Mazda 2 (DY) (02/03-06/07)
--------------------------------------	----------------------------

**Mount, control arm**

714 610 0007

MCB0328

**Notes**

Front Axle Left  
 Front Axle Right  
 Lower  
 Rear  
 without holder

Height [mm] 65  
 Inner Diameter [mm] 22  
 Required quantity 2  
 replacement in pairs recommended



**References**

Ford 1 332 454	Ford 1 332 455
Ford 1 355 048	Ford 1 355 050
Ford 2T14-3042-BF	Ford 2T14-3042-BH
Ford 2T14-3042-BJ	Ford 2T14-3051-BF
Ford 2T14-3051-BH	Ford 4 366 973
Ford 4 366 974	Ford 4 539 871
Ford 4T16-3042-AA	Ford 4T16-3051-AA

**Application info**

Ford Tourneo '02 (06/02-12/13)	Ford Transit '02 (06/02--)
--------------------------------	----------------------------

## Mount, control arm

714 610 0008

MCB0329

## Notes

Front  
 Front Axle Left  
 Front Axle Right  
 Lower  
 without holder

Height [mm] 65  
 Inner Diameter [mm] 14  
 Outer Diameter [mm] 40  
 Required quantity 2  
 replacement in pairs recommended



## References

Ford 2T14-3063-AA

Ford 4 366 976

## Application info

Ford Tourneo '02 (06/02-12/13)

Ford Transit '02 (06/02--)

## Mount, control arm

714 610 0009/HD

MCB0330HD

## Notes

Carbon Neutral  
 Front Axle Left  
 Front Axle Right  
 Rear  
 without holder

Height [mm] 73  
 Inner Diameter [mm] 22  
 Replace in pairs only  
 Required quantity 2  
 Thread Size M12x1,75  
 reinforced version



## References

The references of this product can be found at [www.meyle.com](http://www.meyle.com)

## Application info

Ford C-Max I (02/07-09/10)  
 Ford Kuga I (02/08-11/12)  
 Mazda 5 (CR) (02/05-12/10)  
 Volvo C70 II (03/06-12/13)

Ford Focus II (10/03--)  
 Mazda 3 (BK) (09/99-12/09)  
 Volvo C30 (09/06-12/13)  
 Volvo S40 II / V50 (12/03-12/12)

## Mount, control arm

714 610 0011

MCB0331

## Notes

Front  
 Front Axle Left  
 Front Axle Right  
 without holder

Height [mm] 60  
 Inner Diameter [mm] 14  
 Outer Diameter [mm] 60  
 Required quantity 2  
 replacement in pairs recommended



## References

Ford 1 377 846	Ford 1 385 593
Ford 1 403 408	Ford 1 419 814
Ford 1 426 875	Ford 1 435 745
Ford 1 458 773	Ford 1 460 693
Ford 1 466 186	Ford 1 466 188
Ford 1 469 024	Ford 1 469 026
Ford 1 507 181	Ford 1 507 182
Ford 6G9N-3A052-DA	Ford 6G9N-3A052-DB
Ford 6G9N-3A052-DC	Ford 6G9N-3A052-DD
Ford 6G9N-3A052-DE	Ford 6G9N-3A052-DF
Ford 6G9N-3A052-DG	Ford 6G9N-3A052-DH
Ford 6G9N-3A053-DG	Ford 6G9N-3A053-DH
Ford 7G9N-3A052-BA	Ford 7G9N-3A052-BB
Ford 7G9N-3A053-BA	Ford 7G9N-3A053-BB
Ford (Chanagan) 1 507 181	Ford (Chanagan) 1 507 182
Land Rover LR002624	Land Rover LR002625
Land Rover LR007205	Land Rover LR007206
Volvo 30683248	Volvo 30683249
Volvo 31200775	Volvo 31200776
Volvo 31202228	Volvo 31202229
Volvo 31277345	Volvo 31277346
Volvo 31277525	Volvo 31277526
Volvo 31317663	Volvo 31317664
Volvo 31317665	Volvo 31317666
Volvo 31340127	Volvo 31340128
Volvo 31429320	Volvo 31429321

**Application info**

Ford Galaxy II (05/06-06/15)

Ford S-Max I (05/06-12/14)

Land Rover Range Rover Evoque I (06/11-12/19)

Volvo S80 II (03/06-12/16)

Volvo XC60 I (05/08-12/17)

Ford Mondeo IV (03/07-01/15)

Land Rover Freelander II (10/06-12/15)

Volvo S60 II / V60 (04/10--)

Volvo V70 III (04/07--)

Volvo XC70 II (04/07-12/16)

**Mount, control arm****714 610 0012/HD****MCM0110HD****Notes**

Carbon Neutral

Front Axle Left

Rear

with holder

22

Inner Diameter [mm]

Paired article number

714 610 0013/HD | MCM0111HD

Replace in pairs only

Required quantity

1

reinforced version

**References**

Ford 1 460 693

Ford 1 469 026

Ford 6G9N-3A053-DG

Ford 7G9N-3A053-BA

Ford (Chanagan) 7G9N-3A053-BA

Volvo 31200563

Volvo 31212782

Volvo 31277525

Volvo 31317665

Volvo 31340128

Volvo 31429321

Ford 1 466 188

Ford 1 507 182

Ford 6G9N-3A053-DH

Ford 7G9N-3A053-BB

Ford (Chanagan) 7G9N-3A053-BB

Volvo 31200776

Volvo 31277343

Volvo 31317661

Volvo 31340127

Volvo 31429320

**Application info**

Ford Galaxy II (05/06-06/15)

Ford S-Max I (05/06-12/14)

Volvo S80 II (03/06-12/16)

Volvo XC60 I (05/08-12/17)

Ford Mondeo IV (03/07-01/15)

Volvo S60 II / V60 (04/10--)

Volvo V70 III (04/07--)

Volvo XC70 II (04/07-12/16)

**Mount, control arm** **714 610 0012** **MCM0110**

**Notes**

Front Axle Left  
 Hydro Mount  
 Rear  
 with holder  
 Inner Diameter [mm] 20  
 Paired article number 714 610 0013 | MCM0111  
 Required quantity 1  
 replacement in pairs recommended



**References**

- |                               |                               |
|-------------------------------|-------------------------------|
| Ford 1 460 693                | Ford 1 466 188                |
| Ford 1 469 026                | Ford 1 507 182                |
| Ford 6G9N-3A053-DG            | Ford 6G9N-3A053-DH            |
| Ford 7G9N-3A053-BA            | Ford 7G9N-3A053-BB            |
| Ford (Chanagan) 7G9N-3A053-BA | Ford (Chanagan) 7G9N-3A053-BB |
| Volvo 31200563                | Volvo 31200776                |
| Volvo 31212782                | Volvo 31277343                |
| Volvo 31277525                | Volvo 31317661                |
| Volvo 31317665                | Volvo 31340127                |
| Volvo 31340128                | Volvo 31429320                |
| Volvo 31429321                |                               |

**Application info**

- |                              |                              |
|------------------------------|------------------------------|
| Ford Galaxy II (05/06-06/15) | Ford Mondeo IV (03/07-01/15) |
| Ford S-Max I (05/06-12/14)   | Volvo S60 II / V60 (04/10--) |
| Volvo S80 II (03/06-12/16)   | Volvo V70 III (04/07--)      |
| Volvo XC60 I (05/08-12/17)   | Volvo XC70 II (04/07-12/16)  |

**Mount, control arm** **714 610 0013** **MCM0111**

**Notes**

Front Axle Right  
 Hydro Mount  
 Rear  
 with holder  
 Inner Diameter [mm] 20  
 Paired article number 714 610 0012 | MCM0110  
 Required quantity 1  
 replacement in pairs recommended



**References**

Ford 1 377 846	Ford 1 385 593
Ford 1 403 408	Ford 1 419 814
Ford 1 426 875	Ford 1 435 745
Ford 1 458 773	Ford 1 466 186
Ford 1 469 024	Ford 1 507 181
Ford 6G9N-3A052-DG	Ford 6G9N-3A052-DH
Ford 7G9N-3A052-BA	Ford 7G9N-3A052-BB
Ford (Chanagan) 7G9N-3A052-BA	Ford (Chanagan) 7G9N-3A052-BB
Volvo 31200775	Volvo 31212781
Volvo 31277344	Volvo 31277525
Volvo 31317662	Volvo 31317666
Volvo 31340127	Volvo 31340128
Volvo 31429320	Volvo 31429321

**Application info**

Ford Galaxy II (05/06-06/15)	Ford Mondeo IV (03/07-01/15)
Ford S-Max I (05/06-12/14)	Volvo S60 II / V60 (04/10--)
Volvo S80 II (03/06-12/16)	Volvo V70 III (04/07--)
Volvo XC60 I (05/08-12/17)	Volvo XC70 II (04/07-12/16)

**Mount, control arm**

714 610 0013/HD

MCM0111HD

**Notes**

Carbon Neutral  
 Front Axle Right  
 Rear  
 with holder  
 Inner Diameter [mm] 22  
 Paired article number 714 610 0012/HD | MCM0110HD  
 Replace in pairs only  
 Required quantity 1  
 reinforced version



**References**

Ford 1 377 846	Ford 1 385 593
Ford 1 403 408	Ford 1 419 814
Ford 1 426 875	Ford 1 435 745
Ford 1 458 773	Ford 1 466 186
Ford 1 469 024	Ford 1 507 181
Ford 6G9N-3A052-DG	Ford 6G9N-3A052-DH
Ford 7G9N-3A052-BA	Ford 7G9N-3A052-BB
Ford (Chanagan) 7G9N-3A052-BA	Ford (Chanagan) 7G9N-3A052-BB
Volvo 31200775	Volvo 31212781
Volvo 31277344	Volvo 31277525
Volvo 31317662	Volvo 31317666
Volvo 31340127	Volvo 31340128
Volvo 31429320	Volvo 31429321

**Application info**

Ford Galaxy II (05/06-06/15)	Ford Mondeo IV (03/07-01/15)
Ford S-Max I (05/06-12/14)	Volvo S60 II / V60 (04/10--)
Volvo S80 II (03/06-12/16)	Volvo V70 III (04/07--)
Volvo XC60 I (05/08-12/17)	Volvo XC70 II (04/07-12/16)

**Mount, control arm**

714 610 0017

MCB0335

**Notes**

Front Axle Left  
 Front Axle Right  
 Rear  
 without holder

Height [mm] 52  
 Inner Diameter [mm] 12  
 Outer Diameter [mm] 61  
 Required quantity 2  
 replacement in pairs recommended





**References**

Ford 1 518 904	Ford 1 520 778
Ford 1 521 773	Ford 1 532 421
Ford 1 532 433	Ford 1 540 724
Ford 1 540 725	Ford 1 700 809
Ford 1 700 810	Ford 1 708 222
Ford 1 708 226	Ford 1 712 696
Ford 1 712 697	Ford 1 737 305
Ford 1 737 309	Ford 8V51-3042-BA
Ford 8V51-3042-BB	Ford 8V51-3042-BC
Ford 8V51-3042-BD	Ford 8V51-3042-BE
Ford 8V51-3042-BF	Ford 8V51-3042-BG
Ford 8V51-3042-BH	Ford 8V51-3051-BB
Ford 8V51-3051-BC	Ford 8V51-3051-BD
Ford 8V51-3051-BE	Ford 8V51-3051-BF
Ford 8V51-3051-BG	Ford 8V51-3051-BH
Mazda D651-34-300	Mazda D651-34-300B
Mazda D651-34-300C	Mazda D651-34-300D
Mazda D651-34-350	Mazda D651-34-350A
Mazda D651-34-350B	Mazda D651-34-350C
Mazda D651-34-350D	Mazda D651-34-350E

**Application info**

Ford Fiesta VI (06/08--)

Mazda 2 (DE) (07/07-06/15)

**Mount, control arm**

714 610 0019

MCB0366

**Notes**

Front Axle Left  
Front Axle Right  
without holder

Height [mm]	65
Inner Diameter [mm]	14
Outer Diameter [mm]	38
Required quantity	2
replacement in pairs recommended	

**References**The references of this product can be found at [www.meyle.com](http://www.meyle.com)**Application info**

Ford C-Max II (04/10--)  
Ford Kuga II (05/12--)  
Volvo V40 II (03/12--)

Ford Focus III (07/10--)  
Mazda 3 (BL) (12/08-12/14)

## Mount, control arm

714 610 0020

MCM0151

## Notes

Front Axle Left  
 Front Axle Right  
 Hydro Mount  
 with holder

Height [mm]

73

Inner Diameter [mm]

22

Required quantity

2

replacement in pairs recommended



## References

Ford 1 702 970

Ford 1 702 983

Ford 1 709 457

Ford 1 709 466

Ford 1 742 265

Ford 1 742 266

Ford 1 773 516

Ford 1 773 518

Ford 1 781 658

Ford 1 781 660

Ford 1 793 236

Ford 1 793 237

Ford 1 805 952

Ford 1 805 953

Ford 1 857 345

Ford 1 857 346

Ford 1 865 168

Ford 1 865 173

Ford 1 865 175

Ford 1 865 176

Ford 1 866 068

Ford 1 866 070

Ford 1 866 072

Ford 1 866 073

Ford 2 172 992

Ford 2 173 539

Ford 2 173 541

Ford 2 176 249

Ford AV61-3A423-LB

Ford AV61-3A423-LC

Ford AV61-3A424-LB

Ford AV61-3A424-LC

Ford BV61-3A423-AAB

Ford BV61-3A423-AAC

Ford BV61-3A423-AAD

Ford BV61-3A423-BAB

Ford BV61-3A423-BAC

Ford BV61-3A423-LAA

Ford BV61-3A423-LAB

Ford BV61-3A424-AAB

Ford BV61-3A424-AAC

Ford BV61-3A424-AAD

Ford BV61-3A424-BAB

Ford BV61-3A424-BAC

Ford BV61-3A424-LAA

Ford BV61-3A424-LAB

Ford CV61-3A423-AAB

Ford CV61-3A423-AAC

Ford CV61-3A424-AAB

Ford CV61-3A424-AAC

Ford F1F1-3A423-AAA

Ford F1F1-3A423-AAB

Ford F1F1-3A424-AAA

Ford F1F1-3A424-AAB

Ford F1F1-3A424-BAA

Ford F1F13-A423B-AA

Volvo 31277620

Volvo 31277621

Volvo 31340231

Volvo 31340232

**Application info**

Ford C-Max II (04/10--)  
 Ford Kuga II (05/12--)

Ford Focus III (07/10--)  
 Volvo V40 II (03/12--)

**Mount, control arm**

714 610 0020/HD

MCM0151HD

**Notes**

Carbon Neutral  
 Front Axle Left  
 Front Axle Right  
 with holder

Height [mm]

73

Inner Diameter [mm]

22

Replace in pairs only

Required quantity

2

reinforced version



**References**

Ford 1 702 970	Ford 1 702 983
Ford 1 709 457	Ford 1 709 466
Ford 1 742 265	Ford 1 742 266
Ford 1 773 516	Ford 1 773 518
Ford 1 781 658	Ford 1 781 660
Ford 1 793 236	Ford 1 793 237
Ford 1 805 952	Ford 1 805 953
Ford 1 857 345	Ford 1 857 346
Ford 1 865 168	Ford 1 865 173
Ford 1 865 175	Ford 1 865 176
Ford 1 866 068	Ford 1 866 070
Ford 1 866 072	Ford 1 866 073
Ford 2 172 992	Ford 2 173 539
Ford 2 173 541	Ford 2 176 249
Ford AV61-3A423-LB	Ford AV61-3A423-LC
Ford AV61-3A424-LB	Ford AV61-3A424-LC
Ford BV61-3A423-AAB	Ford BV61-3A423-AAC
Ford BV61-3A423-AAD	Ford BV61-3A423-BAB
Ford BV61-3A423-BAC	Ford BV61-3A423-LAA
Ford BV61-3A423-LAB	Ford BV61-3A424-AAB
Ford BV61-3A424-AAC	Ford BV61-3A424-AAD
Ford BV61-3A424-BAB	Ford BV61-3A424-BAC
Ford BV61-3A424-LAA	Ford BV61-3A424-LAB
Ford CV61-3A423-AAB	Ford CV61-3A423-AAC
Ford CV61-3A424-AAB	Ford CV61-3A424-AAC
Ford F1F1-3A423-AAA	Ford F1F1-3A423-AAB
Ford F1F1-3A424-AAA	Ford F1F1-3A424-AAB
Ford F1F1-3A424-BAA	Ford F1F13-A423B-AA
Volvo 31277620	Volvo 31277621
Volvo 31340231	Volvo 31340232

**Application info**

Ford C-Max II (04/10--)	Ford Focus III (07/10--)
Ford Kuga II (05/12--)	Volvo V40 II (03/12--)

## Mount, control arm

714 610 0020/S

MCM0165

## Notes

Front Axle Left  
 Front Axle Right  
 Hydro Mount  
 with fastening material  
 with holder

Height [mm]

73

Inner Diameter [mm]

22

Required quantity

2

replacement in pairs recommended



## References

Ford 1 702 970

Ford 1 702 983

Ford 1 709 457

Ford 1 709 466

Ford 1 742 265

Ford 1 742 266

Ford 1 773 516

Ford 1 773 518

Ford 1 781 658

Ford 1 781 660

Ford 1 793 236

Ford 1 793 237

Ford 1 805 952

Ford 1 805 953

Ford 1 857 345

Ford 1 857 346

Ford 1 865 168

Ford 1 865 173

Ford 1 865 175

Ford 1 865 176

Ford 1 866 068

Ford 1 866 070

Ford 1 866 072

Ford 1 866 073

Ford 2 172 992

Ford 2 173 539

Ford 2 173 541

Ford 2 176 249

Ford AV61-3A423-LB

Ford AV61-3A423-LC

Ford AV61-3A424-LB

Ford AV61-3A424-LC

Ford BV61-3A423-AAB

Ford BV61-3A423-AAC

Ford BV61-3A423-AAD

Ford BV61-3A423-BAB

Ford BV61-3A423-BAC

Ford BV61-3A423-LAA

Ford BV61-3A423-LAB

Ford BV61-3A424-AAB

Ford BV61-3A424-AAC

Ford BV61-3A424-AAD

Ford BV61-3A424-BAB

Ford BV61-3A424-BAC

Ford BV61-3A424-LAA

Ford BV61-3A424-LAB

Ford CV61-3A423-AAB

Ford CV61-3A423-AAC

Ford CV61-3A424-AAB

Ford CV61-3A424-AAC

Ford F1F1-3A423-AAA

Ford F1F1-3A423-AAB

Ford F1F1-3A424-AAA

Ford F1F1-3A424-AAB

Ford F1F1-3A424-BAA

Ford F1F13-A423B-AA

Volvo 31277620

Volvo 31277621

Volvo 31340231

Volvo 31340232

**Application info**

Ford C-Max II (04/10--)

Ford Kuga II (05/12--)

Ford Focus III (07/10--)

Volvo V40 II (03/12--)

**Mount, control arm**

714 610 0021/HD

MCM0131HD

**Notes**

Carbon Neutral  
 Front Axle Left  
 Front Axle Right  
 Rear  
 with fastening material  
 with holder

Height [mm]

73

Inner Diameter [mm]

22

Replace in pairs only

Required quantity

2

Thread Size

M12x1,75

reinforced version

**References**The references of this product can be found at [www.meyle.com](http://www.meyle.com)**Application info**

Ford C-Max I (02/07-09/10)

Ford Kuga I (02/08-11/12)

Mazda 5 (CR) (02/05-12/10)

Volvo C30 (09/06-12/13)

Volvo S40 II / V50 (12/03-12/12)

Ford Focus II (10/03--)

Mazda 3 (BK) (09/99-12/09)

Mazda 5 (CW) (06/10--)

Volvo C70 II (03/06-12/13)

**Mount, control arm**

714 610 0026

MCB0510

**Notes**

Front Axle Left  
 Front Axle Right  
 without holder

Height [mm]

60

Inner Diameter [mm]

16

Outer Diameter [mm]

66

Required quantity

2

replacement in pairs recommended



**References**

Ford 1 927 131	Ford 1 927 132
Ford 2 180 767	Ford 2 180 769
Ford 5 232 480	Ford 5 232 481
Ford 5 303 328	Ford 5 303 329
Ford FG9C3-A052A-NA	Ford FG9C3-A052A-NB
Ford FG9C3-A052A-NC	Ford FG9C3-A053A-NA
Ford FG9C3-A053A-NB	Ford FG9C3-A053A-NC

**Application info**

Ford Mondeo V (09/12--)

**Mount, control arm**

714 610 0027/HD

MCM0188HD

**Notes**

Carbon Neutral  
 Front Axle Left  
 with holder  
 Inner Diameter [mm] 23  
 Paired article number 714 610 0028/HD | MCM0189HD  
 Replace in pairs only  
 Required quantity 1  
 reinforced version



**References**

Ford 1 877 653	Ford 1 927 132
Ford 2 180 769	Ford 5 232 481
Ford 5 303 329	Ford DG9C-3A053-ANE
Ford E1GC3A053AEB	Ford FG9C3-A053A-NA
Ford FG9C3-A053A-NB	Ford FG9C3-A053A-NC

**Application info**

Ford Galaxy III (01/15--)	Ford Mondeo V (09/12--)
Ford S-Max II (01/15--)	

Mount, control arm

714 610 0028/HD

MCM0189HD

Notes

Carbon Neutral  
Front Axle Right  
with holder

Inner Diameter [mm]

23

Paired article number

714 610 0027/HD | MCM0188HD

Replace in pairs only

Required quantity

1

reinforced version



References

Ford 1 877 652

Ford 1 927 131

Ford 2 180 767

Ford 5 232 480

Ford 5 303 328

Ford DG9C-3A052-ANE

Ford E1GC3A052AEB

Ford FG9C3-A052A-NA

Ford FG9C3-A052A-NB

Ford FG9C3-A052A-NC

Application info

Ford Galaxy III (01/15--)

Ford Mondeo V (09/12--)

Ford S-Max II (01/15--)

Mount, control arm

714 610 0033

MCB0543

Notes

Front  
Front Axle Left  
Front Axle Right  
Lower  
inner  
without holder

Height [mm]

53

Inner Diameter [mm]

14

Outer Diameter [mm]

38

Required quantity

2

replacement in pairs recommended



References

Ford 2 084 192

Ford 2 084 194

Ford 2 112 614

Ford 2 112 616

Ford 2 201 370

Ford 2 201 372

Ford H1BC-3042-AD

Ford H1BC-3042-AE

Ford H1BC-3051-AD

Ford H1BC-3051-AE



**Application info**

Ford Fiesta VII (05/17--)

**Mount, control arm**

714 610 0034

MCB0544

**Notes**

Front Axle Left  
 Front Axle Right  
 Lower  
 Rear  
 inner  
 without holder

Height [mm] 52  
 Inner Diameter [mm] 16  
 Outer Diameter [mm] 61  
 Required quantity 2  
 replacement in pairs recommended



**References**

Ford 2 084 192	Ford 2 084 194
Ford 2 112 614	Ford 2 112 616
Ford 2 201 370	Ford 2 201 372
Ford H1BC-3042-AD	Ford H1BC-3042-AE
Ford H1BC-3051-AD	Ford H1BC-3051-AE

**Application info**

Ford Fiesta VII (05/17--)

**Mount, control arm**

714 610 0037

MCB0560

**Notes**

Front  
 Front Axle Left  
 Front Axle Right  
 Lower  
 Rubber-Metal Mount  
 Rubber/Metal  
 without holder

Height [mm] 62.5  
 Inner Diameter [mm] 18.2  
 Outer Diameter [mm] 66  
 Required quantity 2  
 replacement in pairs recommended



**References**

Ford 1 877 652

Ford E1GC3A052AEB

Ford 1 877 653

Ford E1GC3A053AEB

**Application info**

Ford Galaxy III (01/15--)

Ford S-Max II (01/15--)

**Mount, control arm**

714 610 0038/HD

MCB0563HD

**Notes**

Carbon Neutral  
 Front Axle Left  
 Front Axle Right  
 Lower  
 Rear  
 without holder

Height [mm]

65

Inner Diameter [mm]

14

Outer Diameter [mm]

78

Replace in pairs only

Required quantity

2

reinforced version

**References**

Ford 2 216 263

Ford JX61-3A262-CEA

**Application info**

Ford Focus IV (01/18--)

**Mount, control arm**

714 610 0039

MCB0553

**Notes**

Front  
 Front Axle Left  
 Front Axle Right  
 Lower  
 Rubber/Metal  
 without holder

Height [mm]

60

Inner Diameter [mm]

16.2

Outer Diameter [mm]

42

Required quantity

2

replacement in pairs recommended



**References**

Ford 2 216 265

Ford JX61-3A423-CEB

Ford 2 216 267

Ford JX61-3A424-CEB

**Application info**

Ford Focus IV (01/18--)

**Mount, control arm**

714 610 0040

MCB0554

**Notes**

Front Axle Left  
 Front Axle Right  
 Rear  
 Rubber/Metal  
 for control arm  
 without holder

Height [mm]

65

Inner Diameter [mm]

14.3

Outer Diameter [mm]

63.9

Required quantity

2

replacement in pairs recommended



**References**

Ford 2 216 261

Ford USA JX61-3A262\_AEA

Ford JX61-3A262-AEA

**Application info**

Ford Focus IV (01/18--)

**Mount, control arm**

714 687 0001

MCB0339

**Notes**

Front Axle Left  
 Front Axle Right  
 Lower  
 Rear  
 without holder

Height [mm]

46

Inner Diameter [mm]

12

Outer Diameter [mm]

60

Required quantity

2

replacement in pairs recommended



**References**

Ford 1 023 058

Ford 95BG-3A262-AA

Ford 1 074 282

Ford 95BG-3A262-BA

**Application info**

Ford Mondeo I, II (01/93-09/00)

**Mount, control arm**

714 710 0008

MCB0340

**Notes**Rear Axle Left  
Rear Axle Right  
without holder

Height [mm]

35

Inner Diameter [mm]

12

Outer Diameter [mm]

36

Required quantity

2

replacement in pairs recommended

**References**

Ford 1 041 683

Ford 1 116 608

Ford 1 220 005

Ford 1S71-5500-AA

Ford 1S71-5K743-BA

Ford 6 710 264

Ford 6 829 058

Ford 93BB-5500-AC

Ford 93BB-5500-AE

Jaguar C2S35280

Jaguar C2S9241

Ford 1 093 772

Ford 1 123 275

Ford 1 325 326

Ford 1S71-5500-AC

Ford 1S71-5K743-CA

Ford 6 829 045

Ford 93BB-5500-AB

Ford 93BB-5500-AD

Ford 93BB-5K653-AB

Jaguar C2S39484

**Application info**

Ford Cougar (08/98-12/01)

Ford Mondeo III (10/00-09/07)

Ford Mondeo I, II (01/93-09/00)

Jaguar X-Type (03/01-12/09)

**Mount, control arm**

714 710 0014

MCB0488

**Notes**

Lower  
Rear Axle Left  
Rear Axle Right  
for control arm  
inner  
without holder

Height [mm] 55  
Inner Diameter [mm] 12  
Outer Diameter [mm] 38  
Quantity per axle 2  
Required quantity 2  
replacement in pairs recommended

**References**

Ford 1 377 447

Ford 1 387 627

Ford 1 469 125

Ford 6G91-5K652-XAB

Ford 6G91-5K652-XAD

Ford 1 381 442

Ford 1 421 954

Ford 6G91-5K652-XAA

Ford 6G91-5K652-XAC

Ford 6G91-5K652-XAE

**Application info**

Ford Galaxy II (05/06-06/15)

Ford S-Max I (05/06-12/14)

Ford Mondeo IV (03/07-01/15)

**Mount, control arm**

714 710 0022

MCB0566

**Notes**

Rear Axle Left  
Rear Axle Right  
without holder

Height [mm] 40  
Inner Diameter [mm] 12  
Outer Diameter [mm] 43.5  
Required quantity 2  
replacement in pairs recommended

**References**

Ford 2 216 285

Ford JX61-5500-AEA

**Application info**

Ford Focus IV (01/18--)

**Mount, control arm**

714 710 0023

MCB0576

**Notes**

Rear Axle Left  
Rear Axle Right  
without holder

Height [mm] 40  
Inner Diameter [mm] 12  
Outer Diameter [mm] 40  
Quantity per axle 4  
Required quantity 2  
replacement in pairs recommended

**References**

Ford 2 200 527

Ford 2 428 955

Ford JX61-5K743-AEA

Ford JX61-5K743-AEB

**Application info**

Ford Focus IV (01/18--)

Ford Kuga III (07/19--)

**Repair kit, subframe**

714 710 0017/HD

MFK0037HD

**Notes**

Carbon Neutral  
Rear Axle Left  
Rear Axle Right  
with attachment material

Required quantity  
reinforced version  
replacement in pairs recommended

**References**

Ford 1 566 810

Ford 2 040 702

Ford 2 040 703

Ford 6G91-5K896-AB

Volvo 31387280

Volvo 31387281

Volvo 31406337

Volvo 31406350

Volvo 31476221

Volvo 31476222

**Application info**

Ford Galaxy II (05/06-06/15)

Ford Mondeo IV (03/07-01/15)

Ford S-Max I (05/06-12/14)

Volvo S60 II / V60 (04/10--)

Volvo S80 II (03/06-12/16)

Volvo V70 III (04/07--)

Volvo XC60 I (05/08-12/17)

Volvo XC70 II (04/07-12/16)

**Repair kit, subframe**

714 710 0017/S

MFK0029

**Notes**

Rear Axle Left  
Rear Axle Right  
with attachment material

Required quantity  
replacement in pairs recommended

2



**References**

Ford 1 566 810  
Ford 2 040 703  
Volvo 31387280  
Volvo 31406337  
Volvo 31476221

Ford 2 040 702  
Ford 6G91-5K896-AB  
Volvo 31387281  
Volvo 31406350  
Volvo 31476222

**Application info**

Ford Galaxy II (05/06-06/15)  
Ford S-Max I (05/06-12/14)  
Volvo S80 II (03/06-12/16)  
Volvo XC60 I (05/08-12/17)

Ford Mondeo IV (03/07-01/15)  
Volvo S60 II / V60 (04/10--)  
Volvo V70 III (04/07--)  
Volvo XC70 II (04/07-12/16)

**Repair kit, subframe**

714 710 0018/HD

MFK0038HD

**Notes**

Carbon Neutral  
Rear Axle Left  
Rear Axle Right  
with attachment material

Required quantity  
replacement in pairs recommended

2



**References**

Volvo 31378282  
Volvo 31387282  
Volvo 31406350  
Volvo 31476223

Volvo 31387281  
Volvo 31406349  
Volvo 31476222

**Application info**

Volvo S60 I / V70 II (11/99-04/10)

Volvo V70 III (04/07--)

Volvo XC70 II (04/07-12/16)

Volvo S80 II (03/06-12/16)

Volvo XC60 I (05/08-12/17)

**Rod/strut, suspension****53-16 060 0018****MSR0143****Notes**

Guide Rod  
 Rear Axle Left  
 Rear Axle Right  
 Steel

Length [mm] 306  
 Required quantity 2  
 Thread Size M14X1,5

Length [mm]

Required quantity

Thread Size

replacement in pairs recommended

**References**

Land Rover RGD000180

Land Rover RGD500180

Land Rover RGD500100

**Application info**

Land Rover Range Rover III (03/02-12/12)

**Rod/strut, suspension****57-16 050 0005****MSR0153****Notes**

Guide Rod  
 Rear  
 Rear Axle Left  
 Rear Axle Right

Length [mm] 567  
 Required quantity 2

Length [mm]

Required quantity

replacement in pairs recommended

**References**

Jeep 51945319

Jeep K68309199AA

Jeep 68309199AA

**Application info**

Jeep Compass (MP) (01/16--)

Jeep Renegade (BU, B1) (07/14--)



**Rod/strut, suspension** **716 035 0000** **MSR0097**

**Notes**

Guide Rod  
 Rear Axle Left  
 Rear Axle Right  
 Sheet Steel  
 Upper  
 with rubber mount

Length [mm] 286  
 Required quantity 2  
 replacement in pairs recommended



**References**

- |                   |                     |
|-------------------|---------------------|
| Ford 1 061 660    | Ford 1 136 073      |
| Ford 1 448 127    | Ford 1 502 440      |
| Ford 1M51-5500-BA | Ford 2 512 871      |
| Ford 6M51-5500-BA | Ford 8V41-5500-AA   |
| Ford 98AG-5500-BF | Ford ME6M5J-5500-BA |

**Application info**

- |                            |                         |
|----------------------------|-------------------------|
| Ford Focus I (08/98-11/09) | Ford Focus II (10/03--) |
| Ford Kuga I (02/08-11/12)  |                         |

**Rod/strut, suspension** **716 035 0005** **MSR0102**

**Notes**

Front  
 Guide Rod  
 Lower  
 Rear Axle Left  
 Rear Axle Right  
 Sheet Steel  
 with rubber mount

Length [mm] 280  
 Required quantity 2  
 replacement in pairs recommended



**References**

Ford 1 061 668

Ford 1 105 524

Ford 1 231 455

Ford 1 388 327

Ford 3M51-5K743-AB

Ford 3M51-5K743-AD

Ford 8V41-5K743-AA

Ford YS41-5K743-AB

Mazda BP4K-28-500B

Mazda BP4K-28-500D

Mazda C236-28-500

Volvo 30666300

Volvo 8646064

Ford 1 100 983

Ford 1 223 958

Ford 1 253 735

Ford 1 500 111

Ford 3M51-5K743-AC

Ford 3N61-5K743-BB

Ford 98AG-5K743-AF

Mazda BBP3-28-500A

Mazda BP4K-28-500C

Mazda BP4K-28-500E

Mazda C236-28-500A

Volvo 30683067

**Application info**

Ford C-Max I (02/07-09/10)

Ford Focus II (10/03--)

Ford Kuga II (05/12--)

Mazda 3 (BL) (12/08-12/14)

Mazda 5 (CW) (06/10--)

Volvo C70 II (03/06-12/13)

Ford Focus I (08/98-11/09)

Ford Kuga I (02/08-11/12)

Mazda 3 (BK) (09/99-12/09)

Mazda 5 (CR) (02/05-12/10)

Volvo C30 (09/06-12/13)

Volvo S40 II / V50 (12/03-12/12)

**Rod/strut, suspension****716 035 0005/S****MSR0106****Notes**

Front  
 Guide Rod  
 Rear Axle Left  
 Rear Axle Right  
 Sheet Steel  
 with accessories  
 with rubber mount

Length [mm]

280

Required quantity

2

replacement in pairs recommended



**References**

Ford 1 061 668	Ford 1 223 958
Ford 1 231 455	Ford 1 253 735
Ford 1 388 327	Ford 1 500 111
Ford 1 703 145	Ford 3M51-5K743-AB
Ford 3M51-5K743-AC	Ford 3M51-5K743-AD
Ford 3N61-5K743-BB	Ford 8V41-5K743-AA
Ford 98AG-5K743-AF	Ford BV61-5K743-AA
Mazda BBP3-28-500A	Mazda BP4K-28-500B
Mazda BP4K-28-500C	Mazda BP4K-28-500D
Mazda BP4K-28-500E	Mazda C236-28-500
Mazda C236-28-500A	Volvo 30666300
Volvo 30683067	Volvo 8646064

**Application info**

Ford C-Max I (02/07-09/10)	Ford Focus I (08/98-11/09)
Ford Focus II (10/03--)	Ford Focus III (07/10--)
Ford Kuga I (02/08-11/12)	Ford Kuga II (05/12--)
Mazda 3 (BK) (09/99-12/09)	Mazda 3 (BL) (12/08-12/14)
Mazda 5 (CR) (02/05-12/10)	Mazda 5 (CW) (06/10--)
Volvo C30 (09/06-12/13)	Volvo C70 II (03/06-12/13)
Volvo S40 II / V50 (12/03-12/12)	

**Stabilizer link****37-16 060 0056****MSL0865****Notes**

Coupling Rod  
Rear Axle Left  
Rear Axle Right

Length [mm]	130
Required quantity	2
Thread Size 1	M10x1,5
Thread Size 2	M10x1,5
replacement in pairs recommended	

**References**

Citroën 5170.F5	Citroën 5170.F6
Hyundai 55530-29000	Hyundai 55530-29300
Hyundai 55530-29500	Hyundai 56530-29000
Peugeot 16 08 078 280	Peugeot 5170.F5
Peugeot 5170.F6	

**Application info**

Citroën Jumper III (04/06--)  
 Hyundai Coupé II (05/96-04/02)  
 Hyundai Elantra I (03/00-09/06)  
 Peugeot Boxer III (09/05--)

Fiat Ducato (250) (07/06--)  
 Hyundai Coupé III (01/01-12/12)  
 Hyundai Lantra II (06/95-12/00)

**Stabilizer link****37-16 060 0057****MSL0866****Notes**

Coupling Rod  
 Front Axle Left  
 Front Axle Right  
 with spanner attachment

Length [mm] 237  
 Required quantity 2  
 Thread Size 1 M12X1,5  
 Thread Size 2 M12X1,5  
 replacement in pairs recommended

**References**

Hyundai 54830-2E000  
 Kia 54830 1F000

Hyundai 54830-2E100

**Application info**

Hyundai Tucson I (06/04--)

Kia Sportage II (09/04--)

**Stabilizer link****37-16 060 0058/HD****MSL1061HD****Notes**

Carbon Neutral  
 Coupling Rod  
 Front Axle Left  
 Front Axle Right

Length [mm] 288  
 Required quantity 2  
 Thread Size 1 M12 X 1,25  
 Thread Size 2 M12 X 1,25  
 reinforced version  
 replacement in pairs recommended

**References**

Hyundai 54830-3Z000

Hyundai 54830-3Z001

**Application info**

Hyundai i40 (07/11--)

**Stabilizer link****37-16 060 0059/HD****MSL1009HD****Notes**

Carbon Neutral  
Coupling Rod  
Front Axle Left  
Front Axle Right

Length [mm]

295

Required quantity

2

Thread Size 1

M12X1,5

Thread Size 2

M12X1,5

reinforced version

replacement in pairs recommended

**References**

Hyundai 54830-F2000

Kia 54830 F2000

Hyundai 54830-J9000

Kia 54830 J9000

**Application info**

Hyundai Elantra VI (09/15--)

Hyundai Kona I (06/17--)

Kia Ceed IV (03/18--)

Kia Niro I (DE) (09/16--)

Hyundai Ioniq (AE) (03/16--)

Hyundai i30 III (11/16--)

Kia Cerato IV (BD, BDM) (02/18--)

Kia Soul III (SK3) (01/19--)

**Stabilizer link****37-16 060 0060/HD****MSL1091HD****Notes**

Carbon Neutral  
Coupling Rod  
Rear Axle Left  
Rear Axle Right

Length [mm]

110

Required quantity

2

Thread Size 1

12x1,25

Thread Size 2

12x1,25

reinforced version

replacement in pairs recommended

**References**

Hyundai 55530-D3000

Kia 55530 D3000

Hyundai 55540-D3000

Kia 55540-D3000

**Application info**

Hyundai NEXO (03/18--)

Kia Sportage IV (09/15--)

Hyundai Tucson II (05/15--)

**Stabilizer link****37-16 060 0061/HD****MSL1092HD****Notes**

Carbon Neutral  
Coupling Rod  
Rear Axle Left  
Rear Axle Right

Length [mm]

95

Required quantity

2

Thread Size 1

12x1,25

Thread Size 2

12x1,25

reinforced version

replacement in pairs recommended

**References**

Hyundai 55530-3Z000

Hyundai 55540-3Z000

**Application info**

Hyundai i40 (07/11--)

**Stabilizer link****37-16 060 0063/HD****MSL1141HD****Notes**

Carbon Neutral  
Coupling Rod  
Rear Axle Left

Length [mm]

109

Paired article number

37-16 060 0064/HD | MSL1142HD

Required quantity

1

Thread Size 1

M12x1,5

reinforced version



replacement in pairs recommended

**References**

Hyundai 55530-J9500

**Application info**

Hyundai Kona I (06/17--)

Stabilizer link		37-16 060 0064/HD	MSL1142HD
<b>Notes</b>			
	Carbon Neutral		
	Coupling Rod		
	Rear Axle Right		
Length [mm]	109		
Paired article number	37-16 060 0063/HD   MSL1141HD		
Required quantity	1		
Thread Size 1	M12x1,5		
reinforced version			
replacement in pairs recommended			
<b>References</b>			
Hyundai 55540-J9500			
<b>Application info</b>			
Hyundai Kona I (06/17--)			
Stabilizer link		37-16 060 0065/HD	MSL1117HD
<b>Notes</b>			
	Carbon Neutral		
	Coupling Rod		
	Rear Axle Left		
Length [mm]	88		
Paired article number	37-16 060 0066/HD   MSL1118HD		
Required quantity	1		
Thread Size 1	12x1,5		
Thread Size 2	12x1,5		
reinforced version			
replacement in pairs recommended			
<b>References</b>			
Hyundai 55530-2W110		Kia 55530 2W110	
<b>Application info</b>			
Hyundai Santa Fé III (09/12--)		Kia Sorento II (06/09--)	

**Stabilizer link**

37-16 060 0066/HD

MSL1118HD

**Notes**Carbon Neutral  
Coupling Rod  
Rear Axle RightLength [mm] 88  
Paired article number 37-16 060 0065/HD | MSL1117HD  
Required quantity 1  
Thread Size 1 12x1,5  
Thread Size 2 12x1,5  
reinforced version  
replacement in pairs recommended**References**

Hyundai 55540-2W110

Kia 55540 2W110

**Application info**

Hyundai Santa Fé III (09/12--)

Kia Sorento II (06/09--)

Kia Sorento III (01/15--)

**Stabilizer link**

37-16 060 0067/HD

MSL1075HD

**Notes**Carbon Neutral  
Coupling Rod  
Front Axle LeftLength [mm] 110  
Paired article number 37-16 060 0068/HD | MSL1076HD  
Required quantity 1  
Thread Size 1 M10 X 1,5  
Thread Size 2 M10 X 1,5  
reinforced version  
replacement in pairs recommended**References**

ABARTH 6000612413

Fiat 6000612413

Mazda N243-34-170



**Application info**



ABARTH 124 Spider (348\_) (03/16--)

Fiat 124 Spider (348) (03/16--)

Mazda MX-5 (ND) (04/15--)



Stabilizer link		37-16 060 0068/HD	MSL1076HD
<b>Notes</b>  Carbon Neutral Coupling Rod Front Axle Right  Length [mm] 110 Paired article number 37-16 060 0067/HD   MSL1075HD Required quantity 1 Thread Size 1 M10 X 1,5 Thread Size 2 M10 X 1,5 reinforced version replacement in pairs recommended			
<b>References</b> ABARTH 6000612412 Fiat 6000612412 Mazda N243-34-150			
<b>Application info</b> ABARTH 124 Spider (348_) (03/16--) Fiat 124 Spider (348) (03/16--) Mazda MX-5 (ND) (04/15--)			
Stabilizer link		37-16 060 0069/HD	MSL1064HD
<b>Notes</b>  Carbon Neutral Coupling Rod Rear Axle Left  Length [mm] 60 Paired article number 37-16 060 0070/HD   MSL1065HD Required quantity 1 Thread Size 1 M10 X 1,5 Thread Size 2 M10 X 1,5 reinforced version replacement in pairs recommended			
<b>References</b> ABARTH 6000612344 Fiat 6000612344 Mazda N243-28-190			
<b>Application info</b> ABARTH 124 Spider (348_) (03/16--) Fiat 124 Spider (348) (03/16--) Mazda MX-5 (ND) (04/15--)			

Stabilizer link		37-16 060 0070/HD	MSL1065HD
<b>Notes</b>			
	Carbon Neutral		
	Coupling Rod		
	Rear Axle Right		
Length [mm]	60		
Paired article number	37-16 060 0069/HD   MSL1064HD		
Required quantity	1		
Thread Size 1	M10 X 1,5		
Thread Size 2	M10 X 1,5		
reinforced version			
replacement in pairs recommended			
<b>References</b>			
ABARTH 6000612343		Fiat 6000612343	
Mazda N243-28-170			
<b>Application info</b>			
ABARTH 124 Spider (348_) (03/16--)		Fiat 124 Spider (348) (03/16--)	
Mazda MX-5 (ND) (04/15--)			
Stabilizer link		37-16 060 0071/HD	MSL1127HD
<b>Notes</b>			
	Carbon Neutral		
	Coupling Rod		
	Front Axle Left		
	Front Axle Right		
Length [mm]	328		
Required quantity	2		
Thread Size 1	12x1,5		
Thread Size 2	12x1,5		
replacement in pairs recommended			
<b>References</b>			
Hyundai 54830-2W000		Kia 54830 2W000	
<b>Application info</b>			
Hyundai Santa Fé III (09/12--)		Kia Sorento II (06/09--)	

**Stabilizer link****37-16 060 0072/HD****MSL1163HD****Notes**Carbon Neutral  
Coupling Rod  
Front Axle RightLength [mm] 229  
Paired article number 37-16 060 0073/HD | MSL1164HD  
Required quantity 1  
Thread Size 1 10x1,5  
Thread Size 2 10x1,5  
reinforced version  
replacement in pairs recommended**References**

Hyundai 54831-K7100

**Application info**



Hyundai i10 III (09/19--)



**Stabilizer link****37-16 060 0073/HD****MSL1164HD****Notes**Carbon Neutral  
Coupling Rod  
Front Axle LeftLength [mm] 229  
Paired article number 28-16 060 0051  
Paired article number 37-16 060 0072/HD | MSL1163HD  
Required quantity 1  
Thread Size 1 10x1,5  
Thread Size 2 10x1,5  
reinforced version  
replacement in pairs recommended**References**

Hyundai 54830-K7100

**Application info**

Hyundai i10 III (09/19--)

Stabilizer link		37-16 060 0076	MSL1200
<b>Notes</b>  Coupling Rod Rear Axle Right Length [mm] 110 Paired article number 37-16 060 0077   MSL1201 Required quantity 1 Thread Size 1 M12 x 1,25 Thread Size 2 M12 X 1,25 replacement in pairs recommended			
<b>References</b> GENESIS 55531-GI000 Hyundai 55531-GI000 Kia 55531 GI000			
<b>Application info</b> GENESIS GV60 (JW) (10/21--) Hyundai Ioniq 6 (CE) (10/22--) Hyundai Ioniq 5 (NE) (05/21--) Kia EV6 (10/21--)			
Stabilizer link		37-16 060 0077	MSL1201
<b>Notes</b>  Coupling Rod Rear Axle Left Length [mm] 110 Paired article number 37-16 060 0076   MSL1200 Required quantity 1 Thread Size 1 M12 x 1,25 Thread Size 2 M12 x 1,25 replacement in pairs recommended			
<b>References</b> GENESIS 55530-GI000 Hyundai 55530-GI000 Kia 55530 GI000			
<b>Application info</b> GENESIS GV60 (JW) (10/21--) Hyundai Ioniq 6 (CE) (10/22--) Hyundai Ioniq 5 (NE) (05/21--) Kia EV6 (10/21--)			

Stabilizer link		38-16 060 0000	MSL0468
<p><b>Notes</b></p> <p>Coupling Rod Front Axle Left Front Axle Right</p> <p>Length [mm] 185 Required quantity 2 Thread Size 1 M10x1,25 Thread Size 2 M10x1,25 replacement in pairs recommended</p>			
<p><b>References</b></p> <p>Daewoo 44750-05000 Daewoo 44750-05001 Daewoo 44750-05002 Ssangyong 44750-05000 Ssangyong 44750-05001 Ssangyong 44750-05002</p>			
<p><b>Application info</b></p> <p>Daewoo Korando (11/98--) Ssangyong Korando II (KJ) (12/96-11/06)</p> <p>Daewoo Musso (07/98--) Ssangyong Musso (FJ) (01/93--)</p>			
Stabilizer link		39-16 060 0000	MSL0469
<p><b>Notes</b></p> <p>Coupling Rod Front Axle Right</p> <p>Length [mm] 50 Paired article number 39-16 060 0002   MSL0470 Required quantity 1 Thread Size 1 M10x1,25 Thread Size 2 M10x1,25 replacement in pairs recommended</p>			
<p><b>References</b></p> <p>Daihatsu 48821-B1010 Daihatsu 48821-B1010000 Daihatsu 48821-B1030 Daihatsu 48821-B1031 Subaru 48821-B1010 Subaru 48821-B1010000 Subaru 48821-B1030 Subaru 48821-B1031</p>			
<p><b>Application info</b></p> <p>Daihatsu Sirion II (01/05--) Subaru Justy IV (01/07--)</p>			

**Stabilizer link** **39-16 060 0002** **MSL0470**

<b>Notes</b>	Coupling Rod Front Axle Left  Length [mm] 50 Paired article number 39-16 060 0000   MSL0469 Required quantity 1 Thread Size 1 M10x1,25 Thread Size 2 M10x1,25 replacement in pairs recommended	
--------------	--	---

<b>References</b>	
Daihatsu 48831-B1010	Daihatsu 48831-B1010000
Daihatsu 48831-B1020	Daihatsu 48831-B1021
Daihatsu 48831-V1010	Subaru 48831-B1010
Subaru 48831-B1010000	Subaru 48831-B1020
Subaru 48831-B1021	Subaru 48831-V1010

<b>Application info</b>	
Daihatsu Sirion II (01/05--)	Subaru Justy IV (01/07--)

**Stabilizer link** **416 060 0008** **MSL0476**

<b>Notes</b>	Coupling Rod  Length [mm] 200 Paired article number 416 060 0009   MSL0477 Required quantity 1 Thread Size 1 M12x1,5 Thread Size 2 M10x1,5 replacement in pairs recommended	
--------------	--	---

<b>References</b>	
Porsche 996 343 069 02	Porsche 996 343 069 03
Porsche 996 343 069 04	

<b>Application info</b>	
Porsche 911 (996) (09/97-09/05)	Porsche Boxster (986) (09/96-12/04)

**Stabilizer link****416 060 0009****MSL0477****Notes**

Coupling Rod

Length [mm]

200

Paired article number

416 060 0008 | MSL0476

Required quantity

1

Thread Size 1

M12x1,5

Thread Size 2

M10x1,5

replacement in pairs recommended

**References**

Porsche 996 343 070 02

Porsche 996 343 070 03

Porsche 996 343 070 04

**Application info**

Porsche 911 (996) (09/97-09/05)

Porsche Boxster (986) (09/96-12/04)

**Stabilizer link****416 060 0012/HD****MSL0598HD****Notes**

Carbon Neutral

Coupling Rod

with spanner attachment

Length [mm]

200

Paired article number

416 060 0013/HD | MSL0600HD

Required quantity

1

Thread Size 1

M12x1,5

Thread Size 2

M10x1,5

reinforced version

replacement in pairs recommended

**References**

Porsche 997 343 069 00

Porsche 997 343 069 01

Porsche 997 343 069 02

Porsche 997 343 069 03

Porsche 997 343 069 04

**Application info**

Porsche 911 (997) (07/04-12/13)

Porsche Boxster (981) (04/12--)



Porsche Boxster (982) (04/16--)

Porsche Boxster (987) (06/04-12/13)



Porsche Cayman (981) (03/13--)

Porsche Cayman (982) (04/16--)

Porsche Cayman (987) (11/05-12/13)

Stabilizer link		416 060 0013/HD	MSL0600HD
<b>Notes</b>  Carbon Neutral Coupling Rod with spanner attachment  Length [mm] 200 Paired article number 416 060 0012/HD   MSL0598HD Required quantity 1 Thread Size 1 M12x1,5 Thread Size 2 M10x1,5 reinforced version replacement in pairs recommended			
<b>References</b> Porsche 997 343 070 00 Porsche 997 343 070 01 Porsche 997 343 070 02 Porsche 997 343 070 03 Porsche 997 343 070 04			
<b>Application info</b> Porsche 911 (997) (07/04-12/13) Porsche Boxster (981) (04/12--) Porsche Boxster (982) (04/16--) Porsche Cayman (981) (03/13--) Porsche Cayman (987) (11/05-12/13) Porsche Boxster (987) (06/04-12/13) Porsche Cayman (982) (04/16--) 			
Stabilizer link		416 060 0015	MSL0612
<b>Notes</b>  Coupling Rod Rear Axle Left  Length [mm] 85 Paired article number 416 060 0016   MSL0613 Required quantity 1 Thread Size 1 M10x1,5 Thread Size 2 M10x1,5 replacement in pairs recommended			
<b>References</b> Porsche 997 333 069 04 Porsche 997 333 069 05 Porsche 997 333 069 06			
<b>Application info</b> Porsche 911 (997) (07/04-12/13)			



Stabilizer link		416 060 0016	MSL0613
<p><b>Notes</b></p> <p>Coupling Rod Rear Axle Right</p> <p>Length [mm] 85</p> <p>Paired article number 416 060 0015   MSL0612</p> <p>Required quantity 1</p> <p>Thread Size 1 M10x1,5</p> <p>Thread Size 2 M10x1,5</p> <p>replacement in pairs recommended</p>			
<p><b>References</b></p> <p>Porsche 997 333 070 04 Porsche 997 333 070 05</p> <p>Porsche 997 333 070 06</p>			
<p><b>Application info</b></p> <p>Porsche 911 (997) (07/04-12/13)</p>			
Stabilizer link		416 060 0017/HD	MSL0614HD
<p><b>Notes</b></p> <p>Carbon Neutral Coupling Rod Rear Axle Left Rear Axle Right with spanner attachment</p> <p>Length [mm] 99.5</p> <p>Required quantity 2</p> <p>Thread Size 1 M10x1,5</p> <p>Thread Size 2 M10x1,5</p> <p>reinforced version</p> <p>replacement in pairs recommended</p>			
<p><b>References</b></p> <p>Porsche 996 333 069 02 Porsche 996 333 069 03</p> <p>Porsche 996 333 069 04</p>			
<p><b>Application info</b></p> <p>Porsche 911 (996) (09/97-09/05)</p>			

**Stabilizer link**

416 060 0020

MSL0654

**Notes**

Coupling Rod  
 Front Axle Left  
 Front Axle Right

Length [mm]

284.7

Required quantity

2

Thread Size 1

M10x1,5

Thread Size 2

M10x1,5

replacement in pairs recommended

**References**

Porsche 996 343 073 03

Porsche 996 343 073 04

Porsche 996 343 073 05

**Application info**

Porsche 911 (996) (09/97-09/05)

**Stabilizer link**

416 060 0023

MSL0946

**Notes**

Coupling Rod  
 Rear Axle Left  
 Rear Axle Right

Inner Diameter 1 [mm]

10.1

Inner Diameter 2 [mm]

10.1

Length [mm]

60

Required quantity

2



replacement in pairs recommended



**References**

Porsche 95B 505 465

**Application info**

Porsche Macan (95B) (02/14--)

Stabilizer link		416 060 0024/HD	MSL1078HD
<b>Notes</b>			
	Carbon Neutral		
	Coupling Rod		
	Front Axle Right		
Length [mm]	259		
Paired article number	416 060 0025/HD   MSL1079HD		
Required quantity	1		
Thread Size 1	M12x1,5		
Thread Size 2	M10x1,5		
reinforced version			
replacement in pairs recommended			
<b>References</b>			
Porsche 991 343 070 02		Porsche 9P1 411 318	
<b>Application info</b>			
Porsche 911 (991) (12/11--)		Porsche 911 (992) (11/18--)	
Porsche Boxster (981) (04/12--)		Porsche Boxster (982) (04/16--)	
Porsche Cayman (981) (03/13--)		Porsche Cayman (982) (04/16--)	
Stabilizer link		416 060 0025/HD	MSL1079HD
<b>Notes</b>			
	Carbon Neutral		
	Coupling Rod		
	Front Axle Left		
Length [mm]	259		
Paired article number	416 060 0024/HD   MSL1078HD		
Required quantity	1		
Thread Size 1	M12x1,5		
Thread Size 2	M10x1,5		
reinforced version			
replacement in pairs recommended			
<b>References</b>			
Porsche 991 343 069 02		Porsche 9P1 411 317	
<b>Application info</b>			
Porsche 911 (991) (12/11--)		Porsche 911 (992) (11/18--)	
Porsche Boxster (981) (04/12--)		Porsche Boxster (982) (04/16--)	
Porsche Cayman (981) (03/13--)		Porsche Cayman (982) (04/16--)	

Stabilizer link		416 060 0026/HD	MSL1084HD
<p><b>Notes</b></p> <p>Carbon Neutral Coupling Rod Rear Axle Left Rear Axle Right</p> <p>Length [mm] 235 Required quantity 2 Thread Size 1 M12x1,5 Thread Size 2 M10x1,5 reinforced version replacement in pairs recommended</p>			
<p><b>References</b></p> <p>Porsche 991 333 071 02 Porsche 9P1 511 467 A</p>			
<p><b>Application info</b></p> <p>Porsche 911 (991) (12/11--) Porsche 911 (992) (11/18--)</p>			
Stabilizer link		416 060 0027/HD	MSL1153HD
<p><b>Notes</b></p> <p>Carbon Neutral Coupling Rod Rear Axle Left Rear Axle Right</p> <p>Length [mm] 144 Required quantity 2 Thread Size 1 M12x1,5 reinforced version replacement in pairs recommended</p>			
<p><b>References</b></p> <p>Porsche 971 511 467 C</p>			
<p><b>Application info</b></p> <p>Porsche Panamera (971) (05/16--)</p>			

**Stabilizer link**

416 060 0028/HD

MSL1152HD

**Notes**

Carbon Neutral  
Coupling Rod  
Rear Axle Left  
Rear Axle Right

Length [mm]

143.5

Required quantity

2

Thread Size 1

M10x1,5

reinforced version

replacement in pairs recommended

**References**

Audi 971 511 467 D

Audi 971 511 467 F

Porsche 971 511 467 B

Porsche 971 511 467 D

Porsche 971 511 467 F

**Application info**

Audi E-TRON (GE\_) (09/18--)

Porsche Panamera (971) (05/16--)

Porsche Taycan (Y1\_) (05/19--)

**Stabilizer link**

416 060 0031/HD

MSL1098HD

**Notes**

Carbon Neutral  
Coupling Rod  
Front Axle Left  
Front Axle Right

Length [mm]

159.2

Required quantity

2

Thread Size 1

M12x1,5

replacement in pairs recommended

**References**

Porsche 970 343 069 01

Porsche 970 343 069 02

Porsche 970 343 069 03

**Application info**

Porsche Panamera (970) (03/09-12/17)

**Stabilizer link**

416 060 0032/HD

MSL1103HD

**Notes**

Carbon Neutral  
Coupling Rod  
Rear Axle Left  
Rear Axle Right

Inner Diameter 1 [mm]

12.1

Length [mm]

150

Required quantity

2

Thread Size 1

M10x1,5

reinforced version

replacement in pairs recommended

**References**

Porsche 970 333 069 03

Porsche 970 333 069 04

Porsche 970 333 069 05

**Application info**

Porsche Panamera (970) (03/09-12/17)

**Stabilizer link**

416 060 0034/HD

MSL1093HD

**Notes**

Carbon Neutral  
Coupling Rod  
Front Axle Left  
Front Axle Right

Length [mm]

157

Required quantity

2

Thread Size 1

M12x1,5

Thread Size 2

M12x1,5

reinforced version

replacement in pairs recommended

**References**

Porsche 970 343 069 21

Porsche 970 343 069 22

Porsche 970 343 069 23

**Application info**

Porsche Panamera (970) (03/09-12/17)

**Stabilizer link**

44-16 060 0000/HD

MSL0481HD

**Notes**

Carbon Neutral  
Coupling Rod  
Front Axle Left  
Front Axle Right  
with spanner attachment

Length [mm]

310

Required quantity

2

Thread Size 1

M12x1,5

Thread Size 2

M12x1,5

reinforced version

replacement in pairs recommended

**References**

Chrysler 4694855

Chrysler 4743454AA

Chrysler 4743454AC

Chrysler 4743669AB

Volkswagen 7B0 411 315

Chrysler 4743021AA

Chrysler 4743454AB

Chrysler 4743669AA

Chrysler 4743669AC

**Application info**

Chrysler Voyager III/Caravan (01/95-12/01)

Chrysler Voyager V/Town Country (10/07--)

Dodge Caravan III (02/00-12/07)

Volkswagen Routan (09/08-12/13)

Chrysler Voyager IV/ Town Country (09/99-12/08)

Dodge Caravan II (01/95-03/01)

Lancia Voyager (09/11-12/14)

**Stabilizer link**

44-16 060 0003

MSL0483

**Notes**

Coupling Rod  
Rear Axle Left  
Rear Axle Right

Length [mm]

185

Required quantity

2

replacement in pairs recommended

**References**

Chrysler 04656934AB

Chrysler 4656934AB

**Application info**

Chrysler PT Cruiser (06/00-12/10)

**Stabilizer link**

44-16 060 0004

MSL0484

**Notes**

Coupling Rod

Front Axle Left

Length [mm]

214

Paired article number

44-16 060 0005 | MSL0485

Required quantity

1

Thread Size 1

M14x2

Thread Size 2

M14x2

replacement in pairs recommended

**References**

Chrysler 04895483AA

Chrysler 04895483AB

Chrysler 04895483AC

Chrysler K04895483AC

Lancia K04782717AA

Lancia K04895483AA

Lancia K04895483AB

Lancia K04895483AC

**Application info**

Chrysler 300 C (09/04--)

Lancia Thema II (09/11-10/14)

**Stabilizer link**

44-16 060 0005

MSL0485

**Notes**

Coupling Rod

Front Axle Right

Length [mm]

214

Paired article number

44-16 060 0004 | MSL0484

Required quantity

1

Thread Size 1

M14x2

Thread Size 2

M14x2

replacement in pairs recommended

**References**

Chrysler 04895482AA

Chrysler 04895482AB

Chrysler 04895482AC

Chrysler K04895482AC

Lancia K04782716AA

Lancia K04895482AA

Lancia K04895482AB



Lancia K04895482AC

**Application info**

Chrysler 300 C (09/04--)

Lancia Thema II (09/11-10/14)



Stabilizer link		44-16 060 0006/HD	MSL0615HD
<b>Notes</b>  Carbon Neutral Coupling Rod Rear Axle Left Rear Axle Right  Length [mm] 80 Required quantity 2 Thread Size 1 M10x1,5 Thread Size 2 M10X1,5 reinforced version replacement in pairs recommended			
<b>References</b> Chrysler 05174245AA Chrysler 05174245AC Dodge 05174245AA Lancia K05174245AC		Chrysler 05174245AB Chrysler K05174245AB Jeep 05174245AD Lancia K05174245AD	
<b>Application info</b> Chrysler Sebring (JS) (09/06-12/10) Dodge Caliber (06/06--) Jeep Patriot (MK) (02/07-12/17)		Dodge Avenger II (06/07-12/14) Jeep Compass (MK) (08/06--) Lancia Flavia (03/12-12/14)	
Stabilizer link		45-16 060 0000/HD	MSL0590HD
<b>Notes</b>  Carbon Neutral Coupling Rod Front Axle Left Front Axle Right with spanner attachment  Length [mm] 307.5 Required quantity 2 Thread Size 1 10x1,5 Thread Size 2 10x1,5 reinforced version replacement in pairs recommended			
<b>References</b> MG RBM 100240 Rover RBM100240		MG RBM100240SLP	

**Application info**

Rover 75 (RJ) (02/99-06/06)

**Stabilizer link**

516 060 0000/HD

MSL0489HD

**Notes**

Carbon Neutral  
Coupling Rod  
with spanner attachment

Length [mm] 302  
Required quantity 2  
Thread Size 1 M10x1,5  
Thread Size 2 M10x1,5  
reinforced version  
replacement in pairs recommended  
short version

**References**

Volvo 1387860  
Volvo 30714686  
Volvo 8628703  
Volvo 9492804

Volvo 30647995  
Volvo 31212730  
Volvo 9140767

**Application info**

Volvo 850 (06/91-10/97)  
Volvo XC70 I (10/97-10/07)

Volvo C/S/V 70 (12/95-10/05)

**Stabilizer link**

516 060 0009

MSL0493

**Notes**

Coupling Rod  
Front Axle Left  
Front Axle Right

Length [mm] 267  
Required quantity 2  
Thread Size 1 M10x1,25  
Thread Size 2 M10x1,25  
replacement in pairs recommended

**References**

Volvo 30884179

**Application info**

Volvo S/V 40 (07/95-12/04)

**Stabilizer link**

516 060 0012/HD

MSL0494HD

**Notes**

Carbon Neutral  
Coupling Rod  
Rear Axle Left  
Rear Axle Right  
with spanner attachment

Length [mm]

140

Required quantity

2

Thread Size 1

M12x1,5

Thread Size 2

M12x1,5

reinforced version

replacement in pairs recommended

short version

**References**

Volvo 3064792

Volvo 30647920

Volvo 30714678

Volvo 31201603

Volvo 8634869

Volvo 8672446

Volvo 9169080

Volvo 91690800

**Application info**

Volvo C/S/V 70 (12/95-10/05)

Volvo S60 I / V70 II (11/99-04/10)

Volvo S80 I (05/98-02/08)

Volvo XC70 I (10/97-10/07)

Volvo XC90 I (06/02-01/15)

**Stabilizer link**

516 060 0014/HD

MSL0495HD

**Notes**

Carbon Neutral  
Coupling Rod  
Front Axle Left  
Front Axle Right  
with spanner attachment

Length [mm]

200

Required quantity

2

Thread Size 1

M10x1,5

Thread Size 2

M10x1,5

reinforced version

replacement in pairs recommended



**References**

Mitsubishi MR131680  
 Volvo 30871770  
 Volvo 30884358

Mitsubishi MR272116  
 Volvo 30873100

**Application info**

Mitsubishi Carisma (07/95-06/06)

Volvo S/V 40 (07/95-12/04)

**Stabilizer link****516 060 0015/HD****MSL0496HD****Notes**

Carbon Neutral  
 Coupling Rod  
 Front Axle Left  
 Front Axle Right  
 with spanner attachment

Length [mm]

332

Required quantity

2

Thread Size 1

M10x1,5

Thread Size 2

M12x1,5

long version

reinforced version

replacement in pairs recommended

**References**

Volvo 274303  
 Volvo 30714685  
 Volvo 31212692  
 Volvo 8634736  
 Volvo 9200603

Volvo 274456  
 Volvo 31201602  
 Volvo 31216292  
 Volvo 8672445  
 Volvo 92006030

**Application info**

Volvo S60 I / V70 II (11/99-04/10)  
 Volvo XC70 I (10/97-10/07)

Volvo S80 I (05/98-02/08)  
 Volvo XC90 I (06/02-01/15)



**Application info**

Volvo C/S/V 70 (12/95-10/05)

Volvo S80 I (05/98-02/08)

Volvo XC90 I (06/02-01/15)

Volvo S60 I / V70 II (11/99-04/10)

Volvo XC70 I (10/97-10/07)

**Stabilizer link****516 060 0020****MSL0871****Notes**

Coupling Rod  
 Front Axle Left  
 Front Axle Right  
 with spanner attachment

Length [mm]

332

Required quantity

2

Thread Size 1

M10x1,5

Thread Size 2

M12x1,5

long version

replacement in pairs recommended

**References**

Volvo 274303

Volvo 30714685

Volvo 31212692

Volvo 8634736

Volvo 9200603

Volvo 274456

Volvo 31201602

Volvo 31216292

Volvo 8672445

Volvo 92006030

**Application info**

Volvo S60 I / V70 II (11/99-04/10)

Volvo XC70 I (10/97-10/07)

Volvo S80 I (05/98-02/08)

Volvo XC90 I (06/02-01/15)

**Stabilizer link****516 060 0021****MSL0872****Notes**

Coupling Rod  
 Front Axle Left  
 Front Axle Right  
 with spanner attachment

Length [mm]

243

Required quantity

2

Thread Size 1

M10x1,5

Thread Size 2

M10x1,5

replacement in pairs recommended



**References**

Volvo 272991  
Volvo 9492837

Volvo 6819253

**Application info**

Volvo 940 / 960 / S/V 90 (09/90-12/98)

**Stabilizer link**

516 060 0022/HD

MSL1101HD

**Notes**

Carbon Neutral  
Coupling Rod  
Rear Axle Right

Length [mm] 100  
Paired article number 516 060 0023/HD | MSL1102HD  
Required quantity 1  
Thread Size 1 M12x1,5  
Thread Size 2 M12x1,5  
reinforced version  
replacement in pairs recommended



**References**

Volvo 31387675

**Application info**

Volvo S60 III (224) (02/19--)  
Volvo V60 II (02/18--)  
Volvo XC90 II (09/14--)

Volvo S90 II / V90 II (03/16--)  
Volvo XC60 II (03/17--)

**Stabilizer link**

516 060 0023/HD

MSL1102HD

**Notes**

Carbon Neutral  
Coupling Rod  
Rear Axle Left

Length [mm] 100  
Paired article number 516 060 0022/HD | MSL1101HD  
Paired article number 516 060 0024/HD | MSL1016HD  
Required quantity 1  
Thread Size 1 M12x1,5  
Thread Size 2 M12x1,5  
reinforced version  
replacement in pairs recommended



**References**

Volvo 31387674

**Application info**

Volvo S60 III (224) (02/19--)

Volvo V60 II (02/18--)

Volvo XC90 II (09/14--)

Volvo S90 II / V90 II (03/16--)

Volvo XC60 II (03/17--)

**Stabilizer link****516 060 0024/HD****MSL1016HD****Notes**Carbon Neutral  
Coupling Rod  
Front Axle Right

Length [mm]

180

Paired article number

516 060 0023/HD | MSL1102HD

Paired article number

516 060 0025/HD | MSL1017HD

Required quantity

1

Thread Size 1

M12x1,5

Thread Size 2

M12x1,5

reinforced version

replacement in pairs recommended

**References**

Volvo 31360658

Volvo 31406874

**Application info**

Volvo S90 II / V90 II (03/16--)

Volvo XC60 II (03/17--)

Volvo V60 II (02/18--)

Volvo XC90 II (09/14--)

**Stabilizer link****516 060 0025/HD****MSL1017HD****Notes**Carbon Neutral  
Coupling Rod  
Front Axle Left

Length [mm]

180

Paired article number

516 060 0024/HD | MSL1016HD

Required quantity

1

Thread Size 1

M12x1,5

Thread Size 2

M12x1,5

reinforced version

replacement in pairs recommended





**References**

Volvo 31406873

**Application info**

Volvo S90 II / V90 II (03/16--)

Volvo XC60 II (03/17--)

Volvo V60 II (02/18--)

Volvo XC90 II (09/14--)

**Stabilizer link**

516 060 0026/HD

MSL1012HD

**Notes**

Carbon Neutral  
Coupling Rod  
Front Axle Right

Length [mm]

168

Paired article number

516 060 0027/HD | MSL1013HD

Required quantity

1

Thread Size 1

M12x1,5

Thread Size 2

M12x1,5

reinforced version

replacement in pairs recommended



**References**

Volvo 31658287

**Application info**

Volvo S60 III (224) (02/19--)

Volvo V60 II (02/18--)

**Stabilizer link**

516 060 0027/HD

MSL1013HD

**Notes**

Carbon Neutral  
Coupling Rod  
Front Axle Left

Length [mm]

168

Paired article number

516 060 0026/HD | MSL1012HD

Required quantity

1

Thread Size 1

M12x1,5

Thread Size 2

M12x1,5

reinforced version

replacement in pairs recommended



**References**

Volvo 31476640

Volvo 31658286

**Application info**

Volvo S60 III (224) (02/19--)

Volvo V60 II (02/18--)

**Stabilizer link**

516 060 0028/HD

MSL1151HD

**Notes**

Carbon Neutral  
Coupling Rod  
Rear Axle Left  
Rear Axle Right  
Steel

Inner Diameter [mm]

10.3

Length [mm]

145

Pipe Diameter [mm]

10

Required quantity

2

Thread Size 1

M10x1,5

replacement in pairs recommended

**References**

POLESTAR 32221272

Volvo 32221272

**Application info**

POLESTAR POLESTAR 2 (02/19--)

Volvo C40 (539) (10/21--)

Volvo XC40 (536) (10/17--)

**Stabilizer link**

516 060 0029/HD

MSL0999HD

**Notes**

Carbon Neutral  
Coupling Rod  
Front Axle Left  
Front Axle Right

Length [mm]

276

Required quantity

2

Thread Size 1

M10x1,5

Thread Size 2

M10x1,5

reinforced version

replacement in pairs recommended

**References**

POLESTAR 32221271

POLESTAR 32344015

Volvo 31658405

Volvo 32221271

Volvo 32344015

**Application info**

POLESTAR POLESTAR 2 (02/19--)  
Volvo XC40 (536) (10/17--)

Volvo C40 (539) (10/21--)

**Stabilizer link****516 060 9600/HD****MSL0498HD****Notes**

Carbon Neutral  
Coupling Rod  
Front Axle Left  
Front Axle Right  
with spanner attachment

Length [mm]

243

Required quantity

2

Thread Size 1

M10x1,5

Thread Size 2

M10x1,5

reinforced version

replacement in pairs recommended

**References**

Volvo 272991

Volvo 6819253

Volvo 9492837

**Application info**

Volvo 940 / 960 / S/V 90 (09/90-12/98)

**Stabilizer link****53-16 060 0004/HD****MSL0499HD****Notes**

Carbon Neutral  
Coupling Rod  
Front Axle Left  
Front Axle Right  
with spanner attachment

Length [mm]

100

Required quantity

2

Thread Size 1

M12x1,5

Thread Size 2

M12x1,5

reinforced version

replacement in pairs recommended

**References**

Land Rover ANR3304

**Application info**

Land Rover Range Rover II (07/94-03/02)

**Stabilizer link**

53-16 060 0005/HD

MSL0500HD

**Notes**

Carbon Neutral  
Coupling Rod  
Front Axle Left  
Front Axle Right  
with spanner attachment

Length [mm]

246

Required quantity

2

Thread Size 1

M12x1,5

Thread Size 2

M12x1,25

reinforced version

replacement in pairs recommended

**References**

Land Rover RBM100223

**Application info**

Land Rover Discovery II (10/98-08/04)

**Stabilizer link**

53-16 060 0006/HD

MSL0501HD

**Notes**

Carbon Neutral  
Coupling Rod  
Rear Axle Left  
Rear Axle Right  
with spanner attachment

Length [mm]

159

Required quantity

2

Thread Size 1

M12x1,5

Thread Size 2

M12x1,25

reinforced version

replacement in pairs recommended

**References**

Land Rover RGD100682

**Application info**

Land Rover Discovery II (10/98-08/04)

**Stabilizer link**

53-16 060 0007/HD

MSL0502HD

**Notes**

Carbon Neutral  
Coupling Rod  
Front Axle Left  
Front Axle Right  
with spanner attachment

Length [mm]

380

Required quantity

2

Thread Size 1

M12x1,5

Thread Size 2

M12x1,5

reinforced version

replacement in pairs recommended

**References**

Land Rover LR030047

Land Rover RBM000011

Land Rover RBM500200

**Application info**

Land Rover Range Rover III (03/02-12/12)

**Stabilizer link**

53-16 060 0008/HD

MSL0503HD

**Notes**

Carbon Neutral  
Coupling Rod  
Front Axle Left  
Front Axle Right  
with spanner attachment

Length [mm]

310

Required quantity

2

Thread Size 1

M12x1,75

Thread Size 2

M12x1,75

reinforced version

replacement in pairs recommended

**References**

Land Rover LR014145

**Application info**

Land Rover Discovery IV (09/09-12/18)

**Stabilizer link**

53-16 060 0009/HD

MSL0504HD

**Notes**

Carbon Neutral  
Coupling Rod  
Front Axle Left  
Front Axle Right  
with spanner attachment

Length [mm] 300  
Required quantity 2  
Thread Size 1 M12x1,75  
Thread Size 2 M12x1,75  
reinforced version  
replacement in pairs recommended



**References**

Land Rover RBM500110  
Land Rover RBM500190

Land Rover RBM500180

**Application info**

Land Rover Discovery III (07/04-09/09)

**Stabilizer link**

53-16 060 0010/HD

MSL0505HD

**Notes**

Carbon Neutral  
Coupling Rod  
Rear Axle Left  
Rear Axle Right

Length [mm] 120  
Required quantity 2  
Thread Size 1 M12x1,75  
Thread Size 2 M12x1,75  
reinforced version  
replacement in pairs recommended



**References**

Land Rover RGD000311

Land Rover RGD000312

**Application info**

Land Rover Discovery III (07/04-09/09)

Land Rover Discovery IV (09/09-12/18)

Land Rover Range Rover Sport I (02/05-03/13)

**Stabilizer link**

53-16 060 0011

MSL0506

**Notes**Coupling Rod  
Front Axle Right

Length [mm] 345  
 Paired article number 53-16 060 0012 | MSL0507  
 Required quantity 1  
 Thread Size 1 M14x2,0  
 Thread Size 2 M14x2,0  
 replacement in pairs recommended

**References**

Land Rover RBM500140

**Application info**

Land Rover Discovery III (07/04-09/09)

Land Rover Discovery IV (09/09-12/18)

Land Rover Range Rover Sport I (02/05-03/13)

**Stabilizer link**

53-16 060 0012

MSL0507

**Notes**Coupling Rod  
Front Axle Left

Length [mm] 345  
 Paired article number 53-16 060 0011 | MSL0506  
 Required quantity 1  
 Thread Size 1 M14x2,0  
 Thread Size 2 M14x2,0  
 replacement in pairs recommended

**References**

Land Rover RBM500150

**Application info**

Land Rover Discovery III (07/04-09/09)

Land Rover Discovery IV (09/09-12/18)

Land Rover Range Rover Sport I (02/05-03/13)

**Stabilizer link** **53-16 060 0013** **MSL0508**

**Notes**

Coupling Rod  
 Front Axle Left  
 Front Axle Right  
 Rear Axle Left  
 Rear Axle Right

Length [mm] 65  
 Required quantity 2  
 Thread Size 1 M12x1,75  
 replacement in pairs recommended



**References**

Land Rover NTC1888

**Application info**

Land Rover Defender I (05/90-05/16)  
 Land Rover Range Rover I (10/69-04/96)

Land Rover Discovery I (06/89-12/98)

**Stabilizer link** **53-16 060 0014/HD** **MSL0509HD**

**Notes**

Carbon Neutral  
 Coupling Rod  
 Front Axle Left  
 Front Axle Right  
 with spanner attachment

Length [mm] 350  
 Required quantity 2  
 Thread Size 1 M10x1,5  
 Thread Size 2 M10x1,5  
 reinforced version  
 replacement in pairs recommended



**References**

Land Rover LR002626

**Application info**

Land Rover Freelander II (10/06-12/15)



**Stabilizer link**

53-16 060 0015/HD

MSL0510HD

**Notes**

Carbon Neutral  
Coupling Rod  
Rear Axle Left  
Rear Axle Right

Length [mm]

120

Required quantity

2

Thread Size 1

M12x1,5

Thread Size 2

M12x1,5

reinforced version

replacement in pairs recommended

**References**

Land Rover LR030048

Land Rover RGD000130

Land Rover RGD000131

Land Rover RGD500150

**Application info**

Land Rover Range Rover III (03/02-12/12)

**Stabilizer link**

53-16 060 0016/HD

MSL0511HD

**Notes**

Carbon Neutral  
Coupling Rod  
Front Axle Left  
Front Axle Right  
with spanner attachment

Length [mm]

203

Required quantity

2

Thread Size 1

M12x1,5

Thread Size 2

M10x1,5

reinforced version

replacement in pairs recommended

**References**

Land Rover RBM100170

Land Rover RBM100171

Land Rover RBM100172

**Application info**

Land Rover Freelander I (02/98-10/06)

<b>Stabilizer link</b>	<b>53-16 060 0017/HD</b>	<b>MSL0512HD</b>
------------------------	--------------------------	------------------

<p><b>Notes</b></p> <ul style="list-style-type: none"> <li>Carbon Neutral</li> <li>Coupling Rod</li> <li>Rear Axle Left</li> <li>Rear Axle Right</li> </ul> <p>Length [mm] 135</p> <p>Required quantity 2</p> <p>Thread Size 1 M12x1,75</p> <p>Thread Size 2 M12x1,75</p> <p>reinforced version</p> <p>replacement in pairs recommended</p>	
---	---

<b>References</b>	Land Rover RGD500140
-------------------	----------------------

<b>Application info</b>	Land Rover Range Rover Sport I (02/05-03/13)
-------------------------	--

<b>Stabilizer link</b>	<b>53-16 060 0019/HD</b>	<b>MSL0581HD</b>
------------------------	--------------------------	------------------

<p><b>Notes</b></p> <ul style="list-style-type: none"> <li>Carbon Neutral</li> <li>Coupling Rod</li> <li>Front Axle Left</li> <li>Front Axle Right</li> <li>with spanner attachment</li> </ul> <p>Length [mm] 320</p> <p>Required quantity 2</p> <p>Thread Size 1 M10x1,5</p> <p>Thread Size 2 M10x1,5</p> <p>reinforced version</p> <p>replacement in pairs recommended</p>	
--	---

<b>References</b>	Jaguar J9C1154 <span style="float: right;">Land Rover LR024474</span>
-------------------	---

<b>Application info</b>	Jaguar E-Pace (X540) (09/17--) Land Rover Range Rover Evoque I (06/11-12/19) <span style="float: right;">Land Rover Discovery Sport (09/14--)</span>
-------------------------	--

**Stabilizer link** 53-16 060 0020 MSL0873

**Notes**

Coupling Rod  
 Front Axle Left  
 Front Axle Right  
 with spanner attachment

Length [mm] 100  
 Required quantity 2  
 Thread Size 1 M12x1,5  
 Thread Size 2 M12x1,5  
 replacement in pairs recommended



**References**

Land Rover ANR3304

**Application info**

Land Rover Range Rover II (07/94-03/02)

**Stabilizer link** 53-16 060 0023 MSL0876

**Notes**

Coupling Rod  
 Front Axle Left  
 Front Axle Right  
 with spanner attachment

Length [mm] 380  
 Required quantity 2  
 Thread Size 1 M12x1,5  
 Thread Size 2 M12x1,5  
 replacement in pairs recommended



**References**

Land Rover LR030047  
 Land Rover RBM500200

Land Rover RBM000011

**Application info**

Land Rover Range Rover III (03/02-12/12)

**Stabilizer link**

53-16 060 0026/HD

MSL0925HD

**Notes**

Carbon Neutral  
Coupling Rod  
Front Axle Left  
Front Axle Right

Length [mm]

208

Required quantity

2

Thread Size 1

M14x2,0

Thread Size 2

M14x2,0

reinforced version

replacement in pairs recommended

**References**

Land Rover LR035489

**Application info**

Land Rover Defender II (09/19--)

Land Rover Range Rover IV (08/12--)

Land Rover Range Rover Sport II (04/13--)

**Stabilizer link**

53-16 060 0027/HD

MSL0926HD

**Notes**

Carbon Neutral  
Coupling Rod  
Rear Axle Left

Length [mm]

190

Paired article number

53-16 060 0028/HD | MSL0927HD

Required quantity

1

Thread Size 1

M14x2,0

Thread Size 2

M14x2,0

reinforced version

replacement in pairs recommended

**References**

Land Rover LR042976

**Application info**

Land Rover Range Rover IV (08/12--)

Land Rover Range Rover Sport II (04/13--)

**Stabilizer link****53-16 060 0028/HD****MSL0927HD****Notes**Carbon Neutral  
Coupling Rod  
Rear Axle RightLength [mm] 190  
Paired article number 53-16 060 0027/HD | MSL0926HD  
Required quantity 1  
Thread Size 1 M14x2,0  
Thread Size 2 M14x2,0  
reinforced version  
replacement in pairs recommended**References**

Land Rover LR042975

**Application info**

Land Rover Range Rover IV (08/12--)

Land Rover Range Rover Sport II (04/13--)

**Stabilizer link****53-16 060 0029/HD****MSL0928HD****Notes**Carbon Neutral  
Coupling Rod  
Rear Axle LeftLength [mm] 183  
Paired article number 53-16 060 0030/HD | MSL0929HD  
Required quantity 1  
Thread Size 1 M14x2,0  
Thread Size 2 M14x2,0  
reinforced version  
replacement in pairs recommended**References**

Land Rover LR033243

Land Rover LR048093

**Application info**

Land Rover Defender II (09/19--)

Land Rover Discovery V (09/16--)

Land Rover Range Rover IV (08/12--)

Land Rover Range Rover Sport II (04/13--)

**Stabilizer link****53-16 060 0030/HD****MSL0929HD****Notes**Carbon Neutral  
Coupling Rod  
Rear Axle RightLength [mm] 183  
Paired article number 53-16 060 0029/HD | MSL0928HD  
Required quantity 1  
Thread Size 1 M14x2,0  
Thread Size 2 M14x2,0  
reinforced version  
replacement in pairs recommended**References**

Land Rover LR033242

Land Rover LR048092

**Application info**

Land Rover Defender II (09/19--)

Land Rover Discovery V (09/16--)

Land Rover Range Rover IV (08/12--)

Land Rover Range Rover Sport II (04/13--)

**Stabilizer link****53-16 060 0031/HD****MSL1014HD****Notes**Carbon Neutral  
Coupling Rod  
Front Axle Left  
Front Axle RightLength [mm] 220  
Required quantity 2  
Thread Size 1 M12x1,5  
Thread Size 2 M12x1,5  
reinforced version  
replacement in pairs recommended**References**

Jaguar HK833B438AA

Jaguar T4A8238

Jeep K68273965AB

Jeep K68273965AC

Land Rover HK833B438AA

Land Rover LR090522

**Application info**

Jaguar F-Pace (X761) (09/15--)

Jaguar I-Pace (X590) (02/18--)

Jeep Compass (MP) (01/16--)

Land Rover Range Rover Velar (03/17--)

**Stabilizer link**

53-16 060 0032/HD

MSL1058HD

**Notes**

Carbon Neutral  
Coupling Rod  
Rear Axle Left  
Rear Axle Right

Length [mm]

186

Required quantity

2

Thread Size 1

M10x1,5

Thread Size 2

M10x1,5

reinforced version

replacement in pairs recommended

**References**

Jaguar HK835D498AB

Jaguar T4A2038

Land Rover HK835D498AB

Land Rover LR090549

**Application info**

Jaguar F-Pace (X761) (09/15--)

Jaguar I-Pace (X590) (02/18--)

Land Rover Range Rover Velar (03/17--)

**Stabilizer link**

53-16 060 0033/HD

MSL1080HD

**Notes**

Carbon Neutral  
Coupling Rod  
Rear Axle Left

Length [mm]

160

Paired article number

53-16 060 0034/HD | MSL1081HD

Required quantity

1

Thread Size 1

M10x1,5

Thread Size 2

M10x1,5

reinforced version



replacement in pairs recommended

**References**

Land Rover LR061272

**Application info**

Land Rover Discovery Sport (09/14--)

Stabilizer link		53-16 060 0034/HD	MSL1081HD
<p><b>Notes</b></p> <p>Carbon Neutral Coupling Rod Rear Axle Right</p> <p>Length [mm] 160</p> <p>Paired article number 53-16 060 0033/HD   MSL1080HD</p> <p>Required quantity 1</p> <p>Thread Size 1 M10x1,5</p> <p>Thread Size 2 M10x1,5</p> <p>reinforced version</p> <p>replacement in pairs recommended</p>			
<p><b>References</b></p> <p>Land Rover LR061271</p>			
<p><b>Application info</b></p> <p>Land Rover Discovery Sport (09/14--)</p>			
Stabilizer link		53-16 060 0035/HD	MSL1063HD
<p><b>Notes</b></p> <p>Carbon Neutral Coupling Rod Front Axle Left Front Axle Right</p> <p>Length [mm] 320</p> <p>Required quantity 2</p> <p>Thread Size 1 M10x1,5</p> <p>Thread Size 2 M10x1,5</p> <p>reinforced version</p> <p>replacement in pairs recommended</p>			
<p><b>References</b></p> <p>Land Rover LR114253</p>			
<p><b>Application info</b></p> <p>Land Rover Discovery Sport (09/14--)</p> <p>Land Rover Range Rover Evoque II (12/18--)</p>			



**Stabilizer link**

56-16 060 0000/HD

MSL0707HD

**Notes**

Carbon Neutral  
Coupling Rod  
Front Axle Left  
Front Axle Right  
with spanner attachment

Length [mm]

295

Required quantity

2

Thread Size 1

M12X1,5

Thread Size 2

M12X1,5

reinforced version

replacement in pairs recommended

**References**

Chevrolet 95299172

Chevrolet 95465758

Chevrolet 95941670

**Application info**

Chevrolet Aveo II (03/11--)

**Stabilizer link**

57-16 060 0000

MSL0514

**Notes**

Coupling Rod  
Front Axle Left  
Front Axle Right

Length [mm]

230

Required quantity

2

replacement in pairs recommended

**References**

Jeep 52089467AB

**Application info**

Jeep Grand Cherokee (WH) (10/04-10/11)

**Stabilizer link**

57-16 060 0007/HD

MSL1051HD

**Notes**

Carbon Neutral  
Coupling Rod  
Front Axle Left

Length [mm] 132.7

Paired article number 57-16 060 0008/HD | MSL1052HD

Required quantity 1

Thread Size 1 M12 X 1,5

Thread Size 2 M12 X 1,5

reinforced version

replacement in pairs recommended

**References**

Jeep 68069655AB

Jeep 68069655AC

Jeep K68069655AB

Jeep K68069655AC

**Application info**

Jeep Grand Cherokee IV (WK) (06/10--)

**Stabilizer link**

57-16 060 0008/HD

MSL1052HD

**Notes**

Carbon Neutral  
Coupling Rod  
Front Axle Right

Length [mm] 132.7

Paired article number 57-16 060 0007/HD | MSL1051HD

Required quantity 1

Thread Size 1 M12 X 1,5

Thread Size 2 M12 X 1,5

reinforced version

replacement in pairs recommended

**References**

Jeep 68069654AB

Jeep 68069654AC

Jeep K68069654AB

Jeep K68069654AC

**Application info**

Jeep Grand Cherokee IV (WK) (06/10--)

**Stabilizer link** 57-16 060 0011/HD MSL1132HD

**Notes**

Carbon Neutral  
Coupling Rod  
Front Axle Left  
Front Axle Right

Length [mm] 258  
Required quantity 2  
Thread Size 1 10x1,5  
Thread Size 2 10x1,5  
replacement in pairs recommended



**References**

Jeep 68224732AA	Jeep 68224732AB
Jeep 68224732AC	Jeep 68224732AD
Jeep K68224732AA	Jeep K68224732AB
Jeep K68224732AC	Jeep K68224732AD

**Application info**

Jeep Cherokee (KL) (06/13--)

**Stabilizer link** 57-16 060 0012/HD MSL1133HD

**Notes**

Carbon Neutral  
Coupling Rod  
Front Axle Left  
Front Axle Right

Length [mm] 245  
Required quantity 2  
Thread Size 1 10x1,5  
Thread Size 2 10x1,5  
replacement in pairs recommended



**References**

Jeep 68224731AB	Jeep 68224731AC
Jeep 68224731AD	Jeep K68224731AB
Jeep K68224731AD	

**Application info**

Jeep Cherokee (KL) (06/13--)

**Stabilizer link**

57-16 060 0015/HD

MSL1086HD

**Notes**

Carbon Neutral  
Coupling Rod  
Rear Axle Left  
Rear Axle Right

Length [mm]

117

Required quantity

2

Thread Size 1

12x1,5

Thread Size 2

12x1,5

reinforced version

replacement in pairs recommended

**References**

Jeep 68069682AA

Jeep 68298923AA

Jeep K68069682AA

Jeep K68298923AA

Jeep KV8069682AA

Jeep V8069682AA

**Application info**

Jeep Grand Cherokee IV (WK) (06/10--)

**Stabilizer link**

57-16 060 0016/HD

MSL1138HD

**Notes**

Carbon Neutral  
Coupling Rod  
Front Axle Left  
Front Axle Right

Length [mm]

130

Required quantity

2

Thread Size 1

M12x1,75

replacement in pairs recommended

**References**

Jeep 52059975AB

Jeep 52059975AC

Jeep 53132015

Jeep 6000100211

Jeep K52059975AB

Jeep K52059975AC

Jeep KV2059975AC

**Application info**

Jeep Wrangler (JK) (06/06--)

**Stabilizer link**

57-16 060 0018/HD

MSL1140HD

**Notes**

Carbon Neutral  
Coupling Rod  
Rear Axle Left  
Rear Axle Right

Diameter [mm] 12.1  
Length [mm] 222.8  
Pipe Diameter [mm] 12  
Required quantity 2  
Thread Size 1 M12x1,5  
replacement in pairs recommended

**References**

Jeep 52060011AB  
Jeep K52060011AB

Jeep 53150109  
Jeep KV2060011AB

**Application info**

Jeep Wrangler (JK) (06/06--)

**Stabilizer link**

57-16 060 0019/HD

MSL1128HD

**Notes**

Carbon Neutral  
Coupling Rod  
Rear Axle Left  
Rear Axle Right

Length [mm] 107  
Required quantity 2  
Thread Size 1 12x1,5  
Thread Size 2 12x1,5  
replacement in pairs recommended

**References**

Jeep 05168176AA  
Jeep 68253391AA  
Jeep K68091853AA

Jeep 68091853AA  
Jeep 68298921AA  
Jeep K68298921AA

**Application info**

Jeep Grand Cherokee IV (WK) (06/10--)

**Stabilizer link****57-16 060 0020/HD****MSL1136HD****Notes**

Carbon Neutral  
Coupling Rod  
Front Axle Right  
Lower

Length [mm]

119

Paired article number

57-16 060 0021/HD | MSL1137HD

Required quantity

1

Thread Size 1

M12X1,5

Thread Size 2

M12X1,5

replacement in pairs recommended

**References**

Jeep 68091836AA

Jeep 68091836AB

Jeep K68091836AA

Jeep K68091836AB

**Application info**

Jeep Grand Cherokee IV (WK) (06/10--)

**Stabilizer link****57-16 060 0021/HD****MSL1137HD****Notes**

Carbon Neutral  
Coupling Rod  
Front Axle Left  
Lower

Length [mm]

119

Paired article number

57-16 060 0020/HD | MSL1136HD

Required quantity

1

Thread Size 1

M12x1,5

Thread Size 2

M12X1,5

replacement in pairs recommended

**References**

Jeep 68091837AA

Jeep 68091837AB

Jeep K68091837AA

Jeep K68091837AB

**Application info**

Jeep Grand Cherokee IV (WK) (06/10--)

## Stabilizer link

57-16 060 0022/HD

MSL1134HD

## Notes

Carbon Neutral  
Coupling Rod  
Front Axle Left  
Front Axle Right

Length [mm]

280

Required quantity

2

Thread Size 1

10x1,5

Thread Size 2

10x1,5

reinforced version

replacement in pairs recommended



## References

Jeep 68232186AA

Jeep 68232186AB

Jeep 68232186AC

Jeep K68232186AA

Jeep K68232186AC

Jeep V8164037AA

## Application info

Jeep Cherokee (KL) (06/13--)

## Stabilizer link

57-16 060 0024/HD

MSL1157HD

## Notes

Carbon Neutral  
Coupling Rod  
Rear Axle Left  
Rear Axle Right  
Steel

Inner Diameter [mm]

12.1

Length [mm]

222.5

Required quantity

2

Thread Size

M12x1,5

Thread Size 1

M12X1,5

reinforced version

replacement in pairs recommended



## References

Jeep 68293034AA

Jeep 68293034AB

Jeep 68445126AA

Jeep K68293034AA

Jeep K68293034AB

Jeep K68445126AA

## Application info

Jeep Wrangler (JL) (11/17--)

## Stabilizer link

616 060 0003/HD

MSL0518HD

## Notes

Carbon Neutral  
Coupling Rod  
Front Axle Left  
Front Axle Right  
Steel  
with spanner attachment

Length [mm] 300  
Required quantity 2  
Thread Size 1 M12X1,5  
Thread Size 2 M12X1,5  
reinforced version  
replacement in pairs recommended



## References

Chevrolet 13169439	Chevrolet 13219141
Chevrolet 13258052	Chevrolet 90498745
GENERAL MOTORS 13169439	GENERAL MOTORS 13219141
GENERAL MOTORS 13258052	GENERAL MOTORS 13327928
GENERAL MOTORS 90498745	
Opel 03 50 614	Opel 03 50 611
Opel 03 50 618	Opel 03 50 617
Opel 3 50 611	Opel 3 50 176
Opel 3 50 617	Opel 3 50 614
Opel 35 01 760	Opel 3 50 618
Vauxhall 03 50 611	Saab 13 21 9141
Vauxhall 03 50 617	Vauxhall 03 50 614
Vauxhall 3 50 176	Vauxhall 03 50 618
Vauxhall 3 50 614	Vauxhall 3 50 611
Vauxhall 3 50 618	Vauxhall 3 50 617



**Application info**

Chevrolet Cruze (J300, J305) (07/00--)	Chevrolet Cruze (J308) (08/12--)
Chevrolet Orlando (J309) (12/10--)	Chevrolet Volt (04/11--)
Chevrolet Zafira (F75) (02/99-12/12)	Opel Ampera (11/11-03/15)
Opel Astra G / Astra Classic / Zafira A (02/98-12/09)	Opel Astra H / Zafira B (01/04-05/19)
Opel Astra J (12/06--)	Opel Insignia A (07/08-03/17)
Opel Meriva B (06/10-03/17)	Opel Zafira C (Tourer) (10/11--)
Saab 9-5 (YS3G) (01/10-01/12)	Vauxhall Ampera (03/12--)
Vauxhall Astra Mk II (09/84-09/93)	Vauxhall Astra Mk IV (01/93-08/06)
Vauxhall Astra Mk V (01/04--)	Vauxhall Astra Mk VI (12/09-10/15)
Vauxhall Insignia Mk I A (07/08-05/17)	Vauxhall Meriva Mk II B (06/10--)
Vauxhall Zafira Mk I (11/98-08/05)	Vauxhall Zafira Mk II (04/05-11/14)
Vauxhall Zafira Mk III (10/11-08/18)	

**Stabilizer link****616 060 0004/HD****MSL0519HD****Notes**

Carbon Neutral  
Coupling Rod  
Front Axle Left  
Front Axle Right  
with spanner attachment

Length [mm]

354

Required quantity

2

Thread Size 1

M12X1,5

Thread Size 2

M12X1,5

reinforced version

replacement in pairs recommended





**References**

Fiat 51741130	Fiat 51803183
GENERAL MOTORS 13237130	GENERAL MOTORS 24417251
Opel 03 50 603	Opel 03 50 615
Opel 3 50 603	Opel 3 50 615
Saab 13-23-7130	Saab 24 41 7251
Vauxhall 03 50 603	Vauxhall 03 50 615
Vauxhall 3 50 603	Vauxhall 3 50 615

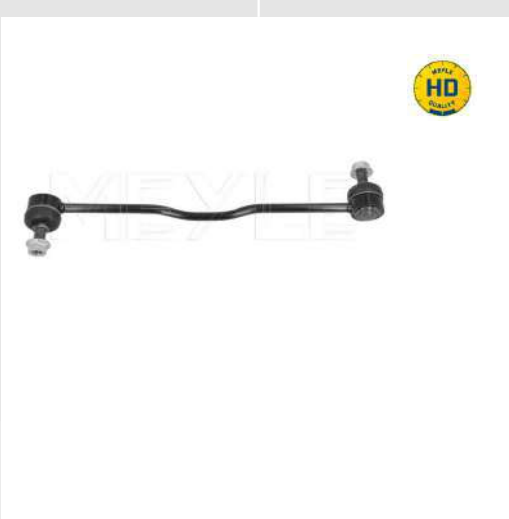
**Application info**

Fiat Croma II (06/05--)	Opel Vectra C / Signum (04/02-01/09)
Saab 9-3 (YS3F) (09/02-02/15)	Vauxhall Vectra Mk II / Signum (01/00-05/09)

Stabilizer link		616 060 0005	MSL0520
<b>Notes</b>  Coupling Rod Front Axle Left Front Axle Right for vehicles with IDS-plus suspension  Length [mm] 300 Required quantity 2 Thread Size 1 M12x1,5 Thread Size 2 M12x1,5 replacement in pairs recommended			
<b>References</b> GENERAL MOTORS 24461353 Opel 03 50 613 Opel 3 50 613 Opel 35 06 130 Vauxhall 03 50 613 Vauxhall 3 50 613			
<b>Application info</b> Opel Astra H / Zafira B (01/04-05/19) Opel Astra J (12/06--) Vauxhall Astra Mk V (01/04--) Vauxhall Insignia Mk I A (07/08-05/17) Vauxhall Zafira Mk II (04/05-11/14)			
Stabilizer link		616 060 0006/HD	MSL0521HD
<b>Notes</b>  Carbon Neutral Coupling Rod Front Axle Left Front Axle Right with spanner attachment  Length [mm] 355 Required quantity 2 Thread Size 1 M12X1,5 Thread Size 2 M12X1,5 reinforced version replacement in pairs recommended			
<b>References</b> GENERAL MOTORS 13116332 Opel 03 50 612 Opel 3 50 612 Vauxhall 03 50 612 Vauxhall 3 50 612			
<b>Application info</b> Opel Vectra C / Signum (04/02-01/09) Vauxhall Vectra Mk II / Signum (01/00-05/09)			

Stabilizer link		616 060 0007/HD	MSL0522HD
<b>Notes</b>  Carbon Neutral Coupling Rod Front Axle Left with spanner attachment  Length [mm] 130 Paired article number 616 060 0008/HD   MSL0523HD Required quantity 1 Thread Size 1 M10x1,5 Thread Size 2 M10x1,5 reinforced version replacement in pairs recommended		 	
<b>References</b> GENERAL MOTORS 9160498 Nissan 54616-00Q0C Opel 44 18 192 Renault 7700302165 Renault 8200713522 Vauxhall 45 00 198 GENERAL MOTORS 93192673 Nissan 54616-00QAB Opel 45 00 198 Renault 7700309070 Vauxhall 44 18 192			
<b>Application info</b> Nissan Interstar I (X70) (04/02--) Renault Master II (03/98--) Opel Movano A (07/98--) Vauxhall Movano Mk I (10/98-12/10)			
Stabilizer link		616 060 0008/HD	MSL0523HD
<b>Notes</b>  Carbon Neutral Coupling Rod Front Axle Right with spanner attachment  Length [mm] 130 Paired article number 616 060 0007/HD   MSL0522HD Required quantity 1 Thread Size 1 M10x1,5 Thread Size 2 M10x1,5 reinforced version replacement in pairs recommended		 	

**References**

GENERAL MOTORS 9160499  
 Nissan 54618-00Q0A  
 Opel 44 18 193  
 Renault 7700307343  
 Renault 8200713523  
 Vauxhall 45 00 199

GENERAL MOTORS 93192674  
 Nissan 54618-00QAA  
 Opel 45 00 199  
 Renault 7700309071  
 Vauxhall 44 18 193

**Application info**

Nissan Interstar I (X70) (04/02--)  
 Renault Master II (03/98--)

Opel Movano A (07/98--)  
 Vauxhall Movano Mk I (10/98-12/10)

**Stabilizer link****616 060 0012/HD****MSL0526HD****Notes**

Carbon Neutral  
 Coupling Rod  
 Front Axle Left  
 Front Axle Right  
 with spanner attachment

Length [mm] 301  
 Required quantity 2  
 Thread Size 1 M10x1,5  
 Thread Size 2 M10x1,5  
 reinforced version  
 replacement in pairs recommended

**References**



Alfa Romeo 50515276  
 Alfa Romeo 51805870  
 Fiat 50515276  
 Fiat 51805870  
 GENERAL MOTORS 13321280  
 Lancia 50515276  
 Opel 3 50 175  
 Vauxhall 03 50 616

Alfa Romeo 50531823  
 Alfa Romeo 55700753  
 Fiat 50531823  
 Fiat 55700753  
 GENERAL MOTORS 55700753  
 Opel 03 50 616  
 Opel 3 50 616  
 Vauxhall 3 50 616

**Application info**

ABARTH Grande Punto (12/07-12/12)  
 Alfa Romeo Giulietta (940) (04/10--)  
 Fiat 500L (09/12--)  
 Fiat Punto Evo (07/08--)  
 Opel Corsa D (07/06-08/14)  
 Vauxhall Corsa Mk III (07/06-08/14)

ABARTH Punto III (03/12--)  
 Alfa Romeo Mito (08/08--)  
 Fiat Grande Punto (06/05--)  
 Fiat Punto III (01/12--)  
 Vauxhall Combo Mk III (07/06--)

Stabilizer link		616 060 0013	MSL0527
<b>Notes</b>  Coupling Rod Front Axle Left  Length [mm] 287 Paired article number 616 060 0014   MSL0528 Required quantity 1 Thread Size 1 M12x1,75 Thread Size 2 M12x1,75 replacement in pairs recommended			
<b>References</b> Chevrolet 22744118      Chevrolet 95488870 Chevrolet 96626247      Chevrolet 96996450 GENERAL MOTORS 22744118      GENERAL MOTORS 95488870 GENERAL MOTORS 96626247      GENERAL MOTORS 96996450 Opel 48 02 966      Opel 48 06 304 Opel 48 17 516      Opel 48 19 611 Vauxhall 48 02 966      Vauxhall 48 06 304 Vauxhall 48 17 516			
<b>Application info</b> Chevrolet Captiva I (06/06--) Opel Antara (05/06--) Vauxhall Antara (08/06--) 			
Stabilizer link		616 060 0014	MSL0528
<b>Notes</b>  Coupling Rod Front Axle Right  Length [mm] 287 Paired article number 616 060 0013   MSL0527 Required quantity 1 Thread Size 1 M12x1,75 Thread Size 2 M12x1,75 replacement in pairs recommended			

**References**

Chevrolet 22744119

Chevrolet 96626248

GENERAL MOTORS 22744119

GENERAL MOTORS 96626248

Opel 48 02 967

Opel 48 17 515

Vauxhall 48 06 305

Chevrolet 95488871

Chevrolet 96996451

GENERAL MOTORS 95488871

GENERAL MOTORS 96996451

Opel 48 06 305

Opel 48 19 612

**Application info**

Chevrolet Captiva I (06/06--)

Vauxhall Antara (08/06--)

Opel Antara (05/06--)

**Stabilizer link****616 060 0016/HD****MSL0529HD****Notes**

Carbon Neutral  
Coupling Rod  
Front Axle Left  
with spanner attachment

290

616 060 0017/HD | MSL0530HD

1

M12x1,75

M12x1,75

Length [mm]

Paired article number

Required quantity

Thread Size 1

Thread Size 2

reinforced version

replacement in pairs recommended

**References**

GENERAL MOTORS 13282834

Opel 3 50 192

Opel 03 50 192

Vauxhall 3 50 192



**Application info**

Opel Astra J (12/06--)

Vauxhall Astra Mk VI (12/09-10/15)

Opel Cascada (03/13-04/19)

Vauxhall Cascada (02/13--)

Stabilizer link		616 060 0017/HD	MSL0530HD
<b>Notes</b>  Carbon Neutral Coupling Rod Front Axle Right with spanner attachment  Length [mm] 290 Paired article number 616 060 0016/HD   MSL0529HD Required quantity 1 Thread Size 1 M12x1,75 Thread Size 2 M12x1,75 reinforced version replacement in pairs recommended			
<b>References</b> GENERAL MOTORS 13285628 Opel 03 50 193 Opel 3 50 193 Vauxhall 3 50 193			
<b>Application info</b> Opel Astra J (12/06--) Opel Cascada (03/13-04/19) Vauxhall Astra Mk VI (12/09-10/15) Vauxhall Cascada (02/13--) 			
Stabilizer link		616 060 0018/HD	MSL0531HD
<b>Notes</b>  Carbon Neutral Coupling Rod Front Axle Left with spanner attachment  Length [mm] 285 Paired article number 616 060 0019/HD   MSL0532HD Required quantity 1 Thread Size 1 M12x1,5 Thread Size 2 M12x1,5 reinforced version replacement in pairs recommended			
<b>References</b> Chevrolet 3 50 231 Chevrolet 95942519 GENERAL MOTORS 95942519 Opel 03 50 231 Opel 3 50 231 Vauxhall 3 50 231 Vauxhall 95 94 2519			

**Application info**

Chevrolet Trax (12/12--)  
Vauxhall Mokka A (06/12--)

Opel Mokka A (06/12--)

**Stabilizer link****616 060 0019/HD****MSL0532HD****Notes**

Carbon Neutral  
Coupling Rod  
Front Axle Right  
with spanner attachment

Length [mm]

285

Paired article number

616 060 0018/HD | MSL0531HD

Required quantity

1

Thread Size 1

M12x1,5

Thread Size 2

M12x1,5

reinforced version

replacement in pairs recommended

**References**

Chevrolet 3 50 232

GENERAL MOTORS 95942520

Opel 3 50 232

Vauxhall 95 94 2520

Chevrolet 95942520

Opel 03 50 232

Vauxhall 3 50 232

**Application info**

Chevrolet Trax (12/12--)  
Vauxhall Mokka A (06/12--)

Opel Mokka A (06/12--)

**Stabilizer link****616 060 0020/HD****MSL0567HD****Notes**

Carbon Neutral  
Coupling Rod  
Rear Axle Left  
Rear Axle Right

Length [mm]

167

Required quantity

2

Thread Size 1

M12x1,75

Thread Size 2

M10x1,5

reinforced version

replacement in pairs recommended





**References**

Chevrolet 22737680

GENERAL MOTORS 22737680

Opel 48 08 136

Vauxhall 48 08 136

GENERAL MOTORS 20911128

Opel 48 01 837

Vauxhall 48 01 837

**Application info**

Chevrolet Captiva I (06/06--)

Vauxhall Mokka A (06/12--)

Opel Mokka A (06/12--)

**Stabilizer link****616 060 0021/HD****MSL0647HD****Notes**

Carbon Neutral  
Coupling Rod  
Rear Axle Left  
Rear Axle Right  
with dual tyres

Length [mm]

165

Required quantity

2

Thread Size 1

M10x1,5

reinforced version

replacement in pairs recommended

**References**

GENERAL MOTORS 93168675

Opel 44 20 954

Vauxhall 93168675

Nissan 56261-00Q0C

Renault 551100020R



**Application info**

Nissan NV400 (11/11--)

Renault Master III (02/10--)

Opel Movano B (05/10--)

Vauxhall Movano Mk II (05/10--)

Stabilizer link		616 060 0022/HD	MSL0582HD
<b>Notes</b>  Carbon Neutral Coupling Rod Front Axle Left Front Axle Right with spanner attachment  Length [mm] 310 Required quantity 2 Thread Size 1 M10X1,5 Thread Size 2 M10x1,5 reinforced version replacement in pairs recommended			
<b>References</b> GENERAL MOTORS 13391512 Opel 3 50 233 Suzuki 42420-74P00 Suzuki 42420-74P10 Suzuki 42420-74P10-000 Vauxhall 13391512			
<b>Application info</b> Opel Adam (10/12-02/19) Opel Corsa E (09/14--) Suzuki Ignis III (MF) (10/16--) Vauxhall Adam (10/12-04/19) Vauxhall Corsa Mk IV (08/14--)			
Stabilizer link		616 060 0023	MSL0692
<b>Notes</b>  Coupling Rod Rear Axle Left Rear Axle Right  Length [mm] 71.5 Required quantity 2 Thread Size 10x1,5 replacement in pairs recommended			
<b>References</b> Chevrolet 13281792 GENERAL MOTORS 13281792 Opel 13281792 Opel 4 44 081			
<b>Application info</b> Opel Insignia A (07/08-03/17) Vauxhall Insignia Mk I A (07/08-05/17)			

**Stabilizer link****616 060 0028****MSL0879****Notes**

Coupling Rod  
 Front Axle Left  
 Front Axle Right  
 Steel  
 with spanner attachment

Length [mm]

300

Required quantity

2

Thread Size 1

M12X1,5

Thread Size 2

M12X1,5

replacement in pairs recommended

**References**

GENERAL MOTORS 13169439

GENERAL MOTORS 13327928

GENERAL MOTORS 90498745

Opel 03 50 611

Opel 03 50 614

Opel 3 50 176

Opel 3 50 611

Opel 3 50 614

Vauxhall 03 50 611

Vauxhall 03 50 614

Vauxhall 3 50 176

Vauxhall 3 50 611

Vauxhall 3 50 614

**Application info**

Opel Astra G / Astra Classic / Zafira A (02/98-12/09)

Opel Astra H / Zafira B (01/04-05/19)

Opel Astra J (12/06--)

Opel Meriva B (06/10-03/17)

Vauxhall Astra Mk II (09/84-09/93)

Vauxhall Astra Mk IV (01/93-08/06)

Vauxhall Astra Mk V (01/04--)

Vauxhall Meriva Mk II B (06/10--)

Vauxhall Zafira Mk I (11/98-08/05)

Vauxhall Zafira Mk II (04/05-11/14)

**Stabilizer link****616 060 0029****MSL0880****Notes**

Coupling Rod  
 Front Axle Left  
 Front Axle Right  
 with spanner attachment

Length [mm]

354

Required quantity

2

Thread Size 1

M12X1,5

Thread Size 2

M12X1,5

replacement in pairs recommended



**References**

Fiat 51741130

GENERAL MOTORS 13237130

Opel 03 50 603

Opel 3 50 603

Saab 13-23-7130

Vauxhall 03 50 603

Vauxhall 3 50 603

Fiat 51803183

GENERAL MOTORS 24417251

Opel 03 50 615

Opel 3 50 615

Saab 24 41 7251

Vauxhall 03 50 615

Vauxhall 3 50 615

**Application info**

Fiat Croma II (06/05--)

Saab 9-3 (YS3F) (09/02-02/15)

Opel Vectra C / Signum (04/02-01/09)

Vauxhall Vectra Mk II / Signum (01/00-05/09)

**Stabilizer link****616 060 0030****MSL0881****Notes**

Coupling Rod  
 Front Axle Left  
 Front Axle Right  
 with spanner attachment

Length [mm]

301

Required quantity

2

Thread Size 1

M10x1,5

Thread Size 2

M10x1,5

replacement in pairs recommended

**References**

GENERAL MOTORS 13321280

Opel 03 50 616

Opel 3 50 616

Vauxhall 3 50 616

GENERAL MOTORS 55700753

Opel 3 50 175



Vauxhall 03 50 616

**Application info**

Opel Corsa D (07/06-08/14)

Vauxhall Corsa Mk III (07/06-08/14)

Vauxhall Combo Mk III (07/06--)

Stabilizer link		616 060 0032	MSL0882
<b>Notes</b>  Coupling Rod Front Axle Left Front Axle Right Steel with spanner attachment  Length [mm] 300 Required quantity 2 Thread Size 1 M12X1,5 Thread Size 2 M12X1,5 replacement in pairs recommended			
<b>References</b> Chevrolet 13219141 GENERAL MOTORS 13219141 Opel 03 50 617 Opel 3 50 617 Saab 13 21 9141 Vauxhall 03 50 617 Vauxhall 3 50 617		Chevrolet 13258052 GENERAL MOTORS 13258052 Opel 03 50 618 Opel 3 50 618 Saab 13 25 8052 Vauxhall 03 50 618 Vauxhall 3 50 618	
<b>Application info</b> Chevrolet Cruze (J300, J305) (07/00--) Chevrolet Orlando (J309) (12/10--) Chevrolet Zafira (F75) (02/99-12/12) Opel Astra J (12/06--) Opel Zafira C (Tourer) (10/11--) Vauxhall Ampera (03/12--) Vauxhall Insignia Mk I A (07/08-05/17)		Chevrolet Cruze (J308) (08/12--) Chevrolet Volt (04/11--) Opel Ampera (11/11-03/15) Opel Insignia A (07/08-03/17) Saab 9-5 (YS3G) (01/10-01/12) Vauxhall Astra Mk VI (12/09-10/15) Vauxhall Zafira Mk III (10/11-08/18)	
Stabilizer link		616 060 0035	MSL0884
<b>Notes</b>  Coupling Rod Front Axle Left Front Axle Right with spanner attachment  Length [mm] 224 Required quantity 2 Thread Size 1 M12X1,5 Thread Size 2 M12X1,5 replacement in pairs recommended			

**References**

GENERAL MOTORS 90334075  
 GENERAL MOTORS 90468930  
 Opel 03 50 605  
 Opel 3 50 600  
 Opel 3 50 609  
 Vauxhall 03 50 605  
 Vauxhall 3 50 600  
 Vauxhall 3 50 609

GENERAL MOTORS 90445137  
 Opel 03 50 600  
 Opel 03 50 609  
 Opel 3 50 605  
 Vauxhall 03 50 600  
 Vauxhall 03 50 609  
 Vauxhall 3 50 605

**Application info**

Opel Omega A / Senator B (09/86-05/94)  
 Vauxhall Carlton Mk III (09/86-03/94)  
 Vauxhall Senator Mk II (09/87-09/93)

Opel Omega B (03/94-12/05)  
 Vauxhall Omega Mk II (12/93-07/03)

**Stabilizer link****616 060 0036/HD****MSL0949HD****Notes**

Carbon Neutral  
 Coupling Rod  
 Front Axle Right  
 Length [mm] 307  
 Paired article number 616 060 0037/HD | MSL0950HD  
 Required quantity 1  
 Thread Size 1 12x1,5  
 Thread Size 2 12x1,5  
 reinforced version  
 replacement in pairs recommended

**References**

GENERAL MOTORS 39001004  
 GENERAL MOTORS 42705814  
 Opel 39 06 4481  
 Vauxhall 39 00 1004  
 Vauxhall 42 70 5814

GENERAL MOTORS 39064481  
 Opel 39 00 1004  
 Opel 42 70 5814  
 Vauxhall 39 06 4481

**Application info**

Opel Astra K (06/15--)

Vauxhall Astra Mk VII (07/15--)

**Stabilizer link****616 060 0037/HD****MSL0950HD****Notes**Carbon Neutral  
Coupling Rod  
Front Axle LeftLength [mm] 307  
Paired article number 616 060 0036/HD | MSL0949HD  
Required quantity 1  
Thread Size 1 12x1,5  
Thread Size 2 12x1,5  
reinforced version  
replacement in pairs recommended**References**GENERAL MOTORS 39001003  
GENERAL MOTORS 42705813  
Opel 39 06 4480  
Vauxhall 39 00 1003  
Vauxhall 42 70 5813GENERAL MOTORS 39064480  
Opel 39 00 1003  
Opel 42705813  
Vauxhall 39 06 4480**Application info**

Opel Astra K (06/15--)

Vauxhall Astra Mk VII (07/15--)



**Stabilizer link****616 060 0038****MSL0980****Notes**Coupling Rod  
Rear Axle Left  
Rear Axle RightDiameter [mm] 10  
Length [mm] 100  
Required quantity 2  
replacement in pairs recommended**References**GENERAL MOTORS 23384634  
Vauxhall 23 38 4634

Opel 23384634

**Application info**

Opel Insignia B (03/17--)

Vauxhall Insignia Mk II B (03/17--)

Stabilizer link		616 060 0039	MSL0983
<b>Notes</b>  Coupling Rod Front Axle Left  Length [mm] 273 Paired article number 616 060 0040   MSL0984 Required quantity 1 Thread Size 1 M12 X 1,75 Thread Size 2 M12 X 1,75 replacement in pairs recommended			
<b>References</b> GENERAL MOTORS 84077102 Opel 84077102 Vauxhall 84 07 7102			
<b>Application info</b> Opel Insignia B (03/17--) Vauxhall Insignia Mk II B (03/17--)			
Stabilizer link		616 060 0040	MSL0984
<b>Notes</b>  Coupling Rod Front Axle Right  Length [mm] 273 Paired article number 616 060 0039   MSL0983 Required quantity 1 Thread Size 1 M12 X 1,75 Thread Size 2 M12 X 1,75 replacement in pairs recommended			
<b>References</b> GENERAL MOTORS 84077103 Opel 84077103 Vauxhall 84 07 7103			
<b>Application info</b> Opel Insignia B (03/17--) Vauxhall Insignia Mk II B (03/17--)			



**Stabilizer link**

616 060 0041/HD

MSL1055HD

**Notes**

Carbon Neutral  
Coupling Rod  
Front Axle Left  
Front Axle Right

Length [mm]

240

Required quantity

2

Thread Size 1

M10 X 1,5

Thread Size 2

M10 X 1,5

reinforced version

replacement in pairs recommended

**References**

GENERAL MOTORS 95167261

Opel 3 50 239

Vauxhall 95 16 7261

**Application info**

Opel Karl (01/15-03/19)

Vauxhall Viva (01/15-03/19)

**Stabilizer link**

616 060 1001/S

MSL0533

**Notes**

Coupling Rod  
Front Axle Left  
Front Axle Right  
Set  
for vehicles with heavy duty suspension

Inner Diameter 1 [mm]

21

Length [mm]

85

Required quantity

2

Thread Size 1

M8x1,25

replacement in pairs recommended

**References**

GENERAL MOTORS 90278579

Opel 03 50 260

Opel 3 50 260

Saab 30 54 0743

Vauxhall 03 50 260

Vauxhall 3 50 260

**Application info**

Opel Astra F (09/91-01/05)

Opel Calibra (08/89-07/97)

Opel Vectra A (04/88-12/95)

Saab 900 II (07/93-04/99)

Vauxhall Astra Mk III (01/91-03/01)

Vauxhall Calibra Mk I (06/90-07/97)

Vauxhall Cavalier Mk III (08/88-11/95)

**Stabilizer link**

616 060 1002/S

MSL0534

**Notes**

Coupling Rod  
 Front Axle Left  
 Front Axle Right  
 Set

Inner Diameter 1 [mm]

17

Length [mm]

85

Required quantity

2

Thread Size 1

M8x1,25

replacement in pairs recommended

**References**

GENERAL MOTORS 90278577

Opel 03 50 261

Opel 3 50 261

Vauxhall 03 50 261

Vauxhall 3 50 261

**Application info**

Opel Astra F (09/91-01/05)

Opel Vectra A (04/88-12/95)

Vauxhall Astra Mk III (01/91-03/01)

Vauxhall Cavalier Mk III (08/88-11/95)

**Stabilizer link**

616 060 5389

MSL0535

**Notes**

Coupling Rod

Length [mm]

195

Required quantity

2

Thread Size 1

M10x1,5

Thread Size 2

M10x1,5

replacement in pairs recommended

**References**

Chevrolet 96440020

Daewoo 96440020

GENERAL MOTORS 90236577

Opel 03 50 602

Opel 3 50 602

Vauxhall 03 50 602

Vauxhall 3 50 602

**Application info**

Chevrolet Evanda (03/05--)

Daewoo Evanda / Magnus (08/02--)

Opel Monza / Senator (02/78-08/87)

Opel Record E (08/77-08/86)

**Stabilizer link**

616 060 5575/HD

MSL0538HD

**Notes**

Carbon Neutral  
Coupling Rod  
Front Axle Left  
Front Axle Right  
with spanner attachment

Length [mm]

224

Required quantity

2

Thread Size 1

M12X1,5

Thread Size 2

M12X1,5

reinforced version

replacement in pairs recommended

**References**

GENERAL MOTORS 90334075

GENERAL MOTORS 90468930

Opel 03 50 605

Opel 3 50 600

Opel 3 50 609

Vauxhall 03 50 605

Vauxhall 3 50 600

Vauxhall 3 50 609

GENERAL MOTORS 90445137

Opel 03 50 600

Opel 03 50 609

Opel 3 50 605

Vauxhall 03 50 600

Vauxhall 03 50 609

Vauxhall 3 50 605

**Application info**

Opel Omega A / Senator B (09/86-05/94)

Vauxhall Carlton Mk III (09/86-03/94)

Vauxhall Senator Mk II (09/87-09/93)

Opel Omega B (03/94-12/05)

Vauxhall Omega Mk II (12/93-07/03)

**Stabilizer link**

616 060 5582/HD

MSL0539HD

**Notes**

Carbon Neutral  
Coupling Rod  
Front Axle Left  
Front Axle Right  
with spanner attachment

Length [mm]

243

Required quantity

2

Thread Size 1

M12X1,5

Thread Size 2

M12X1,5

reinforced version

replacement in pairs recommended



**References**

GENERAL MOTORS 90496116

Opel 3 50 610

Saab 52 36 823

Vauxhall 3 50 610

Opel 03 50 610

Saab 46 86 606

Vauxhall 03 50 610

**Application info**

Opel Corsa C / Combo / Tigra (09/00--)

Opel Vectra B (09/95-07/04)

Saab 9-5 (YS3G) (01/10-01/12)

Vauxhall Corsa Mk II / Tigra / Combo (08/00-02/12)

Vauxhall Vectra Mk I (08/95-07/03)

Opel Meriva A (05/03-05/10)

Saab 9-5 (YS3E) (09/97-12/09)

Vauxhall Combo Mk II (09/01-02/12)

Vauxhall Meriva Mk I A (01/03-06/10)

**Stabilizer link****616 060 5582****MSL0539****Notes**Coupling Rod  
Front Axle Left  
Front Axle Right

Length [mm]

243

Required quantity

2

Thread Size 1

M12x1,5

Thread Size 2

M12x1,5

replacement in pairs recommended

**References**

GENERAL MOTORS 90496116

Opel 90496116

Saab 52 36 823

Vauxhall 3 50 610

Opel 03 50 610

Saab 46 86 606

Vauxhall 03 50 610

**Application info**

Opel Corsa C / Combo / Tigra (09/00--)

Opel Vectra B (09/95-07/04)

Vauxhall Combo Mk II (09/01-02/12)



Vauxhall Meriva Mk I A (01/03-06/10)



Opel Meriva A (05/03-05/10)



Saab 9-5 (YS3E) (09/97-12/09)

Vauxhall Corsa Mk II / Tigra / Combo (08/00-02/12)

Vauxhall Vectra Mk I (08/95-07/03)

Stabilizer link		70-16 060 0000/HD	MSL1183HD
<b>Notes</b>  Carbon Neutral Coupling Rod Front Axle Left Front Axle Right  Length [mm] 269.5 Required quantity 2 Thread Size 1 M10x1,5 Thread Size 2 M10x1,5 reinforced version replacement in pairs recommended			
<b>References</b> TESLA 1027391-00-B			
<b>Application info</b> TESLA Model X (09/13--)			
Stabilizer link		70-16 060 0002/HD	MSL1186HD
<b>Notes</b>  Carbon Neutral Coupling Rod Rear Axle Left Rear Axle Right  Length [mm] 140.8 Pipe Diameter [mm] 10 Required quantity 2 Thread Size 1 M10x1,5 Thread Size 2 M10x1,5 replacement in pairs recommended			
<b>References</b> TESLA 1027491-00-A			
<b>Application info</b> TESLA Model X (09/13--)			

Stabilizer link		70-16 060 0005/HD	MSL1177HD
<b>Notes</b>  Carbon Neutral Coupling Rod Front Axle Left Front Axle Right  Length [mm] 229 Required quantity 2 Thread Size 1 M10x1,5 Thread Size 2 M10x1,5 reinforced version replacement in pairs recommended			
<b>References</b> TESLA 1030603-00-B			
<b>Application info</b> TESLA Model S (09/12--)			
Stabilizer link		70-16 060 0008/HD	MSL1115HD
<b>Notes</b>  Carbon Neutral Coupling Rod Front Axle Left  Length [mm] 281 Paired article number 70-16 060 0009/HD   MSL1116HD Required quantity 1 Thread Size 1 M12x1,5 Thread Size 2 M12x1,5 reinforced version replacement in pairs recommended			
<b>References</b> TESLA 1044391-00-C TESLA 1188391-00-B TESLA 1044391-00-D			
<b>Application info</b> TESLA Model 3 (01/17--) TESLA Model Y (03/19--)			

Stabilizer link		70-16 060 0009/HD	MSL1116HD
<b>Notes</b>  Carbon Neutral Coupling Rod Front Axle Right  Length [mm] 281 Paired article number 70-16 060 0008/HD   MSL1115HD Required quantity 1 Thread Size 1 M12x1,5 Thread Size 2 M12x1,5 reinforced version replacement in pairs recommended			
<b>References</b> TESLA 1044396-00-C TESLA 1044396-00-D TESLA 1188396-00-B			
<b>Application info</b> TESLA Model 3 (01/17--) TESLA Model Y (03/19--)			
Stabilizer link		70-16 060 0010/HD	MSL1147HD
<b>Notes</b>  Carbon Neutral Coupling Rod Rear Axle Left  Length [mm] 144 Paired article number 70-16 060 0011/HD   MSL1148HD Required quantity 1 Thread Size 1 M10x1,25 Thread Size 2 M10x1,25 reinforced version replacement in pairs recommended			
<b>References</b> TESLA 1044491-00-E TESLA 1044491-00-F TESLA 1288491-00-A			
<b>Application info</b> TESLA Model 3 (01/17--) TESLA Model S (09/12--) TESLA Model X (09/13--) TESLA Model Y (03/19--)			

## Stabilizer link

70-16 060 0011/HD

MSL1148HD

## Notes

Carbon Neutral  
Coupling Rod  
Rear Axle Right

Length [mm] 144

Paired article number 70-16 060 0010/HD | MSL1147HD

Required quantity 1

Thread Size 1 M10X1,25

Thread Size 2 M10X1,25

reinforced version

replacement in pairs recommended



## References

TESLA 1044496-00-E

TESLA 1044496-00-F

TESLA 1288496-00-A

## Application info

TESLA Model 3 (01/17--)

TESLA Model S (09/12--)

TESLA Model X (09/13--)

TESLA Model Y (03/19--)

## Stabilizer link

716 060 0000

MSL0541

## Notes

Coupling Rod  
Rear Axle Left  
Rear Axle Right

Inner Diameter 1 [mm] 10

Length [mm] 102

Required quantity 2

Thread Size 1 M10x1,5

replacement in pairs recommended



## References

DAIMLER MNA3505AD

DAIMLER MNA3505AE

Ford 1 039 511

Ford 1 054 209

Ford 93BB-5K566-AG

Ford 93BB-5K566-AH

Jaguar MNA3505AA

Jaguar MNA3505AB

Jaguar MNA3505AC

Jaguar MNA3505AD

Jaguar MNA3505AE



**Application info**

DAIMLER XJ (X30) (10/94-06/03)  
 Ford Mondeo I, II (01/93-09/00)  
 Jaguar XJ (X308) (09/96-06/03)

Ford Cougar (08/98-12/01)  
 Jaguar XJ (X300) (09/94-12/99)  
 Jaguar XK 8 (QDV, QEV) (03/96-12/06)

**Stabilizer link**

716 060 0007/HD

MSL0545HD

**Notes**

Carbon Neutral  
 Coupling Rod  
 Front Axle Left  
 Front Axle Right  
 with spanner attachment

Length [mm] 250  
 Required quantity 2  
 Thread Size 1 M10x1,5  
 Thread Size 2 M10x1,5  
 reinforced version  
 replacement in pairs recommended



**References**

Ford 1 117 698  
 Ford 1 219 697  
 Ford 1S71-38438-BA  
 Ford (Chanagan) 1S71-3B438-BA  
 Jaguar C2S3248  
 Jaguar C2S39552

Ford 1 127 646  
 Ford 1S71-38438-AB  
 Ford 1S71-3B438-BA  
 Jaguar C2S26883  
 Jaguar C2S38552

**Application info**

Ford Mondeo III (10/00-09/07)

Jaguar X-Type (03/01-12/09)

**Stabilizer link**

716 060 0008/HD

MSL0546HD

**Notes**

Carbon Neutral  
 Coupling Rod  
 Rear Axle Left  
 Rear Axle Right  
 with spanner attachment

Length [mm] 255  
 Required quantity 2  
 Thread Size 1 M10x1,5  
 Thread Size 2 M10x1,5  
 reinforced version  
 replacement in pairs recommended



**References**

Ford 1 117 800

Ford 1S71-5C486-AC

Ford 1 127 648

Ford 1S71-5C486-AD

**Application info**

Ford Mondeo III (10/00-09/07)

**Stabilizer link**

716 060 0010

MSL0577

**Notes**

Coupling Rod  
Rear Axle Left  
Rear Axle Right

Length [mm]

110

Required quantity

2

Thread Size 1

M10x1,5

replacement in pairs recommended

**References**

Ford 1 500 682

Ford 8M51-5E494-AA

Volvo 30760236

Volvo 30760238

Volvo 31406909

Volvo 31406911

Ford 1 719 542

Ford 8M51-5E494-AB

Volvo 30760237

Volvo 31329967

Volvo 31406910

**Application info**

Ford C-Max I (02/07-09/10)

Ford Focus II (10/03--)





Volvo C30 (09/06-12/13)

Volvo V40 II (03/12--)

Ford C-Max II (04/10--)

Ford Focus III (07/10--)

Volvo S40 II / V50 (12/03-12/12)

Stabilizer link		716 060 0013/HD	MSL0550HD
<b>Notes</b>  Carbon Neutral Coupling Rod Rear Axle Left Rear Axle Right with spanner attachment  Length [mm] 110 Required quantity 2 Thread Size 1 M10x1,5 Thread Size 2 M10x1,5 reinforced version replacement in pairs recommended		 	
<b>References</b> Ford 1 117 801 Ford 1 127 649 Ford 1 130 452 Ford 1S71-5C486-BC Ford 1S71-5C486-BE Ford 1S81-5C486-BE			
<b>Application info</b> Ford Mondeo III (10/00-09/07)			
Stabilizer link		716 060 0013	MSL0550
<b>Notes</b>  Coupling Rod Rear Axle Left Rear Axle Right  Length [mm] 110 Required quantity 2 Thread Size 1 M10x1,5 Thread Size 2 M10x1,5 replacement in pairs recommended		 	
<b>References</b> Ford 1 117 801 Ford 1 130 452 Ford 1S71-5C486-BC Ford 1S71-5C486-BE Ford 1S81-5C486-BE			
<b>Application info</b> Ford Mondeo III (10/00-09/07)			

## Stabilizer link

716 060 0014/HD

MSL0551HD

## Notes

Carbon Neutral  
Coupling Rod  
Front Axle Left  
Front Axle Right

Length [mm]

298

Required quantity

2

Thread Size 1

M10x1,5

Thread Size 2

M10x1,5

reinforced version

replacement in pairs recommended



## References

Ford 1 223 792

Ford 1 230 909

Ford 1 686 594

Ford 1 762 149

Ford 1 851 900

Ford 3M51-3B438-AA

Ford 3M51-3B438-AB

Ford 3M51-3B438-AC

Ford AV61-3B438-AA

Ford AV61-3B438-BA

Ford (Chanagan) 3M51-3B438-AB

Mazda BP4K-34 170B

Mazda BP4K-34-170C

Mazda BP4K-34-170D

Renault 546180001R

Volvo 31340273

Volvo 8623576

## Application info

Ford C-Max I (02/07-09/10)

Ford C-Max II (04/10--)

Ford Focus II (10/03--)

Ford Focus III (07/10--)

Ford Kuga I (02/08-11/12)

Ford Kuga II (05/12--)

Ford Tourneo '13 (09/13--)

Ford Transit '13 (02/13--)

Mazda 3 (BK) (09/99-12/09)

Mazda 5 (CR) (02/05-12/10)

Mazda 5 (CW) (06/10--)

Renault Laguna III / Coupe / Grandtour (10/07-12/15)

Volvo C30 (09/06-12/13)

Volvo C70 II (03/06-12/13)

Volvo S40 II / V50 (12/03-12/12)

Volvo V40 II (03/12--)

**Stabilizer link** **716 060 0015** **MSL0552**

**Notes**

Coupling Rod  
Rear Axle Left  
Rear Axle Right

Length [mm] 74  
Required quantity 2  
Thread Size 1 M10x1,5  
Thread Size 2 M10x1,5  
replacement in pairs recommended



**References**

- |                    |                    |
|--------------------|--------------------|
| Ford 1 223 923     | Ford 1 231 452     |
| Ford 1 253 969     | Ford 1 304 120     |
| Ford 1 310 333     | Ford 1 335 548     |
| Ford 1 469 208     | Ford 1 734 686     |
| Ford 3M51-5C486-BC | Ford 3M51-5C486-BD |
| Ford 3M51-5C486-BE | Ford 3M51-5C486-BF |
| Mazda BP4K-28 170C | Mazda BP4K-28 170E |
| Mazda BP4K-28 170F | Mazda BP4K-28 170G |
| Mazda BP4K-28-170D | Mazda BP4K-28-170H |
| Volvo 30714466     | Volvo 31212548     |
| Volvo 31329966     | Volvo 32283879     |

**Application info**

- |                            |                                  |
|----------------------------|----------------------------------|
| Ford C-Max I (02/07-09/10) | Ford Focus II (10/03--)          |
| Mazda 3 (BK) (09/99-12/09) | Mazda 3 (BL) (12/08-12/14)       |
| Mazda 5 (CR) (02/05-12/10) | Volvo S40 II / V50 (12/03-12/12) |

**Stabilizer link** **716 060 0016/HD** **MSL0553HD**

**Notes**

Carbon Neutral  
Coupling Rod  
Front Axle Left  
Front Axle Right  
with spanner attachment

Length [mm] 290  
Required quantity 2  
Thread Size 1 M12X1,5  
Thread Size 2 M12X1,5  
reinforced version  
replacement in pairs recommended



**References**

Ford 1 763 714

Ford 3C11-3B438-AC

Ford BK21-3B438-AA

Ford USA 2 033 148

Ford 2 033 148

Ford 4 519 467

Ford BK21-3B438-AB

Ford USA BK21-3B438-AB

**Application info**

Ford Tourneo '12 (04/12--)

Ford Transit '06 (04/06-12/14)

Ford Transit Custom '12 (04/12--)

Ford Transit '00 (01/00-05/06)

Ford Transit '14 (08/13--)

**Stabilizer link**

716 060 0017/HD

MSL0554HD

**Notes**

Carbon Neutral  
Coupling Rod  
Front Axle Left  
Front Axle Right  
with spanner attachment

Length [mm]

284

Required quantity

2

Thread Size 1

M10x1,5

Thread Size 2

M10x1,5

reinforced version

replacement in pairs recommended

**References**

Ford 1 146 150

Ford 1 761 200

Ford 2S61-3B438-AD

Ford 5 152 208

Mazda DD32-34-170

Ford 1 469 212

Ford 2S61-3B438-AC

Ford 2S61-3B438-AE

Ford 7L84-5K483-AC

**Application info**

Ford Fiesta V / Fusion (11/01-12/14)

Mazda 2 (DY) (02/03-06/07)

Ford Maverick II (02/01--)

**Stabilizer link****716 060 0018/HD****MSL0555HD****Notes**

Carbon Neutral  
Coupling Rod  
Front Axle Left  
Front Axle Right  
with spanner attachment

Length [mm] 243  
Required quantity 2  
Thread Size 1 M10x1,5  
Thread Size 2 M10x1,5  
reinforced version  
replacement in pairs recommended

**References**

Ford 1 332 453

Ford 2T14-3B438-BB

Ford 2T14-3B438-BA

Ford 4 367 012

**Application info**

Ford Tourneo '02 (06/02-12/13)

Ford Transit '02 (06/02--)

**Stabilizer link****716 060 0022/HD****MSL0559HD****Notes**

Carbon Neutral  
Coupling Rod  
Front Axle Left  
Front Axle Right  
with spanner attachment

Length [mm] 300  
Required quantity 2  
Thread Size 1 M10x1,5  
Thread Size 2 M10x1,5  
reinforced version  
replacement in pairs recommended

**References**

Ford 1 377 849

Ford (Chanagan) 30648461

Volvo 30648461

Volvo (Changan) 30648461

Ford 6G9N-3B438-BA

Ford (Chanagan) 6G9N-3B438-BA

Volvo 31658608

**Application info**

Ford Galaxy II (05/06-06/15)  
 Ford S-Max I (05/06-12/14)  
 Volvo S80 II (03/06-12/16)  
 Volvo XC60 I (05/08-12/17)

Ford Mondeo IV (03/07-01/15)  
 Volvo S60 II / V60 (04/10--)  
 Volvo V70 III (04/07--)  
 Volvo XC70 II (04/07-12/16)

**Stabilizer link**

716 060 0023/HD

MSL0560HD

**Notes**

Carbon Neutral  
 Coupling Rod  
 Rear Axle Left  
 Rear Axle Right  
 with spanner attachment

Length [mm] 133  
 Required quantity 2  
 Thread Size 1 M12X1,5  
 Thread Size 2 M12X1,5  
 reinforced version  
 replacement in pairs recommended



**References**

Ford 1 332 463  
 Ford 2T14-5C486-AG  
 Ford W12T14-5C486-AD

Ford 2T14-5C486-AE  
 Ford 4 436 609

**Application info**

Ford Tourneo '02 (06/02-12/13)

Ford Transit '02 (06/02--)

**Stabilizer link**

716 060 0028/HD

MSL0565HD

**Notes**

Carbon Neutral  
 Coupling Rod  
 Rear Axle Left  
 Rear Axle Right

Length [mm] 76  
 Required quantity 2  
 Thread Size 1 M12x1,25  
 Thread Size 2 M10x1,5  
 reinforced version  
 replacement in pairs recommended





**References**

Ford 1 691 815

Ford 1 714 891

Ford 1 814 315

Ford BV61-5C486-AAA

Ford BV61-5C486-BAB

Volvo 31317271

Volvo 31429024

Ford 1 701 466

Ford 1 767 896

Ford 1 856 667

Ford BV61-5C486-BAA

Ford BV615-C486B-AC

Volvo 31387811

**Application info**

Ford C-Max II (04/10--)

Volvo V40 II (03/12--)

Ford Focus III (07/10--)

**Stabilizer link****716 060 0029/HD****MSL0941HD****Notes**Carbon Neutral  
Coupling Rod  
Front Axle Left  
Front Axle Right

Length [mm]

299

Required quantity

2

Thread Size 1

M12X1,5

Thread Size 2

M12X1,5

replacement in pairs recommended

**References**

Ford 2 214 255

Ford DG9C-3B438-ANC

Ford USA 5182780

Ford 5 182 780

Ford JB3C-3052-AA

Ford USA DG9C3B438ANC

**Application info**



Ford Galaxy III (01/15--)

Ford Ranger III (04/11--)

Ford USA Edge (01/14--)

Ford Mondeo V (09/12--)

Ford S-Max II (01/15--)

Stabilizer link		716 060 0031	MSL0885
<b>Notes</b>  Coupling Rod Front Axle Left Front Axle Right with spanner attachment  Length [mm] 250 Required quantity 2 Thread Size 1 M10x1,5 Thread Size 2 M10x1,5 replacement in pairs recommended			
<b>References</b> Ford 1 117 698 Ford 1 127 646 Ford 1 219 697 Ford 1S71-38438-AB Ford 1S71-38438-BA Ford 1S71-3B438-BA Ford (Chanagan) 1S71-3B438-BA Jaguar C2S26883 Jaguar C2S3248 Jaguar C2S38552 Jaguar C2S39552			
<b>Application info</b> Ford Mondeo III (10/00-09/07) Jaguar X-Type (03/01-12/09)			
Stabilizer link		716 060 0032	MSL0886
<b>Notes</b>  Coupling Rod Front Axle Left Front Axle Right with spanner attachment  Length [mm] 298 Required quantity 2 Thread Size 1 M10x1,5 Thread Size 2 M10x1,5 replacement in pairs recommended			

**References**

Ford 1 223 792	Ford 1 230 909
Ford 1 686 594	Ford 1 762 149
Ford 1 851 900	Ford 3M51-3B438-AA
Ford 3M51-3B438-AB	Ford 3M51-3B438-AC
Ford AV61-3B438-AA	Ford AV61-3B438-BA
Ford (Chanagan) 3M51-3B438-AB	Mazda BP4K-34 170B
Mazda BP4K-34-170C	Mazda BP4K-34-170D
Renault 546180001R	Renault 546180010R
Renault 546183913R	Volvo 31340273
Volvo 8623576	

**Application info**

Ford C-Max I (02/07-09/10)	Ford C-Max II (04/10--)
Ford Focus II (10/03--)	Ford Focus III (07/10--)
Ford Kuga I (02/08-11/12)	Ford Kuga II (05/12--)
Ford Tourneo '13 (09/13--)	Ford Transit '13 (02/13--)
Mazda 3 (BK) (09/99-12/09)	Mazda 5 (CR) (02/05-12/10)
Mazda 5 (CW) (06/10--)	Renault Laguna III / Coupe / Grandtour (10/07-12/15)
Renault Latitude (07/10--)	Volvo C30 (09/06-12/13)
Volvo C70 II (03/06-12/13)	Volvo S40 II / V50 (12/03-12/12)
Volvo V40 II (03/12--)	

**Stabilizer link****716 060 0033****MSL0887****Notes**

Coupling Rod  
Front Axle Left  
Front Axle Right  
with spanner attachment

Length [mm] 290  
Required quantity 2  
Thread Size 1 M12X1,5  
Thread Size 2 M12X1,5  
replacement in pairs recommended

**References**

Ford 1 763 714	Ford 2 033 148
Ford 3C11-3B438-AC	Ford 4 519 467
Ford BK21-3B438-AA	Ford BK21-3B438-AB
Ford USA 2 033 148	Ford USA BK21-3B438-AB

**Application info**

Ford Tourneo '12 (04/12--)  
 Ford Transit '06 (04/06-12/14)  
 Ford Transit Custom '12 (04/12--)

Ford Transit '00 (01/00-05/06)  
 Ford Transit '14 (08/13--)

**Stabilizer link**

716 060 0035

MSL0889

**Notes**

Coupling Rod  
 Rear Axle Left  
 Rear Axle Right  
 with spanner attachment

Length [mm] 255  
 Required quantity 2  
 Thread Size 1 M10x1,5  
 Thread Size 2 M10x1,5  
 replacement in pairs recommended



**References**

Ford 1 117 800  
 Ford 1S71-5C486-AC

Ford 1 127 648  
 Ford 1S71-5C486-AD

**Application info**

Ford Mondeo III (10/00-09/07)

**Stabilizer link**

716 060 0036

MSL0890

**Notes**

Coupling Rod  
 Front Axle Left  
 Front Axle Right  
 with spanner attachment

Length [mm] 284  
 Required quantity 2  
 Thread Size 1 M10x1,5  
 Thread Size 2 M10x1,5  
 replacement in pairs recommended



**References**

Ford 1 146 150  
 Ford 1 761 200  
 Ford 2S61-3B438-AD  
 Ford 5 152 208  
 Mazda DD32-34-170

Ford 1 469 212  
 Ford 2S61-3B438-AC  
 Ford 2S61-3B438-AE  
 Ford 7L84-5K483-AC

**Application info**

Ford Fiesta V / Fusion (11/01-12/14)  
Mazda 2 (DY) (02/03-06/07)

Ford Maverick II (02/01--)

**Stabilizer link****716 060 0037****MSL0891****Notes**

Coupling Rod  
Front Axle Left  
Front Axle Right  
with spanner attachment

Length [mm] 243  
Required quantity 2  
Thread Size 1 M10x1,5  
Thread Size 2 M10x1,5  
replacement in pairs recommended

**References**

Ford 1 332 453  
Ford 2T14-3B438-BB

Ford 2T14-3B438-BA  
Ford 4 367 012

**Application info**

Ford Tourneo '02 (06/02-12/13)

Ford Transit '02 (06/02--)

**Stabilizer link****716 060 0038****MSL0892****Notes**

Coupling Rod  
Front Axle Left  
Front Axle Right  
with spanner attachment

Length [mm] 300  
Required quantity 2  
Thread Size 1 M10x1,5  
Thread Size 2 M10x1,5  
replacement in pairs recommended

**References**

Ford 1 377 849  
Ford (Chanagan) 30648461  
Volvo 30648461  
Volvo (Changan) 30648461

Ford 6G9N-3B438-BA  
Ford (Chanagan) 6G9N-3B438-BA  
Volvo 31658608

**Application info**

Ford Galaxy II (05/06-06/15)  
 Ford S-Max I (05/06-12/14)  
 Volvo S80 II (03/06-12/16)  
 Volvo XC60 I (05/08-12/17)

Ford Mondeo IV (03/07-01/15)  
 Volvo S60 II / V60 (04/10--)  
 Volvo V70 III (04/07--)  
 Volvo XC70 II (04/07-12/16)

**Stabilizer link****716 060 0039****MSL0893****Notes**

Coupling Rod  
 Rear Axle Left  
 Rear Axle Right  
 with spanner attachment

Length [mm] 133  
 Required quantity 2  
 Thread Size 1 M12X1,5  
 Thread Size 2 M12X1,5  
 replacement in pairs recommended

**References**

Ford 1 332 463  
 Ford 2T14-5C486-AG  
 Ford W12T14-5C486-AD

Ford 2T14-5C486-AE  
 Ford 4 436 609

**Application info**

Ford Tourneo '02 (06/02-12/13)

Ford Transit '02 (06/02--)

**Stabilizer link****716 060 0040****MSL0894****Notes**

Coupling Rod  
 Front Axle Left  
 Front Axle Right  
 with spanner attachment

Length [mm] 238  
 Required quantity 2  
 Thread Size 1 M10x1,5  
 Thread Size 2 M10x1,5  
 replacement in pairs recommended



**References**

Ford 1 004 018	Ford 1 061 631
Ford 1 067 818	Ford 1 071 336
Ford 1 107 068	Ford 1 107 069
Ford 1 111 769	Ford 1 130 273
Ford 1 135 077	Ford 1 209 035
Ford 1 471 446	Ford 1 661 237
Ford 1S61-3B438-AA	Ford 5 106 995
Ford 6 186 082	Ford 6 188 004
Ford 6 198 621	Ford 89FB-3B438-A1E
Ford 89FB-3B438-AB	Ford 89FB-3B438-AC
Ford 89FB3-B438A-1D	Ford 89FB3-B438A-1F
Ford 96FB-3B438-AB	Ford 98AG-3B438-AA
Ford 98AG-3B438-AB	Ford 98AG-3B438-AC
Ford 98AG-3B438-AD	Ford YS41 3B438-BA
Ford YS41-3B438-AA	Ford YS41-3B438-AB
Ford YS41-3B438-BB	Ford YS71-3B438-AB
Ford (Chanagan) 1S61-3B438-AA	Mazda 1E00-34-170
Mazda 1E01-34-170A	

**Application info**

Ford Escort V, VI, VII / Orion III (01/90-10/02)	Ford Fiesta III (01/89-01/97)
Ford Fiesta IV / Puma (08/95--)	Ford Focus I (08/98-11/09)
Ford KA I (09/96-11/08)	Mazda 121 (JASM, JBSM) (01/96-04/03)

**Stabilizer link****716 060 0042****MSL0896****Notes**

Coupling Rod  
 Front Axle Left  
 Front Axle Right  
 with spanner attachment

Length [mm] 250  
 Required quantity 2  
 Thread Size 1 M10x1,5  
 Thread Size 2 M10x1,5  
 replacement in pairs recommended



**References**

Ford 1 513 343

Ford 1 790 310

Ford 2 069 658

Ford 8V51-3B438-AB

Ford 8V51-3B438-BB

Ford 8V51-3B438-BD

Mazda D651-34-170

Ford 1 745 924

Ford 1 905 043

Ford 2 513 086

Ford 8V51-3B438-BA

Ford 8V51-3B438-BC

Ford ME8V5J-3B438-BD

Mazda D651-34-170A

**Application info**

Ford B-MAX (08/12--)

Ford Fiesta VI (06/08--)

Ford KA III (08/14--)

Ford Tourneo '14 (02/14--)

Mazda 2 (DE) (07/07-06/15)

Ford Ecosport (09/11--)

Ford Fiesta VII (05/17--)

Ford Puma (09/19--)

Ford Transit Courier '14 (02/14--)

**Stabilizer link****716 060 0044/HD****MSL1024HD****Notes**Carbon Neutral  
Coupling Rod  
Rear Axle Left  
Rear Axle Right

Length [mm]

120

Required quantity

2

Thread Size 1

M12X1,5

Thread Size 2

M12X1,5

reinforced version

replacement in pairs recommended

**References**

Ford 2 463 429

Ford 5 282 207

Ford USA DG9C-5C486-AXC

Ford USA F2GC-5C486-AXB

Ford 5 182 818

Ford 5 295 981

Ford USA F2GC-5C486-AXA

Ford USA F2GC-5C486-AXC

**Application info**

Ford Galaxy III (01/15--)





Ford S-Max II (01/15--)



Ford USA Mustang (02/14--)

Ford Mondeo V (09/12--)

Ford USA Edge (01/14--)



Stabilizer link		716 060 0045/HD	MSL1010HD
<b>Notes</b>  Carbon Neutral Coupling Rod Lower Rear Axle Left Rear Axle Right  Length [mm] 102 Required quantity 2 Thread Size 1 M10X1,5 Thread Size 2 M10X1,5 reinforced version replacement in pairs recommended		 	
<b>References</b> Ford 2 099 504 Ford 2 173 832 Ford JX615-C486-AKB Ford JX615-C486-AKC			
<b>Application info</b> Ford Focus IV (01/18--)			
Stabilizer link		716 060 0047/HD	MSL1173HD
<b>Notes</b>  Carbon Neutral Coupling Rod Rear Axle Left Rear Axle Right  Length [mm] 238 Required quantity 2 Thread Size 1 M12x1,5 Thread Size 2 M8x1,25 reinforced version replacement in pairs recommended		 	
<b>References</b> Ford 2 200 512 Ford 2 346 598 Ford JX61-5C486-BEA Ford JX61-5C486-BEB			
<b>Application info</b> Ford Focus IV (01/18--)			

Stabilizer link		716 060 0048	MSL1165
<p><b>Notes</b></p> <p>Coupling Rod Rear Axle Left Rear Axle Right</p> <p>Length [mm] 347 Required quantity 2 Thread Size 1 M12X1,75 replacement in pairs recommended</p>			
<p><b>References</b></p> <p>Ford 1 810 747 Ford 1 824 008 Ford 1 849 811 Ford BK31-5C486-AA Ford BK31-5C486-AB Ford BK31-5C486-AC</p>			
<p><b>Application info</b></p> <p>Ford Transit '14 (08/13--)</p>			
Stabilizer link		716 060 0049	MSL1162
<p><b>Notes</b></p> <p>Coupling Rod Rear Axle Left Rear Axle Right Steel for vehicles with standard suspension</p> <p>Diameter [mm] 12.1 Length [mm] 172 Pipe Diameter [mm] 14 Required quantity 2 replacement in pairs recommended</p>			
<p><b>References</b></p> <p>Ford 2 009 794 Ford 2 010 922 Ford 2 096 027 Ford 2 185 084 Ford GK21-5C486-BB Ford GK21-5C486-BC Ford GK21-5C486-BD Ford GK21-5C486-BE</p>			
<p><b>Application info</b></p> <p>Ford Tourneo '12 (04/12--)</p> <p>Ford Transit Custom '12 (04/12--)</p>			

**Stabilizer link**

716 060 0050/HD

MSL1158HD

**Notes**

Carbon Neutral  
Coupling Rod  
Front Axle Left  
Front Axle Right

Length [mm]

255

Pipe Diameter [mm]

10

Required quantity

2

Thread Size 1

M12x1,5

Thread Size 2

M12x1,5

reinforced version

replacement in pairs recommended

**References**

Ford 1 732 869

Ford AB31-3052-AA

Ford USA 1732869

Ford USA AB31-3052-AA

Ford 2 113 317

Ford EB3C-3052-AA

Ford USA 2113317

Ford USA EB3C-3052-AA

**Application info**

Ford Ranger III (04/11--)

**Stabilizer link**

716 060 0051/HD

MSL1097HD

**Notes**

Carbon Neutral  
Coupling Rod  
Front Axle Left  
Front Axle Right

Length [mm]

225

Required quantity

2

Thread Size 1

M12 X 1,25

Thread Size 2

M12 X 1,25

replacement in pairs recommended

**References**

Ford USA 2031926



Ford USA FR3C5K483AA



Ford USA 5282208

Ford USA FR3C5K483AB

**Application info**

Ford USA Mustang (02/14--)

Stabilizer link		716 060 0054/HD	MSL1015HD
<b>Notes</b>  Carbon Neutral Coupling Rod Front Axle Left Front Axle Right  Length [mm] 298 Required quantity 2 Thread Size 1 M12X1,5 Thread Size 2 M12X1,5 replacement in pairs recommended			
<b>References</b> Ford 2 197 192 Ford 2 216 271 Ford 2 286 405 Ford JX61-3B438-AEB Ford JX61-3B438-AEC Ford JX61-3B438-AKC			
<b>Application info</b> Ford Focus IV (01/18--)			
Stabilizer link		716 060 0055/HD	MSL1087HD
<b>Notes</b>  Carbon Neutral Coupling Rod Front Axle Left  Length [mm] 225 Paired article number 716 060 0056/HD   MSL1088HD Required quantity 1 Thread Size 1 M12x1,75 Thread Size 2 M12x1,75 reinforced version replacement in pairs recommended			
<b>References</b> Ford 1 732 874 Ford 2 113 322 Ford AB31-3053-CA Ford EB3C-3053-BA			
<b>Application info</b> Ford Ranger III (04/11--)			

Stabilizer link		716 060 0056/HD	MSL1088HD
<p><b>Notes</b></p> <p>Carbon Neutral Coupling Rod Front Axle Right</p> <p>Length [mm] 225</p> <p>Paired article number 716 060 0055/HD   MSL1087HD</p> <p>Required quantity 1</p> <p>Thread Size 1 M12x1,75</p> <p>Thread Size 2 M12x1,75</p> <p>reinforced version</p> <p>replacement in pairs recommended</p>		 <p>A black metal stabilizer link with threaded ends and a central coupling rod. A yellow circular badge in the top right corner reads 'MEYLE HD REINFORCED'.</p>	
<p><b>References</b></p> <p>Ford 1 732 872 Ford 2 113 320</p>			
<p><b>Application info</b></p> <p>Ford Ranger III (04/11--)</p>			
Stabilizer link		716 060 0090/HD	MSL0561HD
<p><b>Notes</b></p> <p>Carbon Neutral Coupling Rod Front Axle Left Front Axle Right with spanner attachment</p> <p>Length [mm] 238</p> <p>Required quantity 2</p> <p>Thread Size 1 M10x1,5</p> <p>Thread Size 2 M10x1,5</p> <p>reinforced version</p> <p>replacement in pairs recommended</p>		 <p>A black metal stabilizer link with threaded ends and a central coupling rod. A yellow circular badge in the top right corner reads 'MEYLE HD REINFORCED'.</p>	

**References**

Ford 1 004 018	Ford 1 061 631
Ford 1 067 818	Ford 1 071 336
Ford 1 106 269	Ford 1 107 068
Ford 1 107 069	Ford 1 111 769
Ford 1 130 273	Ford 1 135 077
Ford 1 209 035	Ford 1 471 446
Ford 1 661 237	Ford 1S61-3B438-AA
Ford 5 106 995	Ford 6 186 082
Ford 6 188 004	Ford 6 198 621
Ford 6 960 036	Ford 89FB-3B438-A1E
Ford 89FB-3B438-AB	Ford 89FB-3B438-AC
Ford 89FB3-B438A-1D	Ford 89FB3-B438A-1F
Ford 93BB-3B438-CA	Ford 96FB-3B438-AB
Ford 98AG-3B438-AA	Ford 98AG-3B438-AB
Ford 98AG-3B438-AC	Ford 98AG-3B438-AD
Ford YS41 3B438-BA	Ford YS41-3B438-AA
Ford YS41-3B438-AB	Ford YS41-3B438-BB
Ford YS71 3B438-AA	Ford YS71-3B438-AB
Ford (Chanagan) 1S61-3B438-AA	Mazda 1E00-34-170
Mazda 1E01-34-170A	

**Application info**

Ford Cougar (08/98-12/01)	Ford Escort V, VI, VII / Orion III (01/90-10/02)
Ford Fiesta III (01/89-01/97)	Ford Fiesta IV / Puma (08/95--)
Ford Focus I (08/98-11/09)	Ford KA I (09/96-11/08)
Ford Mondeo I, II (01/93-09/00)	Mazda 121 (JASM, JBSM) (01/96-04/03)

**Stabilizer link****716 060 0091/HD****MSL0594HD****Notes**

Carbon Neutral  
Coupling Rod  
Rear Axle Left  
Rear Axle Right  
Length [mm] 179  
Required quantity 2  
Thread Size 1 M10x1,5  
Thread Size 2 M8x1,25

reinforced version

replacement in pairs recommended



**References**

Ford 1 377 349	Ford 1 377 398
Ford 1 377 416	Ford 1 425 853
Ford 1 502 681	Ford 1 783 320
Ford 6G915-C486X-AA	Ford 6G915-C486X-AB
Ford 8V41-5C486-AA	Ford CV615-C486A-AB
Volvo 30736875	Volvo 30760678
Volvo 31429561	Volvo 31451817
Volvo 31476579	

**Application info**

Ford Galaxy II (05/06-06/15)	Ford Kuga I (02/08-11/12)
Ford Kuga II (05/12--)	Ford Mondeo IV (03/07-01/15)
Ford S-Max I (05/06-12/14)	Volvo S60 II / V60 (04/10--)
Volvo S80 II (03/06-12/16)	Volvo V70 III (04/07--)
Volvo XC60 I (05/08-12/17)	Volvo XC70 II (04/07-12/16)

**Stabilizer link**

716 060 0092/HD

MSL1156HD

**Notes**

Carbon Neutral  
Coupling Rod  
Front Axle Left  
Front Axle Right  
Steel



Length [mm] 318  
Pipe Diameter [mm] 10  
Required quantity 2  
Thread Size 1 M12x1,5  
Thread Size 2 M12x1,5  
reinforced version  
replacement in pairs recommended

**References**

Ford 2 451 509	Ford LX613B438AEA
----------------	-------------------

**Application info**

Ford Kuga III (07/19--)

Stabilizer link		716 060 0093/HD	MSL1159HD
<p><b>Notes</b></p> <p>Carbon Neutral Coupling Rod Rear Axle Left Rear Axle Right Steel</p> <p>Length [mm] 120 Pipe Diameter [mm] 10 Required quantity 2 Thread Size 1 M12x1,5 Thread Size 2 M12x1,5 reinforced version replacement in pairs recommended</p>			
<p><b>References</b></p> <p>Ford 2 416 280</p>		<p>Ford LX61-5C486-ANA</p>	
<p><b>Application info</b></p> <p>Ford Kuga III (07/19--)</p>			
Suspension Kit		37-16 610 0002	MCR0079
<p><b>Notes</b></p> <p>Front Axle Left Front Axle Right for control arm with ball joint with rubber mount</p> <p>Required quantity 2 replacement in pairs recommended</p>			



**References**

Hyundai 54500-2S000  
 Hyundai 54500-2Y001  
 Hyundai 54500-3W102  
 Hyundai 54501-2Y000  
 Hyundai 54501-2Y002  
 Hyundai 54530-3S000  
 Hyundai 54584-2S000  
 Kia 54500 2Y001  
 Kia 54501 2Y000  
 Kia 54501 2Y002  
 Kia 54551 2S000

Hyundai 54500-2Y000  
 Hyundai 54500-2Y002  
 Hyundai 54501-2S000  
 Hyundai 54501-2Y001  
 Hyundai 54501-3W102  
 Hyundai 54551-2S000  
 Kia 54500 2Y000  
 Kia 54500 2Y002  
 Kia 54501 2Y001  
 Kia 54530 3S000  
 Kia 54584-2S000

**Application info**

Hyundai Tucson I (06/04--)  
 Kia Sportage III (09/09--)

Hyundai ix35 (08/09--)

**Suspension Kit****40-16 610 0000/HD****MCR0117HD****Notes**

Carbon Neutral  
 Front Axle Left  
 Front Axle Right  
 for control arm  
 with ball joint  
 with rubber mount

Replace in pairs only  
 Required quantity  
 reinforced version

2

**References**

Citroën 3520.H5  
 Citroën 3523.75  
 Citroën 96 110 483  
 Peugeot 3520.H5  
 Peugeot 3523.75

Citroën 3521.E5  
 Citroën 3640.43  
 Peugeot 1215145  
 Peugeot 3521.E5  
 Peugeot 3640.38

**Application info**

Citroën Berlingo I (07/96-12/11)  
 Citroën ZX (03/91-07/99)

Citroën Xsara (04/97-03/10)  
 Peugeot Partner I (05/96--)

**Suspension Kit**

44-14 610 0007

MCR0118

**Notes**

Front Axle Left  
 Front Axle Right  
 for control arm  
 with ball joint  
 with rubber mount

Required quantity  
 replacement in pairs recommended



**References**

Chrysler 04656730AH  
 Chrysler 04656731AH  
 Chrysler 4656730AD  
 Chrysler 4656730AL  
 Chrysler 4656731AD  
 Chrysler 4656731AL  
 Chrysler 5272236  
 Chrysler 5272236AC  
 Chrysler 5272236AH  
 Chrysler 5272236AK  
 Chrysler 5272236AM  
 Chrysler 5272237AB  
 Chrysler 5272237AF  
 Chrysler 5272237AJ  
 Chrysler 5272237AL  
 Dodge 5272236AC  
 Dodge 5272236AH  
 Dodge 5272236AK  
 Dodge 5272236AM  
 Dodge 5272237AF  
 Dodge 5272237AJ  
 Dodge 5272237AL

Chrysler 04656730AN  
 Chrysler 04656731AN  
 Chrysler 4656730AH  
 Chrysler 4656730AN  
 Chrysler 4656731AH  
 Chrysler 4656731AN  
 Chrysler 5272236AB  
 Chrysler 5272236AF  
 Chrysler 5272236AJ  
 Chrysler 5272236AL  
 Chrysler 5272237  
 Chrysler 5272237AC  
 Chrysler 5272237AH  
 Chrysler 5272237AK  
 Chrysler 5272237AM  
 Dodge 5272236AF  
 Dodge 5272236AJ  
 Dodge 5272236AL  
 Dodge 5272237AB  
 Dodge 5272237AH  
 Dodge 5272237AK  
 Dodge 5272237AM

**Application info**

Chrysler Neon II (08/99-12/06)  
 Dodge Neon II (08/99--)

Chrysler PT Cruiser (06/00-12/10)

**Suspension Kit** 44-14 610 0008 MCR0119

**Notes**

Front Axle Left  
 Front Axle Right  
 for control arm  
 with ball joint  
 with rubber mount

Required quantity  
 replacement in pairs recommended

2



**References**

Chrysler 4684120  
 Chrysler 4743095AA  
 Chrysler 4766542AD  
 Chrysler 4766543AD

Chrysler 4743094AA  
 Chrysler 4766542AA  
 Chrysler 4766543AA

**Application info**

Chrysler Voyager IV/ Town Country (09/99-12/08)

**Suspension Kit** 516 610 0000 MCR0131

**Notes**

Front Axle Right  
 for control arm  
 with ball joint  
 with rubber mount

Paired article number  
 Required quantity  
 replacement in pairs recommended

516 610 0001 | MCR0080  
 1



**References**



Volvo 30681488  
 Volvo 31317666

Volvo 31277526

**Application info**

Volvo XC60 I (05/08-12/17)

**Suspension Kit** 516 610 0001 MCR0080

<b>Notes</b>		 
Paired article number	Front Axle Left for control arm with ball joint with rubber mount	
Required quantity	516 610 0000   MCR0131	
replacement in pairs recommended	1	

<b>References</b>	
Volvo 30681487	Volvo 31277525
Volvo 31317665	

<b>Application info</b>	
Volvo XC60 I (05/08-12/17)	

**Suspension Kit** 53-14 610 0026 MCR0059

<b>Notes</b>		 
Required quantity	Front Axle Left Front Axle Right	
replacement in pairs recommended	2	

**References**

- |                               |                               |
|-------------------------------|-------------------------------|
| Ford 1 377 846                | Ford 1 385 593                |
| Ford 1 403 408                | Ford 1 419 814                |
| Ford 1 426 875                | Ford 1 435 745                |
| Ford 1 458 773                | Ford 1 460 693                |
| Ford 1 466 186                | Ford 1 466 188                |
| Ford 1 469 024                | Ford 1 507 181                |
| Ford 1 507 182                | Ford 6G9N-3A052-DG            |
| Ford 6G9N-3A052-DH            | Ford 6G9N-3A053-DG            |
| Ford 6G9N-3A053-DH            | Ford 7G9N-3A052-BA            |
| Ford 7G9N-3A052-BB            | Ford 7G9N-3A053-BA            |
| Ford 7G9N-3A053-BB            | Ford (Chanagan) 7G9N-3A052-BA |
| Ford (Chanagan) 7G9N-3A052-BB | Ford (Chanagan) 7G9N-3A053-BA |
| Ford (Chanagan) 7G9N-3A053-BB | Volvo 30683248                |
| Volvo 30683249                | Volvo 31200563                |
| Volvo 31200775                | Volvo 31200776                |
| Volvo 31202228                | Volvo 31202229                |
| Volvo 31212781                | Volvo 31212782                |
| Volvo 31277343                | Volvo 31277344                |
| Volvo 31277345                | Volvo 31277346                |
| Volvo 31277525                | Volvo 31277526                |
| Volvo 31317661                | Volvo 31317662                |
| Volvo 31317663                | Volvo 31317664                |
| Volvo 31317665                | Volvo 31317666                |
| Volvo 31340127                | Volvo 31340128                |
| Volvo 31429320                | Volvo 31429321                |

**Application info**

- |                              |                              |
|------------------------------|------------------------------|
| Ford Galaxy II (05/06-06/15) | Ford Mondeo IV (03/07-01/15) |
| Ford S-Max I (05/06-12/14)   | Volvo S60 II / V60 (04/10--) |
| Volvo S80 II (03/06-12/16)   | Volvo V70 III (04/07--)      |
| Volvo XC60 I (05/08-12/17)   | Volvo XC70 II (04/07-12/16)  |

**Suspension Kit**

616 610 0001

MCR0120

**Notes**

Front Axle Left  
 Front Axle Right  
 for control arm  
 with ball joint  
 with rubber mount

Required quantity  
 replacement in pairs recommended

2



**References**

GENERAL MOTORS 13140037  
 GENERAL MOTORS 13140039  
 GENERAL MOTORS 24428977  
 GENERAL MOTORS 24449453  
 Opel 03 52 041  
 Opel 03 52 045  
 Opel 03 52 061  
 Opel 03 52 064  
 Opel 3 52 041  
 Opel 3 52 045  
 Opel 3 52 061  
 Opel 3 52 064  
 Vauxhall 03 52 041  
 Vauxhall 03 52 045  
 Vauxhall 03 52 061  
 Vauxhall 03 52 064  
 Vauxhall 3 52 041  
 Vauxhall 3 52 045  
 Vauxhall 3 52 061  
 Vauxhall 3 52 064

GENERAL MOTORS 13140038  
 GENERAL MOTORS 13140040  
 GENERAL MOTORS 24428978  
 GENERAL MOTORS 24449455  
 Opel 03 52 042  
 Opel 03 52 046  
 Opel 03 52 063  
 Opel 03 52 065  
 Opel 3 52 042  
 Opel 3 52 046  
 Opel 3 52 063  
 Opel 3 52 065  
 Vauxhall 03 52 042  
 Vauxhall 03 52 046  
 Vauxhall 03 52 063  
 Vauxhall 03 52 065  
 Vauxhall 3 52 042  
 Vauxhall 3 52 046  
 Vauxhall 3 52 063  
 Vauxhall 3 52 065

**Application info**

Opel Corsa C / Combo / Tigra (09/00--)

Vauxhall Combo Mk II (09/01-02/12)

Vauxhall Corsa Mk II / Tigra / Combo (08/00-02/12)

**Suspension Kit**

616 610 0004

MCR0121

**Notes**

Front Axle Left  
 Front Axle Right  
 for control arm  
 with ball joint  
 with rubber mount

Required quantity  
 replacement in pairs recommended

2



**References**

- |                         |                         |
|-------------------------|-------------------------|
| Chevrolet 24428208      | Chevrolet 24428209      |
| Chevrolet 24454477      | Chevrolet 24454478      |
| Chevrolet 90498735      | Chevrolet 90498736      |
| GENERAL MOTORS 24428208 | GENERAL MOTORS 24428209 |
| GENERAL MOTORS 24454477 | GENERAL MOTORS 24454478 |
| GENERAL MOTORS 90498735 | GENERAL MOTORS 90498736 |
| Opel 03 52 037          | Opel 03 52 038          |
| Opel 3 52 037           | Opel 3 52 038           |
| Opel 53 52 016          | Opel 53 52 017          |
| Opel 53 52 029          | Opel 53 52 030          |
| Vauxhall 03 52 037      | Vauxhall 03 52 038      |
| Vauxhall 3 52 037       | Vauxhall 3 52 038       |
| Vauxhall 53 52 016      | Vauxhall 53 52 017      |
| Vauxhall 53 52 029      | Vauxhall 53 52 030      |

**Application info**

- |                                       |   |
|---------------------------------------|---|
| Chevrolet Zafira (F75) (02/99-12/12)  | Opel Astra G / Astra Classic / Zafira A (02/98-12/09) |
| Opel Astra H / Zafira B (01/04-05/19) | Opel Astra J (12/06--)                                |
| Opel Meriva B (06/10-03/17)           | Vauxhall Astra Mk IV (01/93-08/06)                    |
| Vauxhall Astra Mk V (01/04--)         | Vauxhall Insignia Mk I A (07/08-05/17)                |
| Vauxhall Meriva Mk II B (06/10--)     | Vauxhall Zafira Mk I (11/98-08/05)                    |
| Vauxhall Zafira Mk II (04/05-11/14)   |   |

**Suspension Kit**

616 610 0005

MCR0083

**Notes**

Front Axle Left  
 Front Axle Right  
 for control arm  
 with ball joint  
 with rubber mount  
 2

Required quantity  
 replacement in pairs recommended



**References**

ABARTH 51839039	Alfa Romeo 51783056
Alfa Romeo 51892272	Alfa Romeo 51892273
Alfa Romeo 51895366	Alfa Romeo 51895367
Alfa Romeo 55703627	Alfa Romeo 55703629
Citroën 3520 Y4	Citroën 3520.W3
Citroën 3521.S6	Citroën 3521.V5
Fiat 51783056	Fiat 51783057
Fiat 51839039	Fiat 51839040
Fiat 51874461	Fiat 51874462
Fiat 51892272	Fiat 51892273
Fiat 51895366	Fiat 51895367
Fiat 55703627	Fiat 55703629
GENERAL MOTORS 13426552	GENERAL MOTORS 13426553
GENERAL MOTORS 55703230	GENERAL MOTORS 55703231
Opel 3 52 542	Opel 3 52 543
Opel 53 52 038	Opel 53 52 039
Peugeot 16 109 420 80	Peugeot 16 109 421 80
Peugeot 16 180 674 80	Peugeot 16 180 675 80
Peugeot 3520 Y4	Peugeot 3520.W3
Peugeot 3521.S6	Peugeot 3521.V5
Vauxhall 53 52 038	Vauxhall 53 52 039

**Application info**

ABARTH Grande Punto (12/07-12/12)	ABARTH Punto III (03/12--)
Alfa Romeo Mito (08/08--)	Citroën Nemo (02/08--)
Fiat Fiorino Nuovo (225) (01/07--)	Fiat Grande Punto (06/05--)
Fiat Linea (10/06--)	Fiat Punto Evo (07/08--)
Fiat Punto III (01/12--)	Fiat Qubo (02/08--)
Opel Adam (10/12-02/19)	Opel Corsa D (07/06-08/14)
Peugeot Bipper (02/08--)	Vauxhall Adam (10/12-04/19)
Vauxhall Combo Mk III (07/06--)	Vauxhall Corsa Mk III (07/06-08/14)

**Suspension Kit****714 610 0025/HD****MCR0129HD****Notes**

Carbon Neutral  
Front Axle Left  
Front Axle Right  
Set

Replace in pairs only  
Required quantity  
reinforced version

2





**References**

- |                     |                     |
|---------------------|---------------------|
| Ford 1 927 131      | Ford 1 927 132      |
| Ford 2 180 767      | Ford 2 180 769      |
| Ford 5 232 480      | Ford 5 232 481      |
| Ford 5 303 328      | Ford 5 303 329      |
| Ford FG9C3-A052A-NA | Ford FG9C3-A052A-NB |
| Ford FG9C3-A052A-NC | Ford FG9C3-A053A-NA |
| Ford FG9C3-A053A-NB | Ford FG9C3-A053A-NC |

**Application info**

Ford Mondeo V (09/12--)

**Suspension Kit**

714 619 0003/S

MCR0027

**Notes**

Front Axle Left  
 Front Axle Right  
 Set  
 with accessories

Required quantity  
 replacement in pairs recommended

2



**References**

- |                |                |
|----------------|----------------|
| Ford 5 021 464 | Ford 5 021 465 |
| Ford 6 154 287 | Ford 6 154 288 |
| Ford 6 154 290 | Ford 6 194 368 |
| Ford 6 194 370 |                |

**Application info**

Ford Scorpio I (04/85-12/94) Ford Sierra (08/82-03/93)

**Suspension Kit**

716 610 0001

MCR0122

**Notes**

Front Axle Left  
 Front Axle Right  
 for control arm  
 with ball joint  
 with rubber mount

Required quantity  
 replacement in pairs recommended

2



**References**

The references of this product can be found at [www.meyle.com](http://www.meyle.com)

**Application info**

Ford Fiesta IV / Puma (08/95--)

Mazda 121 (JASM, JBSM) (01/96-04/03)

**Suspension Kit**

716 610 0002

MCR0123

**Notes**

Front Axle Left  
 Front Axle Right  
 for control arm  
 with ball joint  
 with rubber mount

Required quantity  
 replacement in pairs recommended



**References**

Ford 1 332 454

Ford 1 332 455

Ford 1 355 048

Ford 1 355 050

Ford 2T14-3042-BF

Ford 2T14-3042-BH

Ford 2T14-3042-BJ

Ford 2T14-3051-BF

Ford 2T14-3051-BH

Ford 4 366 973

Ford 4 366 974

Ford 4 539 871

Ford 4T16-3042-AA

Ford 4T16-3051-AA

**Application info**

Ford Tourneo '02 (06/02-12/13)

Ford Transit '02 (06/02--)

**Suspension Kit**

716 610 0003

MCR0124

**Notes**

Front Axle Left  
 Front Axle Right  
 for control arm  
 with ball joint  
 with rubber mount

Required quantity  
 replacement in pairs recommended



**References**

- |                   |                   |
|-------------------|-------------------|
| Ford 1 146 130    | Ford 1 146 131    |
| Ford 1 207 447    | Ford 1 207 448    |
| Ford 1 211 757    | Ford 1 212 807    |
| Ford 1 212 808    | Ford 1 214 911    |
| Ford 1 214 912    | Ford 1 436 095    |
| Ford 1 436 097    | Ford 1 436 169    |
| Ford 1 436 170    | Ford 1 706 970    |
| Ford 1 706 971    | Ford 2N11-3042-AE |
| Ford 2N11-3042-AH | Ford 2N11-3051-AE |
| Ford 2N11-3051-AH | Ford 2S61-3042-AD |
| Ford 2S61-3042-AH | Ford 2S61-3042-AJ |
| Ford 2S61-3042-AK | Ford 2S61-3042-DA |
| Ford 2S61-3051-AD | Ford 2S61-3051-AH |
| Ford 2S61-3051-AJ | Ford 2S61-3051-AK |
| Ford 2S61-3051-DA | Mazda DD32-34-300 |
| Mazda DD32-34-350 |                   |

**Application info**

- |                                      |                            |
|--------------------------------------|----------------------------|
| Ford Fiesta V / Fusion (11/01-12/14) | Mazda 2 (DY) (02/03-06/07) |
|--------------------------------------|----------------------------|

**Suspension Kit**

716 610 0004

MCR0125

**Notes**

Front Axle Left  
 Front Axle Right  
 for control arm  
 with ball joint  
 with rubber mount

Required quantity  
 replacement in pairs recommended

2





**References**

The references of this product can be found at [www.meyle.com](http://www.meyle.com)

**Application info**

- |                            |                                  |
|----------------------------|----------------------------------|
| Ford Focus II (10/03--)    | Volvo C30 (09/06-12/13)          |
| Volvo C70 II (03/06-12/13) | Volvo S40 II / V50 (12/03-12/12) |

Suspension Kit		716 610 0005	MCR0126						
<p><b>Notes</b></p> <p>Required quantity replacement in pairs recommended</p>	<p>Front Axle Left Front Axle Right for control arm with ball joint with rubber mount</p> <p>2</p>								
<p><b>References</b></p> <p>The references of this product can be found at <a href="http://www.meyle.com">www.meyle.com</a></p>									
<p><b>Application info</b></p> <table border="0"> <tr> <td>Ford C-Max I (02/07-09/10)</td> <td>Ford Focus II (10/03--)</td> </tr> <tr> <td>Volvo C30 (09/06-12/13)</td> <td>Volvo C70 II (03/06-12/13)</td> </tr> <tr> <td>Volvo S40 II / V50 (12/03-12/12)</td> <td></td> </tr> </table>				Ford C-Max I (02/07-09/10)	Ford Focus II (10/03--)	Volvo C30 (09/06-12/13)	Volvo C70 II (03/06-12/13)	Volvo S40 II / V50 (12/03-12/12)	
Ford C-Max I (02/07-09/10)	Ford Focus II (10/03--)								
Volvo C30 (09/06-12/13)	Volvo C70 II (03/06-12/13)								
Volvo S40 II / V50 (12/03-12/12)									
Suspension Kit		716 610 0006	MCR0127						
<p><b>Notes</b></p> <p>Required quantity replacement in pairs recommended</p>	<p>Front Axle Left Front Axle Right for control arm with ball joint with rubber mount</p> <p>2</p>								

**References**

Ford 1 023 026	Ford 1 023 058
Ford 1 030 277	Ford 1 030 278
Ford 1 043 158	Ford 1 043 159
Ford 1 074 282	Ford 1 102 948
Ford 1 102 949	Ford 1 102 950
Ford 1 130 576	Ford 1 130 577
Ford 1 141 293	Ford 1 141 294
Ford 1 141 296	Ford 1 679 390
Ford 1 710 790	Ford 1 710 794
Ford 6 790 117	Ford 6 870 549
Ford 6 870 550	Ford 6 870 551
Ford 6 954 470	Ford 6 954 471
Ford 93BB-3042-BC	Ford 93BB-3051-BC
Ford 93BB-3395-AC	Ford 95BG-3A262-AA
Ford 95BG-3A262-BA	Ford 97BG-3042-AA
Ford 97BG-3042-BC	Ford 97BG-3042-CA
Ford 97BG-3051-BC	Ford 97BG3051AA
Ford 97BG3051CA	Ford 99BB-3395-AC
Ford ME93BB-3042-AA	Ford ME93BB-3051-AA
Ford ME93BB-3395-AA	Ford YS71-3042-AA
Ford YS71-3042-AB	Ford YS71-3051-AA
Ford YS71-3051-AB	

**Application info**

Ford Mondeo I, II (01/93-09/00)

**Suspension Kit**

716 610 0008

MCR0086

**Notes**

Front Axle Left  
 Front Axle Right  
 for control arm  
 with rubber mount  
 with wheel hub

Required quantity  
 replacement in pairs recommended

2



**References**

Ford 1 073 214	Ford 1 073 215
Ford 1 090 730	Ford 1 090 738
Ford 1 138 160	Ford 1 138 161
Ford 1 207 973	Ford 1 207 974
Ford 1 212 809	Ford 1 212 810
Ford 1 344 966	Ford 1 344 968
Ford 2M51-3042-BA	Ford 2M51-3042-BC
Ford 2M51-3042-BD	Ford 2M51-3042-BE
Ford 2M51-3051-BA	Ford 2M51-3051-BC
Ford 2M51-3051-BD	Ford 2M51-3051-BE
Ford 98AG-3042-AJ	Ford 98AG-3042-AK
Ford 98AG-3051-AJ	Ford 98AG-3051-AK

**Application info**

Ford Focus I (08/98-11/09)

**Suspension Kit**

716 610 0009

MCR0087

**Notes**

Front Axle Left  
 Front Axle Right  
 for control arm  
 with ball joint  
 with rubber mount

Required quantity  
 replacement in pairs recommended



**References**

Ford 1 518 904	Ford 1 520 778
Ford 1 521 773	Ford 1 532 421
Ford 1 532 433	Ford 1 540 724
Ford 1 540 725	Ford 1 700 809
Ford 1 700 810	Ford 1 708 222
Ford 1 708 226	Ford 1 712 696
Ford 1 712 697	Ford 1 737 305
Ford 1 737 309	Ford 8V51-3042-BA
Ford 8V51-3042-BB	Ford 8V51-3042-BC
Ford 8V51-3042-BD	Ford 8V51-3042-BE
Ford 8V51-3042-BF	Ford 8V51-3042-BG
Ford 8V51-3042-BH	Ford 8V51-3051-BB
Ford 8V51-3051-BC	Ford 8V51-3051-BD
Ford 8V51-3051-BE	Ford 8V51-3051-BF
Ford 8V51-3051-BG	Ford 8V51-3051-BH

**Application info**

Ford Fiesta VI (06/08--)